

The Magazine



Comics



Cool Creations



Activities



Poster



JAN - MAR | 2019



THE LEGO MOVIE VIDEOGAME



VIDEOGAME TIPS & TRICKS

USE THIS CODE TO UNLOCK SUPER COOL STUFF IN THE VIDEOGAME!
RUL4LU

Now you too can go on wild and whacky building adventures with Emmet and Lucy when you play THE LEGO® MOVIE 2™ Videogame! Check out these game tips and tricks to get started.

- #1 You can customize the look of your character at any time throughout your adventure! However, some characters will only speak to you if you're wearing the right outfit!
- #2 Scour the universe for special LEGO® Relics! Each one contains new characters, vehicles and LEGO sets to build!
- #3 The more of Emmet's friends you rescue, the more new special items you'll gain! Try returning to places you've been to previously and find new areas to explore!



THE LEGO® MOVIE 2™ © &™ The LEGO Group, DC Comics, WBEL. (s19) © 2019 TT Games Ltd. Produced by TT Games under license from the LEGO Group. LEGO, the LEGO logo, the Brick and the Knob configurations and the Minifigure are trademarks of the LEGO Group. ©2019 The LEGO Group. BATMAN and all related characters and elements © &™ DC Comics. All rights reserved.

WB GAMES LOGO, WBEL LOGO, WB SHIELD:™ & © Warner Bros. Entertainment Inc. (s19)





IN THIS ISSUE

ADMIT ONE

JAN-MAR 2019

These THE LEGO® MOVIE 2™ stars are all excited about the new issue of LEGO Life Magazine! Write what you think they are saying in the speech bubbles.



MAX COMIC

RRRRRIINNGGG!



WOW! TODAY'S THE DAY I GET TO SEE THE SNEAK PREVIEW OF THE LEGO® MOVIE 2! I CAN'T WAIT!

CLUT!



HUH? WHO? WHAT?



LET'S DO IT AGAIN. NEXT TIME, TRY TO BE MORE EXCITED, OKAY, MAX? ACTION!



LEGO® Life Magazine



PO Box 1138
Enfield, CT
06082



PO Box 600
Markham, ON
L3R 8G8

For information about LEGO® Life visit LEGO.com/life

For questions about your membership visit LEGO.com/service or call 1-877-518-5346

Apple and the Apple logo are trademarks of Apple Inc., registered in the U.S. and other countries. App Store is a service mark of Apple Inc. Google Play is a trademark of Google Inc.

THE LEGO® MOVIE 2™ © & ™ Warner Bros. Ent. Inc. & The LEGO Group. LEGO, the LEGO logo, DUPLO, the Minifigure and the Brick and Knob configurations are trademarks and/or copyrights of the LEGO Group. ©2019 The LEGO Group. BATMAN and all related characters and elements © & ™ DC Comics. All rights reserved. WB SHIELD: TM & © WBEI. (s19)



ARE YOU READY FOR THE NEW ISSUE OF LEGO® LIFE MAGAZINE, EMMET? IT'S PACKED FULL OF COMICS, PUZZLES AND FUN, PLUS LOTS OF THE LEGO® MOVIE 2™ ACTION!

AWESOME GETS AWESOMER!

MEET THE MOVIE STARS!



EMMET

Emmet is the **most caring**, upbeat and awesome guy in town, even if that town is now called Apocalypseburg.



LUCY

Also known as Wyldstyle, Lucy is a **skilled builder and fighter**, along with being Emmet's super best friend.



SWEET MAYHEM

This **mysterious** being from the Systar System captures Lucy, Unikitty™ and others. What's her secret plan?



WHICH CHARACTER FROM THE LEGO® MOVIE 2™ ARE YOU?

1. You're being chased by an alien spacecraft. You:

- a Try to scare it off by telling the aliens who you are
- b Build an escape vehicle from stuff you find around
- c Turn and wave hello to the aliens

2. You have to build something to save the day. You:

- a Build the coolest model you can using grey and blue bricks
- b Build the most awesome model ever out of pieces from other things
- c Build something that makes people go, "Huh?"

3. Things have gotten pretty tough in your town. You:

- a Spend most of your time in your cave
- b Get tougher and harder to make it through the day
- c Always have a smile for the sewer babies

ANSWERS:

If you answered mostly **a**, you're LEGO® Batman™! If you answered mostly **b**, you're Lucy! If you answered mostly **c**, you're Emmet!

©2019 Warner Bros. Ent. ©2019 The LEGO Group
© and ™ DC Comics



REX

Rex is an ultra-cool, **super-tough hero** who always knows just what to do.



UNIKITTY™

This mix of a unicorn and a cat is usually sweet, happy and sunny. But don't get her **angry**...



LEGO® BATMAN™

Batman™ is absolutely the **greatest** super hero ever! Just ask him.

MECH MISCHIEF!



BATMAN™ vs. **POISON IVY™** face off in their specialized mechs!

Here is Poison Ivy's review:

Retractable net shooter

Gripping leaf hands to catch Batman™!

MY THINGS HER MECH RULES, BUT, EH...NOT ENOUGH BLACK IN MY OPINION.

Spinning saw blade

Two stud shooters

BATMAN IS CERTAINLY TRYING HIS BEST... BUT NO ONE IS STRONGER THAN MY PRECIOUS PLANT POWERS!

Strong posable vines

My vines grow back even after Batman blasts them!



WANNA KNOW WHAT THE BEST PART OF THIS SET IS? MY OPENING COCKPIT. WHY? BECAUSE IT SHOWS ME.



SWEET MAYHEM SUDOKU!

Sweet Mayhem is piloting her Starship back to the Syster System, but she left this Sudoku puzzle behind for you to solve. Better hurry, before she comes back!

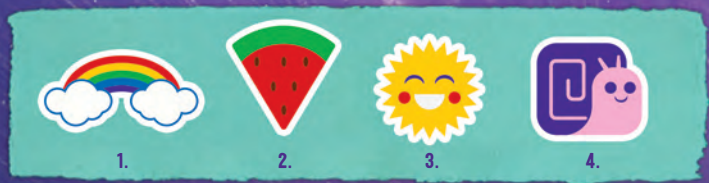

Each row, each column and each of the large four squares should have one of each sticker. Fill in the blanks!

	 4.	 2.	
 3.			 1.
 2.			 4.
	 1.	 3.	

BREAK THE UNIKITTY™ CODE!

Unikitty™ has morphed into her most ferocious form yet in THE LEGO® MOVIE 2™! Decode her new name below! Circle every third letter to figure it out!

K R **U** N H L S D
 T L B R J M A E
 E K T F A L H T
 D I T P L Y J N



U

Answers on page 25.



BUILD YOUR ESCAPE!



Lucy and Emmet have an Escape Buggy they can use to try to get away from Sweet Mayhem. But if she showed up in your town, what would you, your family and your friends use to make your getaway?

YOUR TASK

GRAB A BUILDING BUDDY AND BUILD YOUR VERY OWN ESCAPE BUGGY!

LIKE NOW. SERIOUSLY, SHE'S COMING.



Share your builds either by submitting to **Cool Creations** (see page 18) or posting in the **LEGO® Life app!**

EMMET'S RESCUE ROCKET!



Emmet's Dream House rebuilds into a Rescue Rocket capable of flying into space! We asked **LEGO® Master Builder Mark Roe** to take pieces from this set and show us different ways they could be used. Take a look at these pictures and see if you can match them with the correct name.



WHAT WOULD YOU BUILD? Try rebuilding a **LEGO model** into something else. You could even **challenge a friend** or family member to see who can do it faster!

1.



2.

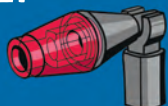

3.



4.



5.

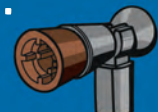

4

LAMP

ICE CREAM

MEGAPHONE

PLANT

LASER GUN

LEGO® MINECRAFT™

AAARRRGH-QUATIC ADVENTURE!

Welcome to the Ocean Biome! Follow the flowchart below to see how your adventure begins and ends! Good luck, matey!



START



You've arrived at the Ocean Biome!

Choose 1 of the 3 starting points below



Build a boat

OR

Drink a water-breathing potion

OR

Go for a swim

Go fishing

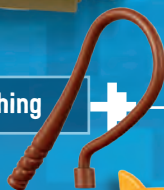

Catch a fish

Explore mysterious island

Meet dolphin



Meet turtle



Find a map



Meet parrot



Feed parrot

Feed dolphin raw fish

Discover turtle eggs

Use compass to find buried treasure





MINECRAFT



Arrr! Ye be a pirate now!

Fire the cannons!

Rebuild ship into a new boat

Dolphin leads you to a cool ship wreck

Befriend parrot

Dolphin leads you to treasure

You found gold!

Uh-oh! Zombies!!!

Run away!!!

Protect eggs - Yay, baby turtles!

You found gold!

SPIDER ASSIST!

STAY STILL SO I CAN GET YOU!

YOU NEED TO SAY PLEASE!

UH-OH, I'VE GOT TO STOP VULTURE BEFORE HE ESCAPES!

AW MAN!

THWACK!

I'M LATE TO THE BATTLE, BUT RIGHT ON TIME TO CATCH YOU!

ARGHH!

THANKS FOR THE HELP!

ANYTIME YOU NEED A HAND, OR EIGHT HANDS, GIVE ME A CALL!

THE EARTH DRILLER STRIKES AGAIN!

From out of the past thunders Cole's Earth Driller, a new version of the popular LEGO® NINJAGO® model from Season 2! Able to tunnel through mountainsides, the Earth Driller helped save the day when the ninja challenged the fierce Stone Warriors!



How much do you know about the original story in which the Earth Driller appeared? Take this quiz and find out!

- 1** TRUE or FALSE
The two major villains of the Season 2 story were Garmadon and the Overlord.
- 2** TRUE or FALSE
The ninja faced a powerful army of Steel Warriors.
- 3** TRUE or FALSE
The Earth Driller was built in NINJAGO® City.
- 4** TRUE or FALSE
In the story, the ninja team is trying to reach the Temple of Light.
- 5** TRUE or FALSE
At the end of the story, Lloyd becomes the Golden Ninja.

Answers on page 25.

GOLDEN WEAPONS OF SPINJITZU

In their first adventure, the ninja team had to retrieve the Four Golden Weapons of Spinjitzu. They were:

- 1** The Scythe of Quakes
- 2** The Sword of Fire
- 3** The Nunchuks of Lightning
- 4** The Shurikens of Ice

These weapons would go on to play a part in many NINJAGO tales! Look for all four of the Golden Weapons in the new line-up of LEGO® NINJAGO Legacy models.



ESCAPE THE EMPIRE!



Help Luke and Leia escape the Death Star™ by solving this LEGO® Star Wars crossword puzzle!

DOWN

1. Millennium _____
2. Luke's last name
3. C-3PO™ and R2-D2™ are _____
7. _____ Solo
8. Luke's sister, Princess _____

ACROSS

4. Chewbacca's species name (starts with W)
5. Ice planet from *The Empire Strikes Back*
6. Black-armored villain of the *Star Wars* movies
8. Young Jedi who destroyed the Death Star

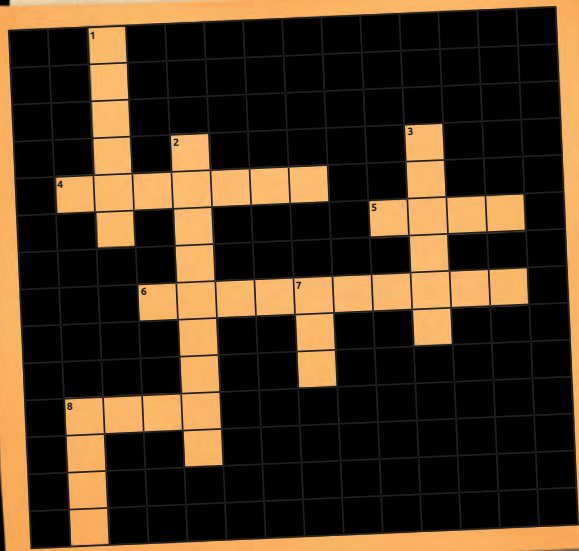

TEST YOUR STAR WARS™ KNOWLEDGE!



Can you answer these four *Star Wars* trivia questions before the Droid Gunship catches up to Yoda™ and Chief Tarfful?

1. Name one of the two most recent *Star Wars* movies. _____
2. True or False: Lightsabers only come in two colors, blue and red. _____
3. Complete the sentence: "May the _____ be with you." _____
4. Luke first meets Yoda on what planet? _____

STUNT POWER UNLEASHED!

What's that tearing through rough terrain on its wide tracks? It's going backwards, forwards, spinning and... popping a wheelie? It's the new Remote-Controlled Technic™ Stunt Racer, created by LEGO® designers with "wow" in mind.



TECHNIC™



WHEELIE FUN FACTS

- 1 A wheelie is also called a wheelstand.
- 2 Wheelies are easiest to do when a vehicle has just started moving.
- 3 The first wheelie is believed to have been performed by a stunt bike rider in 1890.
- 4 Although wheelies look awesome, they can be dangerous. Don't try to do one without lots of training and practice - unless it's with the Technic™ Stunt Racer!

Two Technic™ Stunt Racers challenge each other in a game of Car Soccer! Which can drive the ball into the other's goal? It's all-out action in this exciting video in the #Technic group in the LEGO® Life app!





THE LEGO MOVIE





THE LEGO® MOVIE 2™ © & ™ DC Comics, Warner Bros. Entertainment Inc. & The LEGO Group. LEGO, the LEGO logo, DUPLO, the Minifigure and the Brick and Knob configurations are trademarks and/or copyrights of the LEGO Group. ©2019 The LEGO Group. BATMAN and all related characters and elements © & ™ DC Comics. All rights reserved. WB SHIELD: TM & © WBEI. (s19)



LEGO® Life + THE LEGO® MOVIE 2™ =



YOUR STUFF HERE



EmperorVibrantTurnip



SargeantEnchantingShrimp



AuntInspiringGirl

© 2019 Warner Bros. Ent. © 2019 The LEGO Group © and TM DC Comics



AWESOME ENOUGH FOR YOU?

AND THESE ARE OUR MEMBERS PAGES, WHERE YOU CAN SEE AMAZING THINGS LEGO® FANS HAVE SENT TO US FROM ALL OVER THE WORLD.



The Bounty of The Galaxy

Dear Max,
Thank you for the magazine, I love it so much. I am a LEGO Star Wars fan. I build a lot. My favorite bounty hunters are IG-88 and Zuckuss. I have their minifigures.



I also built a huge ship named The Bounty of The Galaxy. I have enough bricks because I have 16,000,110,045 LEGO bricks.

Your friend,
Abraham, US, age 6





Lina, Alexis, France, age 8

Drawn by Toby, UK, age 7

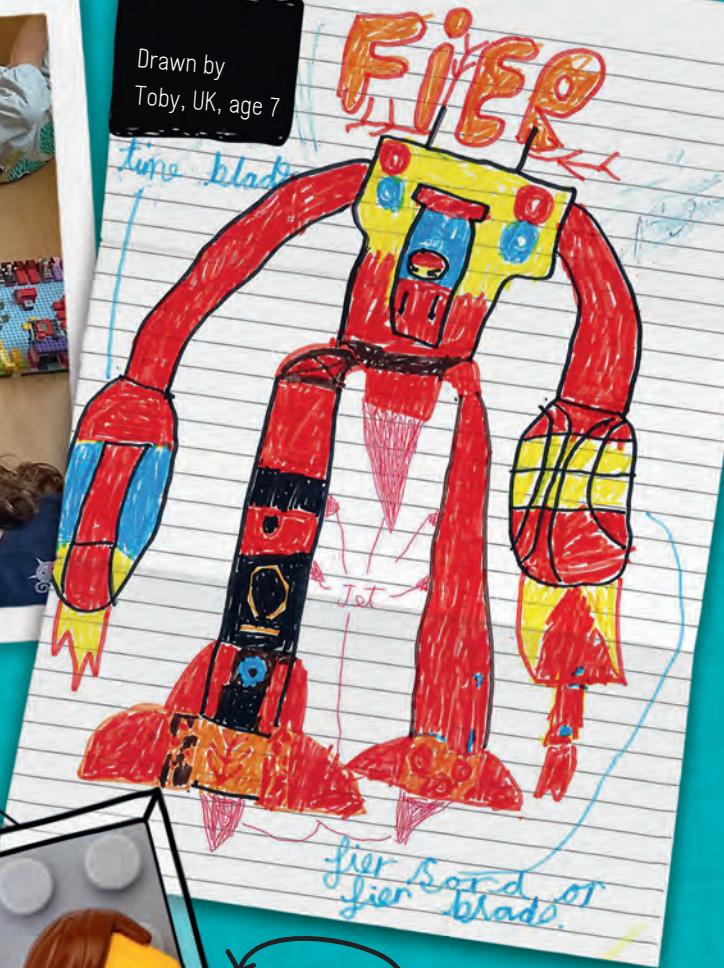

Drawn by Ubayah, UK, age 6



From EnsignFriendlyGirl



PETS CORNER
STARRING
MissSpontaneousChocolate

WE WANT TO HEAR FROM YOU!

Send Us:

- * A letter to Max!
- * A drawing or painting
- * Any LEGO® questions
- * Your funny jokes!

WRITE TO: LEGO Life by sending us an email - go to LEGO.com/life and select 'Magazine' to read how!



13



222

COOL CREATIONS

WILL YOU BE IN ONE OF OUR NEXT MAGAZINES?

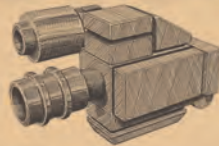

Check out these awesome models made by kids like you from all around the world!

Share what you've been building! Find out how you can send in your photo by going to LEGO.com/life and selecting 'Magazine'. It's easy and fun, and maybe your Cool Creation could appear in a future issue of the magazine!



The Big Hot Dog Sky
 Ida, age 6, Denmark



Small City
 Leevi, age 7, Finland



Ultimate Grievous
 Mikolaj, age 9, Poland

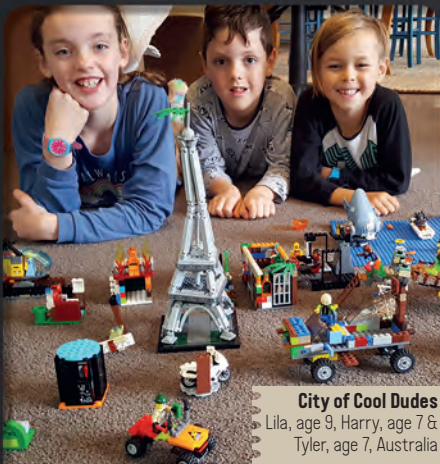

City of Cool Dudes
 Lila, age 9, Harry, age 7 & Tyler, age 7, Australia



Jail Swimming Pool
 Anabia, age 6, United Kingdom



The Crazy Town
 Thomas, age 7, United States



Chameleon
 Jamnik, age 8, Denmark



The Big LEGO Friends City
 Anabelle, age 9, France



Ocean House Light House
 Nicholas, age 6, Australia





Girls' Clubhouse
Mara, age 8 and
Misha, age 9, Netherlands



Hoppy Bouncy Castle
Maja, age 6, Denmark



Pirate Camp with Lighthouse
Noah, age 6, Germany



Pug House
Lily, age 6, Australia



The Lion and the Rhinoceros
Ilmothe, age 9, France



Minecraft Winter
Mads, age 7, Denmark



Fort of the Incomparable
Tristan, age 9, Canada



Claybot
Charlie, age 7,
United States



Garmadon's House
Viggo, age 7, Sweden



Monster Attack
Archie, age 9, United Kingdom

CUT!
LET'S CHECK
OUT THESE AWESOME
CREATIONS!



WHAT'S IN THE BOX!

Match the accessories with the Friends Heart Box they belong in!

Each of the Friends girls are giving you clues about what should be in their box!



Emma

You're beautiful!
Can I draw your
portrait?

Stephanie

Sunny days
are for sports!
Let's go play
outside!



Olivia

I need your help
programming
my latest
invention!



A SEA OF JOKES!

Laugh till your gills hurt with these fishy, funny jokes!

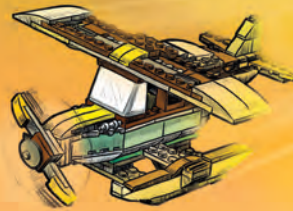

Why do fish swim?

They don't have legs to walk!



Where would you find an octopus?

The same place you lost it!



Where can you find an ocean without water?

On a map!

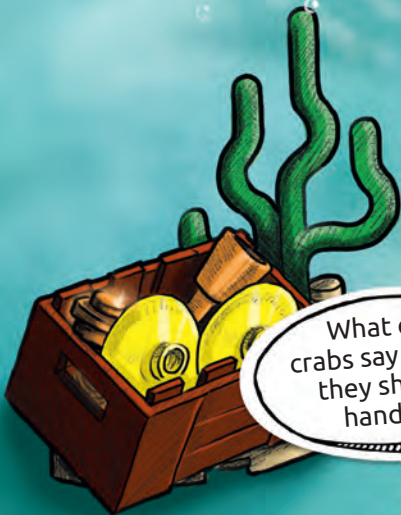

What do crabs say when they shake hands?

Ouch!



Why are there so many bubbles in the ocean?

Because all the fish are farting!



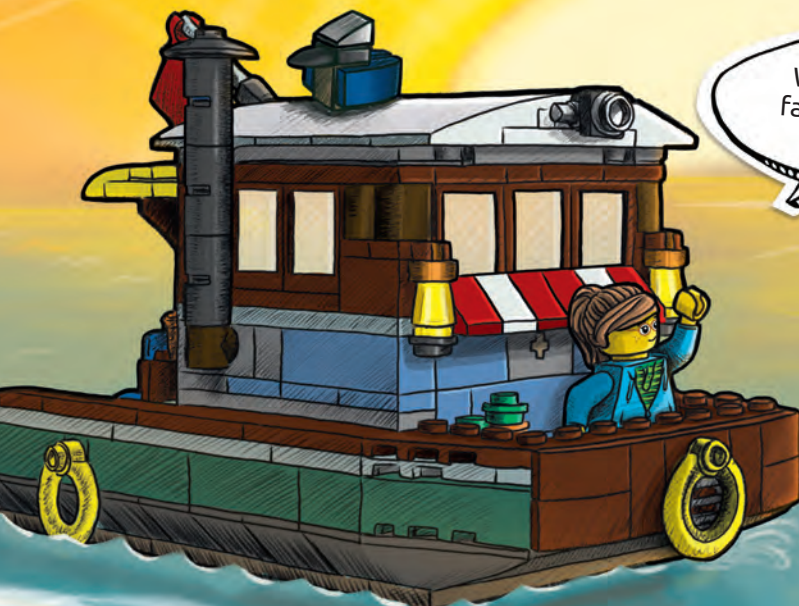

What always falls but never gets hurt?

Rain!



What is a knight's favorite fish?

A swordfish!

Why do whales swim in salt water?

Pepper makes them sneeze!

TREASURE HUNT!
A chest full of gold coins fell off the boat! Search the scene to find all 12 coins!

Answers on page 25.



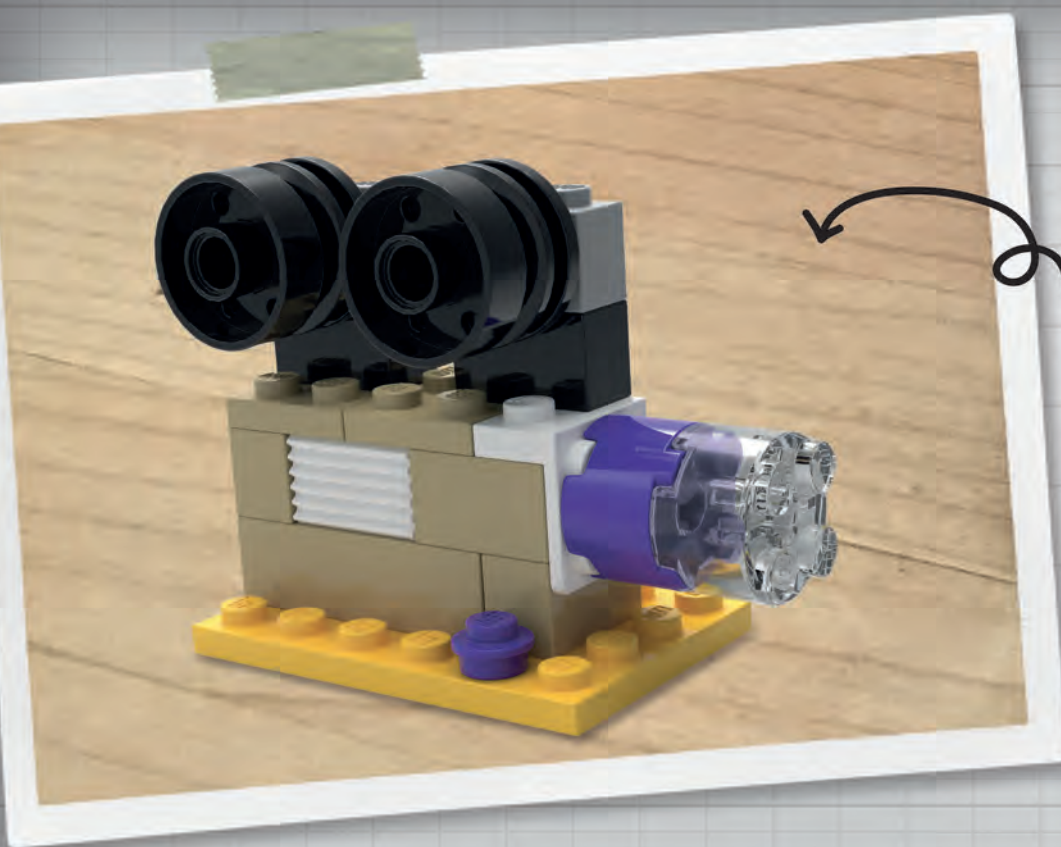

Build a movie projector for your very own cinema!

You can build this incredible model using LEGO® set 10698 Large Creative Brick Box or pieces from your own LEGO brick collection. Then invite your favorite minifigures to a movie show!

LIGHTS, CAMERA

LEGO® FUN!

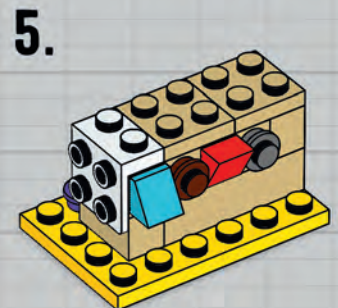
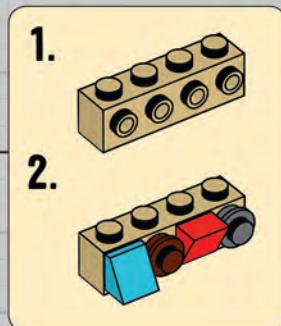
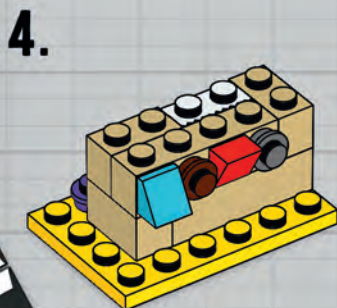
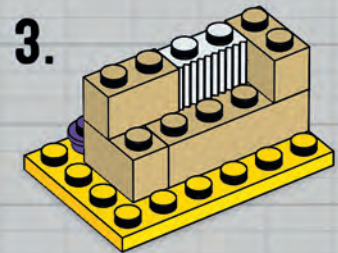
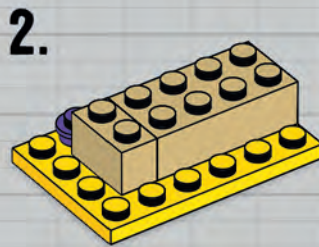
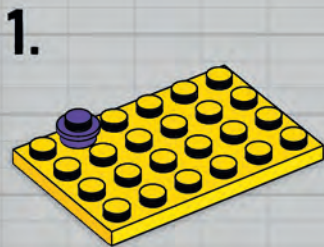

6.

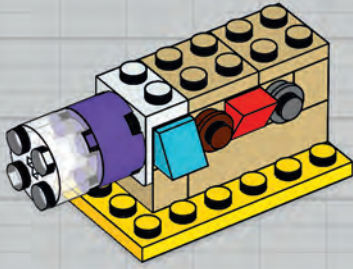
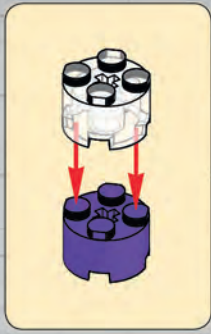

7.

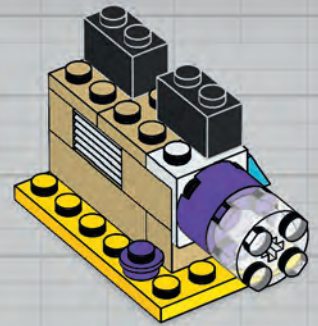

8.

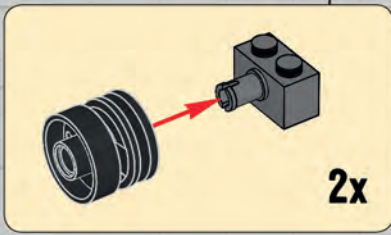

2x

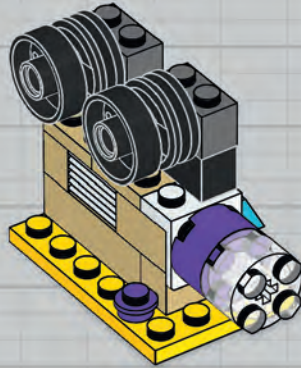

THE LEGO® MOVIE 2™: Pg. 6-7



Break the Unikitty™ Code!
Ultrakatty

Emmet's Rescue Rocket:

1. Ice Cream
2. Laser Gun
3. Plant
4. Lamp
5. Megaphone

LEGO Friends™: Pg. 20-21



LEGO NINJAGO™: Pg. 11

1. True
2. False
3. False
4. True
5. True

LEGO Star Wars™: Pg. 12



1. The Last Jedi and Solo
2. False
3. Force
4. Dagobah

ANSWERS



LEGO Creator 3-in-1™: Pg. 22-23



LEGO | Disney Princess™: Pg. 26

Quest for the Rose:
The Rose is in her bed

Ariel's Dolphin Puzzle:

1. Blowhole
2. Flipper
3. Pod
4. Fin
5. Swim

LEGO® | DISNEY PRINCESS™ PUZZLE DAY!



Quest for the Rose!

Aurora has lost her rose somewhere in her castle. It will take all day to search for it! Give her a hand by filling in the message using the letters in this picture. We even started it for you!

T D E O
S E N H

H R S
I I E R
B E

Help Ariel solve this dolphin puzzle!

Ariel is out for a fun ride on her dolphin carriage. Her finny friends have scrambled these words and asked her to fix them. All of the words have something to do with dolphins. To help you out, we provided some hints! Can you help her?



1. EWBLOOHL B _ _ _ _ H _ _ _
(Hint: They use this to breathe)

2. PIFEPLR _ _ _ _ P P _ _ _
(Hint: They use them to swim)

3. DPO _ _ O _ _
(Hint: Friends and family they travel with)

4. INF F _ _ _
(Hint: On top of their bodies)

5. MISW _ _ W _ _ M _ _
(Hint: They do this ALL day)



Answers on page 25.

~ Main Course ~

~ Desserts ~

~ Drinks ~

Tiana's Menu Mania!

Tiana would like your help designing the menu for her new restaurant.

Give it your own personal touch by adding what you would want to have on the menu.



Battling Blazes!

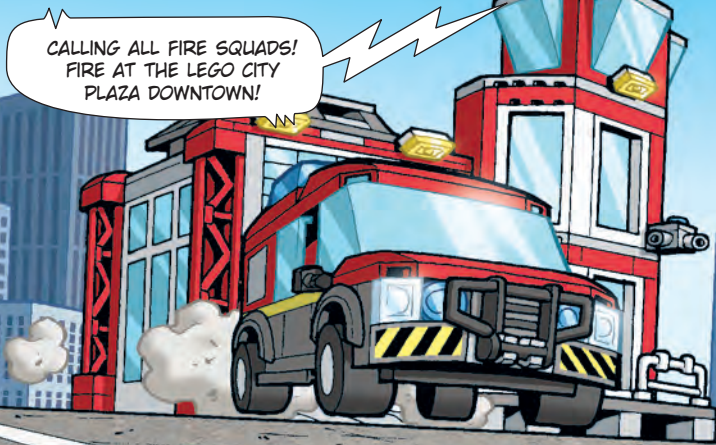

CALLING ALL FIRE SQUADS!
FIRE AT THE LEGO CITY
PLAZA DOWNTOWN!

FOR THE LEGO CITY FIRE DEPARTMENT, EVERY DAY BRINGS NEW DANGER AND ADVENTURE.

FROM EVERY CORNER OF TOWN,
THE BRAVE FIREFIGHTERS
ANSWER THE CALL.



UH-OH!
NOW THAT THIS
BARBECUE FIRE IS OUT,
I BETTER HEAD
TO THAT BLAZE!



THAT'S A BIG FIRE!
WE'LL NEED LADDERS,
THE WATER PUMP, HOSES,
AXES, HELMETS -

MARSHMAL - HEY,
WAIT A MINUTE!

MARSHMALLOWS!

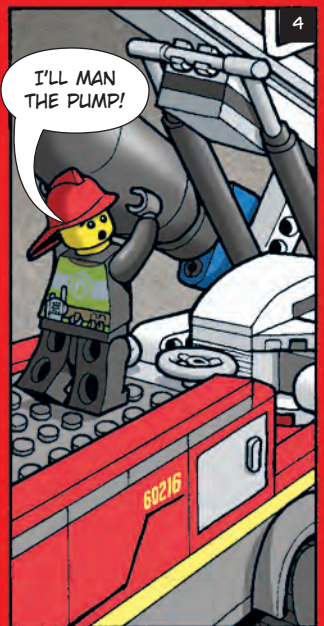

I'LL MAN
THE PUMP!



Splooosh!

KEEP IT UP!
WE NEED ALL
THE WATER WE
CAN GET!



GREAT! THE FIRE
IS GOING OUT AND
NOW I DON'T NEED
TO TAKE A BATH
THIS WEEK.

STORY CONTINUES

Next issue of LEGO® Life Magazine out in April 2019!

