

THE MAGAZINE

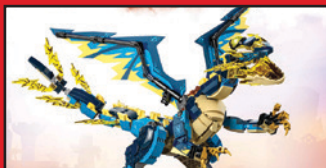

COOL CREATIONS



ACTIVITIES



COMICS



NEW LEGO MODELS

WELCOME TO ISSUE 5!

HI, IT'S MAX!
THE FESTIVE SEASON
IS HERE! JOIN US
IN BUILDING HEARTS
AND SHARING THE
SUPERPOWER OF PLAY!

WHAT KIND OF
HEART WILL YOU
BUILD?

IT'S HOT
HERE... I
BETTER
MOVE!

MY HEART CAN
BRIGHTEN THE
NIGHT!



THE ADVENTURES OF MAX



ARE YOU PUZZLED?

Look for these bricks on activity pages. They will tell you if the activity is easy, hard, or somewhere in-between. Try them all and see how you do! **If you get stuck, all the answers can be found on page 27.**



LEVEL 1
Easy



LEVEL 2
In-between



LEVEL 3
Hard

FIND THE PET FRIENDS!

The puppies or the dogs will direct you to the activities and stories that have been created especially for you!





Rebuild
the
world™

**TELL MAX WHAT
YOU THINK OF THIS
MAGAZINE!**

Ask a parent or guardian
to **scan this code** or visit
LEGO.com/LIFESURVEY
to take the survey right away!

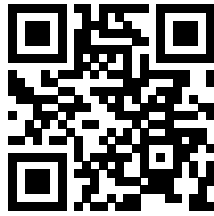

**Check out this cool
stuff inside!**

**New
comic**
Pages 4-5



**Amazing
challenges**
Pages 12, 17, 23



Get inspired
Pages 6, 22, 26-27



**And much,
much more!**



LEGO® Life Magazine

For information about LEGO® Life visit **LEGO.com/life**

For questions about your membership visit **LEGO.com/service**
or call **1-877-518-5346**

 PO Box 1138
Enfield, CT 06082

 PO Box 600
Markham, ON
L3R 8G8

(US/CA)

LEGO, the LEGO logo, DREAMzz, the DREAMzz logo, the FRIENDS logo, NINJAGO, the NINJAGO logo, the Minifigure and the Brick and Knob Configurations are trademarks and/or copyrights of the LEGO Group.
©2023 The LEGO Group.
All rights reserved.



THE FRIENDSHIP PARTY

CAN'T WAIT TO SEE WHAT MY FRIENDS CREATE!



TEE HEE

WHY HAS NO ONE SHOWN UP YET? HAVE I DONE SOMETHING WRONG?

SHHHH

SHHHH! HEHEHE



THANKS, BUDDY. YOUR PINATA HAS INSPIRED ME TO MAKE ANOTHER ONE!

WAAAAIT...



I FEEL A BIT DISAPPOINTED, BUT I AM GLAD THAT WE ARE BOTH HERE. LET'S OPEN UP YOUR PINATA!

WOOF!

WOOF! WOOF!

GOOOO!



SURPRISE!

HAHA, MAX'S FACE!



WOW, YOU WERE HERE ALL ALONG! THIS IS THE BEST SURPRISE EVER!

WHO TURNED OFF THE LIGHTS?



KNOCK! KNOCK!

I'LL GET IT!



SORRY WE'RE LATE, MAX!

WE WANTED TO MAKE A PIÑATA THAT YOU'D REALLY LOVE. GUESS WE LOST TRACK OF TIME!

AND WE MADE COOKIES!

I'M SO GLAD YOU'RE HERE! I CAN'T WAIT TO SEE WHAT'S IN YOUR PIÑATA!



THANKS FOR LETTING US BRING OUR KIND OF FUN.

TOTALLY! I WANTED TO CELEBRATE EVERYONE'S COOL IDEAS. AND I LOVE ALL OF YOUR PIÑATA SURPRISES!

DANDELIONS?! SOME RABBIT SWEETS. NICE!

WHAT DID I MISS?!



YOU ARE INVITED TOO! BUILD A PIÑATA FOR YOUR FRIENDS WITH ANY LEGO® BRICKS YOU HAVE!

It's Kindness Week!
Visit [LEGO.com/kids/digital-safety](https://www.lego.com/kids/digital-safety) to learn more about being kind online.

COOL CREATIONS

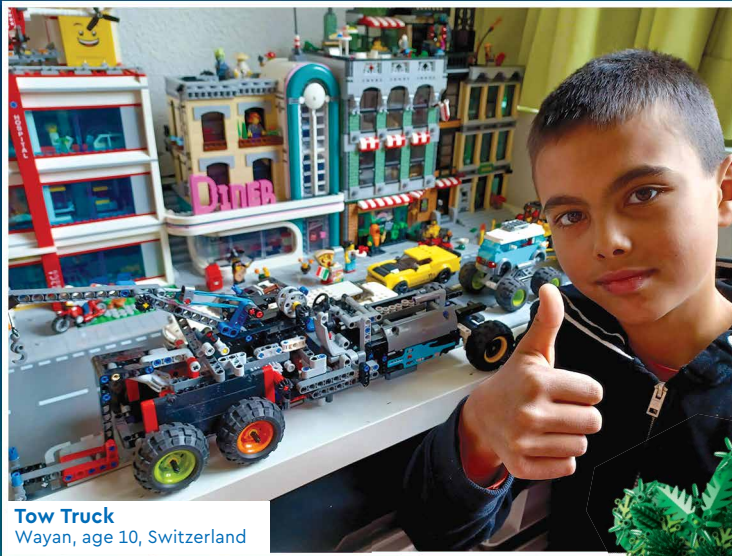

Tow Truck
Wayan, age 10, Switzerland



"Be Happy" Cat DOT Art
Madison and Taylor,
age 8 and 6, Canada

Do you have an **AWESOME BUILD** you would like to share with other builders?

SEND US YOUR PHOTO!

- 1 Have a **photo taken of you with your build**. You might see it on this page in a future issue.
- 2 Ask a parent or guardian to go to [LEGO.com/cool-creations](https://www.lego.com/cool-creations).
- 3 There they can **download and complete the Submission Form**, then email it along with your photo. See the Submission Form for the email address.
- 4 Remember that you can send us a story about your model too. Tell us how you built it, what's going on in the scene, or whatever you like. Max also loves getting your letters!



Dream Beach House
Ludwig and Pia,
age 6 and 8, Germany

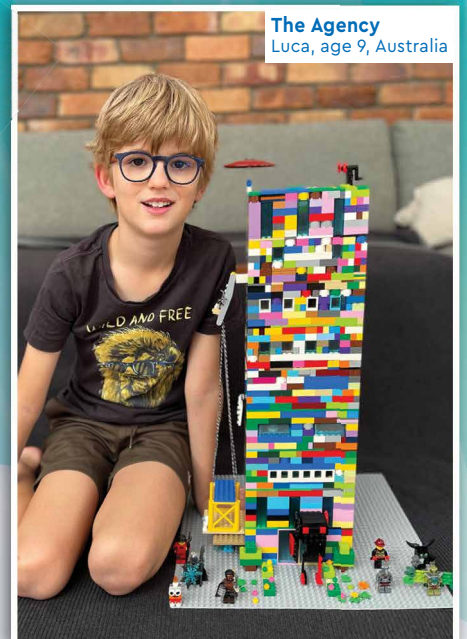

The Agency
Luca, age 9, Australia



THANKS TO EVERYONE WHO SENT IN THEIR CREATIONS, INCLUDING ISABELLA, THOMAS, OLIVER, NORMA, AIDEN AND SHARDUL. YOU ROCK!

The Ultra Mech
Peter, age 11, USA



Dinosaur Attack on LEGO City
Ava and Shay, age 10 and 8, Ireland



Police Station
Emily and Andrew,
age 6 and 4, USA

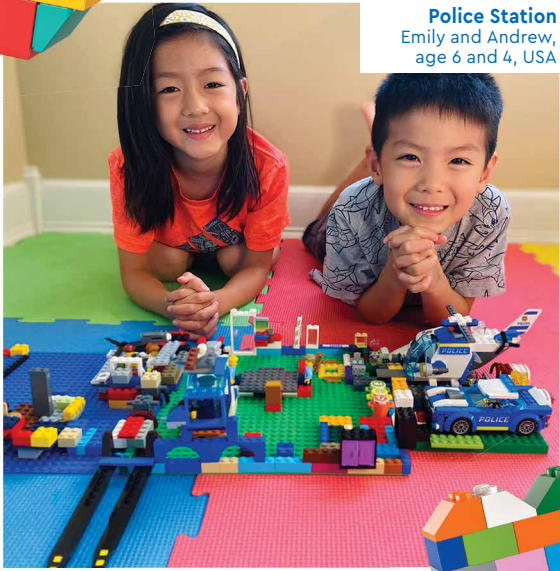

Barn & Fun Shop
Joseph, Rosalie and Xavier,
age 7, 9 and 4, UK



Clothing Store
Alessandro, age 6, Italy



My Stylish Glasses
Raphaël, age 7, France



Dear Grown-Ups!
You can submit a photo by filling out the form on LEGO.com/cool-creations.

**Rebuild
the
world™**

THE WONDERS OF THE CROCODILE CAR



IT'S YOUR TURN TO DREAM CRAFT!

If you were a dream crafter, what dream creature would you create? Draw it or use your LEGO® bricks to build it!

DONKEY KONG'S TREE HOUSE FUN!



 The Donkey Kong™ crew have a lot of laughs in the LEGO® Super Mario™ Donkey Kong's Tree House set. So much so that things are flying around now! Can you put them where they belong? Write the number of each missing piece in the empty space.



BANANA QUEST

Donkey Kong needs your help finding all of the yummy bananas. Let's get searching!

TO THE FINISH LINE!



Desert races are some of the hardest off-road driving contests in the world. Only the toughest drivers make it to the finish line. The electric Audi RS Q e-tron is fit to tackle the challenge. Ready to test it? Let's see what it can do!

DRIVE IT WITH THE LEGO® TECHNIC™ CONTROL+ APP

Use your phone to help the Audi RS Q e-tron conquer any obstacles!

ACCELERATION

From 0 to 60 mph in under 4.5 seconds!



POWERFUL ENERGY CONVERTER

To charge the high-voltage battery while you race.



GAME INSTRUCTIONS:

- Invite a friend to the game.
- Choose a LEGO® brick as a playing piece.
- Get an additional **20 bricks**. These are your electric power.
- The youngest player goes first.
- As you go, here are your choices:
 - Move one square, lose one brick.
 - Move two squares, lose three bricks.
 - Move three squares, lose five bricks.
- Switch turns after each go.
- Pay attention to special fields and follow the instructions.
- The first player to cross the finish line wins. If both players lose all power during the game, the player who drove furthest wins.

Special fields:



Accelerate for a shortcut!
Lose **FOUR** bricks



You got stuck!
Lose **FOUR** bricks



Cool advantage!
CONTROL+ app allows you to move **ONE** square



Obstacle on the road!
Wait **ONE** turn



Charging station!
Add **THREE** bricks or wait **ONE** turn and add **SIX** bricks



Road closed!
Go back and try another route

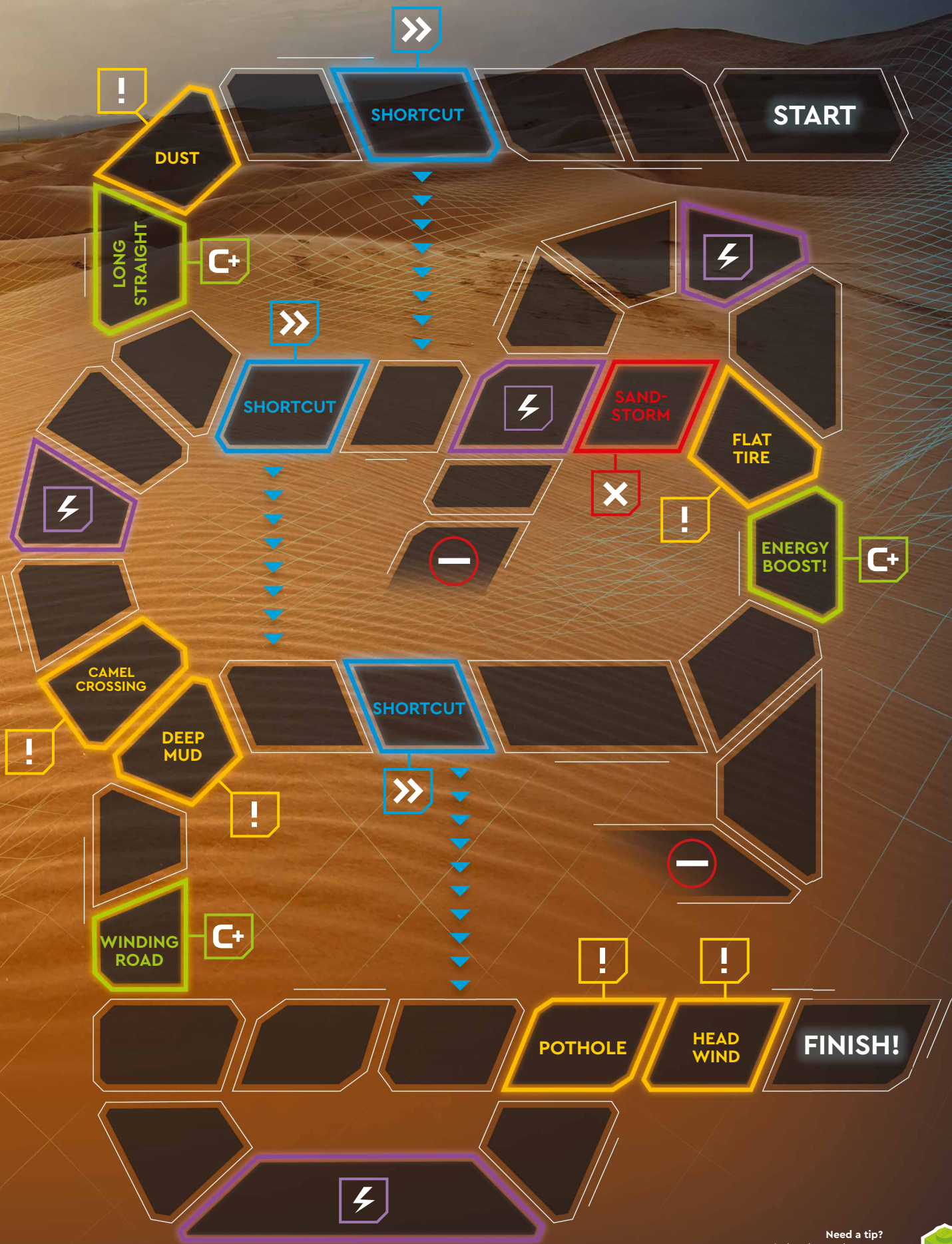

Need a tip?
For tried and tested routes,
turn to page 27.

POWER UP YOUR DRAGON!

Sora is facing Beatrix's mech in an epic battle, but she's not alone! She has her skills, loyal friends and a mighty dragon by her side. How about making it even stronger?



CREATE AN UNDEFEATABLE DRAGON

Select new skills for your dragon! Using your favorite colored pens or pencils, draw the upgrades and create your own awesome creature!



Extra spikes



Fire



Mace tail



Thunder roar



Light beam



Energy shield





STAR WARS
THE

MANDALORIAN





Disney

Give Wonder

Disney
100





A MIX-UP AT WEASLEYS' WIZARD WHEEZES™!



Oops! Someone has slipped and spilled the Peruvian Instant Darkness Powder all around Diagon Alley™. In the chaos, many magical items got lost.

HELP THE WEASLEYS

Try to find all the missing things.



-  **OWL POST™ X2**
-  **LOVE POTION**
-  **FANGED FRISBEE**
-  **PYGMY PUFF™**
-  **WEASLEYS' WILDFIRE WHIZ-BANGS**

Do you need some help?
Check page 27 for answers.

WIZARDING WORLD and all related trademarks, characters, names, and indicia are © & ™ Warner Bros. Entertainment Inc. Publishing Rights © JKR. (S23)

PYGMY PUFF™ CHALLENGE

They are cute, adorable creatures. Now you can make your own! Get your crayons ready and decorate it just the way you like. You can also add some cool accessories.



TROUBLE IN THE MULTIVERSE



MARVEL STUDIOS
SPIDER-MAN
No Way Home



Swing into action with the Spider-Men! The portal opened the way to two new multiverses. Only the top one is original. Can you spot six differences between the two copies below?

Need help? Answers can be found on page 27.



ORIGINAL



MULTIVERSE 1



MULTIVERSE 2

SPIDER-MAN,
YOU NEED TO
UNTANGLE THIS
RIDDLE!



WHICH ONE DO
YOU MEAN?



I THINK HE
MEANS ALL OF US!



SOLVE THE ENIGMA



Indy and his father are being chased by the villains. While they are trying to escape, help them decode a telegram to find Professor Jones's journal.



I'M LOST WITHOUT MY JOURNAL!

WE'LL GET IT BACK. HOLD ON TIGHT!

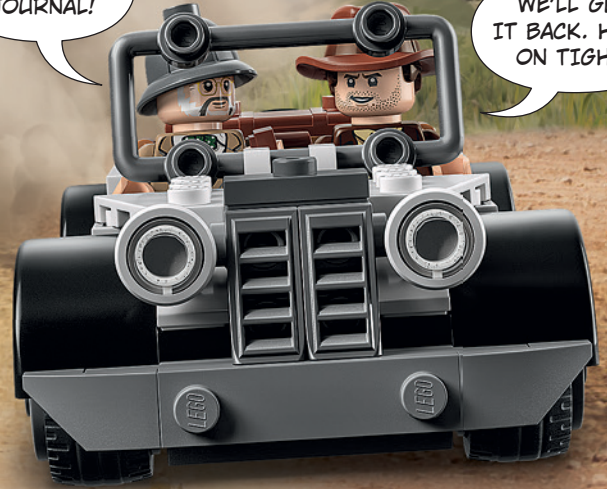

Telegram Cypher

Use the key below to crack the code.

A	B	C	D
..	---	---	---
E	F	G	H
.	...	---	...
I	J	K	L
..	---	---	---
M	N	O	P
---	..	---	---
Q	R	S	T
---	---	...	-
U	V	W	X
...	---	---	---
Y	Z		
---	---		

Decode the telegram using the cypher. The last city is where the journal is now:

□	□	□	□	□	□
...	.	-	..	---	.
□	□	□	□	□	□
---	..	---
□	□	□	□	□	□
...	---	..	---
□	□	□	□	□	□
...	---	---

CAN YOU SOLVE IT?



Need Help? Answers can be found on page 27.

CITY SPORT CHALLENGE



Welcome to the LEGO® City Ski and Climbing Center! Discover which activity best suits you by taking this quiz. Circle your answers and check the results.

C'MON DAREDEVILS, LET'S TEACH YOU SOME SKILLS.



QUESTION 1

What do you love about the festive season?

- A. BEING OUTSIDE
- B. TRYING OUT NEW THINGS
- C. TIME WITH FRIENDS AND FAMILY

I LIKE DANCING ON ICE!



QUESTION 2

How do you like to explore new places?

- A. IT'S BEST ON A VEHICLE
- B. I WANT TO SEE EVERYTHING
- C. I LIKE TO SIT DOWN AND LOOK AROUND



QUESTION 3

What do you like best about sports?

- A. JUST WANNA HAVE FUN
- B. THE COMPETITION
- C. BEING TOGETHER

IT'S A GREAT VIEW FROM THE TOP!



QUESTION 4

What scenario sounds best to you?

- A. GOING DOWN A MOUNTAIN
- B. HEADING UPWARDS
- C. FLAT SURFACES, PLEASE

RIDING UP A MOUNTAIN IS THE BEST THING EVER!



QUESTION 5

How do you like to play?

- A. SOLO, PLEASE
- B. PAIR ME UP AND LET'S SEE WHO'S BETTER!
- C. THE MORE, THE MERRIER

RESULTS:

Mostly A

It's all about tricks and fun! Grab your skis or a skateboard and let's go! Or try building a snowman or a sandcastle.

Mostly B

Adventure is calling! Try ice hockey or climbing a rock wall. A little added challenge can be exciting.

Mostly C

Enjoy some good company! Try sledging or biking with a friend, or relax with a cup of cocoa.

GALACTIC PHOTO SHOOT

It's picture time! Bring your favorite LEGO® Star Wars™ minifigures or creations to mingle with the legendary Darth Vader™, Boba Fett™ and Stormtrooper™ Mechs to make stellar memories.

Photo lesson in 3 steps:



1. Bend the page along the dotted line to divide it into the 'ground' and backdrop.



2. Place your cool creations or minifigures on the 'ground' you created.



3. Get your camera, turn on the lights and snap away!

Dear Grown-Ups!

This is a good place to jump in and help with the camera gear and set-up! You can also help send the pictures to Max.

Check page 6 for details.

HAVING FUN WHILE EXPERIMENTING IS THE BEST WAY TO LEARN GREAT PHOTOGRAPHY!

LEGO STAR WARS



BEND HERE

SPACE FUN

What would you do in a space amusement park?
You decide! Read about the attractions and put the
rides in the order you would like to visit them.



■ SATELLITE



■ SATURN

■ METEOR



RIDE ONE

Hop on a Space Roller Coaster and zoom between planets, rockets and stars. Can you spot the three items shown on the page?



RIDE TWO

Feel the thrill of the space rocket launch! It won't start due to a computer glitch. Trace the circuit lines from the **INPUT** to the **OUTPUT** to fix it.

INPUT

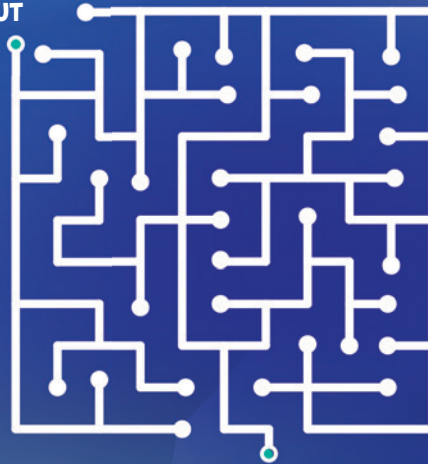

OUTPUT



RIDE THREE

The space carousel is so fast that the world can become blurry! What's that shape? Connect the dots to find out.

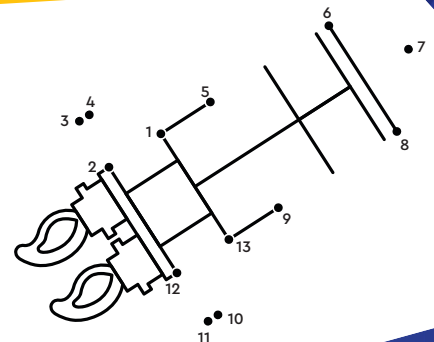

SONIC'S AMAZING LOOP RACE



Help Sonic the Hedgehog™ find the path through the grass maze and outsmart Dr. Eggman. Pick up speed and fly through the loop-de-loop before freeing Amy and the animals at the finish line.



Play the new LEGO® Sonic the Hedgehog™ game on LEGO.com/kids.



START



Do you need some help? Check page 27 for the answers.

©SEGA. All rights reserved. SEGA is registered in the U.S. Patent and Trademark Office. SEGA and SONIC THE HEDGEHOG are either registered trademarks or trademarks of SEGA CORPORATION.

FINISH

A DAY IN PICTURES

It's snowboarding time! Autumn and Liann had a great day on the slopes. What did they do?



MEMORY QUEST

The photos are all mixed up. Can you put them in the right order? We have done the first one for you!



1

It was a sunny morning. We arrived at the ski slope. Snow was everywhere!



Before bed, we relaxed by the fire. It was a really lovely day!



In the morning, we climbed the mountain and went snowboarding.



SPYING ANIMALS

Many wild animals live in the mountains. Liann and Autumn caught some of them in the photos! Count how many times they appear.

_____ Bird

_____ Fox



WHERE IS LIANN'S SNOWBOARD?

Liann lost her snowboard. Can you help her find it in one of the photos?

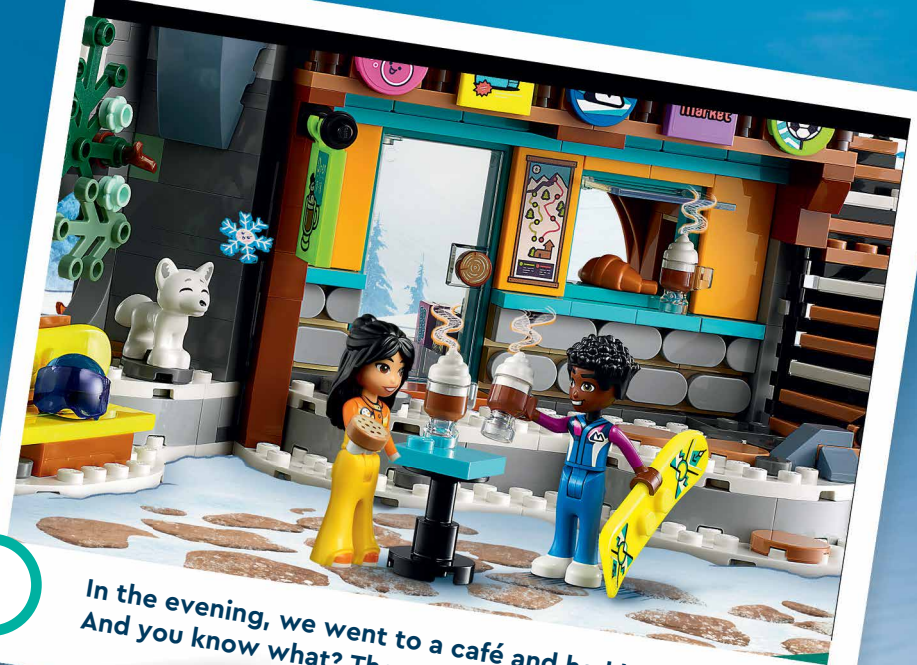

In the evening, we went to a café and had hot chocolate. And you know what? The snow fox followed us!



After we got to the café, we took a selfie on the balcony.



We saw a snow fox on the top of the mountain!



CRACK THE CODE

Liann wrote a note to Autumn backwards. Can you decode the message?

!NUF FO TOL A SAW YADOT

Need Help? Answers can be found on page 27.

CREATE AS IF IN A DREAM

Have you ever wanted to dream craft like Mateo, Izzie and Cooper? Now you can! Follow their guide on how to create dream creatures, grab any LEGO® bricks you have, and bring your dreams to life.

A SNAKE
SLITHERING IN
THE SKIES... OR
WEARING RUNNING
SHOES.



I HAVE ALWAYS
DREAMT OF A
MOBILE HOME.
NOW,
THAT'S THE WAY TO
TRAVEL!





THERE'S NO LIMIT TO YOUR DREAMS! YOU CAN GIVE THEM WHEELS, WINGS... OR MAKE THEM SUPER CUDDLY!

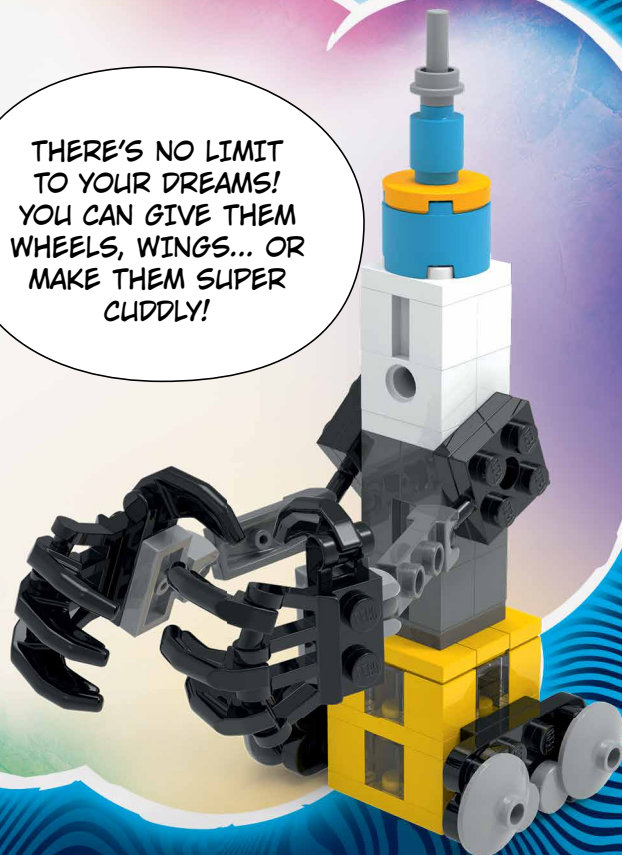

Look for more inspiring building instructions in the free LEGO® Builder app!

- Save your sets
- Zoom in and rotate your model while you build
- Track your building completion!



Don't forget to ask a grown-up's permission before downloading apps.

LEGO Friends, p. 24–25:



Four foxes Three birds

Crack the code:
TODAY WAS A LOT OF FUN!

LEGO Sonic the Hedgehog™, p. 23:



LEGO Creator, p. 22:

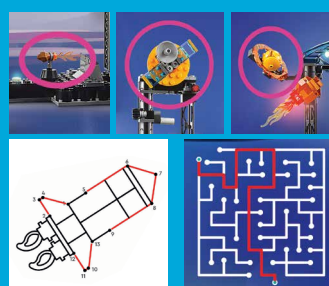

ANSWERS:

LEGO® Super Mario™, p. 6:



LEGO Technic™, p. 11:

TRY THESE ROUTES TO MAKE IT TO THE FINISH LINE.



LEGO Harry Potter™, p. 17:



LEGO Marvel, p. 18:



LEGO Indiana Jones™, p. 19:

VENICE, PARIS, VIENNA, BERLIN

LEGO® Life
PO Box 1138
Enfield, CT 06082

Presorted Standard
U.S. Postage
PAID
LEGO Direct

Next issue of the LEGO® Life Magazine out in January!



BUILD A HEART, SHARE THE JOY

Build a heart and share it in the Build to Give group in the LEGO® Life app to help bring the superpower of play to children in need.



**STAY
TUNED FOR
THE NEXT
ISSUE**

See you in
2024!

