

DISCOVER
THE WORLD OF
YOUR WILDEST
DREAMS



THE **MAGAZINE**



DREAMZZZ



COOL CREATIONS

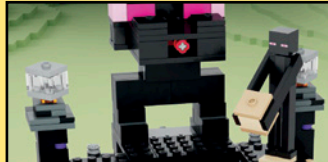

ACTIVITIES



COMICS



NEW LEGO MODELS

JUL - OCT | 2023



DO YOU WANT TO HEAR MY NEW SONG? NATURE MAKES ME SO HAPPY AND CREATIVE.

EATING TOGETHER IS MY FAVOURITE PART OF EVERY ADVENTURE!

IT SEEMS I'M NOT THE ONLY ONE WHO PREFERS NIGHT TO DAY?

I ALWAYS FORGET WHICH ONE IS WHICH, SO I MAKE UP MY OWN CONSTELLATIONS!

WELCOME TO ISSUE 3!

THE ADVENTURES OF MAX



JUST FOR YOU!



Check out all the excitement in this issue! You will also see Max holding up his flag where pages have been created just for you. Look for him throughout the magazine!

PUZZLED?

Look for these icons on activity pages. They will tell you if the activity is easy, hard, or somewhere in between. Try them all and see how you do! **If you get stuck, the answers can be found on page 27.**





Check out this cool stuff inside!

New comics
Pages 4 & 8

Amazing challenges
Pages 6, 17, 19

Get inspired
Pages 12, 24, 26

And much, much more!

DON'T HAVE THE LEGO LIFE APP YET?

Ask a parent or guardian to download it today for **FREE** from one of the app stores and sign in with your LEGO Account.

Apple and the Apple logo are trademarks of Apple Inc., registered in the U.S. and other countries and regions. App Store is a service mark of Apple Inc. Google Play and the Google Play logo are trademarks of Google LLC.



TELL US WHAT YOU THINK OF THIS MAGAZINE!

Ask a parent or guardian to scan this code or visit LEGO.com/LIFESURVEY to take the survey right away!



LEGO Life Magazine

For information about LEGO Life visit LEGO.com/life

For questions about your membership visit LEGO.com/service

LEGO Life Magazine
PO Box 3384
Slough SL1 0BJ
00800 5346 5555

LEGO Life Australia
PO Box 856
North Ryde BC, NSW, 1670
Freecall 1800 823757

LEGO Life New Zealand
B:Hive, Smales Farm
Level 4
72 Taharoto Rd
Takapuna
Auckland 0622
New Zealand

(UK/AU/NZ)
LEGO, the LEGO logo, DREAMzz, the FRIENDS logo, the MINIFIGURES logo, NINJAGO, the Minifigure and the Brick and Knob configurations are trademarks of the LEGO Group. ©2023 The LEGO Group.



MAX'S NIGHT ADVENTURE

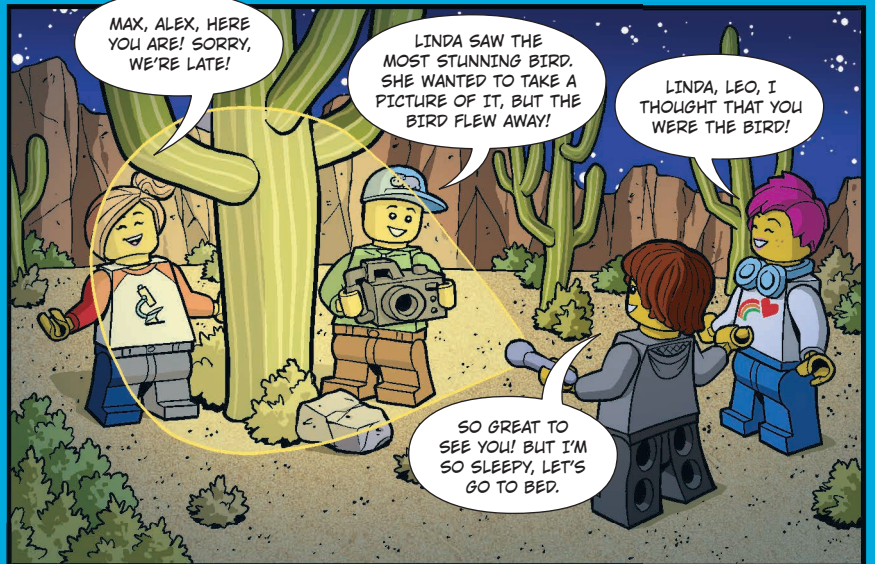
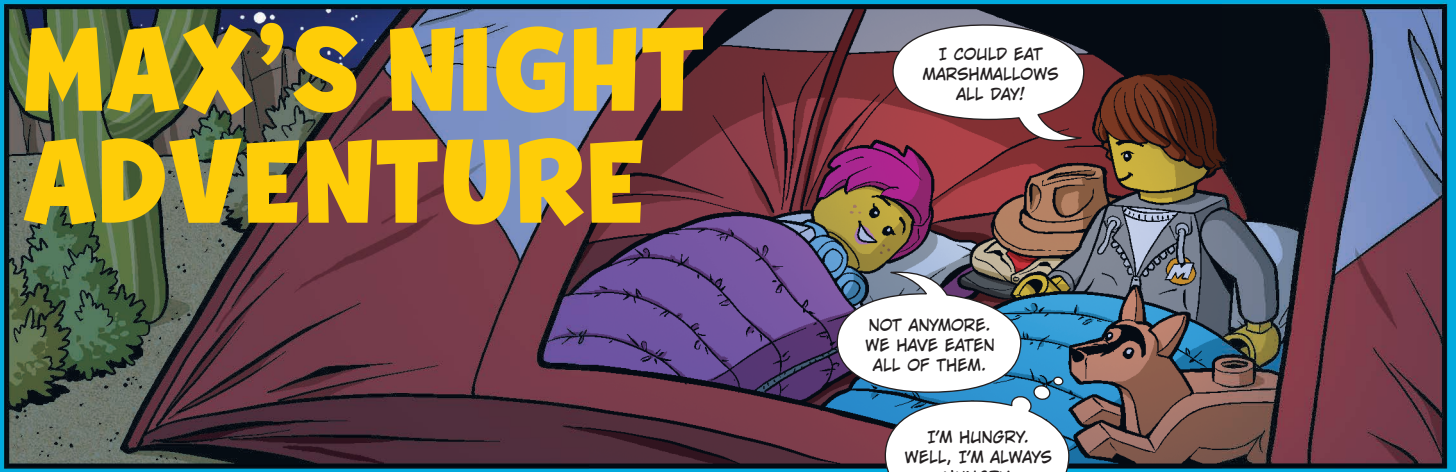



LEARN HOW TO DRAW MAX!



Grab a pencil and a piece of paper and follow these instructions. A rubber will come in handy, too.

STEP 1

Draw three squares. Use a pencil that can be easily erased with a rubber. The squares are there to help you with the drawing.

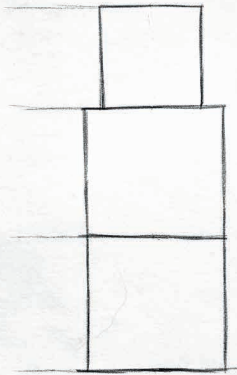

STEP 2

Add more lines to create the shape of Max. Don't forget to add the eyes and a smile!

Tip: You can use a different colour pencil now.

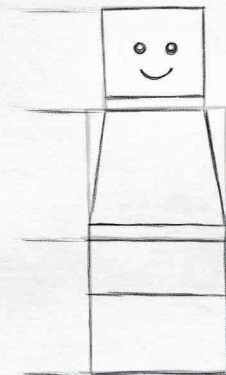

STEP 3

Round Max's head, add arms and other details. When done, you can erase the lines from Step 1. Finish off by adding a cool haircut and colour Max in!

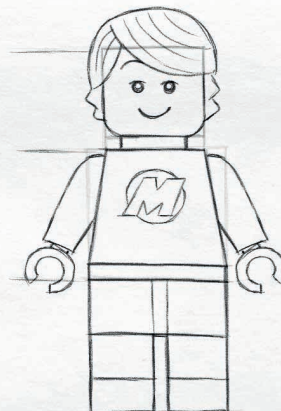

DISCOVER YOUR DRAGON ENERGY

Start your new NINJAGO® adventure. Follow the path of the ninjas to unlock your inner dragon energy.



HOW TO CREATE YOUR STORY?

- ◆ Move 1 tile at a time from START to the centre of the dragon.
- ◆ Make decisions. Select the arrows and decide where to go next.
- ◆ Overcome the challenges. Fulfil various tasks and mini-games, and defeat enemies on your way.

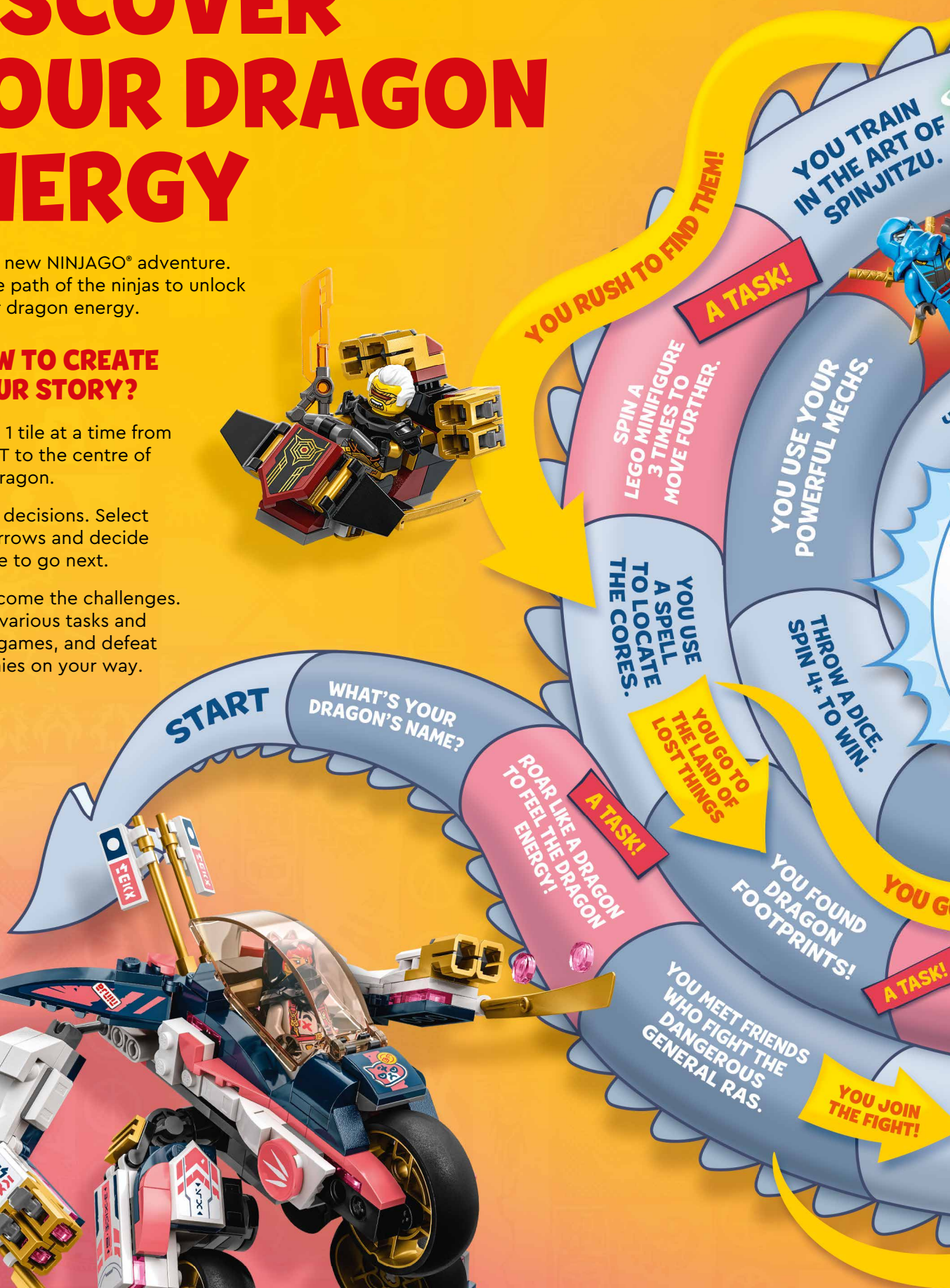
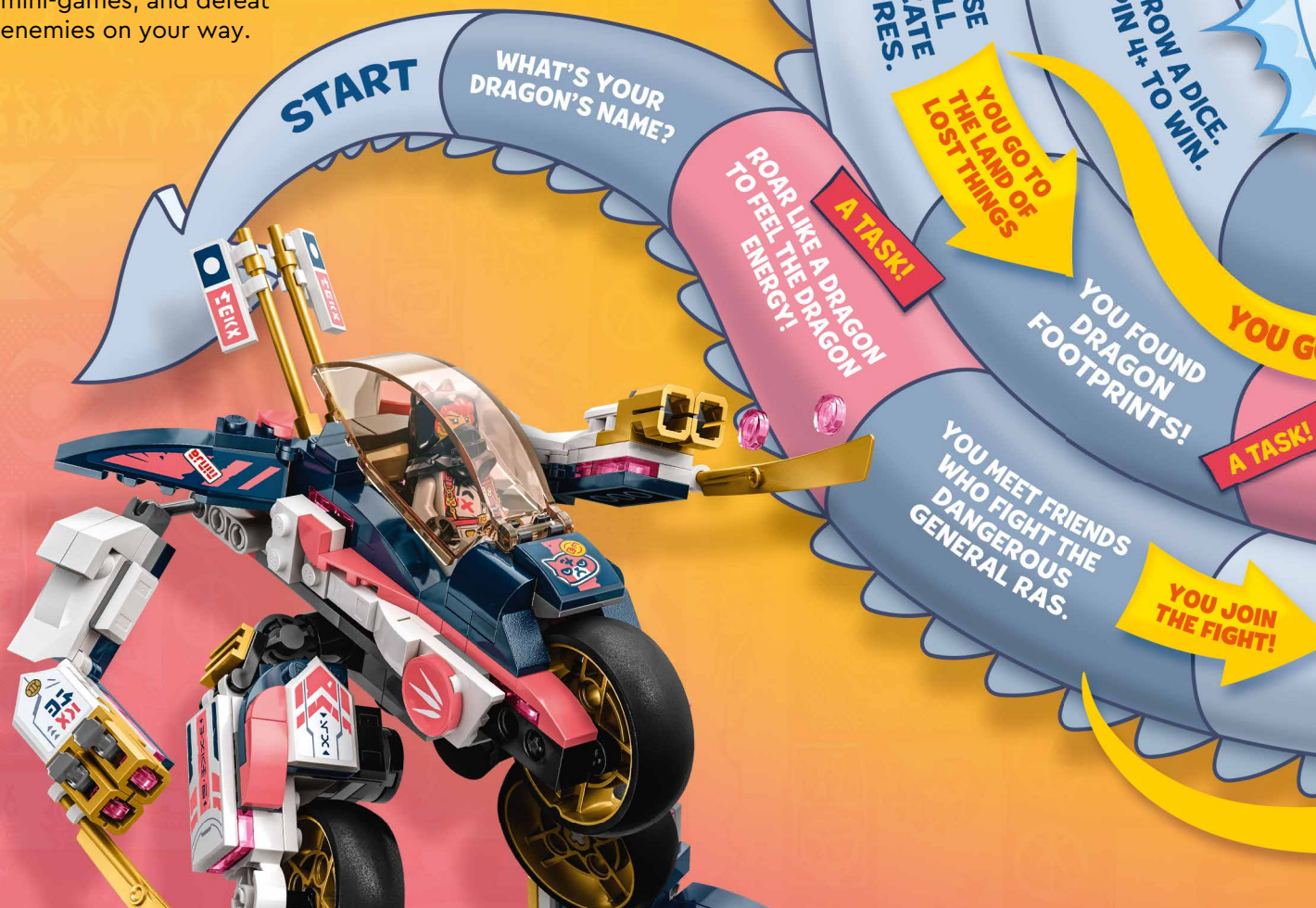



A TASK!
 BUILD YOUR OWN MONASTERY WITH YOUR LEGO® BRICKS.



HUNT FOR THE DREAM CREATURES



Mateo and his sister Izzie can travel through the lands of dreams. They try to catch the dream creatures and stop the Nightmare King from invading the waking world. They have found many wonderful beings... But some went missing!

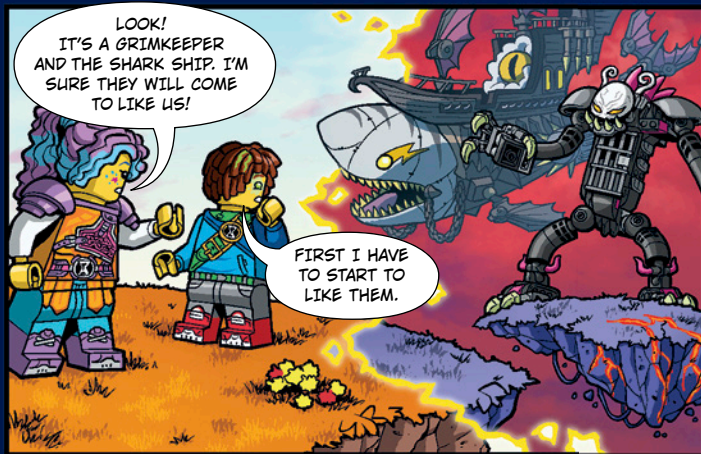

HELP IZZIE AND MATEO FIND THE DREAM CREATURES

Z-Blob, Zian and Señor Tortuga are hiding inside the LEGO® Life Magazine. Read the magazine and find where they are.

Need Help? Answers can be found on page 27.



Continue the hunt in the LEGO® DREAMZZZ® group in the LEGO Life app.



Z-BLOB

Mateo's sidekick. He can travel to the waking world.



ZIAN

Very loyal to his friends. Part cat, part owl.



SEÑOR TORTUGA

Living, breathing (and carrot-loving) food truck/pawn shop.

EXPLORING THE DEPTHS



Dive in the ocean with Ella, Steve and their friends. What will they find? Hop aboard the Arctic Explorer Ship and discover new things. **Can you see a shipwreck here?**

Still looking for a shipwreck? Check page 27 for the answers.



WHOA! THE SHIP IS A BIT ROCKY!

SO COOL TO SEE THEM THIS CLOSE.

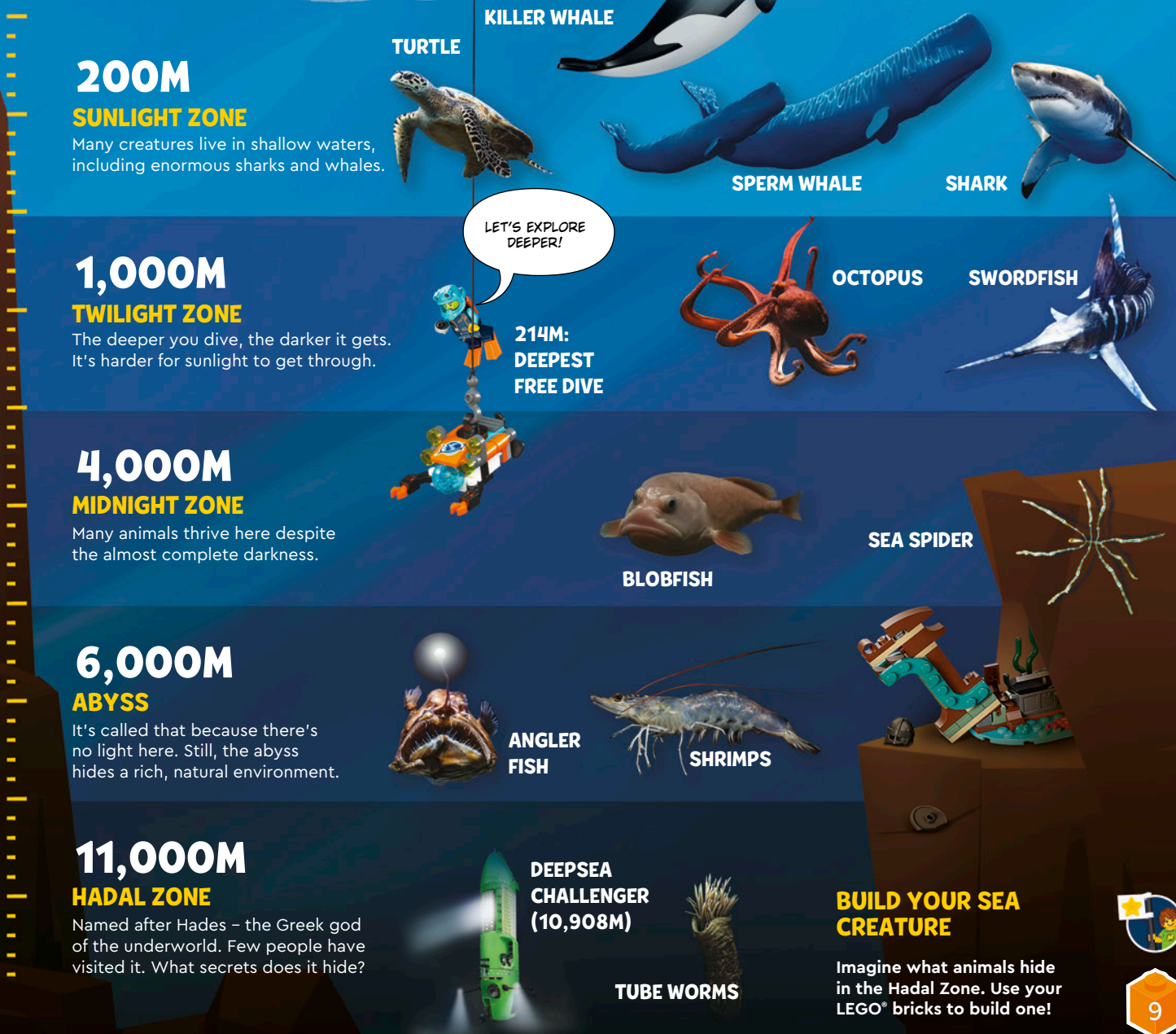

200M

SUNLIGHT ZONE

Many creatures live in shallow waters, including enormous sharks and whales.

TURTLE



KILLER WHALE



SPERM WHALE



SHARK



1,000M

TWILIGHT ZONE

The deeper you dive, the darker it gets. It's harder for sunlight to get through.

LET'S EXPLORE DEEPER!

214M: DEEPEST FREE DIVE

OCTOPUS



SWORDFISH



4,000M

MIDNIGHT ZONE

Many animals thrive here despite the almost complete darkness.

BLOBFISH



SEA SPIDER



6,000M

ABYSS

It's called that because there's no light here. Still, the abyss hides a rich, natural environment.

ANGLER FISH



SHRIMPS



11,000M

HADAL ZONE

Named after Hades – the Greek god of the underworld. Few people have visited it. What secrets does it hide?

DEEPEST CHALLENGER (10,908M)



TUBE WORMS



BUILD YOUR SEA CREATURE

Imagine what animals hide in the Hadal Zone. Use your LEGO® bricks to build one!



ADVENTURES AT THE AMUSEMENT PARK



AMUSEMENT PARKS ARE THE BEST!

I'M HUNGRY!
LET'S GO FIND
SOME FOOD.

ANYONE WANTS TO
RACE TO THE WAVE
MACHINE?

GREAT IDEA!

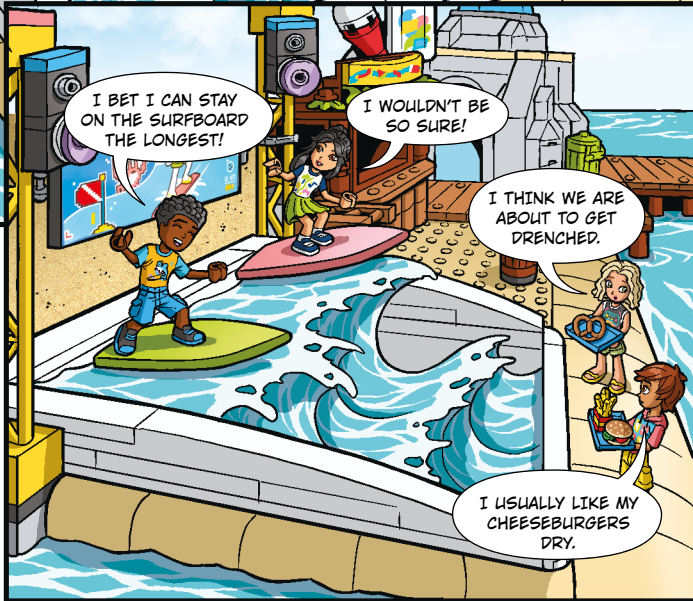

I BET I CAN STAY
ON THE SURFBOARD
THE LONGEST!

I WOULDN'T BE
SO SURE!

I THINK WE ARE
ABOUT TO GET
DRENCHED.

I USUALLY LIKE MY
CHEESEBURGERS
DRY.

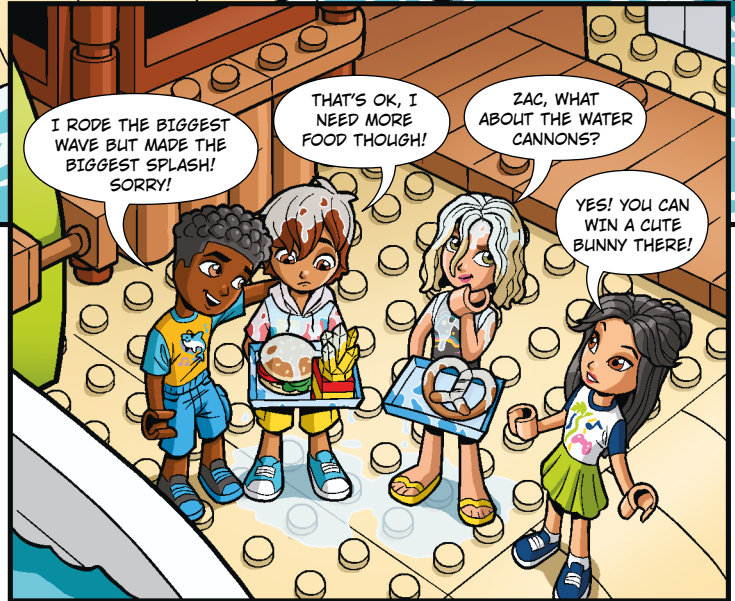

I RODE THE BIGGEST
WAVE BUT MADE THE
BIGGEST SPLASH!
SORRY!

THAT'S OK, I
NEED MORE
FOOD THOUGH!

ZAC, WHAT
ABOUT THE
WATER
CANNONS?

YES! YOU CAN
WIN A CUTE
BUNNY THERE!



I KNEW MY GAMING
SKILLS WOULD COME
IN HANDY!

OK!
WE ARE EVEN NOW.

AND WHAT ABOUT
MY BUNNY?



ZAC, THE BALLOONS
ARE FOR YOU. LIANN,
YOU TAKE THE BUNNY.

THANK YOU, NOVA!
NEXT STOP: THE SEA
LIFE CAROUSEL!

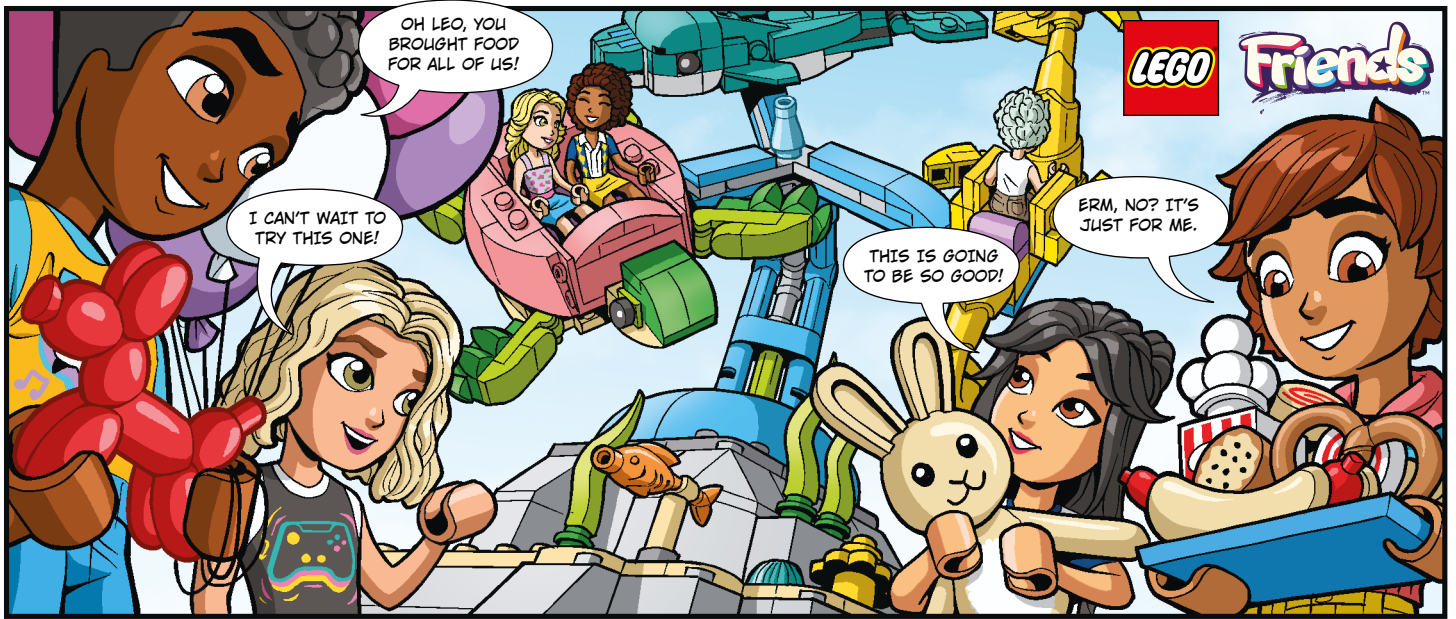

WHAT HAPPENED NEXT?

Read the last panel and draw the rest of the story.

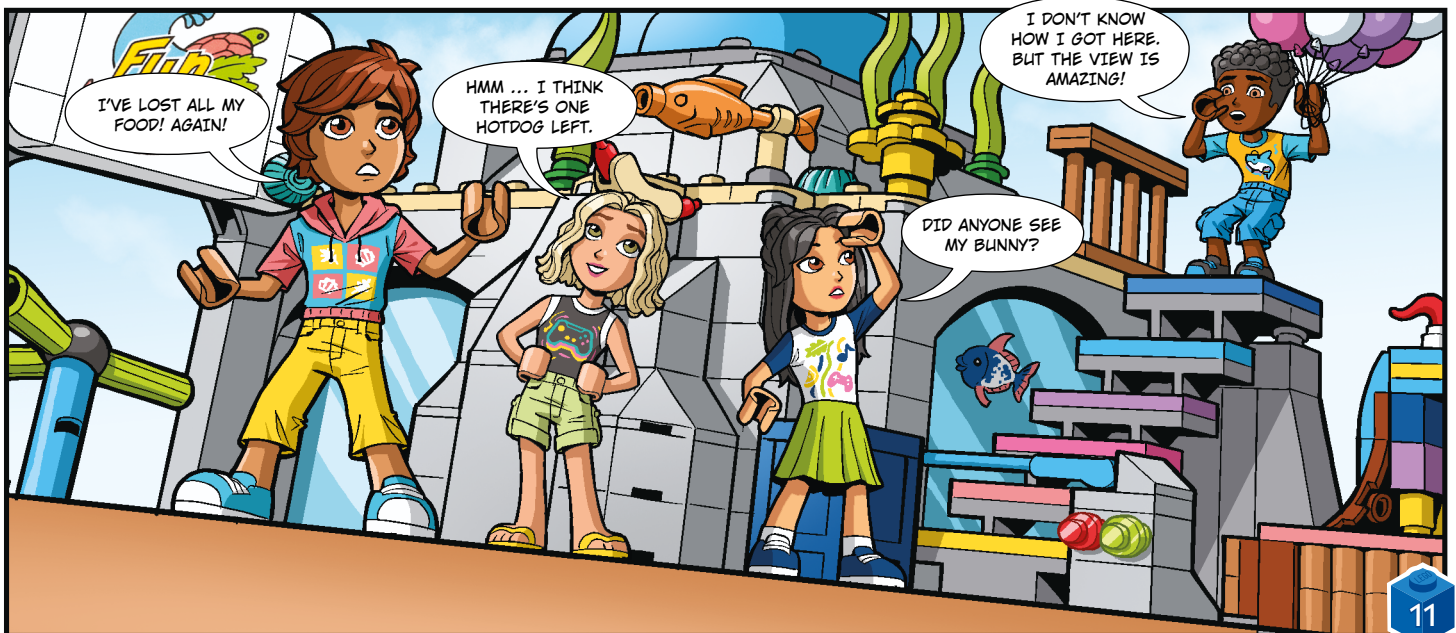

FIND YOUR PERFECT HOLIDAY SPOT

Imagine your perfect holiday. What would it look like? Would you spend your days enjoying exciting games with friends? Or wandering and watching animals in the wild? **Take the quiz and find the best place for you.**



What do you love to do on your holidays?

I love to relax and enjoy some peace and quiet.

I love to play and have fun with friends!

Do you prefer mountains or the sea?

Adventure in the city or outdoors?

Mountain views are incredible!

I love to feel the sea breeze!

I love to feel like an explorer!

I love parks and playgrounds!

"I dream about..."

"If I were a minifigure, I would be..."



"In the evening, I would like to..."

Walking through fields and forests.

Sailing all day!

Watch the animals and the sunset.

Watch my favourite shows.

Max  Linda or Leo  Alex 

Cosy House

Lake House

Canal House



DREAMZZ







NINJAGO

DRAGONS RISING





A BRIDGE OVER THE LAVA

Show your Minecraft® skills and survive in The End Arena. But first, you have to reach it! Will the enderman help you? Or will he get in the way?

FINISH THE BRIDGE

Match the right LEGO® bricks with the empty space in the bridge. Write the number of the brick. You can also colour it!

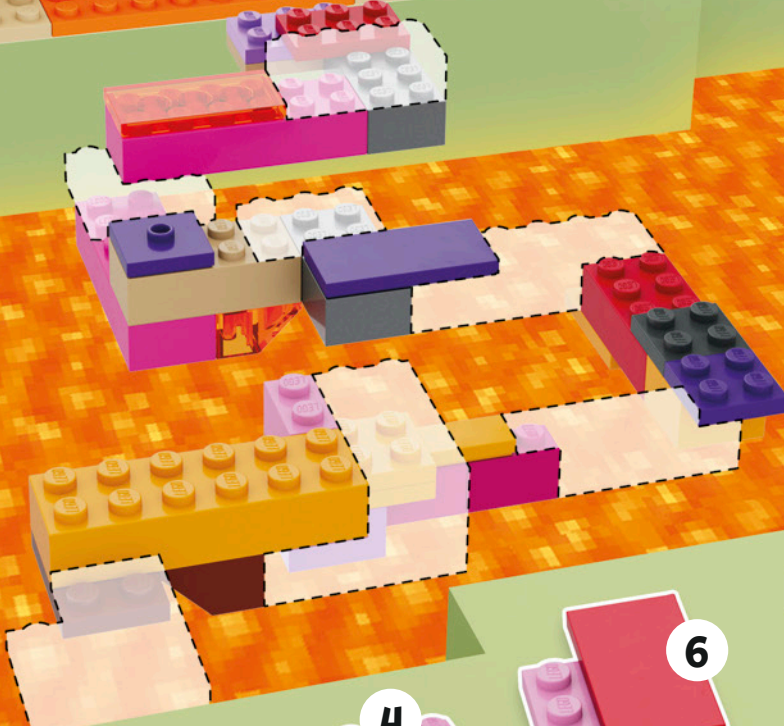
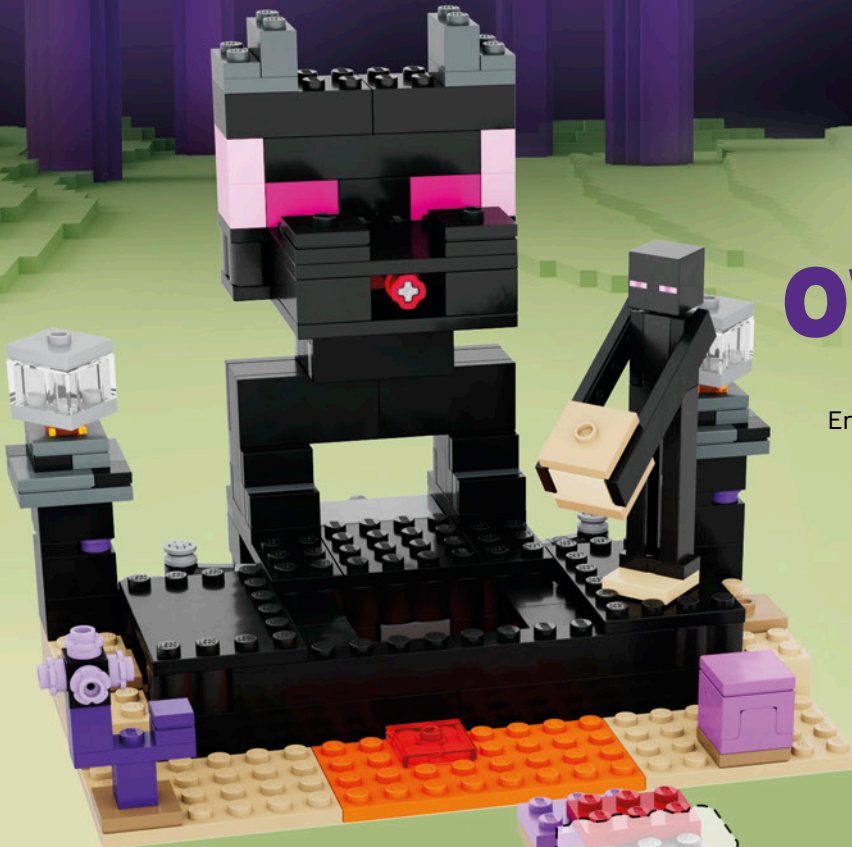

Do you need some help?
Check page 27 for the answers.

DRIVING MADE AWESOME

LEGO 2K DRIVE

ADVERTISEMENT

Visit the world of LEGO® 2K Drive and start the fun! Play co-op or online with your friends and family, and get a special reward car for the LEGO Life Magazine readers.



Where will the road take you?

Explore the massive open world of Bricklandia. Race anywhere, play together, and defeat a cast of wacky racing rivals.

Create a dream car

Free your imagination and build spectacular vehicles! Do you need speed? Power? Four-wheel drive?



Race, jump, drift

Do spectacular stunts! Have fun and show off your skills.

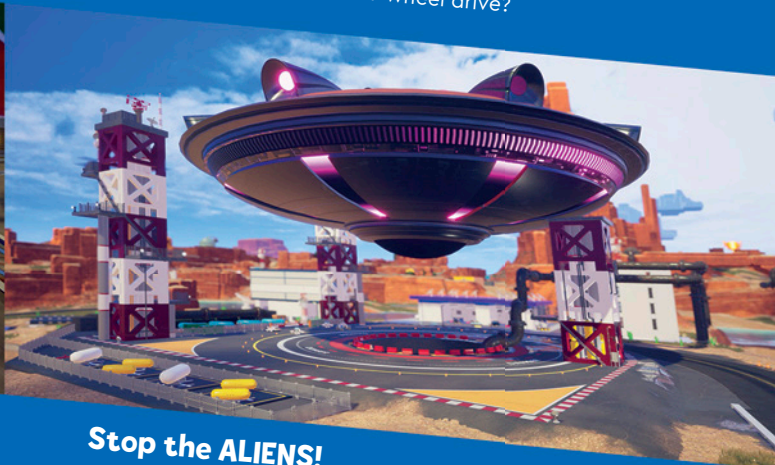

Stop the ALIENS!

They came from outer space in their UFOs. And they make a mess in Bricklandia! Can you thwart their plans?

LOOK FOR MORE IN THE AWESOME NEWS NETWORK

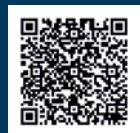

New rigs, blue pigs, amazing events and fresh features. Learn all about them from your best source of Bricklandia news. Don't forget to ask a grown-up's permission to scan the QR code.

WHAT WILL HAPPEN IF A ROBOT ZOMBIE EATS A MONSTER TRUCK? FIND OUT ON ANN!



CLAIM YOUR REWARD CAR*

Use this code in-game and unlock a unique vehicle!

AFVJY5OK



* LEGO® 2K Drive required. One per 2K account. Code expires: 19 May 2028. Void where prohibited. Terms apply. To redeem codes, visit Unkie's Emporium in LEGO 2K Drive, then go to the "Store" or "Official" tab and select "Redeem Code" at the bottom of the screen. Once you enter your code and get the message "Code Redeemed Successfully", your vehicle will now appear in your loadout! LEGO 2K Drive includes optional in-game purchases.



A SECRET MESSAGE TO CAPTAIN AMERICA



Captain America received a letter. But look, some words are missing! Help him unlock them. Use the symbols below to solve the riddle.

A	B	C	D	E	
F	G	H	I	J	
K	L	M	N	O	
P	Q	R	S	T	
U	V	W	X	Y	Z

MEET THE LEADER OF THE AVENGERS

Captain America's real name is Steve Rogers. He is one of the world's mightiest heroes. The Captain carries a one-of-a-kind vibranium shield that can defend him from almost any attack.



HAPPY BIRTHDAY, CAPTAIN!

We are throwing a party for you. Crack the code to see the guest list.

PEEKING AT THE DINOSAURS!



John Hammond, Dr Ellie Sattler and Dr Alan Grant are searching for the dinosaurs in Jurassic Park. Eventually, they will have a chance to admire different kinds of these fantastic creatures. But first, they need to find a Brachiosaurus.



Look at the images and give them a number, from one to four to put the story in the correct order. We've already marked the final picture for you!



Need Help? Answers can be found on page 27.

DID YOU KNOW THAT...

Brachiosaures were around 21 metres long and weighed up to 56 tonnes. That's more than nine African elephants! Brachiosaurus' upper arm bone was over 1.8 metres long, so taller than most humans.



20



A VISIT TO MARS



Mars is one of eight planets of the solar system. You can explore it using LEGO® Technic NASA Mars Rover Perseverance features and the AR app. Take control, go on a mission, and learn more about the Red Planet!

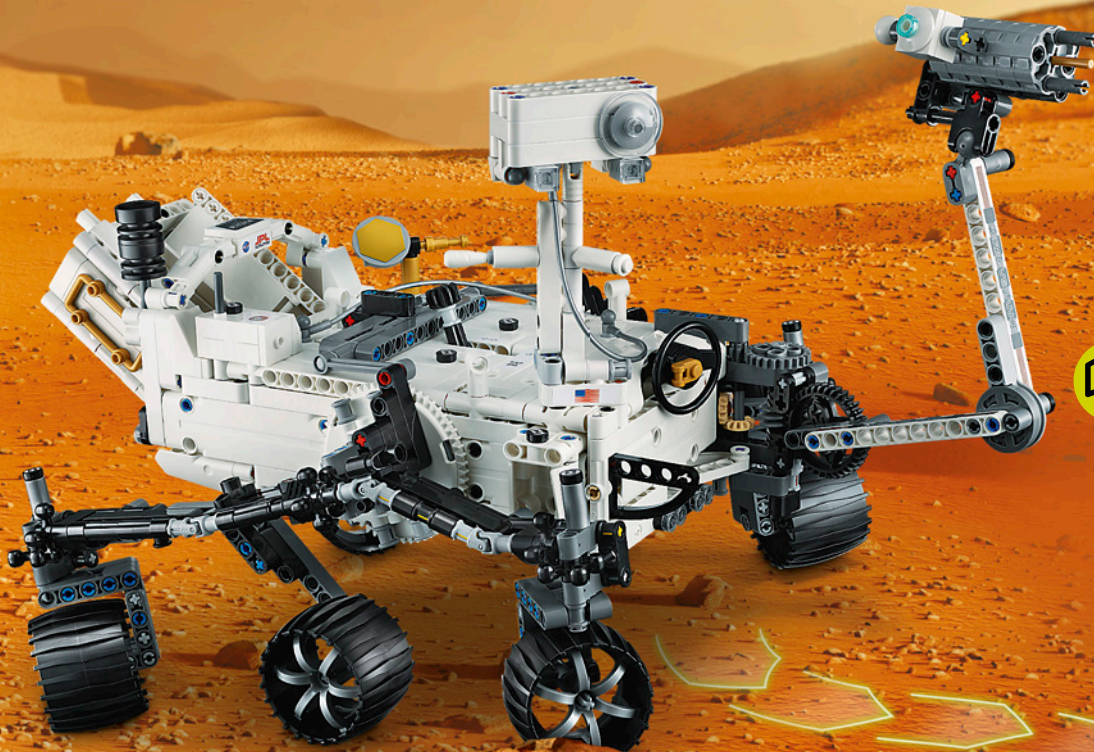

360° STEERING

Explore using steering and fully articulated suspension.



ROBOTIC ARM

You can move the robotic arm to explore new places.



ENVIRONMENT MODE WITH AR APP

Use the app to move the helicopter. Study the atmosphere of Mars and search for the ancient river valleys.

NASA Insignia and identifiers provided and used with permission of NASA.

Patent No. D673,482. JPL logo provided and used with permission of the California Institute of Technology.



CHECK YOUR KNOWLEDGE

How much do you know about our solar system? Look for clues on this page.

1. WHAT IS THE NICKNAME OF MARS?

- Yellow Planet Red Planet Green Planet

2. HOW MANY PLANETS ARE THERE IN OUR SOLAR SYSTEM?

- 9 10 8

3. WHAT WOULD YOU USE TO STUDY ROCKS ON MARS?

- The Mars Rover's robotic arm A telescope A stick!



FIND OUT MORE!

Explore the Technic group in the LEGO® Life app. Don't forget to ask a grown-up's permission before downloading apps.



Not sure of the answers? Find them on page 27!

SPORTS, FUN AND MAGIC!

Discover the wizards' beloved broomstick-wielding sport: Quidditch™. It's time to take a broom in your hands. Score more goals, catch the Golden Snitch™, and become the next Quidditch champion! But beware – many magical, unexpected things can happen during the game.



THE RULES

Players fly on brooms and get 10 points for throwing a ball (called a Quaffle) through the hoops.

WHERE IS THE REFEREE?

One time, halfway through a game, a referee disappeared! Someone turned his broomstick into a Portkey. The referee found himself stuck in the Sahara Desert!



THE LONGEST GAME

The Quidditch game can end in minutes. But it can last for hours, days ... or even months. The longest game lasted 3 months! The players needed to be substituted so they could eat and sleep.



THE QUIDDITCH™ TEAMS OF HOGWARTS™

The Quidditch teams are the pride of each Hogwarts™ House. They play to win the Quidditch Cup, while students from their House cheer them. After finishing school, the best players can join professional teams!





JOIN THE GAME!

Select your team and start a Quidditch™ game! Play with your friends and family. The rules are simple:

1. Take a marker pen (each player needs a different colour).
2. The youngest player goes first.
3. Players take turns. On your turn, close your eyes and hover the marker pen above the hoops.
4. Drop the marker pen without opening your eyes.
5. After five rounds, count the dots inside the hoops. Whoever scored more points, wins!
6. In case of a draw, play until one player wins.



NO DRAGONS ALLOWED!

One of the rules states "no dragon is to be introduced into the stadium for any purpose including, but not limited to, team mascot, coach, or cup warmer." Imagine what a dragon coach would look like!

HARRY VS DRACO

They faced each other on multiple occasions, Quidditch games included. They were both Seekers, trying to catch the Golden Snitch. And Harry won every duel!



COOL CREATIONS

Lola's Jungle Paradise
Lola, age 9, Canada



The Devastator and Sub
Jake, age 6, United Kingdom



Alien Village
Celine, age 9, Australia



Do you have an **AWESOME BUILD** you would like to share with other builders?

SEND US YOUR PHOTO!

- 1 Have a photo taken of you with your build. You might see it on this page in a future issue.
- 2 Ask a parent or guardian to go to [LEGO.com/cool-creations](https://www.lego.com/cool-creations).
- 3 There they can download and complete the Submission Form, then email it along with your photo. See the Submission Form for the email address.
- 4 Remember that you can send us a story about your model too. Tell us how you built it, what's going on in the scene, or whatever you like. Max also loves getting your letters!

Pirate Ship
Nathan, age 5, Australia

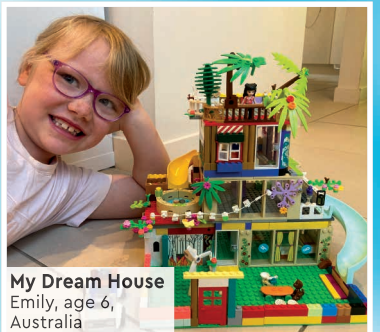

My Dream House
Emily, age 6, Australia

THANKS TO EVERYONE WHO SENT IN THEIR CREATIONS, INCLUDING REYANSH, HANNAH, WILLIAM, EVIE, LUIS, MALTE AND YOUCHIN.

EVERY BUILD YOU SENT MADE US SAY "WOW!".

THEY LOOK LIKE THEY ARE FROM A DREAM!



The Fantastic Alien's Nature Castle
Fionn & James, age 6, Ireland



Amusement Park
Louis, age 9, Germany



Rainbow Dragon
Alessandro, age 8, Germany



Giulia's Cool Creation
Giulia, age 5, Belgium



Superhero Town
Kai, age 5, USA



Round the World Trip
Tom, age 7, France



Potion House
Serena, age 5, Canada

World Cup Stadium
Teun, age 8, The Netherlands



Titanic
Marcello, age 6, The Netherlands



Happy Valley
Alana, age 8, UK



The Holiday Village
Judith, age 7, France



Technic Land Rover
Skyla, age 10, United Kingdom



The Mega City
Erika, age 7, Ireland



K-Pawp City
Jasmine, age 8, New Zealand

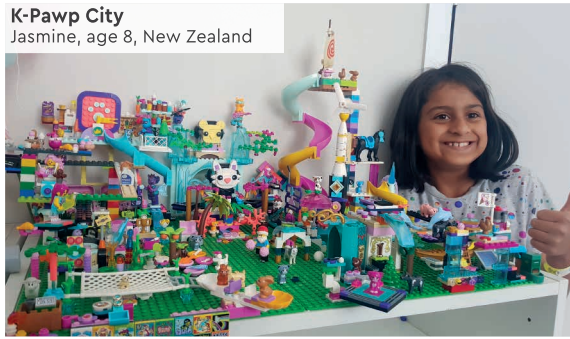

Elin's Evil City
Elin, age 7, Denmark



**Rebuild
the
world**

IT'S TIME TO START A JOURNEY!

Build together

LEGO CLASSIC



Invite friends to build a hot air balloon. Use any LEGO® bricks you have. They can have different colours or shapes, whatever you have in your collection! Once you finish, what will you create next? A colourful bird? A dragon? Or something from your wildest dreams? Whatever you build, we'd love you to share your creations with us. (See page 24 for details).



You can also share your LEGO® creation in the LEGO Life app Magazine Stuff group.

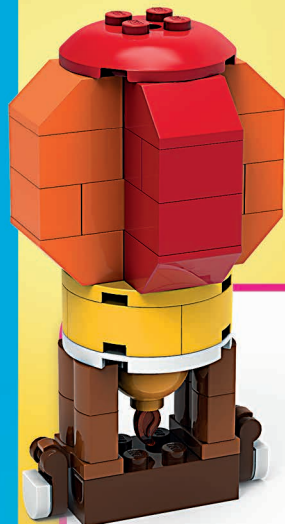

1



2

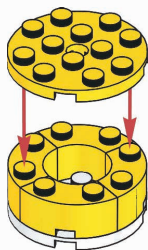

3

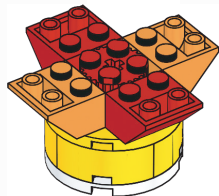

4

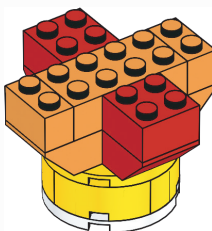

5

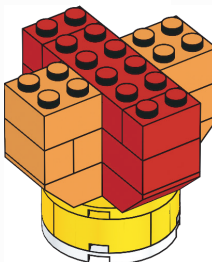

6

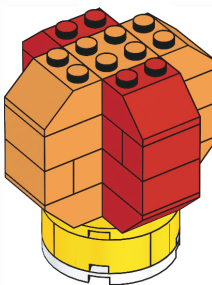

7

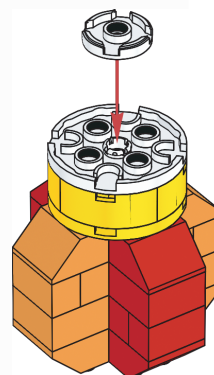

8

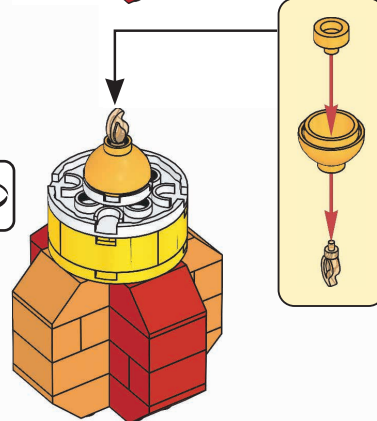

ANSWERS

LEGO® DREAMZZ™, p. 8:



LEGO City, p. 9:



LEGO Minecraft®, p. 17:

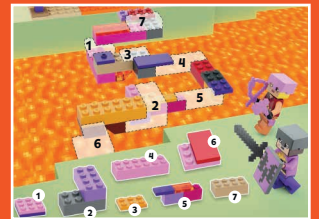

LEGO Marvel Super Heroes, p. 19:
HULK, THOR, SPIDER-MAN

LEGO Jurassic World, p. 20:



LEGO Technic, p. 21:

1. Red Planet, 2. 8,
3. Mars Rover's robotic arm

9

1

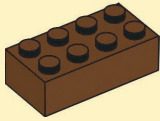

2

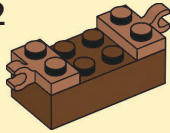

3

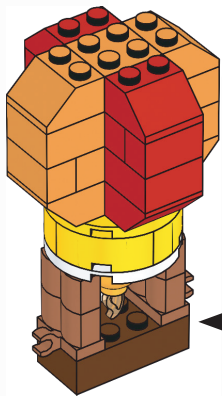
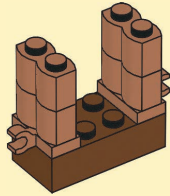

10

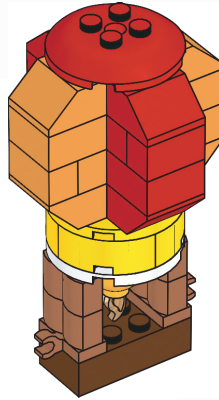

11

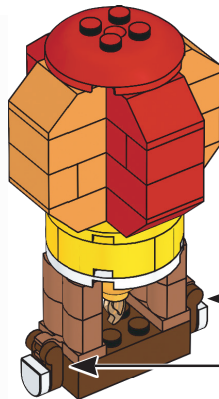
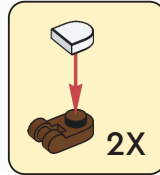

Get the free
LEGO® Builder app and
start building with
digital instructions!



- Save your sets
- Zoom in
- Rotate your model while you build
- Track your building completion!

Don't forget to ask a grown-up's permission before downloading apps.



Next issue of the LEGO® Life Magazine out in November!

HUNT FOR THE DREAM CREATURES

LEGO DREAMZZZ

Some of the dream creatures have gone missing! They escaped the dream world and are now hiding. Can you help Mateo, Izzie, Zoey and Cooper find them?

CHECK THE ACTIVITY ON PAGE 8

Z-Blob, Zian and Señor Tortuga are hiding inside the magazine. Can you find them?

CONTINUE THE HUNT AND STREAM THE NEW SERIES ON [LEGO.com/kids](https://www.lego.com/kids).

HEY, WHERE'S Z-BLOB?

LET ME GUESS. IF YOU CAN'T SEE HIM, IT MEANS HE'S GONE.

WE'LL FIND THEM!

GREAT! LET'S HUNT FOR THE DREAM CREATURES!

