

THE MAGAZINE



POSTERS



ACTIVITIES

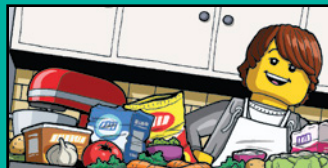

COMICS



COOL CREATIONS

WELCOME TO ISSUE 1!

**XĪNNIÁN
KUÀILÈ!**
IT MEANS
"HAPPY NEW YEAR"
IN MANDARIN.

THESE LANTERNS
WE'RE MAKING
WILL
LOOK GREAT FOR THE
LANTERN FESTIVAL.

CLEANING CAN BE
FUN ... RIGHT?

LET'S CELEBRATE
THE CHINESE YEAR
OF THE RABBIT WITH
SOME CARROTS!

THE ADVENTURES OF MAX RABBIT

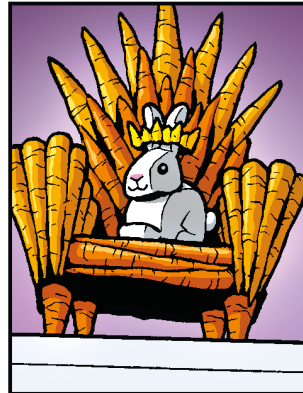
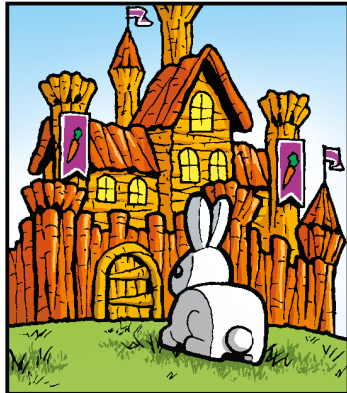
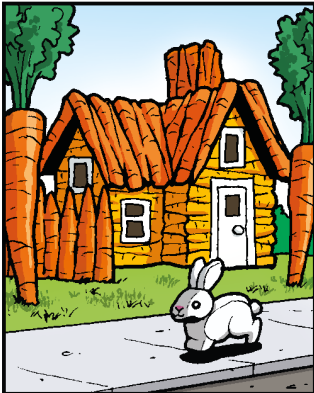

JUST FOR YOU!



Check out all the excitement in this issue! You will also see Max holding up his flag where pages have been created just for you. Look for him throughout the magazine!

PUZZLED?

Look for these icons on activity pages. They will tell you if the activity is easy, hard, or somewhere in between. Try them all and see how you do! **If you get stuck, the answers can be found on page 27.**





DON'T HAVE THE LEGO® LIFE APP YET?

Ask a parent or guardian to download it today for **FREE** from one of the app stores and sign in with your LEGO® Account.

Apple and the Apple logo are trademarks of Apple Inc., registered in the U.S. and other countries and regions. App Store is a service mark of Apple Inc. Google Play and the Google Play logo are trademarks of Google LLC.

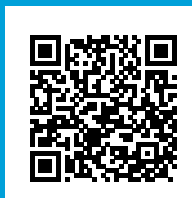

Hi, I'm Captain Safety!



Want to know more about how you can stay safe online? Look for me in the LEGO® Life app for tips on what you and your parents can do to make sure time online is fun and safe for everyone.

TELL US WHAT YOU THINK OF THIS MAGAZINE!

Ask a parent or guardian to **scan this code** or visit **LEGO.com/LIFESURVEY** to take the survey right away!

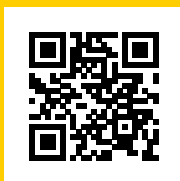

LEGO® Life Magazine

For information about LEGO® Life visit **LEGO.com/life**
For questions about your membership visit **LEGO.com/service**
or call **1-877-518-5346**

 PO Box 1138
Enfield, CT 06082

 PO Box 600
Markham, ON
L3R 8G8



(US/CA)
LEGO, the LEGO logo, the Minifigure, the Brick and Knob configurations, NINJAGO, the NINJAGO logo and the FRIENDS logo are trademarks and/or copyrights of the LEGO Group.
©2023 The LEGO Group. All rights reserved.

WHERE ARE MY CARROTS?

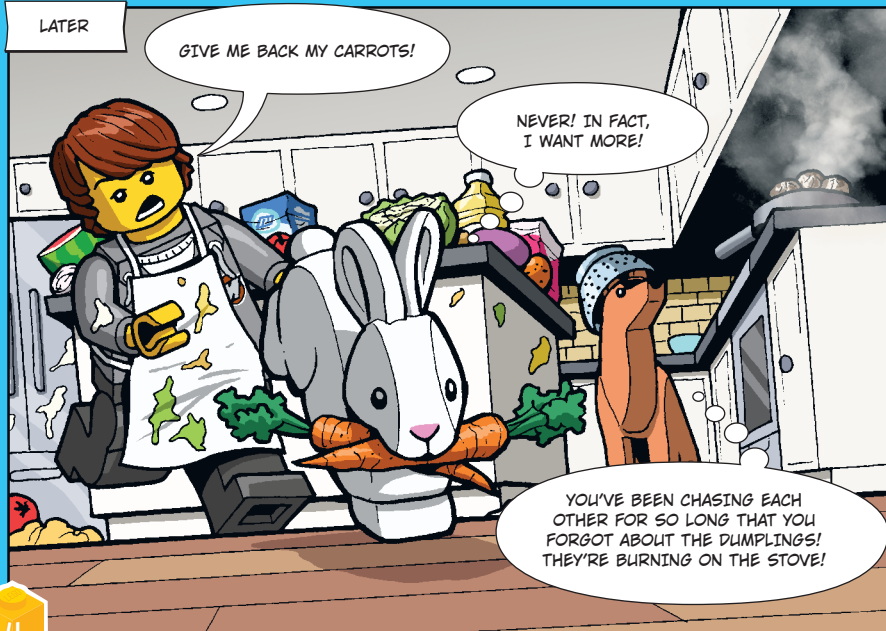



THERE'S NO TIME TO MAKE NEW DUMPLINGS! SHOULD I JUST ORDER A PIZZA?

PIZZA? I'LL HAVE A PIZZA!

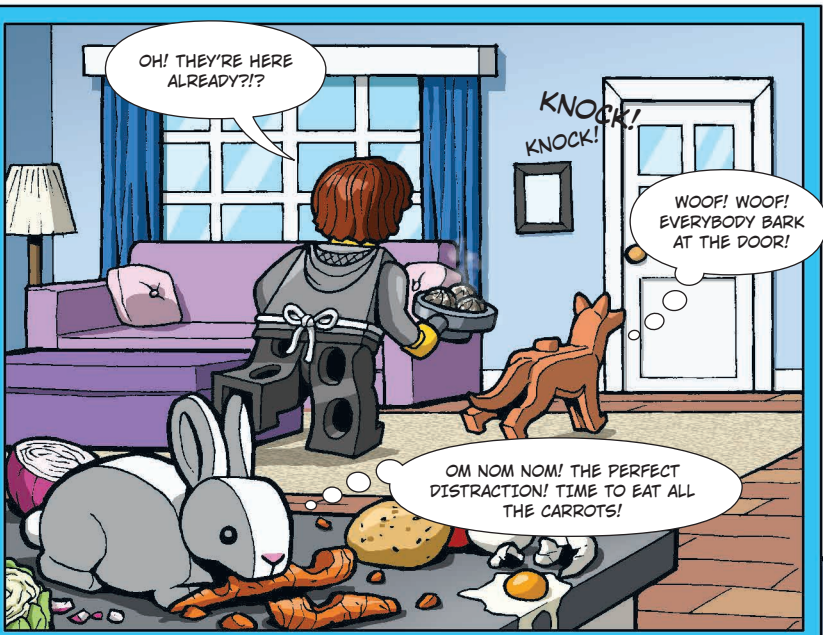

OH! THEY'RE HERE ALREADY?!

KNOCK!
KNOCK!

WOOF! WOOF!
EVERYBODY BARK AT THE DOOR!

OM NOM NOM! THE PERFECT DISTRACTION! TIME TO EAT ALL THE CARROTS!

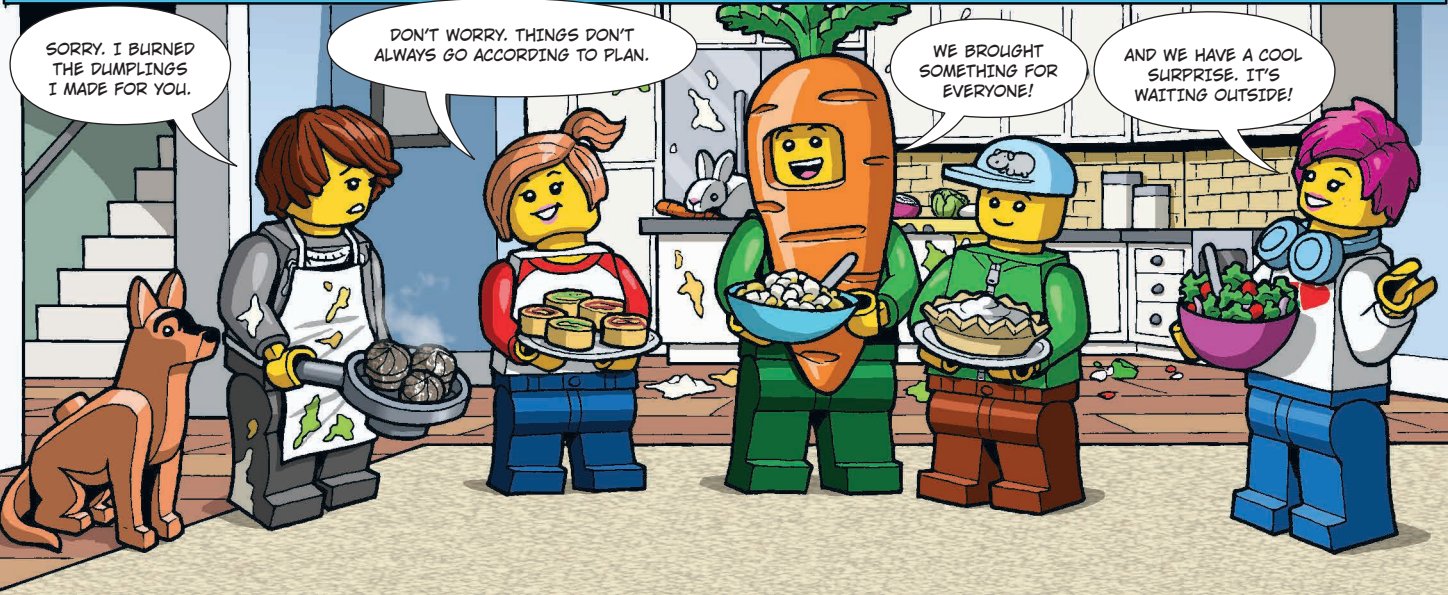

SORRY. I BURNED THE DUMPLINGS I MADE FOR YOU.

DON'T WORRY. THINGS DON'T ALWAYS GO ACCORDING TO PLAN.

WE BROUGHT SOMETHING FOR EVERYONE!

AND WE HAVE A COOL SURPRISE. IT'S WAITING OUTSIDE!

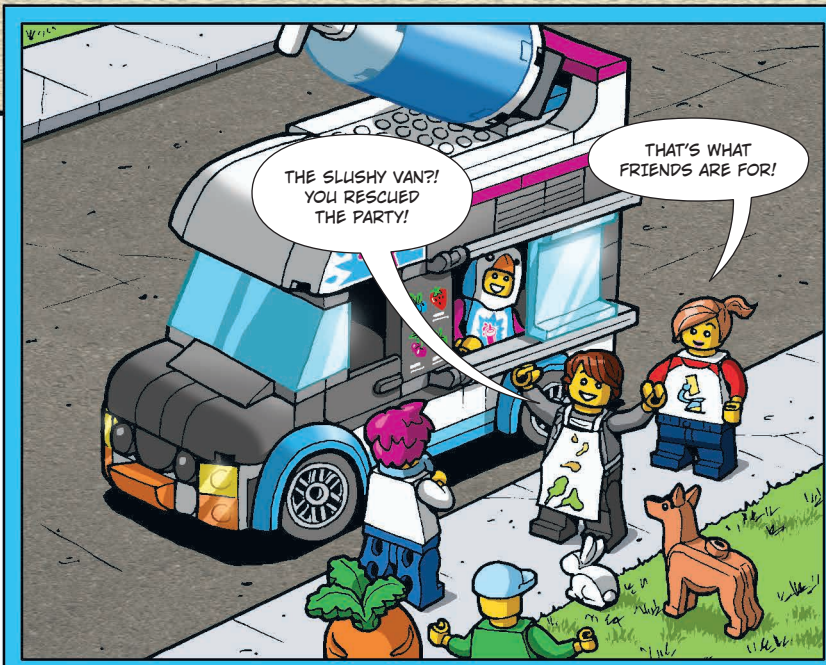

THE SLUSHY VAN?! YOU RESCUED THE PARTY!

THAT'S WHAT FRIENDS ARE FOR!



WE HEARD YOU HAD A RABBIT, SO WE EVEN BROUGHT CARROT SLUSHIES!

NO, THANK YOU! I ALREADY ATE TOO MANY CARROTS!

WHAT'S YOUR SUPERPOWER?

NEW!



MARVEL STUDIOS
THE INFINITY
SAGA

Each one of us has a superpower! Even if we don't always know about it. Which fantastic skill might be an ace up your sleeve? Are you as confident as Thor? Loyal as Captain America? Or maybe you have Black Widow's wits? Discover your superpower in our super quiz!

MY HAMMER AND I ARE INVINCIBLE!

FRIENDSHIP MAKES YOU EVEN MORE POWERFUL.

I'LL ESCAPE YOU ANYWAY BECAUSE I'M THE SMARTEST. MUAHAHAHAHA!



WHAT COULD BE YOUR SUPERPOWER?

Answer the questions and discover your super-talent.

1. IT'S THE MIDDLE OF THE NIGHT AND YOU HEAR SUSPICIOUS NOISES IN YOUR BEDROOM. YOU...

- A** Turn the light on and stand on your tiptoes to look taller.
- B** Throw LEGO® bricks on the floor, hoping the villain will step on them.
- C** You jump out of your bed to check if your parents are OK.

2. DO YOU LIKE GETTING UP EARLY?

- A** You are not afraid of anything, even the alarm clock set for 7:00 AM!
- B** Why would anyone wake up early and leave this cozy, warm bed?
- C** The earlier the better, more time for fun!

3. WHAT'S YOUR FAVORITE PLACE IN THE WORLD?

- A** A cave in the mountains that hides mysterious secrets.
- B** A playground in the park, where you can jump, swing, and climb.
- C** A yard where you can play with your friends... and win!

4. IF YOU WERE TO TURN INTO AN ANIMAL FOR ONE DAY, YOU WOULD LIKE TO BE:

- A** An eagle.
- B** A cougar.
- C** A bear.

NOW, COUNT THE ANSWERS.

You'll find out what superpower you have! Ask your friends which superpower suits you best if you have a draw.

MOST **A** ANSWERS

Some of the greatest of **Captain America's** virtues are his loyalty and bravery, and that he never gives up. Sounds familiar?



MOST **B** ANSWERS

Black Widow is skilled and fast... but also has a great sense of humor. Is that you? Your friends would agree!



MOST **C** ANSWERS

If you need someone solid and reliable, **Thor** is your go-to superhero. He also enjoys adventures, and just like you is always prepared to carry something heavy for the rest of the group!



THE GRANDFATHER'S NEXT INVENTION



The grandfather, a genius inventor, wants to introduce new attractions to his beloved amusement park. Help him decide. Choose one invention and follow the instructions.



★ INVENTION 1

A washing machine traveling in time.

If you enjoy time travel and the smell of clean laundry, this washing machine will make your head spin. Color all the bricks with stars.

■ INVENTION 2

A portal that guides you to exciting places.

Rides that go upside down? That's old news! Thanks to the magical portal you can go all around the world. Color all the bricks with squares.

▲ INVENTION 3

A little robot called Rusty displaying your happy dreams. If you love going to the cinema, this one is for you. Relax next to Rusty and return to your best dreams. Color all the bricks with triangles.

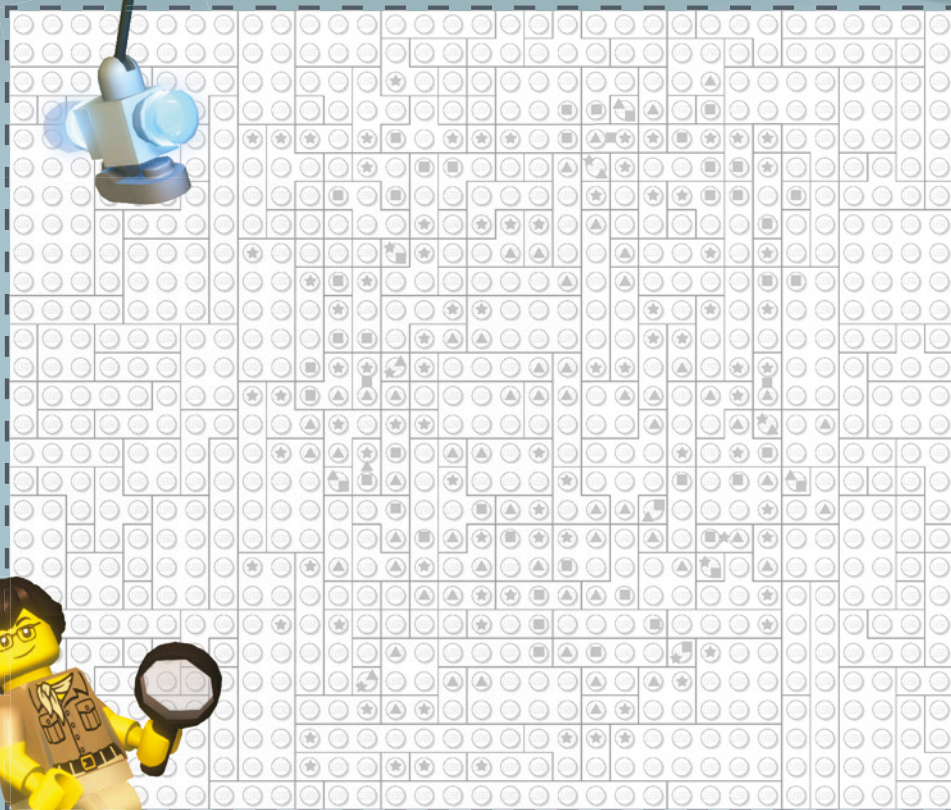

Look, this is how you can color the bricks.

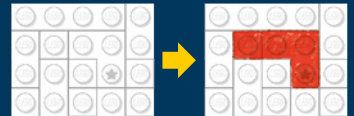

Do you need some help?
Go to page 27 and check the solutions.



GET THEM BACK HOME!

Many cute animals live in the LEGO® Minecraft® panda house and in the barn. But where have they gone now? Maybe the skeleton and the baby zombie scared them.



Help the jungle explorer, the rancher and the villager find the animals before the night falls. Follow the trails and check where they are hiding.

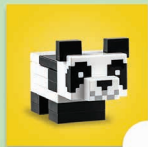
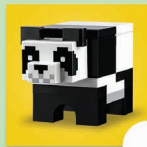
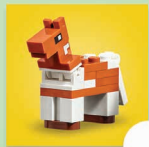
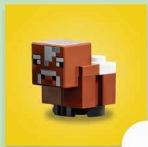
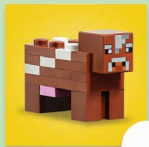



IF I WERE A COW,
WHERE WOULD I HIDE?

QUACK, QUACK,
CHICKEN ... NO ...
CLUCK, CLUCK...

PEEK-A-BOO, LITTLE
GOAT, WHERE ARE YOU?
DID YOU CLIMB A TREE?

Feeling lost?
Check the answers on page 27.

Where does your favorite animal live?

Build a house and send it to Cool Creations (see how on page 26).

Share your own animal house in the free LEGO® Life app!

Go to the Minecraft® group in the LEGO® Life app to share your building skills. Remember to ask your parent for permission.



THE COSMIC PUZZLE



IT WOULD BE GREAT TO HAVE A SCIENCE LESSON OUTSIDE TODAY!

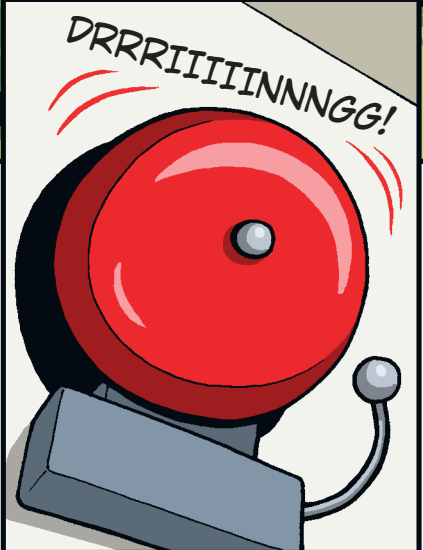

DRRRRIINNNGG!



I WISH WE COULD STAY HERE AND PLAY SOCCER.

WE CAN'T BE LATE!



SCIENCE CLASS

LOOK! WHAT IS IT? I THINK IT'S AN ALIEN EYE!

THIS IS WHAT ZAC IS SEEING...

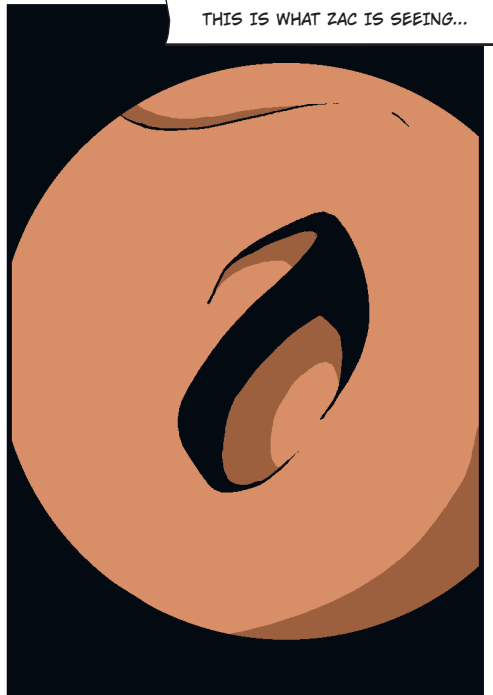



THAT CAN'T BE TRUE!

TIME FOR THE INTERGALACTIC SOCCER MATCH!

WE WILL BE FAMOUS!

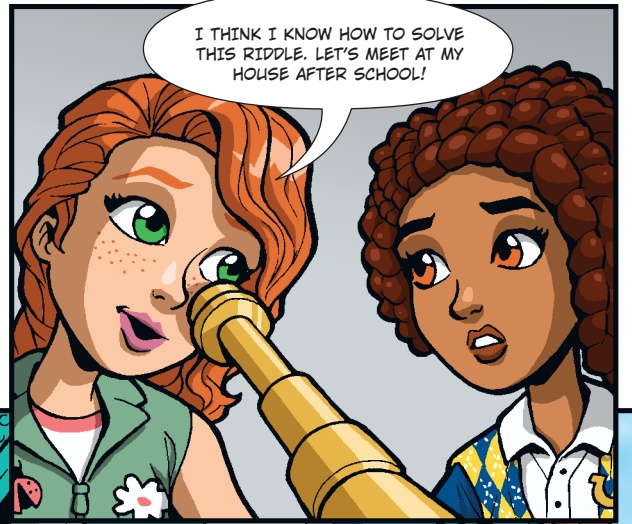

I THINK I KNOW HOW TO SOLVE THIS RIDDLE. LET'S MEET AT MY HOUSE AFTER SCHOOL!

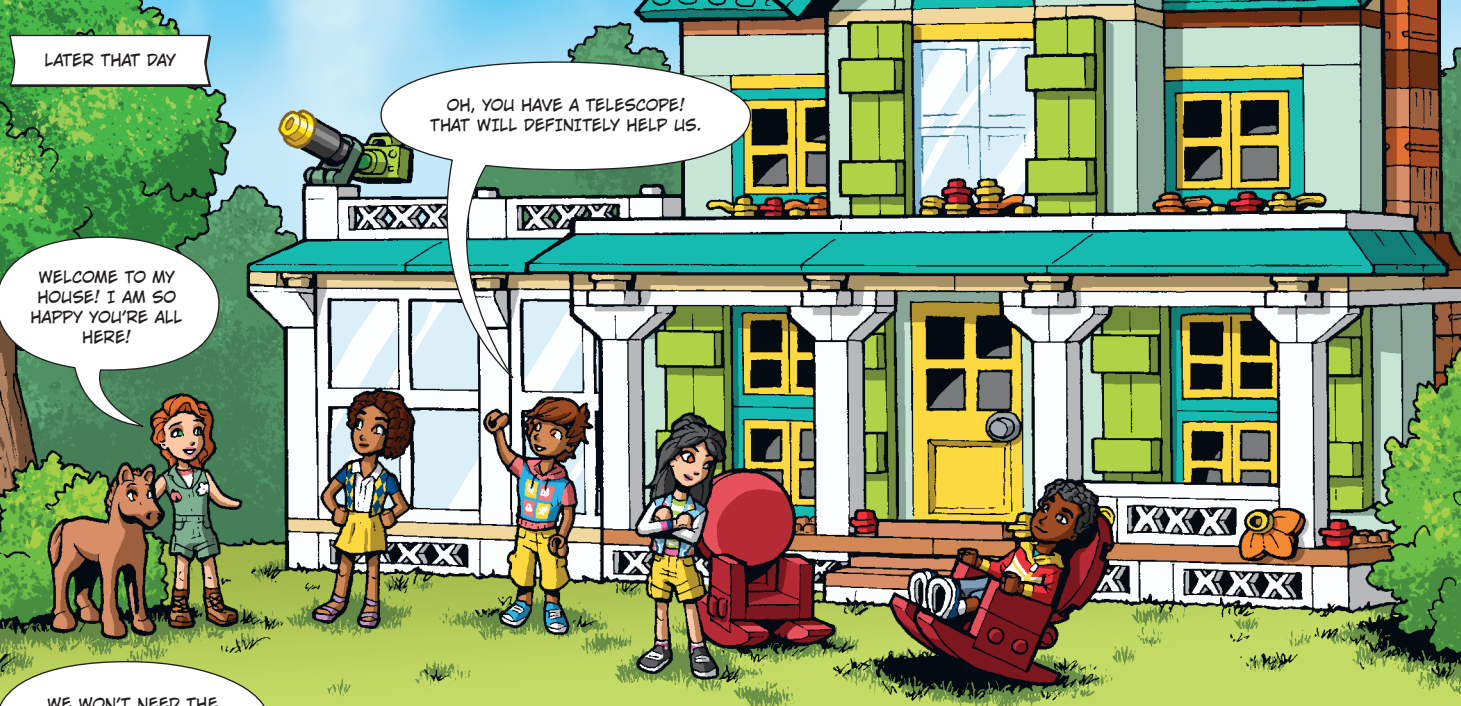

LATER THAT DAY

OH, YOU HAVE A TELESCOPE! THAT WILL DEFINITELY HELP US.

WELCOME TO MY HOUSE! I AM SO HAPPY YOU'RE ALL HERE!



WE WON'T NEED THE TELESCOPE, BUT THIS WILL COME IN HANDY.

OH! YOU HAVE A PICTURE OF THIS STRANGE THING WE SAW THROUGH THE TELESCOPE. BUT HOW?

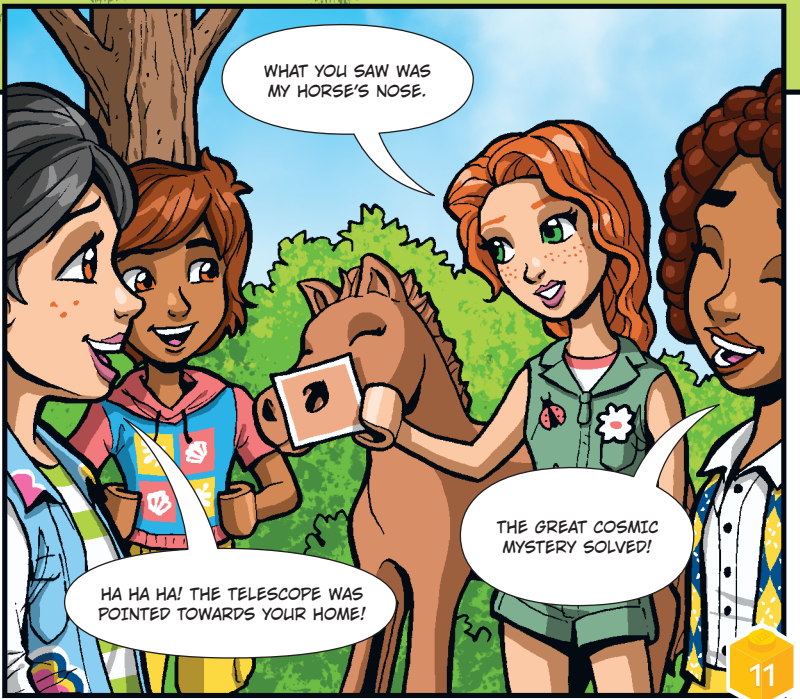

WHAT YOU SAW WAS MY HORSE'S NOSE.

HA HA HA! THE TELESCOPE WAS POINTED TOWARDS YOUR HOME!

THE GREAT COSMIC MYSTERY SOLVED!

LET'S MAKE FRIENDS

I WONDER IF THEY HAVE A RUNNING WHEEL CLASS.

SCHOOLS

WOW, WE ARE A SUPER TEAM!

I LIKE YOUR OUTFIT!

THANKS, I MADE IT MYSELF.

THAT WAS EASY!

LEO

OLLY

ALIYA

AUTUMN





SOMETIMES CODING IS EASIER THAN TALKING.

PAISLEY

YOU SHOULD TRY SINGING!

NOVA

AWESOME. DO IT AGAIN!

I COULD DO IT ALL DAY, DON'T WORRY.

ZAC

LIANN

CITY

LEGO

YOUR CITY
NO LIMITS





ANIMALS OF THE WORLD



A cockatoo, rabbit and a seal share the same color, but not a home. Each animal has their favorite environment. Seals prefer living on an iceberg or a pebbly beach. At the same time, rabbits enjoy hiding in the tall grass, and cockatoos prefer somewhere in the jungle. Choose one natural habitat from the photographs and draw it around each animal.

NEW!

A



MOUNTAIN FOREST

SAVANNA

JUNGLE

B



FOREST

MEADOW

WETLANDS

C



SEA

SEA ICE

PEBBLE BEACH



The three animals met at the beach for fun and games. Which animal left the footprints in the sand? Write the correct letter in the box.

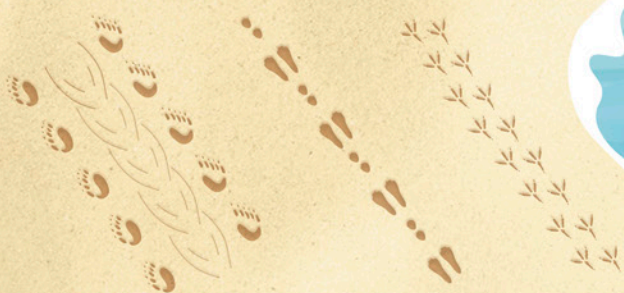

Need a little help? You can find the solution on page 27.



LET'S CELEBRATE FRIENDSHIP!

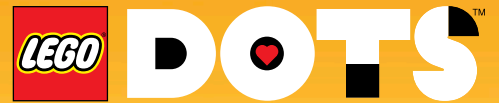

How about a cupcake party for your friend? Everything is almost ready. The only thing to do is to decorate the DOTS treats. Color in the cupcakes using your friend's favorite colors. You can even draw in extra shapes using LEGO® bricks or add stickers you may have at home.

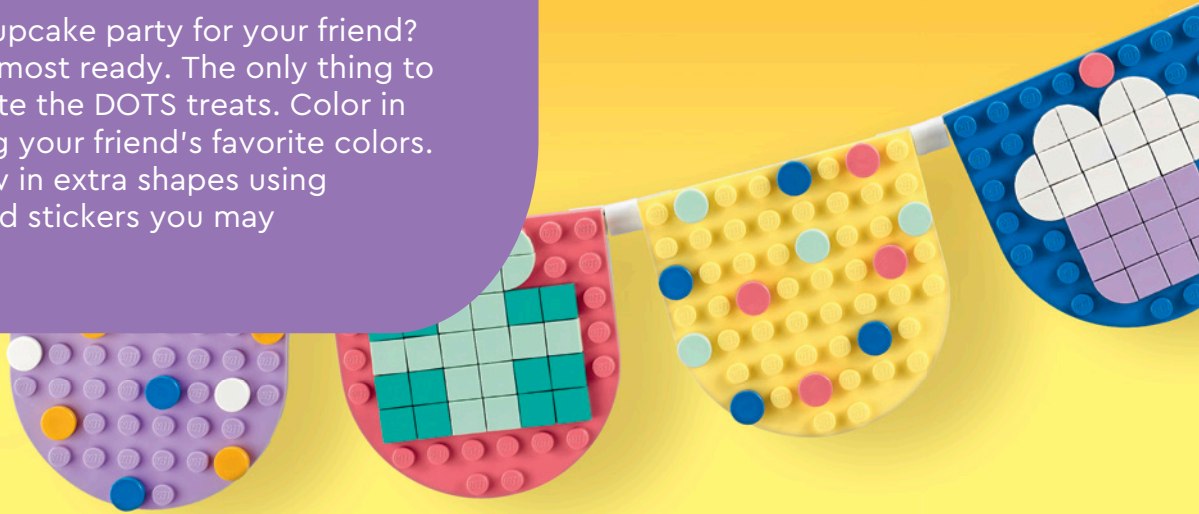

A BRACELET FOR YOUR FRIEND!

Show your best friend what they mean to you. Decorate friendship bracelets for both of you.

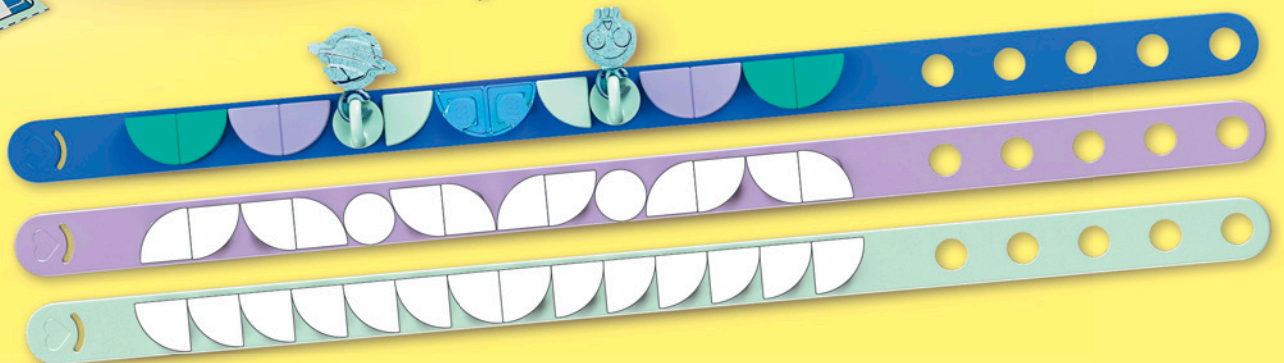



GET READY TO RACE!



Racing is one of the most awesome, amazing sports in the world! And certainly, the fastest. The LEGO® Technic™ Bugatti Bolide is a model of the newest and quickest car Bugatti designed. Check out these cool facts about this car.

SUPERB AERODYNAMICS

Multiple wings and flaps to generate the ultimate grip.

FAST AS A BULLET

Achieves more than 310 mph (500 km/h) – that's faster a than Formula 1™ car!

POWERFUL ENGINE

Monstrous 8-liter W16 engine with 1,850 horsepower.



ULTRA LIGHT

Only 2,734 lbs (1,240 kg) of weight – to be quickest at the start.

CHALLENGE YOUR FRIENDS TO A RACE!

How to play?

- Every player puts a LEGO brick on the START field. Those are the playing pieces.
- Put 10 more bricks in front of every player. This is your fuel.
- The youngest player goes first.
- In your turn, you can use 1 fuel to move 1 square.
- If you park on one of the special squares, you'll get fuel, lose fuel, move more squares (without using fuel!), or lose a turn.
- The first player to reach the FINISH line wins the race! If all players run out of fuel, the player who drove the furthest wins.



Explore more in the Technic™ group in the LEGO® Life app.

The Bugatti logo and Bugatti wordmark are trademarks of Bugatti International S.A. and are used under license. The CSR and CSR RACING logos are trademarks of Zynga Inc.

NOW, THIS IS AN ENTRANCE!

Max's friends arrived to make a show. Just look at them! Everyone came in a different and cool way. And they are doing stunts! But you can make their entrance more amazing!



I'VE NEVER SEEN ANYTHING LIKE IT!



YES, BUT DID THEY BRING CARROTS?



LET YOUR IMAGINATION LOOSE!

Design your own marvelous characters. Fill the blank figures with any colors and patterns you want. Turn this picture into a show everyone will remember!



LOOK AT HIM FLY!



BUILD A MONKEY PARTY POOL



I'M BORED. LET'S DO SOMETHING TOGETHER!

LET'S BUILD A POOL AND HAVE A POOL PARTY!

HAVE A POOL PARTY WITH YOUR FRIENDS!

Check the cool pool the monkeys have built. What would your swimming pool look like? Would it be round, or square? What colors would you use? Would you add some slides, trees, or toys? Use your imagination and have fun.



Share your party pool creation in the LEGO Life app Magazine Stuff group, and let others join the party.

1

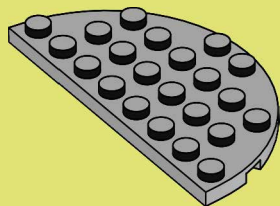

2

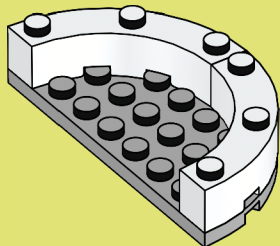

3

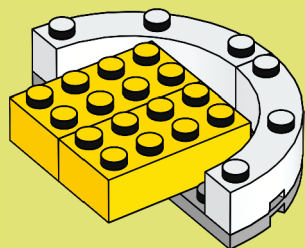

4

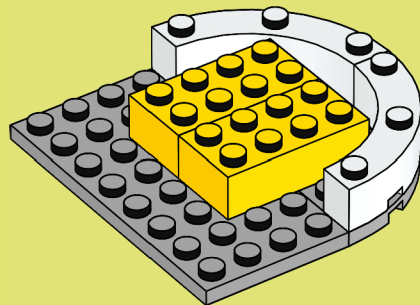

5

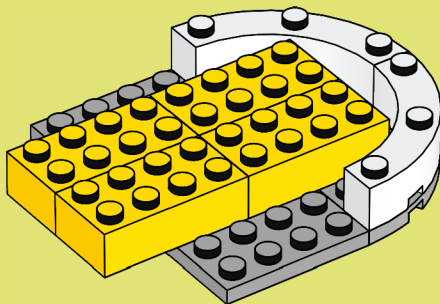

6

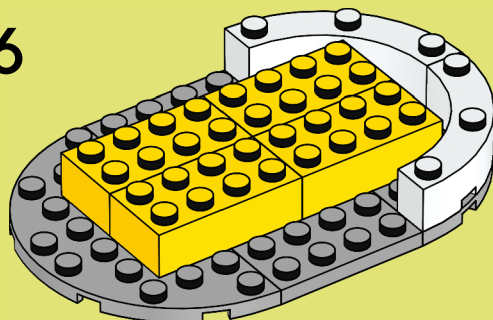

7

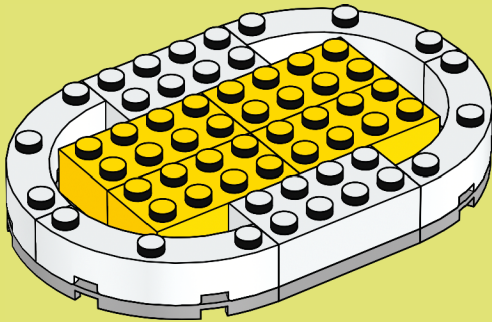

8

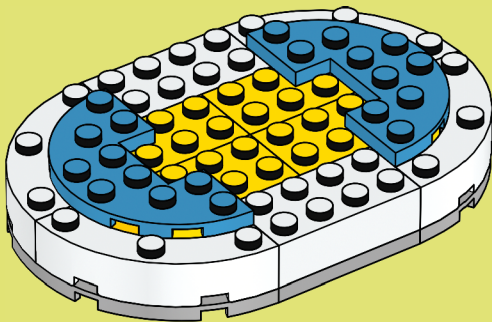

9

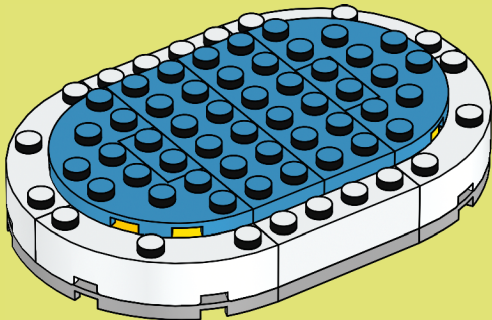

10

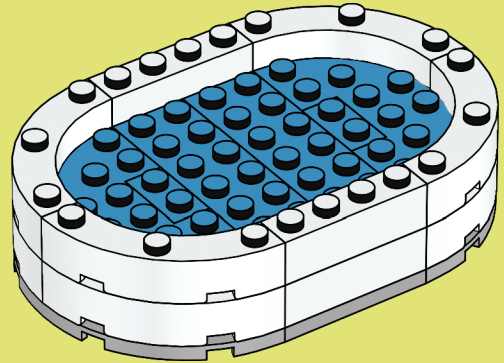

11

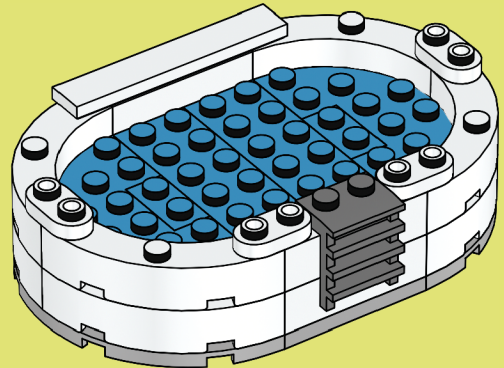

12

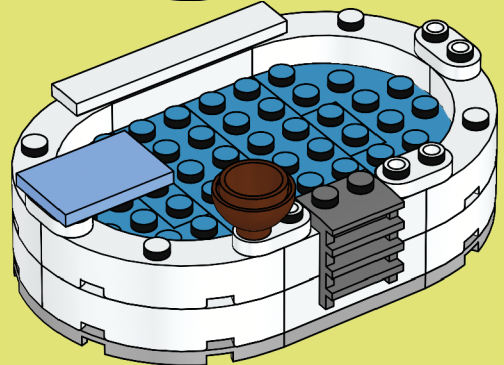

Do you want to find more inspiring building instructions? Get the free LEGO® Builder app and start building with digital instructions!



Don't forget to ask a grown-up's permission before downloading apps.

- Save your sets
- Zoom in
- Rotate your model while you build
- Track your building completion!

THE SOURCE OF POWER

Do you know what would happen if the ninjas lost their powers? And how can they get them back? Discover the real power that has roots deep within them – and you!

IN THE NINJA DOJO TEMPLE, KAI AND NYA ARE TRAINING THEIR ELEMENTAL POWERS.



HIYA!

UNLOCK FIRE!

I KNOW THAT OUR POWERS ARE GREAT, NYA ...



... BUT WHAT WOULD HAPPEN IF WE LOST THEM?

BUT KAI, THE SOURCE OF OUR POWERS LIES DEEP WITHIN US.



WE ARE NOT ONLY NINJAS, WE ARE ALSO HUMAN BEINGS ...

... AND IF WE FOLLOW HUMAN VALUES, WE CAN ALWAYS UNLOCK OUR ELEMENTAL POWERS!



BUT WHAT ARE THOSE VALUES? WHERE CAN I FIND THEM?

LET'S GO ON A JOURNEY. YOU WILL FIND OUT!



THE JOURNEY TO INNER POWER



Go on a journey with Nya and Kai and discover the source of Kai's power! Select where the ninjas go and who they help to create a story. Then make a comic about their adventure. Or unleash your creativity and create your own story!



- 1** Kai and Nya decided to go to the _____ ?
- A. Jungle
 - B. Desert
 - C. Mountains
 - D. Caves

- 2** There, they needed to use their powers to _____ ?
- A. Rescue a lost explorer
 - B. Help a trapped animal
 - C. Save a kid from a danger

NOW, DRAW KAI AND NYA ON THEIR JOURNEY.

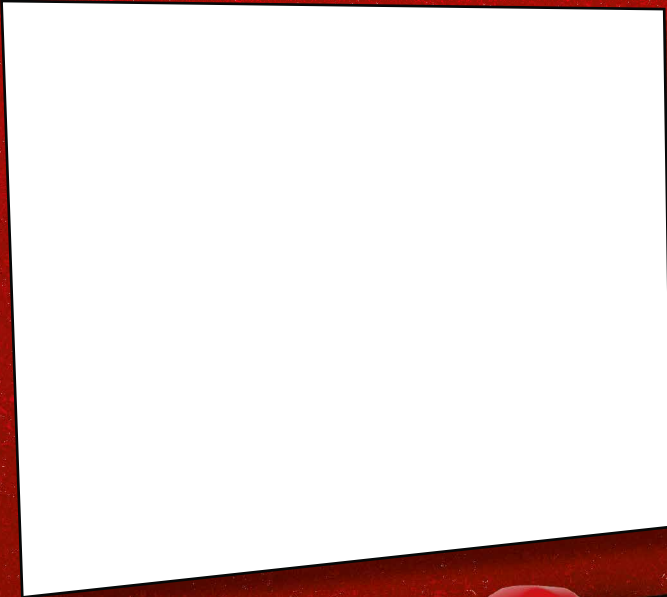

- 3** Then, Kai and Nya heard that a _____ is in danger.
- A. City
 - B. Village
 - C. Ship
 - D. Plane
- 4** Together, they rushed to fight the _____ .
- A. Pirates
 - B. Evil ninja
 - C. Fire
 - D. Ghosts

NOW, DRAW WHAT HAPPENED NEXT!



After he defeated the danger, Kai thought that what he loves to do, what brings out the best in him – is helping others. Suddenly, he realized that he knows what the source of his power is.



I KNOW THE SOURCE OF MY POWER! IT'S MY INNER

N I H A T M U Y
H _ _ _ N _ _ Y

Go on a journey to NINJAGO.com today and read more about ninja adventures!

Puzzled?
Check the answers on page 27.

COOL CREATIONS



Sunny Village
Lea, age 6,
Germany



Emmet's Beachside Ice-Cream Shop
Lily, age 10, USA



Mega-Scorpion-Mobile-X
Elliott, age 8, United Kingdom

Do you have an **AWESOME BUILD** you would like to share with other builders?

SEND US YOUR PHOTO!

- 1 Have a photo taken of you with your build. You might see it on this page in a future issue.
- 2 Ask a parent or guardian to go to LEGO.com/magazine.
- 3 There they can download and complete the Submission Form, then email it along with your photo. See the Submission Form for the email address.
- 4 Remember that you can send us a story about your model too. Tell us how you built it, what's going on in the scene, or whatever you like. Max also loves getting your letters!



LEGO Birthday Party
Laure, age 6, France



Crane
Niklas & Jan,
age 8 & 6,
Austria



Super Jumbo Water Park
Ava, age 4,
Canada



Big Carrier Truck
Hugo, age 5, New Zealand

INVITE YOUR FRIENDS TO BUILD TOGETHER. YOU WILL HAVE SO MUCH FUN!

THANKS TO EVERYONE WHO SENT IN THEIR CREATIONS. YOU ARE AWESOME! WE CAN'T WAIT TO SEE MORE OF YOUR AMAZING BUILDS.

LET'S CREATE A CARROT CASTLE!





LEGO® Village
Arthur & Beatrix, age 7 & 4, United Kingdom

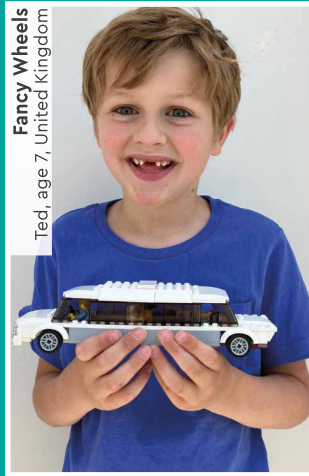

Fancy Wheels
Ted, age 7, United Kingdom



Large NINJAGO® Ninja Campus
Kimi, age 7, Germany



Seaplane
Yoden, age 4, United Kingdom



NINJAGO® Battle Ready!
Wes, age 8, USA



LEGO® Mansion
Ariella, age 8, Scotland



LEGO® City – My SWAT Command Center
Samuel, age 8, Germany



The Battle
Edward & Astrid, age 8 & 4, Sweden



The Rainbow Tower
Columbine, age 8, Denmark

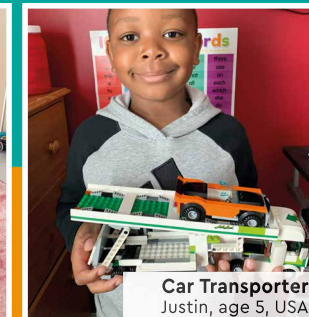

Car Transporter
Justin, age 5, USA

SOLUTIONS

LEGO® Brick Tales, p. 7:

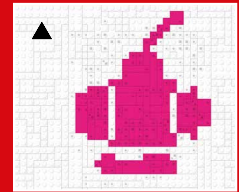
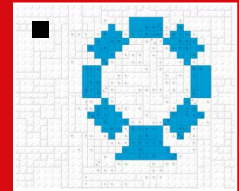
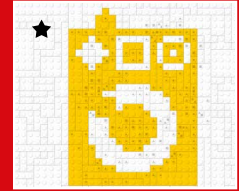

LEGO Minecraft®, p. 8–9:



LEGO® Super Mario™, p. 12:



LEGO Creator, p. 17:

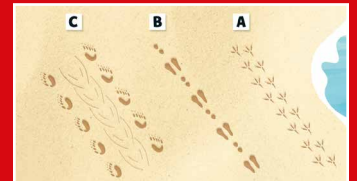

LEGO NINJAGO®, p. 25:
HUMANITY

Back cover:
page 3, page 5, page 26

Rebuild the world™

Next issue of the LEGO® Life Magazine out in March!



Are you still looking for the Carrot Man? Check where he hides on page 27.

WHERE IS THE CARROT MAN?
I WANT TO TAKE A PICTURE WITH ALL MY FRIENDS TO REMEMBER OUR AMAZING CELEBRATION OF THE CHINESE LUNAR NEW YEAR! BUT SOMEONE IS MISSING... HE MUST BE HIDING INSIDE THE LEGO® LIFE MAGAZINE. WILL YOU HELP ME FIND HIM?

Do you have an amazing creation you would like to share with the world?

Ask a grown-up to go to LEGO.com/magazine to download the submission form. It includes simple steps for sending your letters and Cool Creations to the LEGO® Life Magazine.