

THE MAGAZINE

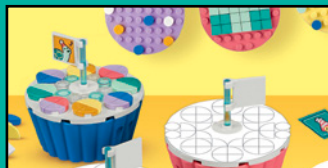

POSTERS



ACTIVITIES



COMICS

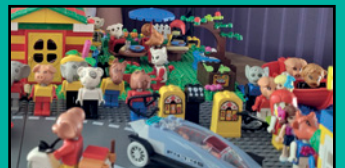

COOL CREATIONS

WELCOME TO ISSUE 1!

**XĪNNIÁN
KUÀILÈ!**
IT MEANS
"HAPPY NEW YEAR"
IN MANDARIN.

THESE LANTERNS
WE'RE MAKING
WILL LOOK GREAT FOR THE
LANTERN FESTIVAL.

CLEANING CAN BE
FUN ... RIGHT?

LET'S CELEBRATE
THE CHINESE YEAR
OF THE RABBIT WITH
SOME CARROTS!

THE ADVENTURES OF MAX RABBIT

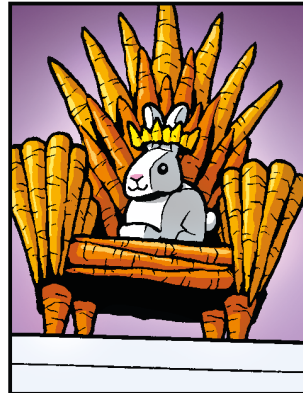
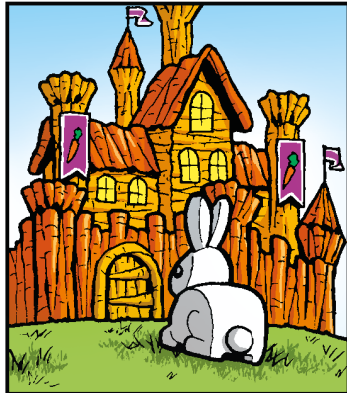
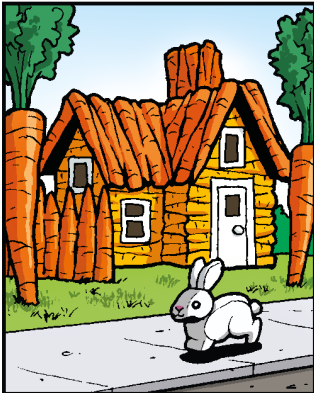

JUST FOR YOU!



Check out all the excitement in this issue! You will also see Max holding up his flag where pages have been created just for you. Look for him throughout the magazine!

PUZZLED?

Look for these icons on activity pages. They will tell you if the activity is easy, hard, or somewhere in between. Try them all and see how you do! **If you get stuck, the answers can be found on page 27.**





SOMETHING TELLS ME THE RABBIT WILL LOVE THIS!

THERE'S NOTHING BETTER THAN A PARTY THAT LASTS TWO WEEKS!

I LOVE THESE FIREWORKS!

THAT LOOKS YUMMY...

DON'T HAVE THE LEGO® LIFE APP YET?

Ask a parent or guardian to download it today for **FREE** from one of the app stores and sign in with your LEGO® Account.

Apple and the Apple logo are trademarks of Apple Inc., registered in the U.S. and other countries and regions. App Store is a service mark of Apple Inc. Google Play and the Google Play logo are trademarks of Google LLC.

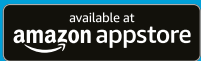

Hi, I'm Captain Safety!



Want to know more about how you can stay safe online? Look for me in the LEGO® Life app for tips on what you and your parents can do to make sure time online is fun and safe for everyone.

TELL US WHAT YOU THINK OF THIS MAGAZINE!

Ask a parent or guardian to **scan this code** or visit **LEGO.com/LIFESURVEY** to take the survey right away!



LEGO® Life Magazine

For information about LEGO® Life visit **LEGO.com/life**
 For questions about your membership visit **LEGO.com/service**
 or call **1-877-518-5346**

PO Box 1138
 Enfield, CT 06082

PO Box 600
 Markham, ON
 L3R 8G8



(US/CA)
 LEGO, the LEGO logo, the Minifigure, the Brick and Knob configurations, NINJAGO, the NINJAGO logo and the FRIENDS logo are trademarks and/or copyrights of the LEGO Group.
 ©2023 The LEGO Group. All rights reserved.

WHERE ARE MY CARROTS?



IT'S NEARLY TIME FOR OUR NEW YEAR PARTY! I'M GOING TO MAKE YUMMY CARROT DUMPLINGS FOR ALL OUR FRIENDS!

I'M SURE IT WON'T ALL GO WRONG LIKE LAST TIME YOU TRIED TO COOK!

DID SOMEONE SAY CARROT?



I THINK I HAVE EVERYTHING I NEED.

CARROTS?

WHAT ABOUT A LARGER TABLE?



WHERE ARE THE REST OF THE CARROTS? I ONLY HAD ENOUGH TO MAKE THREE CARROT DUMPLINGS!

NO! THEY'RE MINE NOW! ALL MINE!

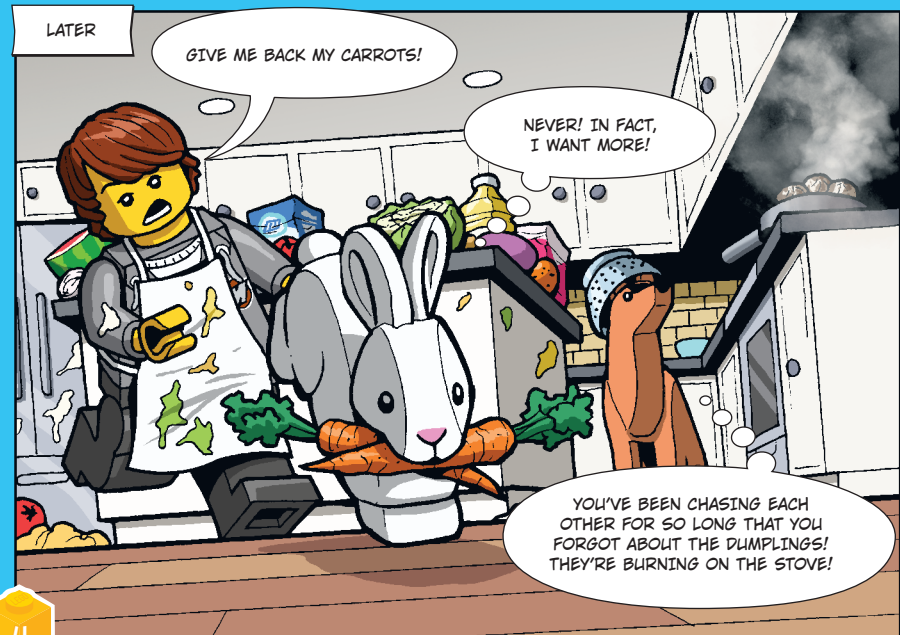

LATER

GIVE ME BACK MY CARROTS!

NEVER! IN FACT, I WANT MORE!

YOU'VE BEEN CHASING EACH OTHER FOR SO LONG THAT YOU FORGOT ABOUT THE DUMPLINGS! THEY'RE BURNING ON THE STOVE!



OH NO! THE DUMPLINGS HAVE BURNED!

AT LEAST I MANAGED TO SAVE THESE CARROTS! I'M A HERO!



THERE'S NO TIME TO MAKE NEW DUMPLINGS! SHOULD I JUST ORDER A PIZZA?

PIZZA? I'LL HAVE A PIZZA!

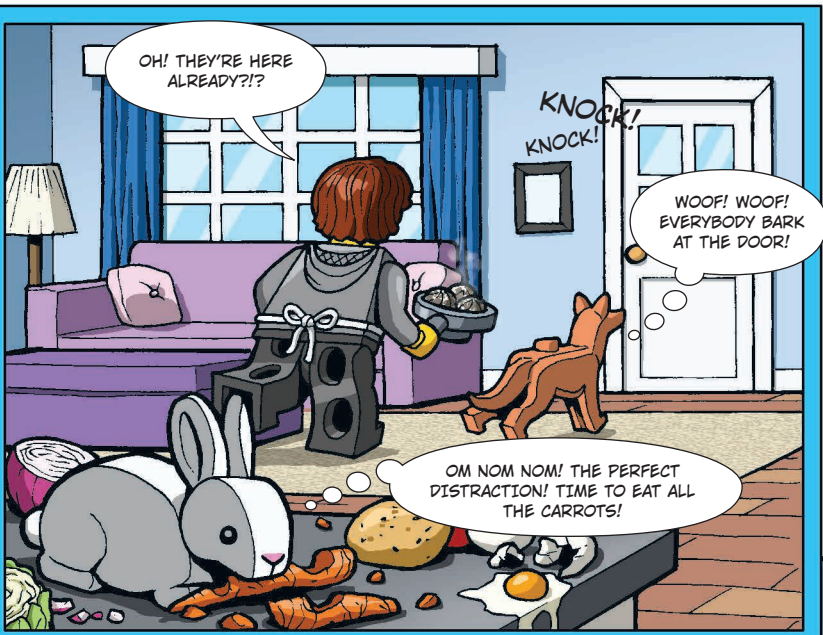

OH! THEY'RE HERE ALREADY?!

KNOCK!
KNOCK!

WOOF! WOOF!
EVERYBODY BARK AT THE DOOR!

OM NOM NOM! THE PERFECT DISTRACTION! TIME TO EAT ALL THE CARROTS!

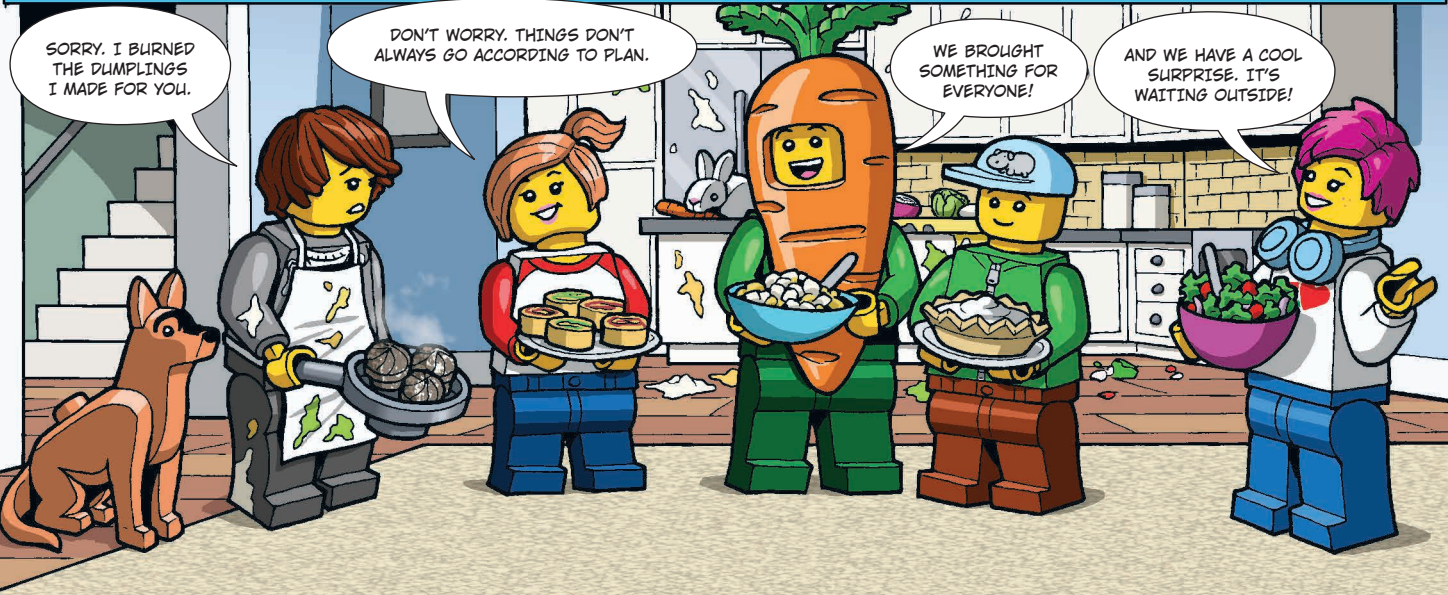

SORRY. I BURNED THE DUMPLINGS I MADE FOR YOU.

DON'T WORRY. THINGS DON'T ALWAYS GO ACCORDING TO PLAN.

WE BROUGHT SOMETHING FOR EVERYONE!

AND WE HAVE A COOL SURPRISE. IT'S WAITING OUTSIDE!

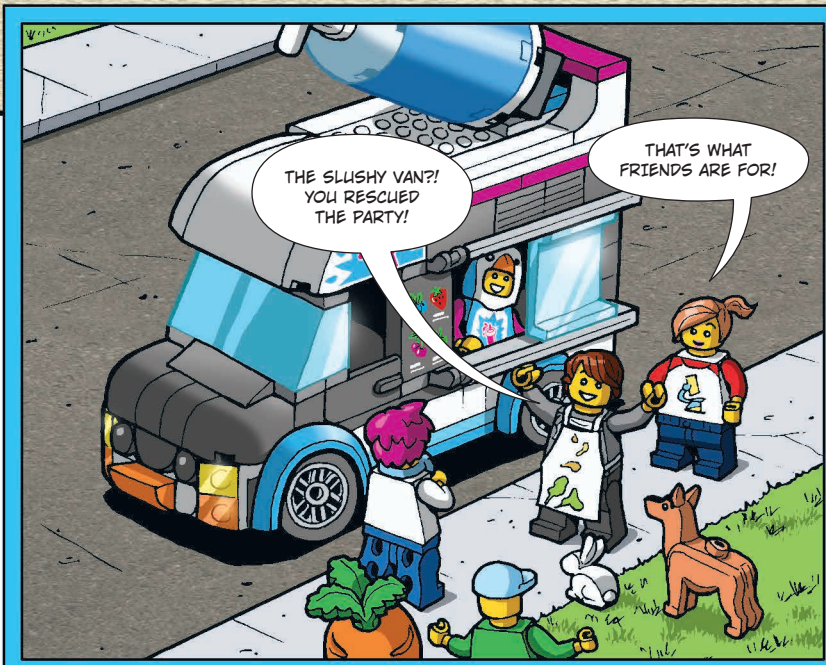

THE SLUSHY VAN?! YOU RESCUED THE PARTY!

THAT'S WHAT FRIENDS ARE FOR!



WE HEARD YOU HAD A RABBIT, SO WE EVEN BROUGHT CARROT SLUSHIES!

NO, THANK YOU! I ALREADY ATE TOO MANY CARROTS!

WHAT'S YOUR SUPERPOWER?

NEW!



MARVEL STUDIOS
THE INFINITY
SAGA

Each one of us has a superpower! Even if we don't always know about it. Which fantastic skill might be an ace up your sleeve? Are you as confident as Thor? Loyal as Captain America? Or maybe you have Black Widow's wits? Discover your superpower in our super quiz!

MY HAMMER AND I ARE INVINCIBLE!

FRIENDSHIP MAKES YOU EVEN MORE POWERFUL.

I'LL ESCAPE YOU ANYWAY BECAUSE I'M THE SMARTEST. MUAHAHAHAHA!



WHAT COULD BE YOUR SUPERPOWER?

Answer the questions and discover your super-talent.

1. IT'S THE MIDDLE OF THE NIGHT AND YOU HEAR SUSPICIOUS NOISES IN YOUR BEDROOM. YOU...

- A** Turn the light on and stand on your tiptoes to look taller.
- B** Throw LEGO® bricks on the floor, hoping the villain will step on them.
- C** You jump out of your bed to check if your parents are OK.

2. DO YOU LIKE GETTING UP EARLY?

- A** You are not afraid of anything, even the alarm clock set for 7:00 AM!
- B** Why would anyone wake up early and leave this cozy, warm bed?
- C** The earlier the better, more time for fun!

3. WHAT'S YOUR FAVORITE PLACE IN THE WORLD?

- A** A cave in the mountains that hides mysterious secrets.
- B** A playground in the park, where you can jump, swing, and climb.
- C** A yard where you can play with your friends... and win!

4. IF YOU WERE TO TURN INTO AN ANIMAL FOR ONE DAY, YOU WOULD LIKE TO BE:

- A** An eagle.
- B** A cougar.
- C** A bear.

NOW, COUNT THE ANSWERS.

You'll find out what superpower you have! Ask your friends which superpower suits you best if you have a draw.

MOST **A** ANSWERS

Some of the greatest of **Captain America's** virtues are his loyalty and bravery, and that he never gives up. Sounds familiar?



MOST **B** ANSWERS

Black Widow is skilled and fast... but also has a great sense of humor. Is that you? Your friends would agree!



MOST **C** ANSWERS

If you need someone solid and reliable, **Thor** is your go-to superhero. He also enjoys adventures, and just like you is always prepared to carry something heavy for the rest of the group!



THE MAGICAL HOUSE OF ENCANTO



FIND OUT WHAT HAS CHANGED

The Madrigal house can't decide how it should look today. It has been changing almost as much as the weather. Compare the two images of the Madrigal House and find ten differences between the casitas.

Need Help? Answers can be found on page 27.

Help Antonio find his pet!

Antonio's capybara Chispi found her favorite spot! But which house is she hiding in?

CHISPI, WHERE ARE YOU?



WHY DOES CASITA LOOK SO DIFFERENT?

Disney
ENCANTO



THE RACE FOR THE YUMMY SLUSHY

NEW!



After all the fun of biking and tent sleeping, a father and his daughter return from the off-road camp to LEGO® City. The family dreams about the cold, yummy slushies from the Penguin Slushy Van. But there are still a couple of surprises on the way. **Who will get first to the Penguin Slushy Van before all the slushies melt?**



START!

How to play:

- Choose a LEGO minifigure for each player – it will be your playing piece.
- Put your playing piece in the Start space.
- Use a LEGO brick as a dice. The youngest player goes first.
- Roll the LEGO brick to find out how many spaces to move.
 - If the brick lands studs side up, go one space
 - If it lands studs side down, go two spaces
 - If it lands on its side, go three spaces
- If you stumble upon a hypnotizing scorpion, a cute rabbit, or a cactus, you stop to admire them and wait one turn!
- The first player to reach the Penguin Slushy Van wins!

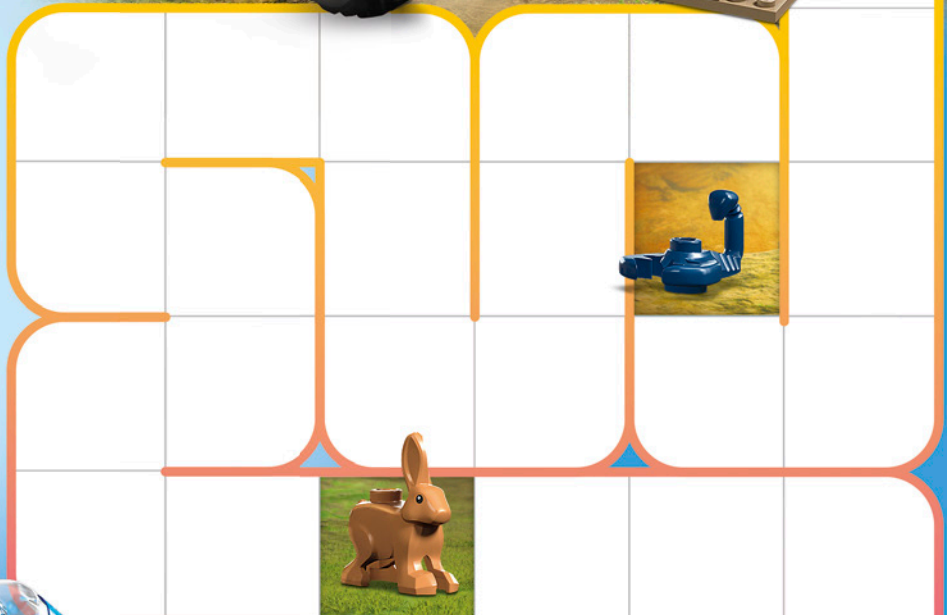

FINISH!



THE BROKEN CANNON



It's a happy day for the 501st Clone Troopers. They just got their new cannon. But wait. There's something wrong...



HELP THE CLONE TROOPERS FIX THE CANNON

The cannon needs energy from the Kyber crystals. But the crystals are empty! Pick your favorite colors and fill the crystals with them to give them energy.

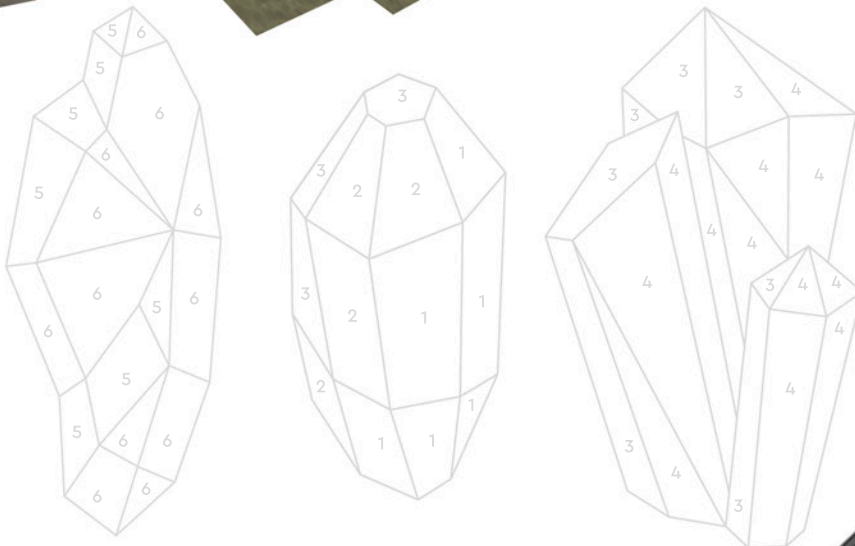

You can also use the numbers below to color the crystals.

1. 2. 3. 4. 5. 6.



THE COSMIC PUZZLE



IT WOULD BE GREAT TO HAVE A SCIENCE LESSON OUTSIDE TODAY!

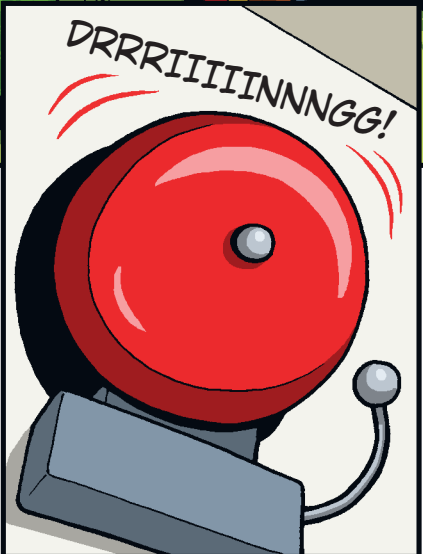

DRRRRIINNNGG!



I WISH WE COULD STAY HERE AND PLAY SOCCER.

WE CAN'T BE LATE!



LOOK! WHAT IS IT? I THINK IT'S AN ALIEN EYE!

THIS IS WHAT ZAC IS SEEING...

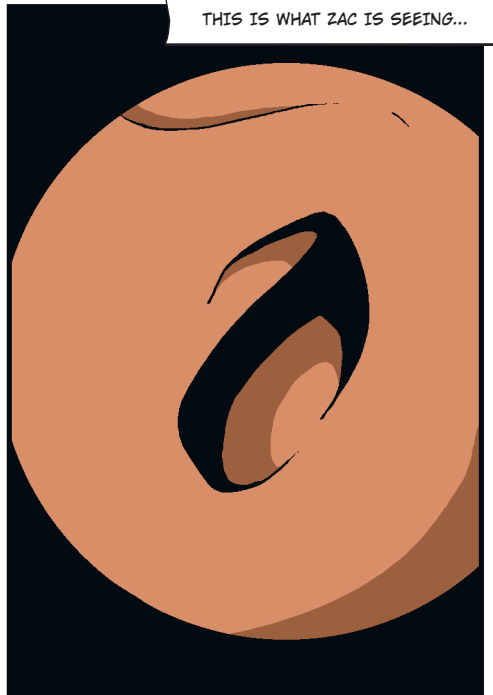



THAT CAN'T BE TRUE!

TIME FOR THE INTERGALACTIC SOCCER MATCH!

WE WILL BE FAMOUS!

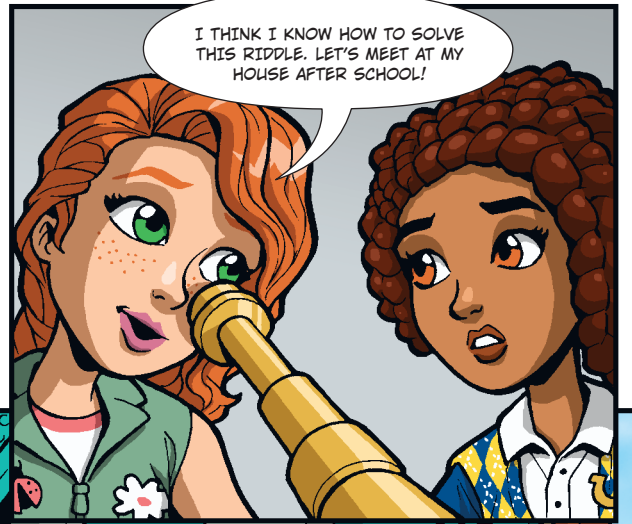

I THINK I KNOW HOW TO SOLVE THIS RIDDLE. LET'S MEET AT MY HOUSE AFTER SCHOOL!

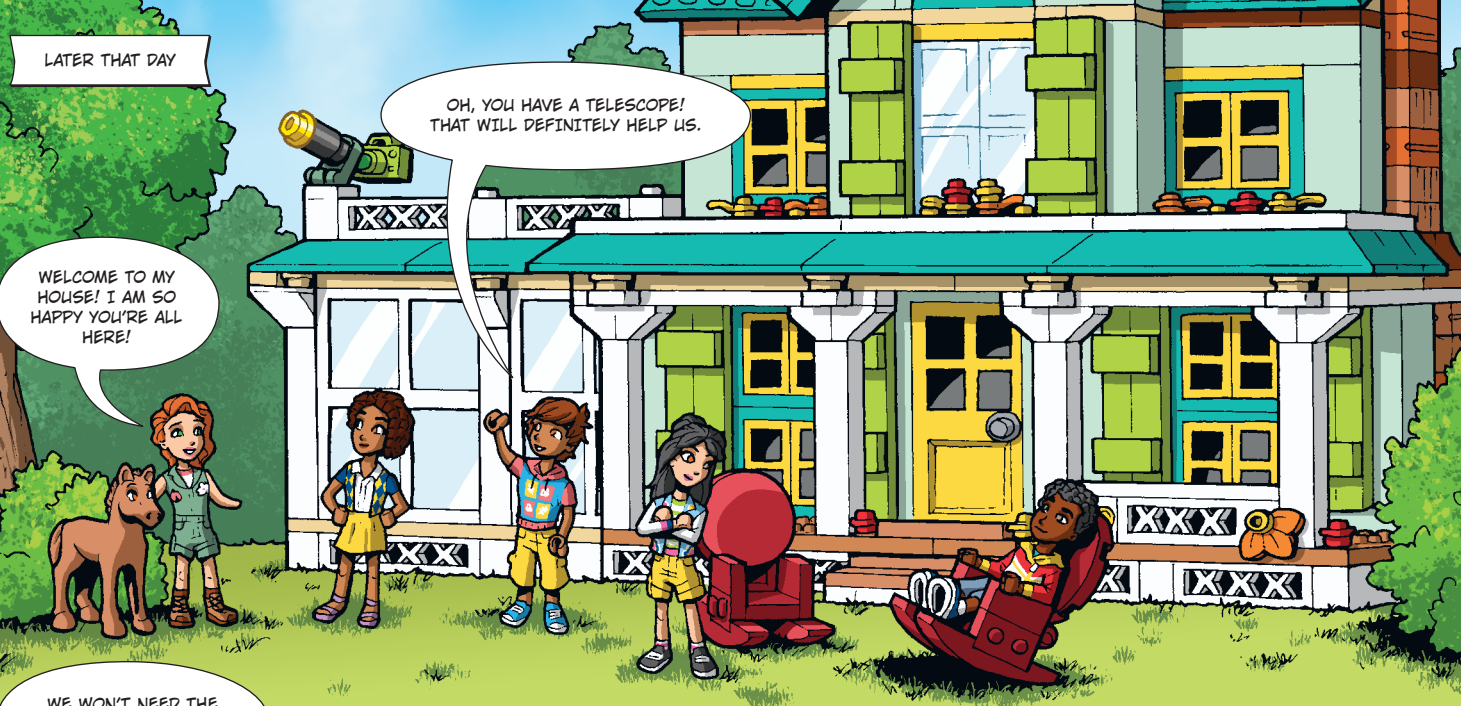

LATER THAT DAY

OH, YOU HAVE A TELESCOPE! THAT WILL DEFINITELY HELP US.

WELCOME TO MY HOUSE! I AM SO HAPPY YOU'RE ALL HERE!



WE WON'T NEED THE TELESCOPE, BUT THIS WILL COME IN HANDY.

OH! YOU HAVE A PICTURE OF THIS STRANGE THING WE SAW THROUGH THE TELESCOPE. BUT HOW?

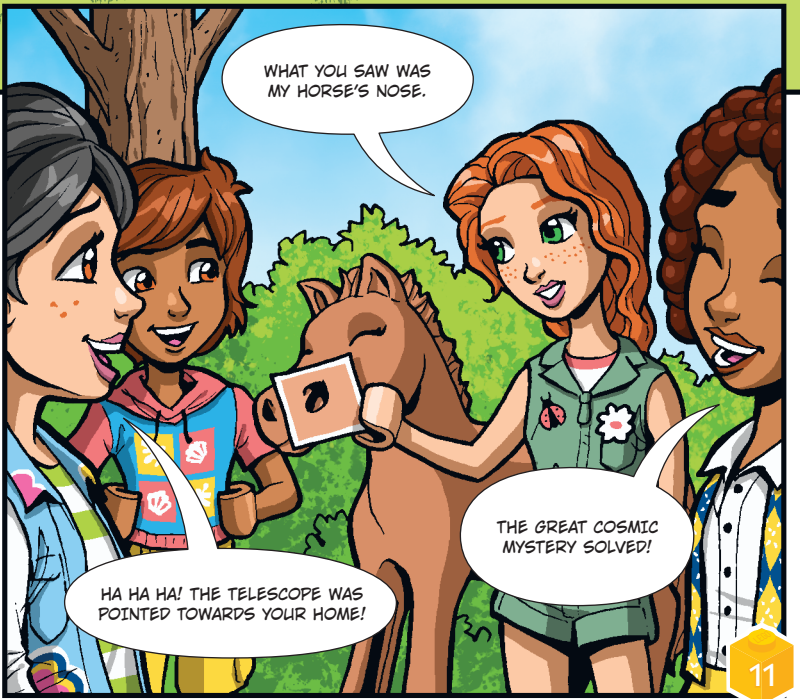

WHAT YOU SAW WAS MY HORSE'S NOSE.

HA HA HA! THE TELESCOPE WAS POINTED TOWARDS YOUR HOME!

THE GREAT COSMIC MYSTERY SOLVED!

WHERE ARE THE MISSING PIECES?



The LEGO® Super Mario™ universe is full of fun ways to build your own unique levels! Here's your chance to build one. Can you find the missing pieces below and complete the image?

SOLVE THE PUZZLE

Match the squares with the blank spaces in the set.

Need Help? Answers can be found on page 27.



Looking for more puzzles, action and fun? Check the LEGO® Super Mario™ group in the LEGO Life app.

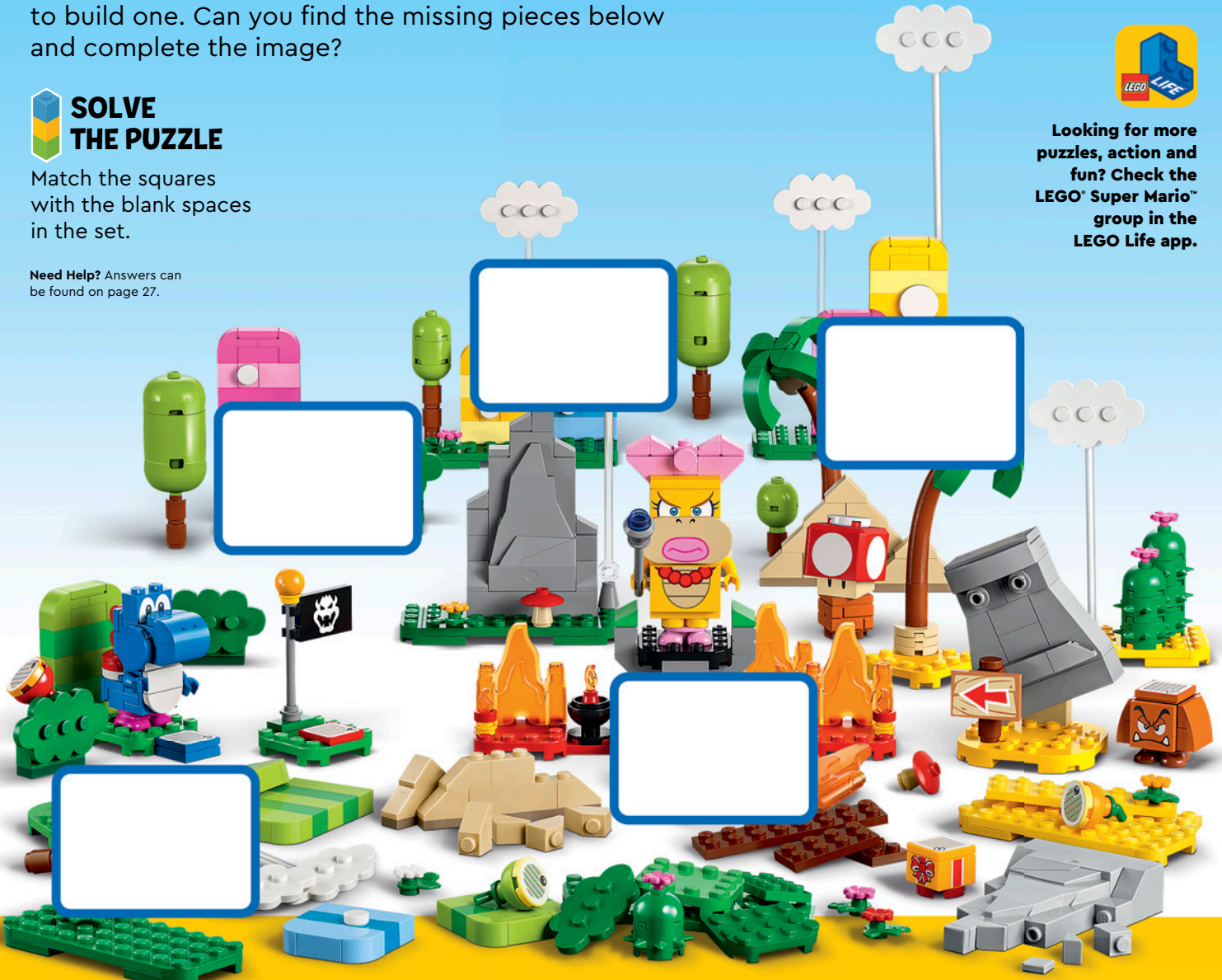

1

2

3

4

5

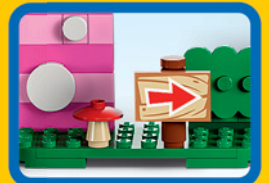

LET'S MAKE FRIENDS

I WONDER IF THEY HAVE A RUNNING WHEEL CLASS.

SCHOOLS

WOW, WE ARE A SUPER TEAM!

LEO

I LIKE YOUR OUTFIT!

THANKS, I MADE IT MYSELF.

OLLY

THAT WAS EASY!

ALIYA

AUTUMN





SOMETIMES CODING IS EASIER THAN TALKING.

PAISLEY

YOU SHOULD TRY SINGING!

NOVA

AWESOME. DO IT AGAIN!

I COULD DO IT ALL DAY, DON'T WORRY.

LIANN

ZAC

CITY

LEGO

YOUR CITY
NO LIMITS





ANIMALS OF THE WORLD



A cockatoo, rabbit and a seal share the same color, but not a home. Each animal has their favorite environment. Seals prefer living on an iceberg or a pebbly beach. At the same time, rabbits enjoy hiding in the tall grass, and cockatoos prefer somewhere in the jungle. Choose one natural habitat from the photographs and draw it around each animal.

NEW!

A



MOUNTAIN FOREST



SAVANNA



JUNGLE

B



FOREST



MEADOW



WETLANDS

C



SEA



SEA ICE



PEBBLE BEACH



The three animals met at the beach for fun and games. Which animal left the footprints in the sand? Write the correct letter in the box.

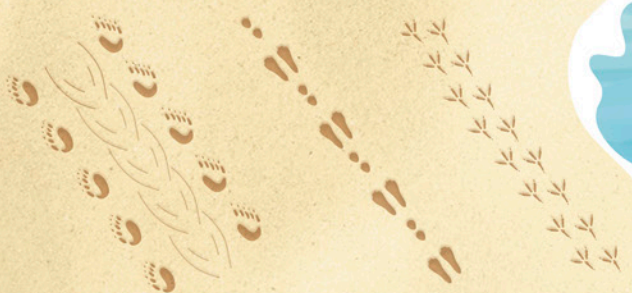

Need a little help? You can find the solution on page 27.



LET'S CELEBRATE FRIENDSHIP!

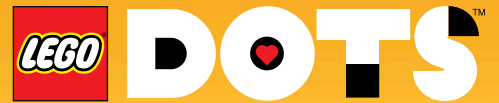

How about a cupcake party for your friend? Everything is almost ready. The only thing to do is to decorate the DOTS treats. Color in the cupcakes using your friend's favorite colors. You can even draw in extra shapes using LEGO® bricks or add stickers you may have at home.



A BRACELET FOR YOUR FRIEND!

Show your best friend what they mean to you. Decorate friendship bracelets for both of you.

ARE YOU UP FOR THIS MONSTROUS CHALLENGE?



Can you hear the roar? The monster trucks are in the arena, getting ready for the race. Look, Monster Jam™ Dragon™ just got to the finish. Can you find your way? Jump behind the wheel of Monster Mutt™ Dalmatian and conquer the maze thanks to the massive tires! Remember, you can go over ramps, but don't hit the sides.



Are you stuck? Race to page 27 to find the solution.

BUILD YOUR OWN MONSTROUS CHALLENGE

Create a track for **Monster Jam™** and share it with the world. Find out more on page 26.

©2023 Feld Motor Sports, Inc.

MONSTER JAM™, DRAGON™, MONSTER MUTT™ DALMATIAN and all related logos and characters/designs are intellectual property of and used under license from Feld Motor Sports, Inc. All rights reserved.

GET READY FOR

THE MAGICAL JOURNEY!



Rapunzel, Cinderella and Jasmine are going to set off soon. But they have lost some parts of their vehicles and need to find them first. Help them look for the misplaced elements and check the box when you find one.

Need Help? Answers can be found on page 27.



A flower from Rapunzel's hot air balloon



A cushion from Jasmine's flying carpet



A wheel from Cinderella's open horse carriage



A tassel from Jasmine's flying carpet

How is the baby elephant feeling about the journey?
Can you name this emotion?

- Nervous
- Happy
- Surprised



HOP INTO THE FUN



Spidey and his friends are skateboarding, shooting hoops, and dancing at the Webquarters. But wait, the Green Goblin stole and stashed their snacks. Can you find the five stolen pizzas?



MUSICAL SURPRISE

Connect all the numbers in the picture to find out what kind of surprise Miles Morales has prepared for his friends.

Need Help? Answers can be found on page 27.



BUILD A MONKEY PARTY POOL



LEGO CLASSIC

HAVE A POOL PARTY WITH YOUR FRIENDS!

Check the cool pool the monkeys have built. What would your swimming pool look like? Would it be round, or square? What colors would you use? Would you add some slides, trees, or toys? Use your imagination and have fun.



Share your party pool creation in the LEGO Life app Magazine Stuff group, and let others join the party.

1

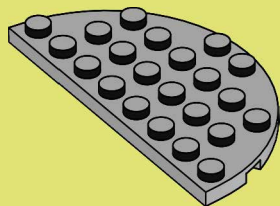

2

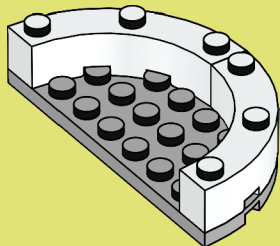

3

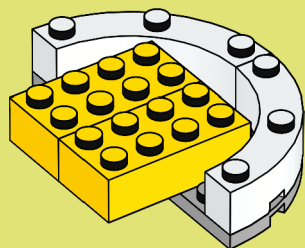

4

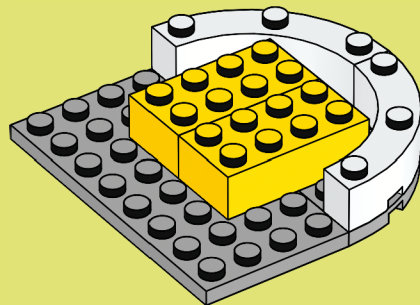

5

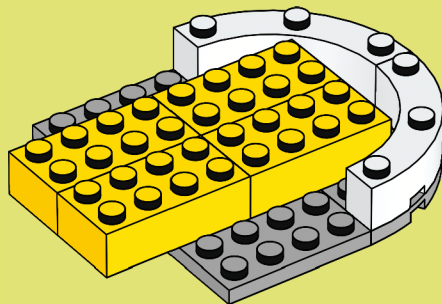

6

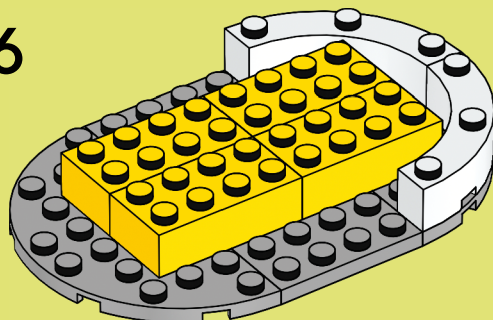

7

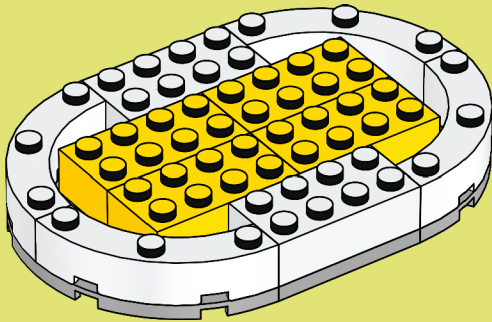

8

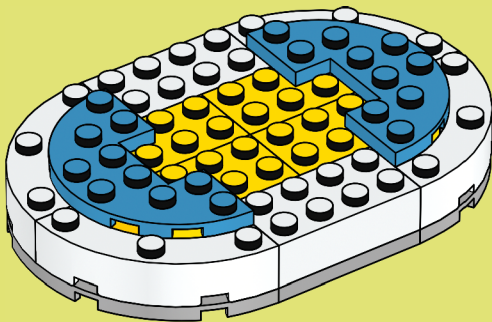

9

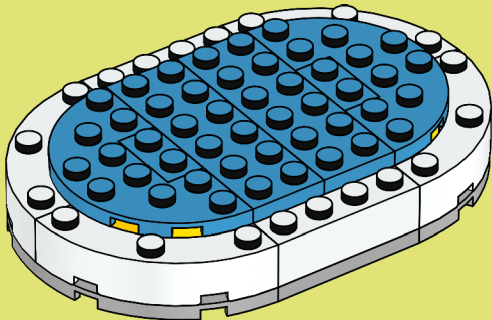

10

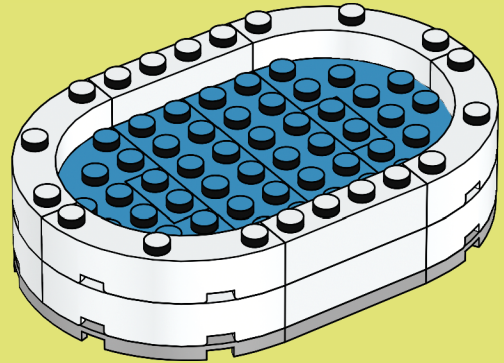

11

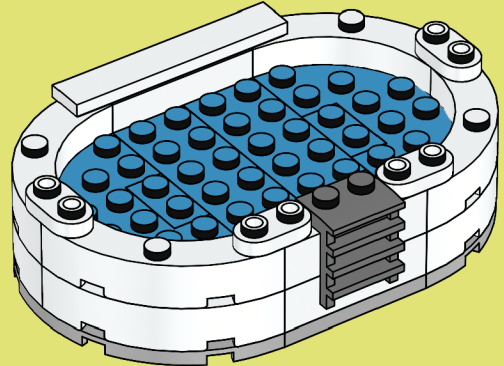

12

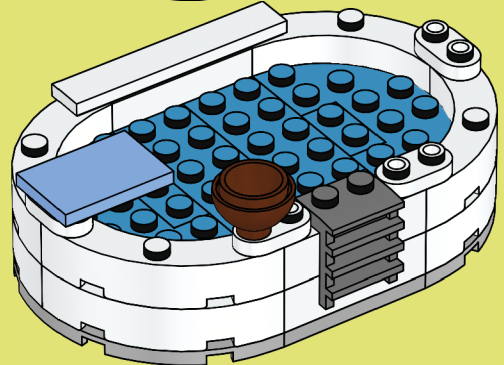

WOW! THIS IS A COOL POOL! PARROTS CAN JOIN THE PARTY, TOO.

I'M A PARROT, NOT A DUCK. I CAN'T SWIM.



Do you want to find more inspiring building instructions? Get the free LEGO® Builder app and start building with digital instructions!



Don't forget to ask a grown-up's permission before downloading apps.

- Save your sets
- Zoom in
- Rotate your model while you build
- Track your building completion!

THE LOST POWER

Kai and Nya defeated the mighty Crystal King. But they used all their power to create an elemental dragon. Now, they wonder what to do. Can they get their powers back?



DISCOVER THE POWER OF TEAMWORK

Help Kai and Nya. Solve the puzzles to get their powers back. You can ask a friend for help. Together, you will have even more power!











GET READY FOR THE CHALLENGE!

NINJADOKU

Help Kai get his power back! Draw four elements to fill the square. Each row and column can have only one of each elemental power: fire, lightning, earth and ice.

TOGETHER WE CAN DO THIS!

Need Help? Answers can be found on page 27.



NINJA'S NEW WEAPON

Draw a new sword for the ninjas. This can be the most powerful sword they have.



YOUR SWORD LOOKS AMAZING!

COOL CREATIONS



Sunny Village
Lea, age 6,
Germany



Emmet's Beachside Ice-Cream Shop
Lily, age 10, USA



Mega-Scorpion-Mobile-X
Elliott, age 8, United Kingdom

Do you have an **AWESOME BUILD** you would like to share with other builders?

SEND US YOUR PHOTO!

- 1 Have a photo taken of you with your build. You might see it on this page in a future issue.
- 2 Ask a parent or guardian to go to LEGO.com/magazine.
- 3 There they can download and complete the Submission Form, then email it along with your photo. See the Submission Form for the email address.
- 4 Remember that you can send us a story about your model too. Tell us how you built it, what's going on in the scene, or whatever you like. Max also loves getting your letters!



LEGO Birthday Party
Laure, age 6, France



Crane
Niklas & Jan,
age 8 & 6,
Austria



Super Jumbo Water Park
Ava, age 4,
Canada



Big Carrier Truck
Hugo, age 5, New Zealand

INVITE YOUR FRIENDS TO BUILD TOGETHER. YOU WILL HAVE SO MUCH FUN!

THANKS TO EVERYONE WHO SENT IN THEIR CREATIONS. YOU ARE AWESOME! WE CAN'T WAIT TO SEE MORE OF YOUR AMAZING BUILDS.

LET'S CREATE A CARROT CASTLE!





LEGO® Village
Arthur & Beatrix, age 7 & 4, United Kingdom

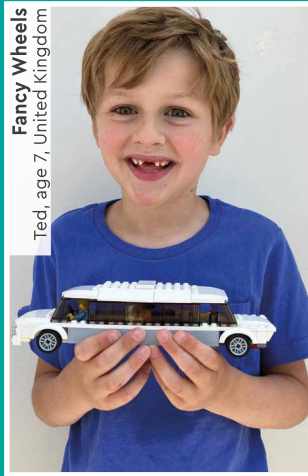

Fancy Wheels
Ted, age 7, United Kingdom



Large NINJAGO® Ninja Campus
Kimi, age 7, Germany



Seaplane
Yoden, age 4, United Kingdom



NINJAGO® Battle Ready!
Wes, age 8, USA



LEGO® Mansion
Ariella, age 8, Scotland



LEGO® City – My SWAT Command Center
Samuel, age 8, Germany



The Battle
Edward & Astrid, age 8 & 4, Sweden



The Rainbow Tower
Columbine, age 8, Denmark



Car Transporter
Justin, age 5, USA

SOLUTIONS

LEGO® | Disney, p. 7:



LEGO® Super Mario™, p. 12:



LEGO Creator, p. 17:

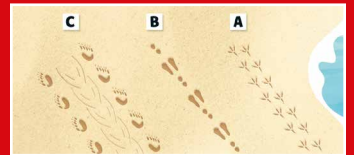

LEGO Technic™, p. 19:



LEGO | Disney, p. 20:



LEGO Marvel Spidey, p. 21:



LEGO NINJAGO®, p. 25:



Back cover:
page 3, page 5, page 26

Rebuild the world™

Next issue of the LEGO® Life Magazine out in March!



**WHERE IS THE
CARROT MAN?**

I WANT TO TAKE A PICTURE WITH ALL MY FRIENDS TO REMEMBER OUR AMAZING CELEBRATION OF THE CHINESE LUNAR NEW YEAR! BUT SOMEONE IS MISSING... HE MUST BE HIDING INSIDE THE LEGO® LIFE MAGAZINE. WILL YOU HELP ME FIND HIM?

Are you still looking for the Carrot Man? Check where he hides on page 27.

Do you have an amazing creation you would like to share with the world?

Ask a grown-up to go to LEGO.com/magazine to download the submission form. It includes simple steps for sending your letters and Cool Creations to the LEGO® Life Magazine.