

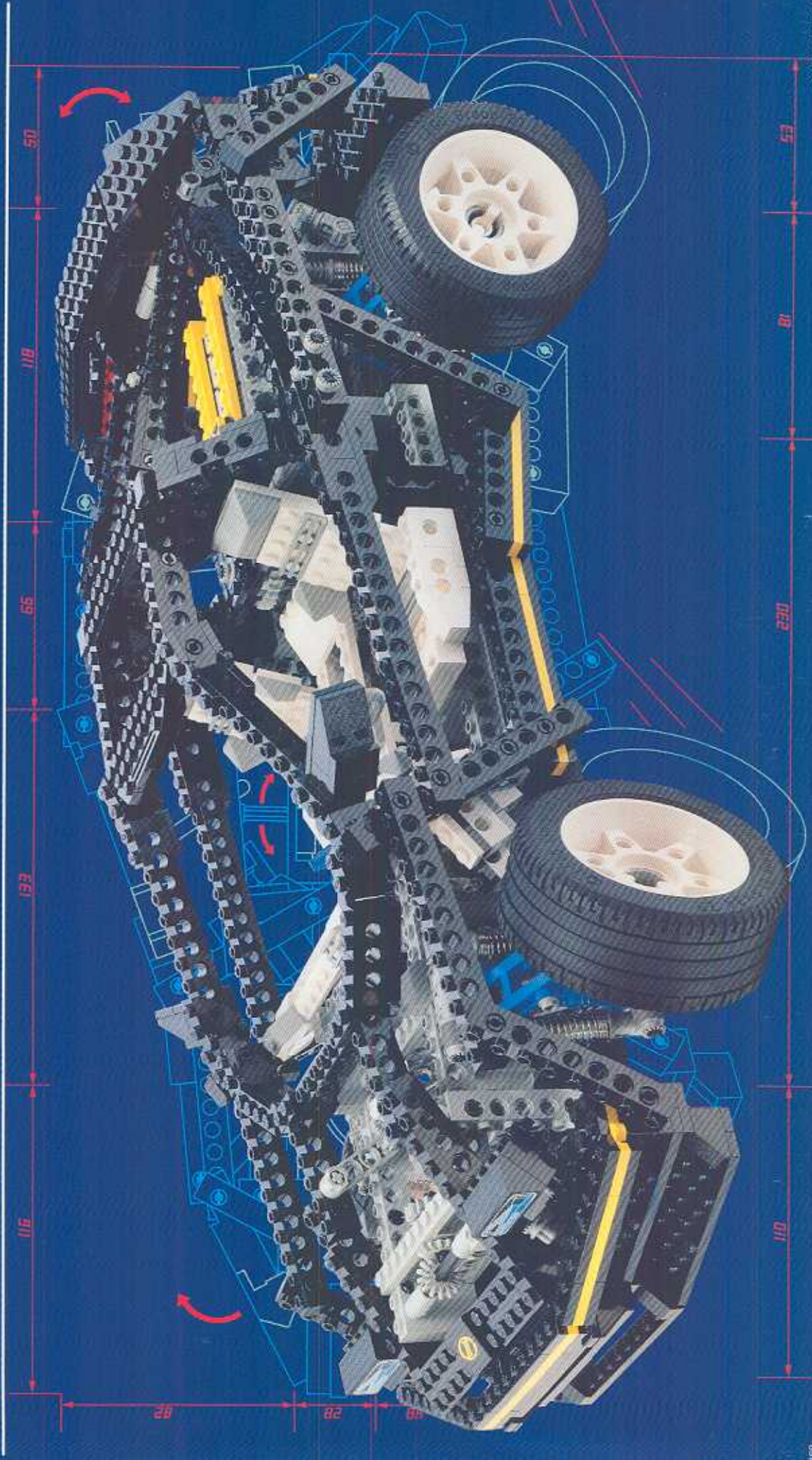

Technic

8880

Model 1/2: 1-54
Model 2/2: 55-92



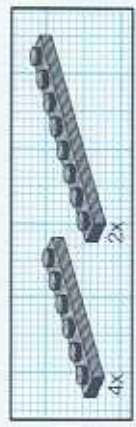
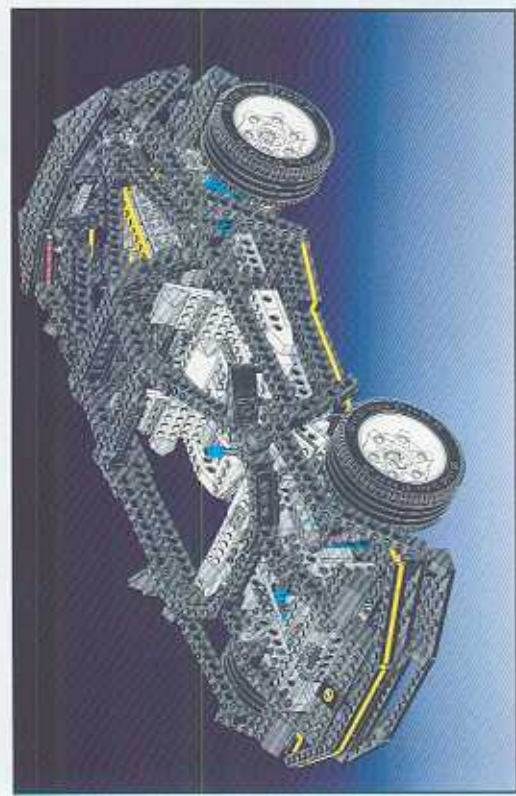
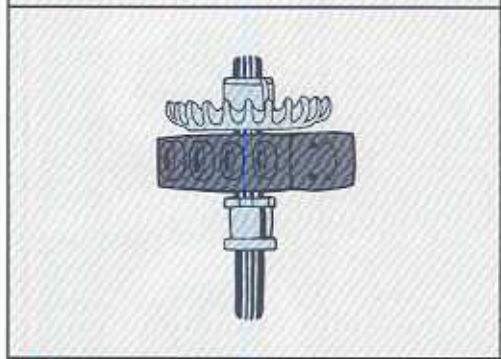
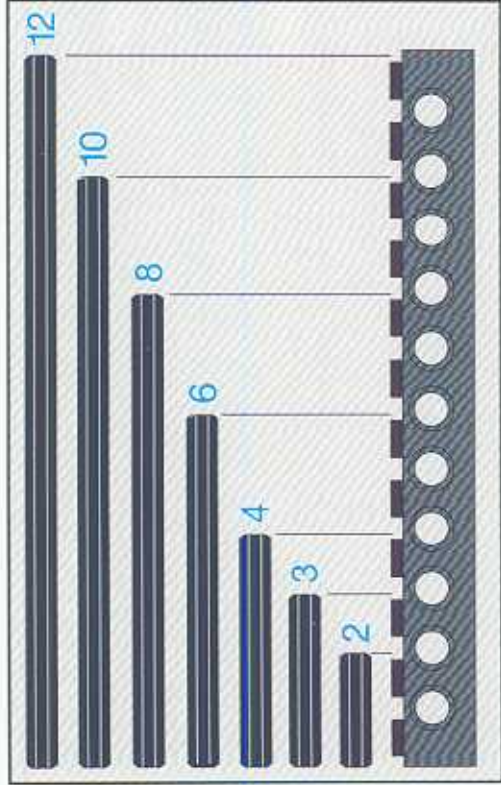



2

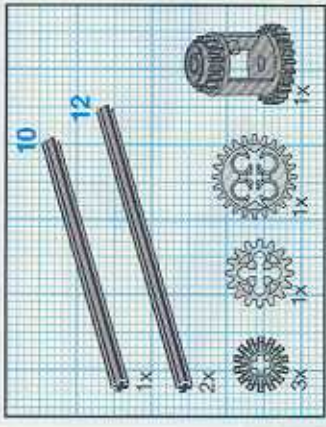

3

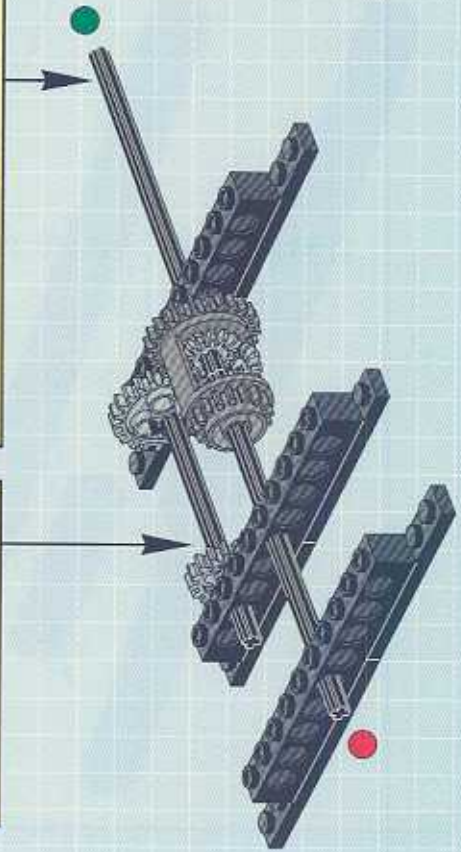
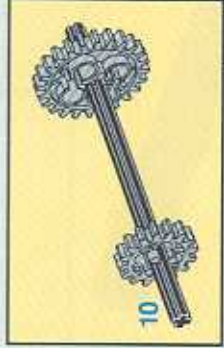
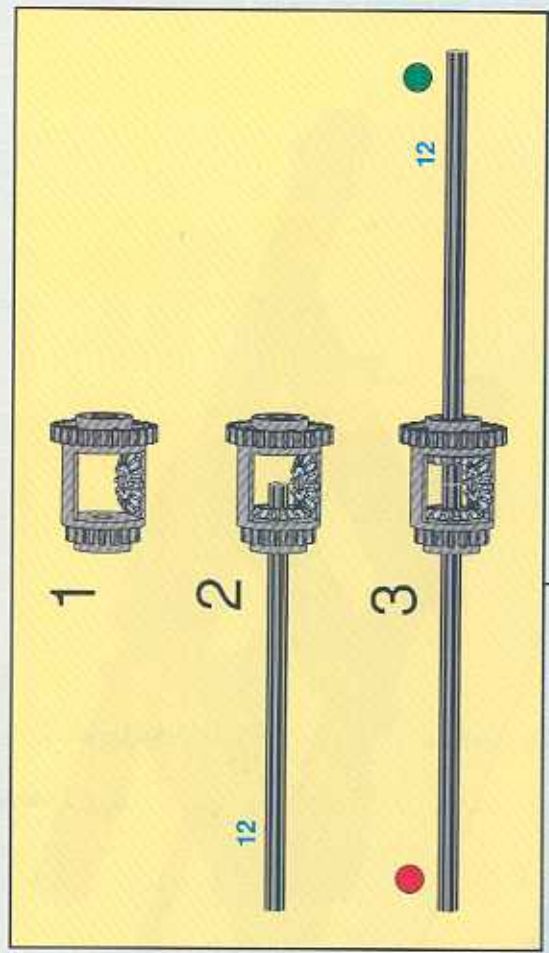
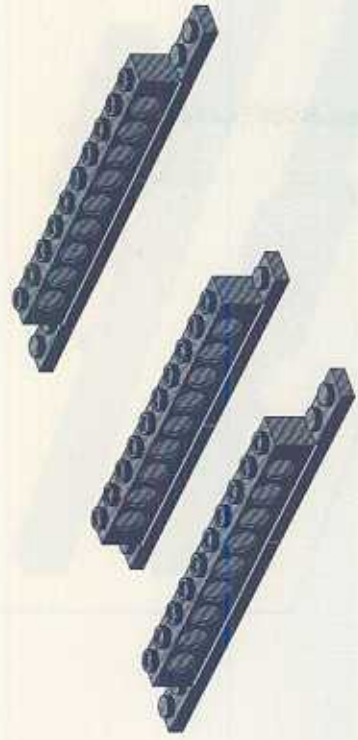

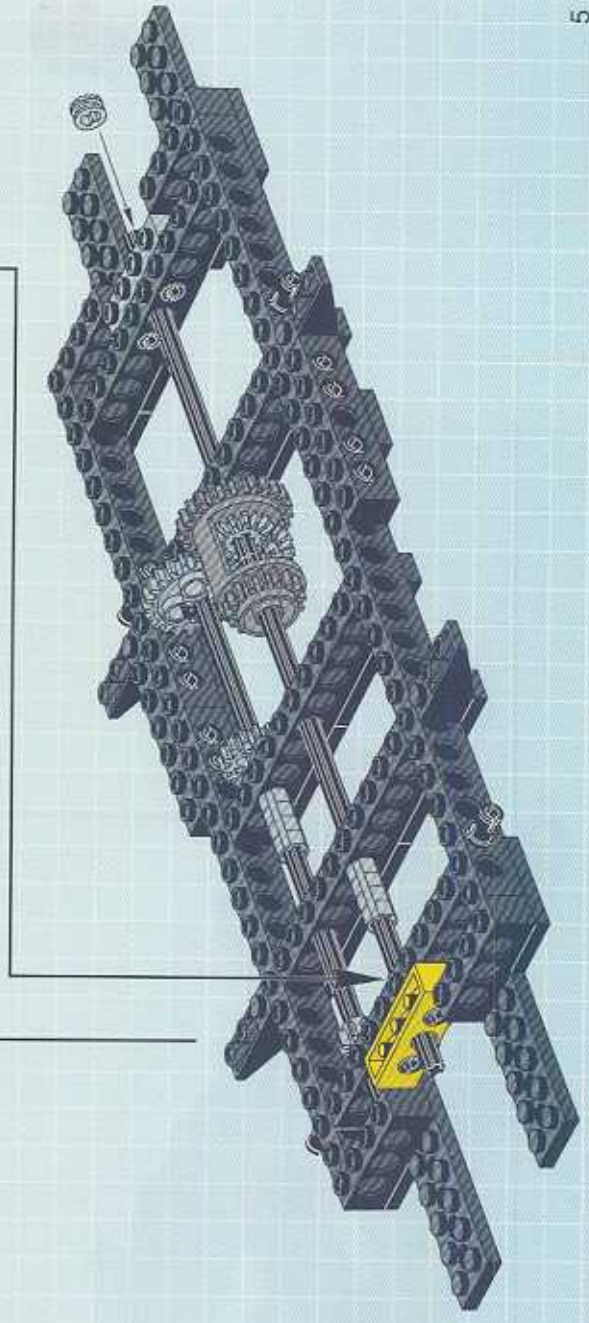
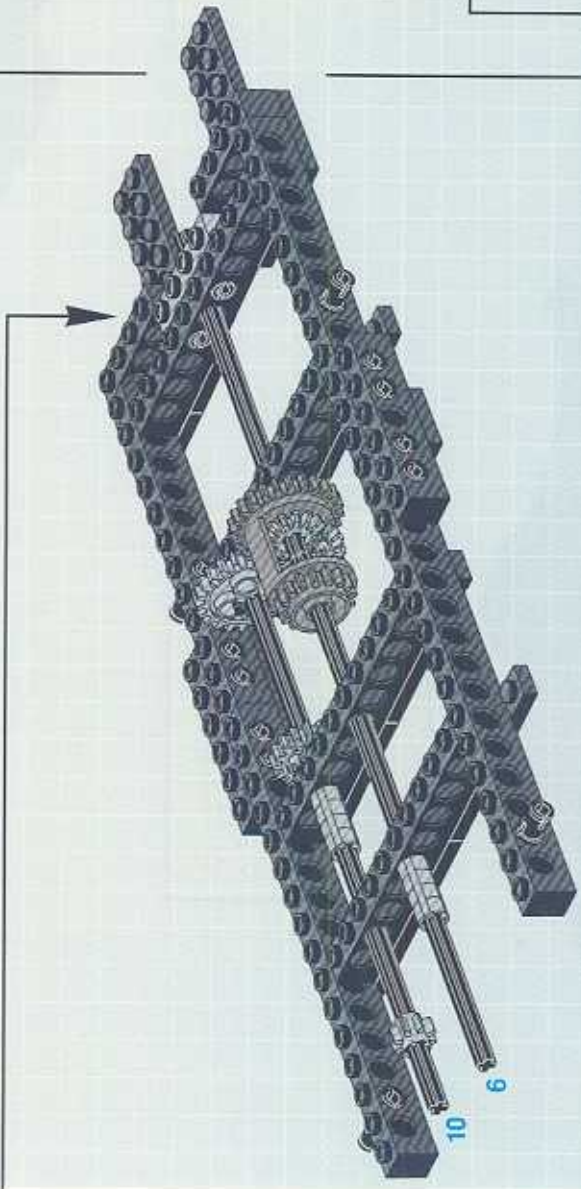
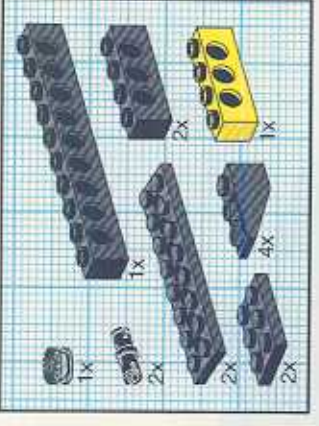
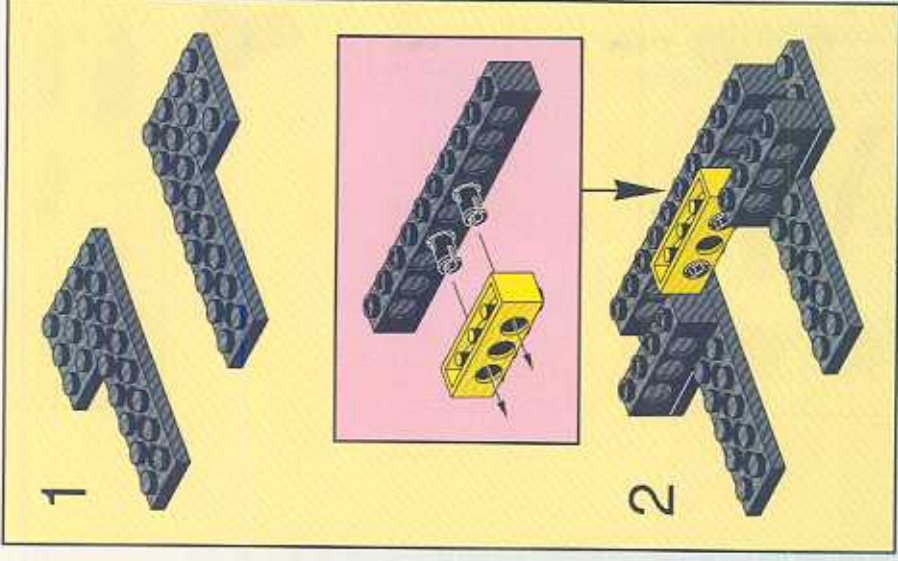



7

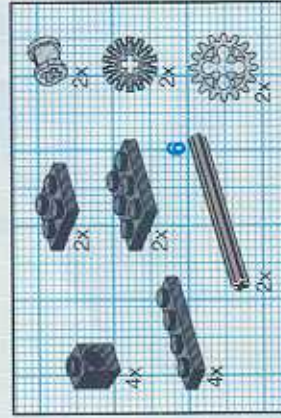
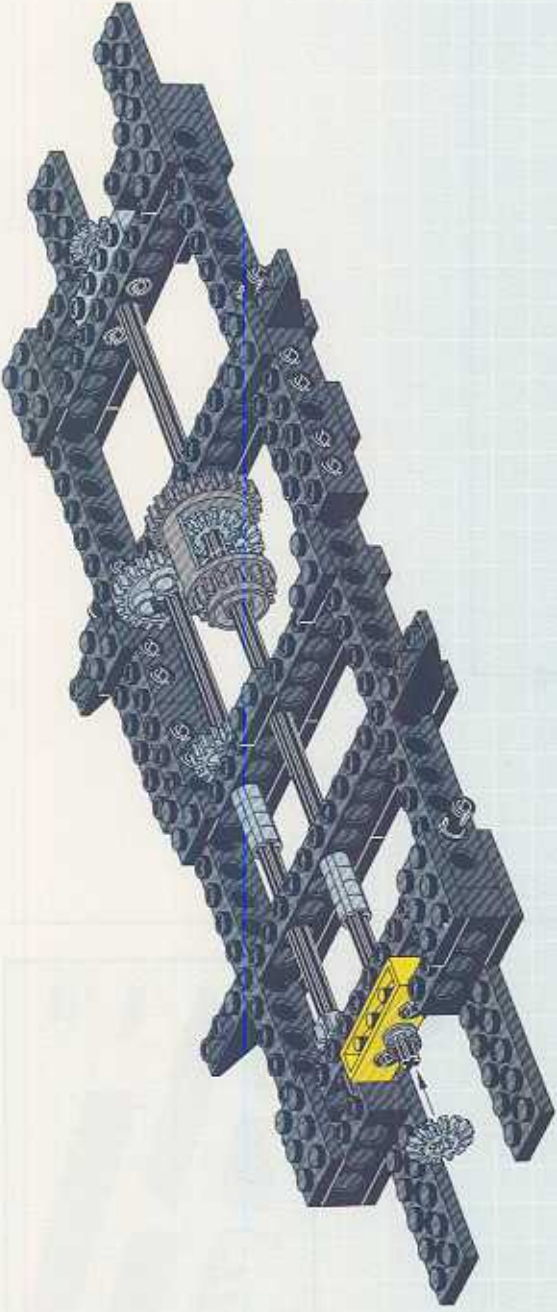

8

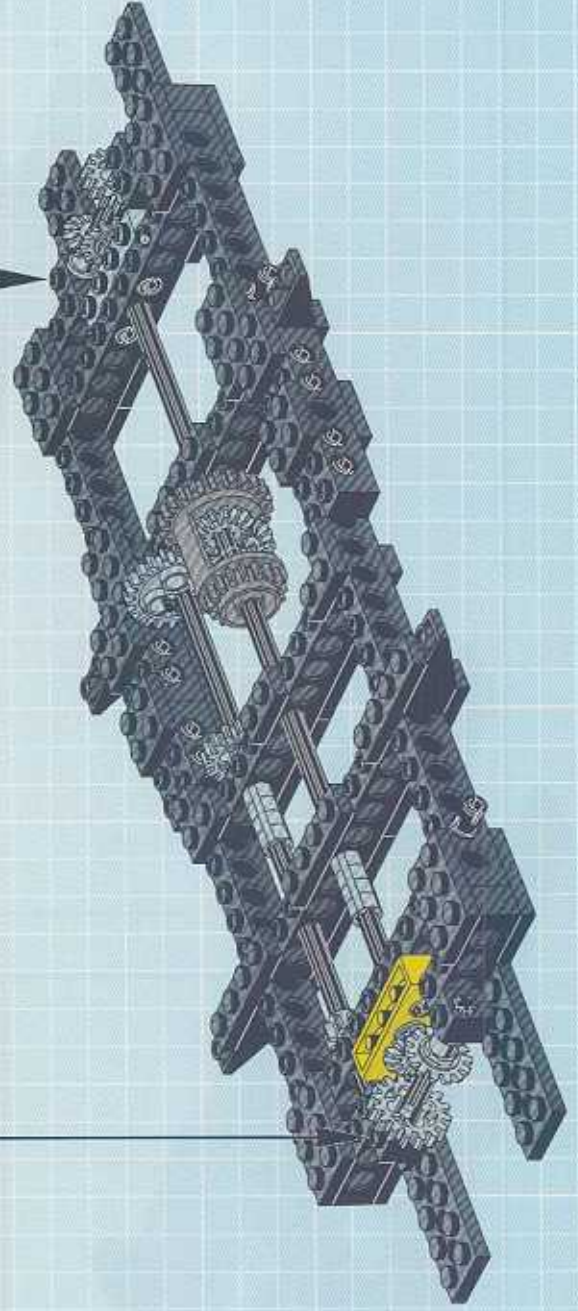
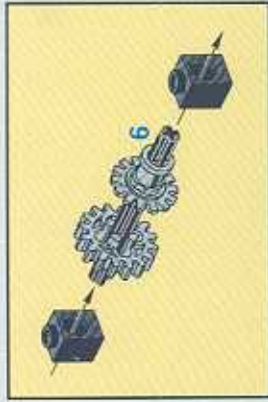

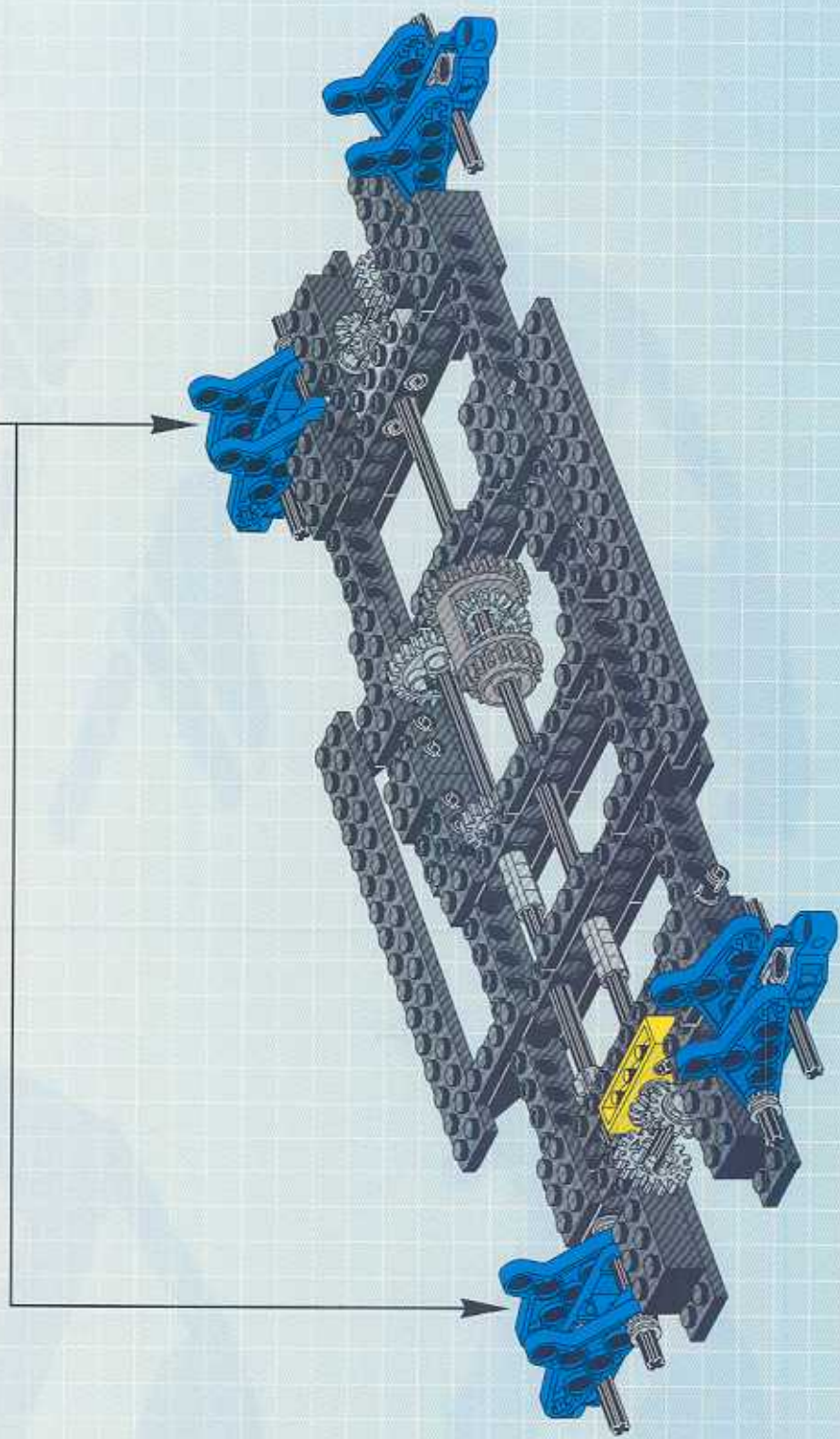
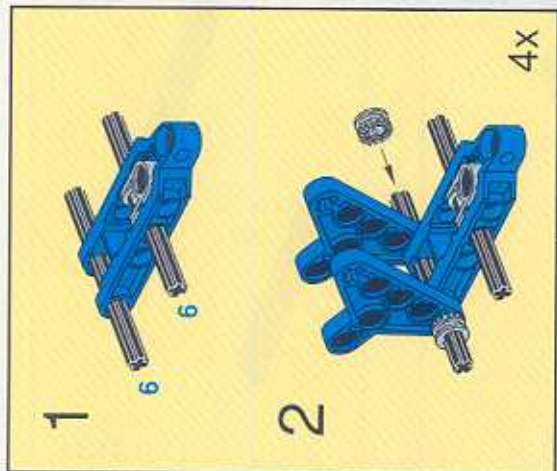

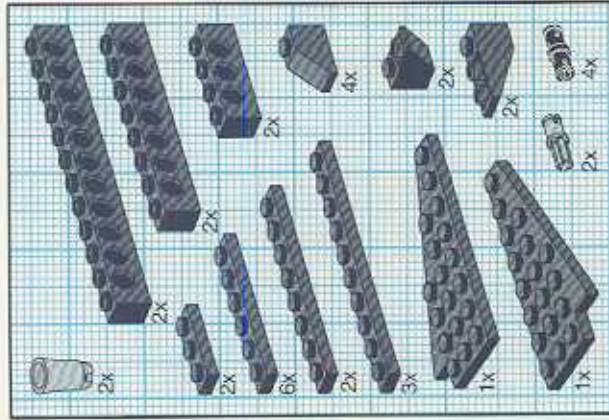

10

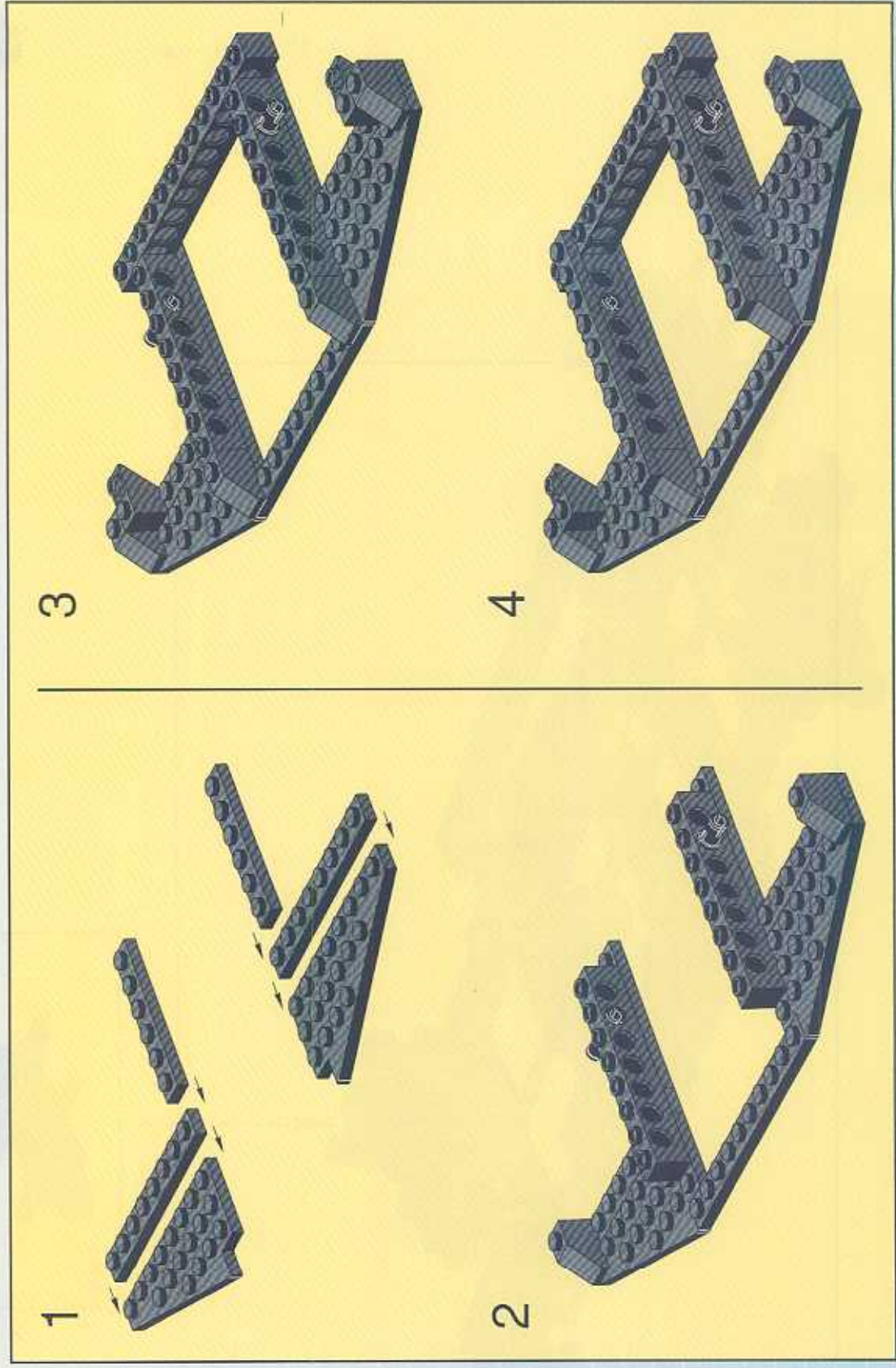

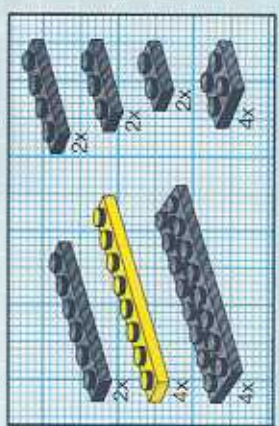
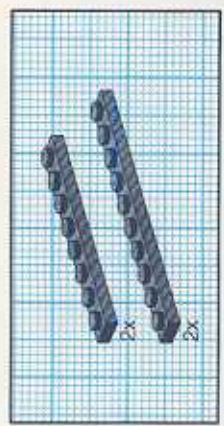
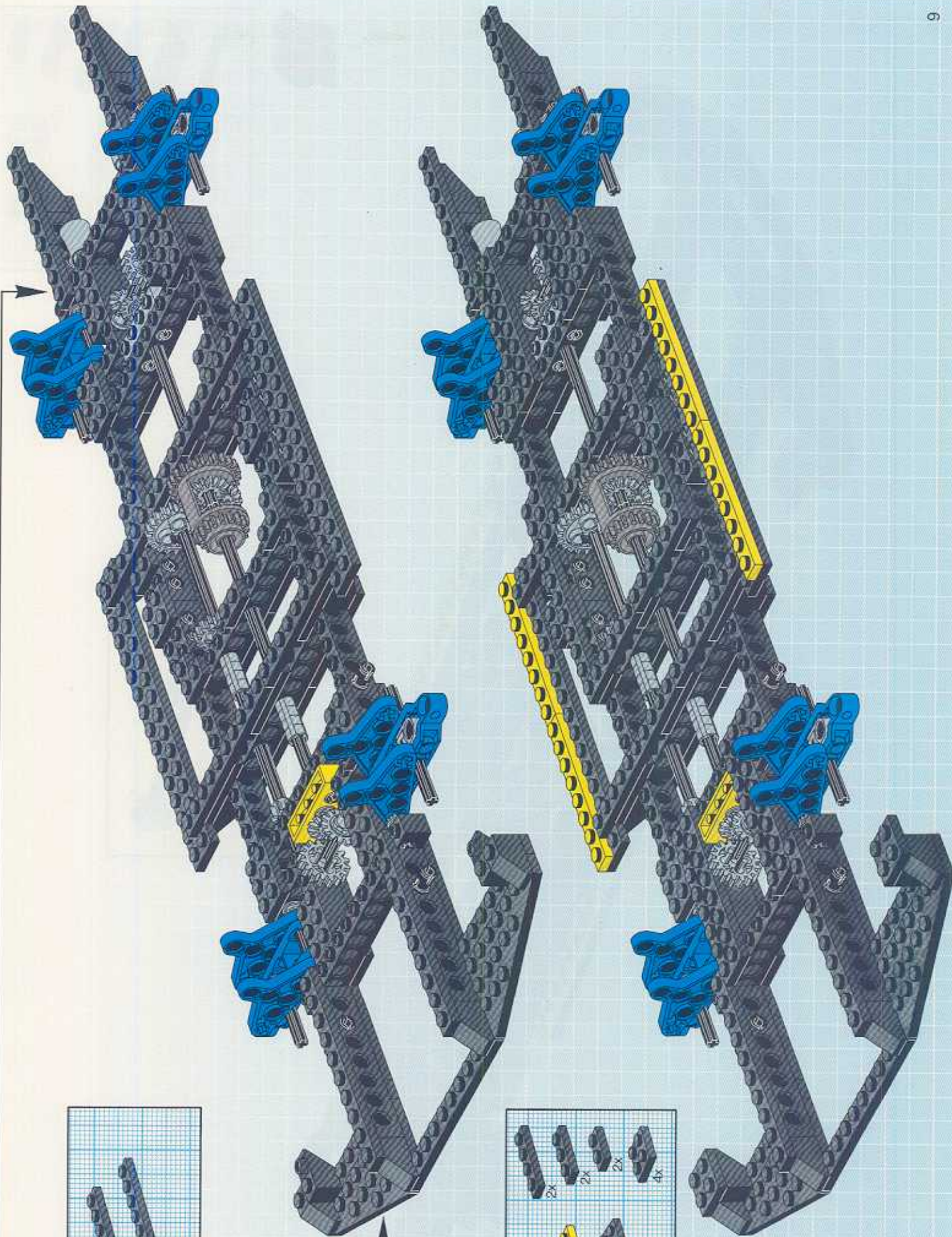

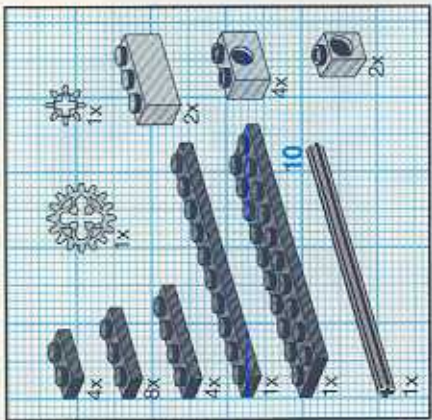

12

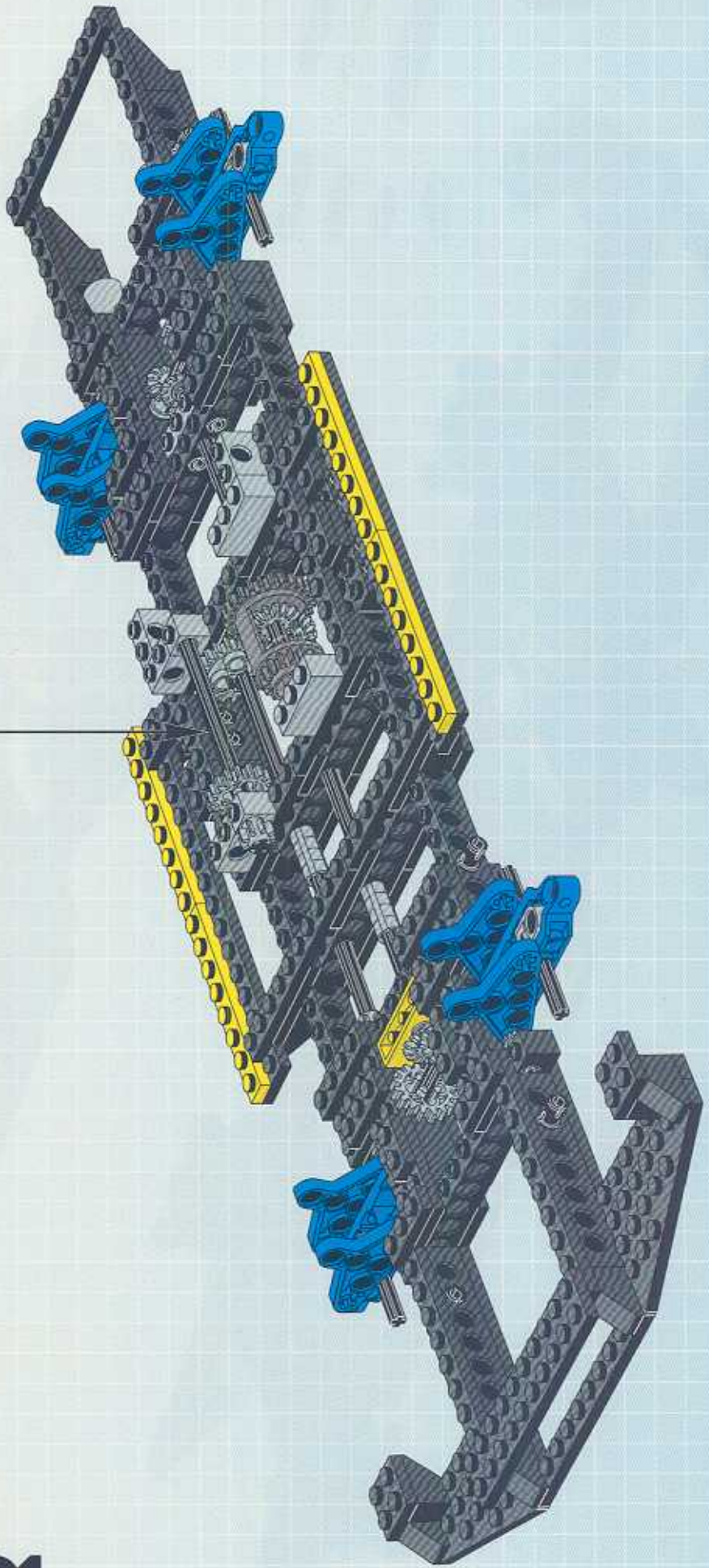
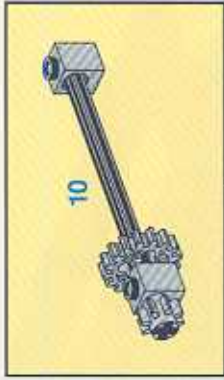

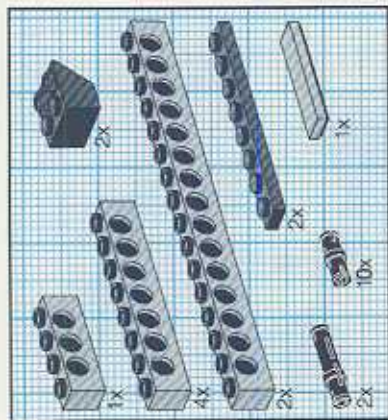

14

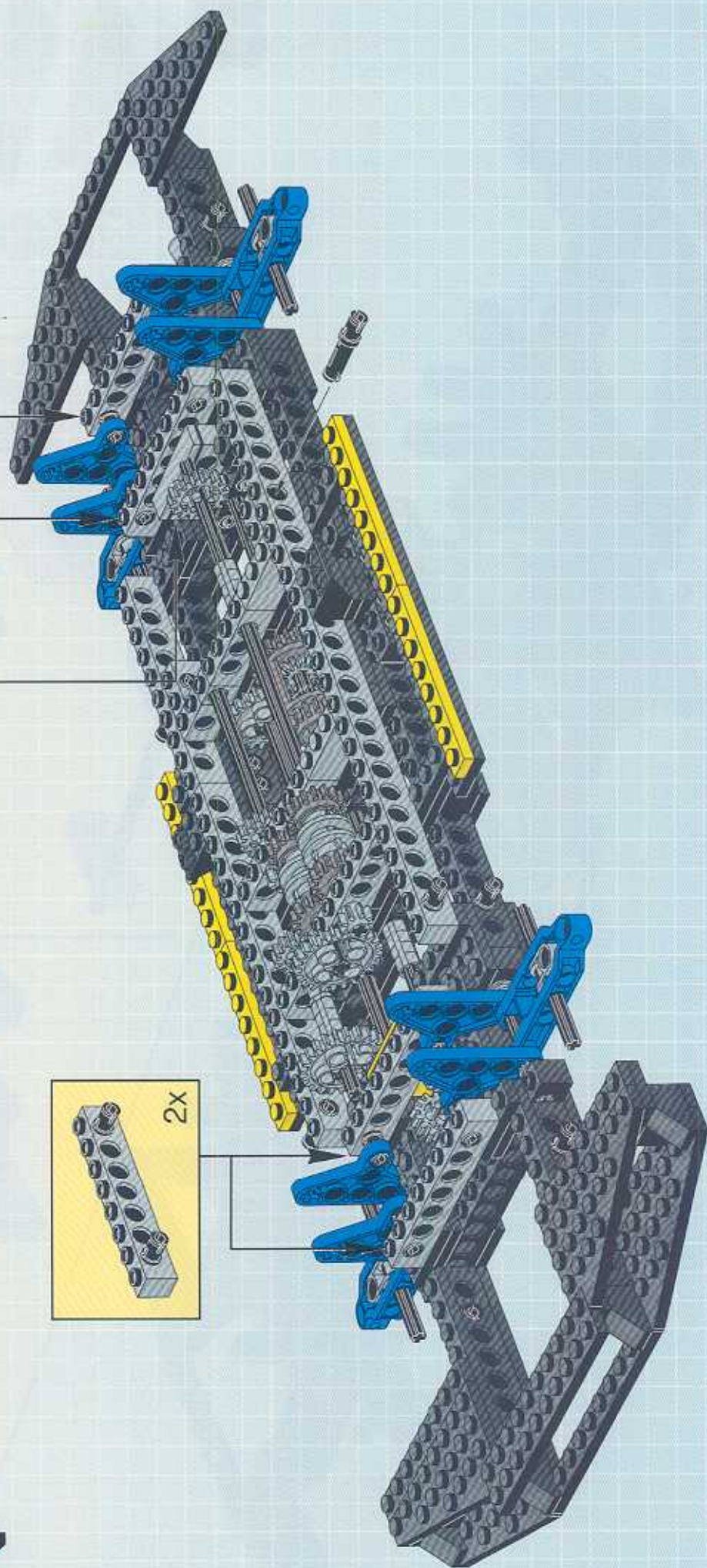
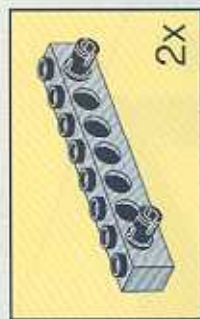
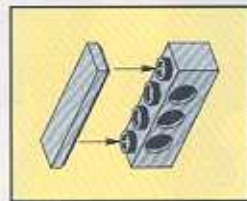
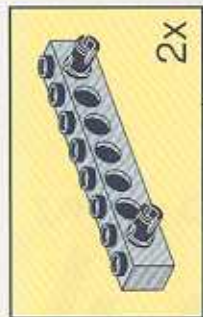

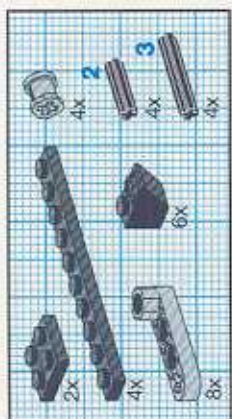

16

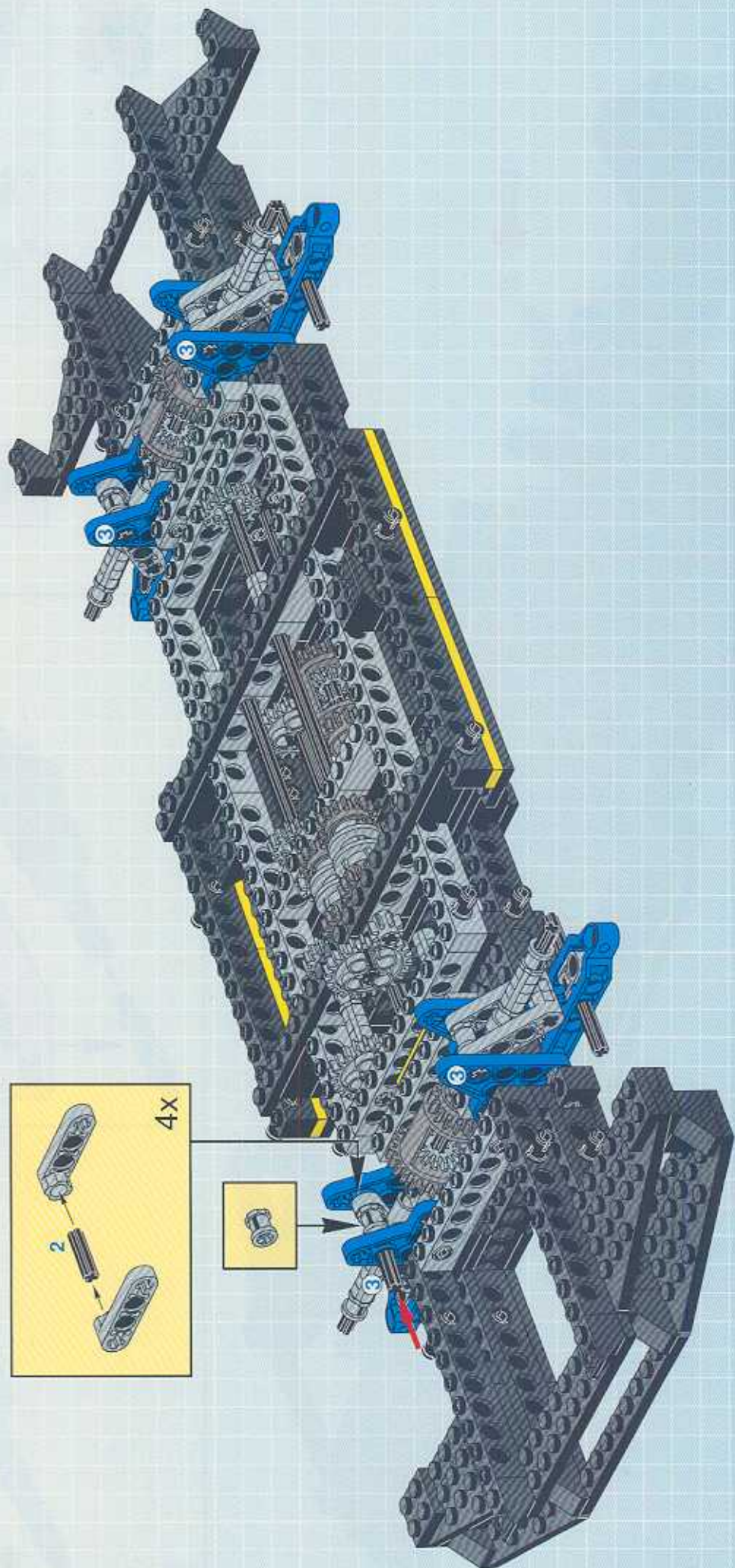

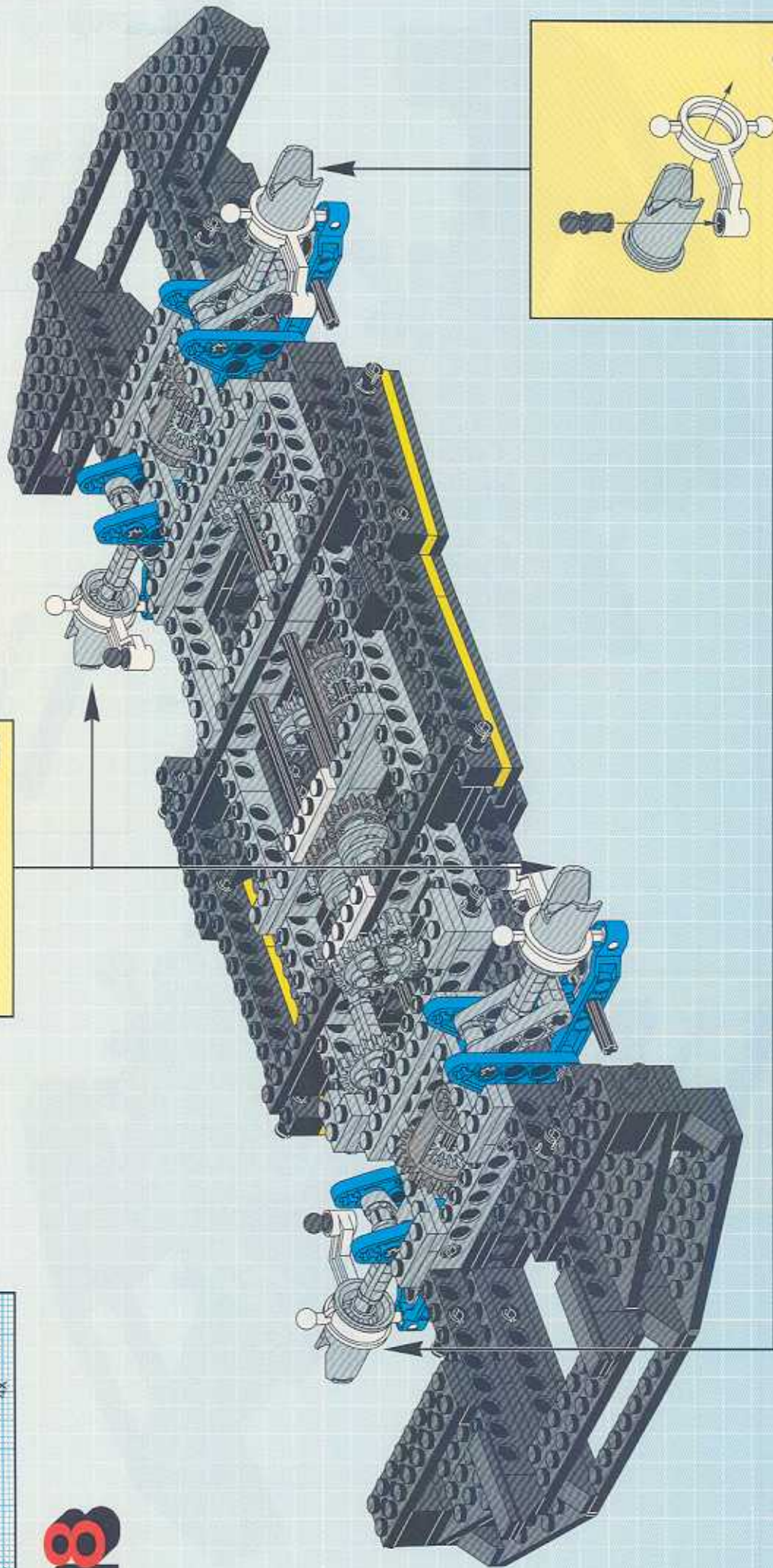
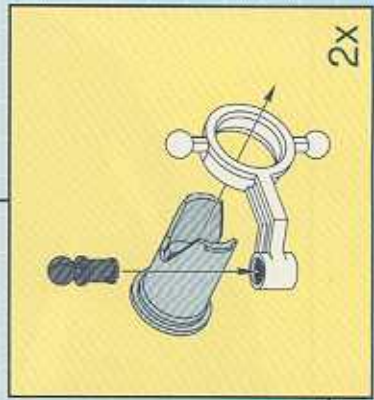
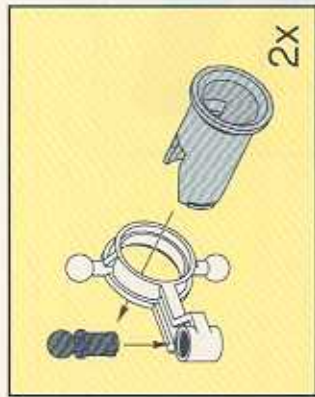
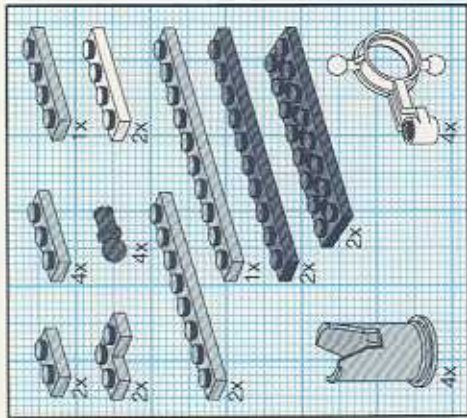

18

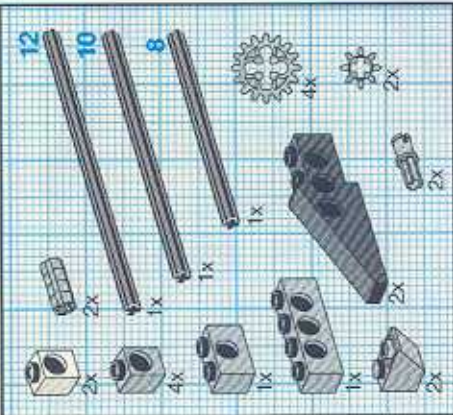
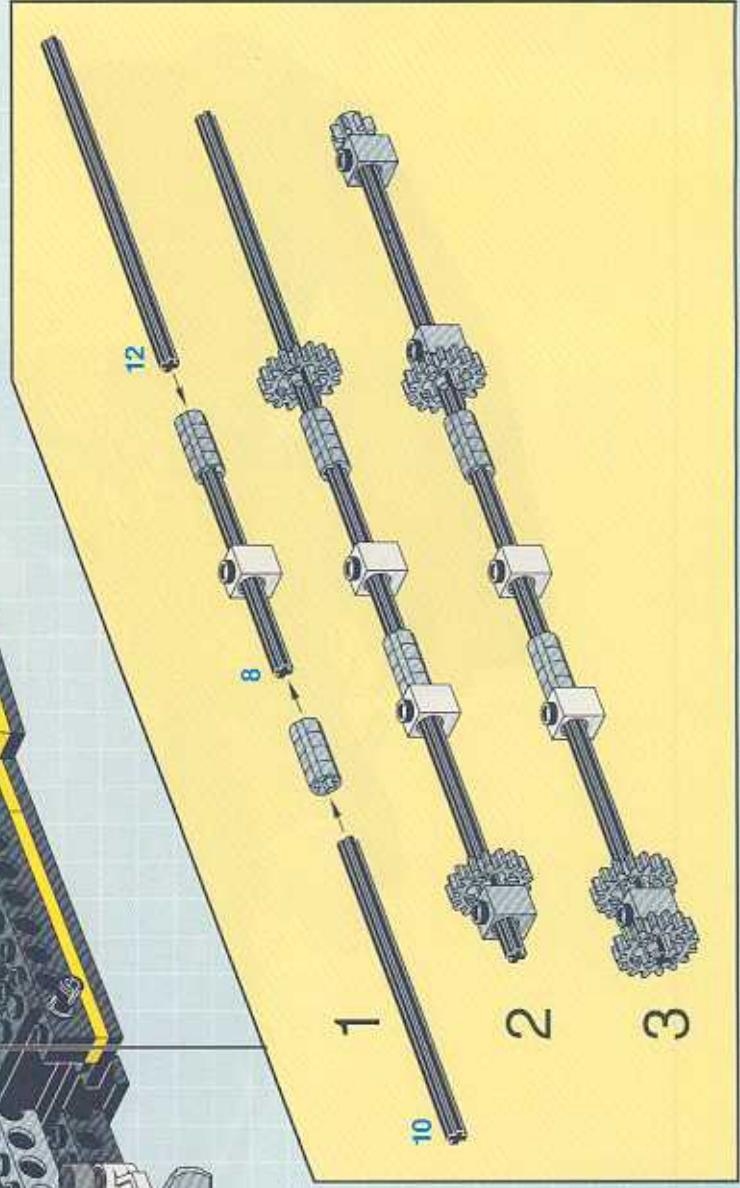
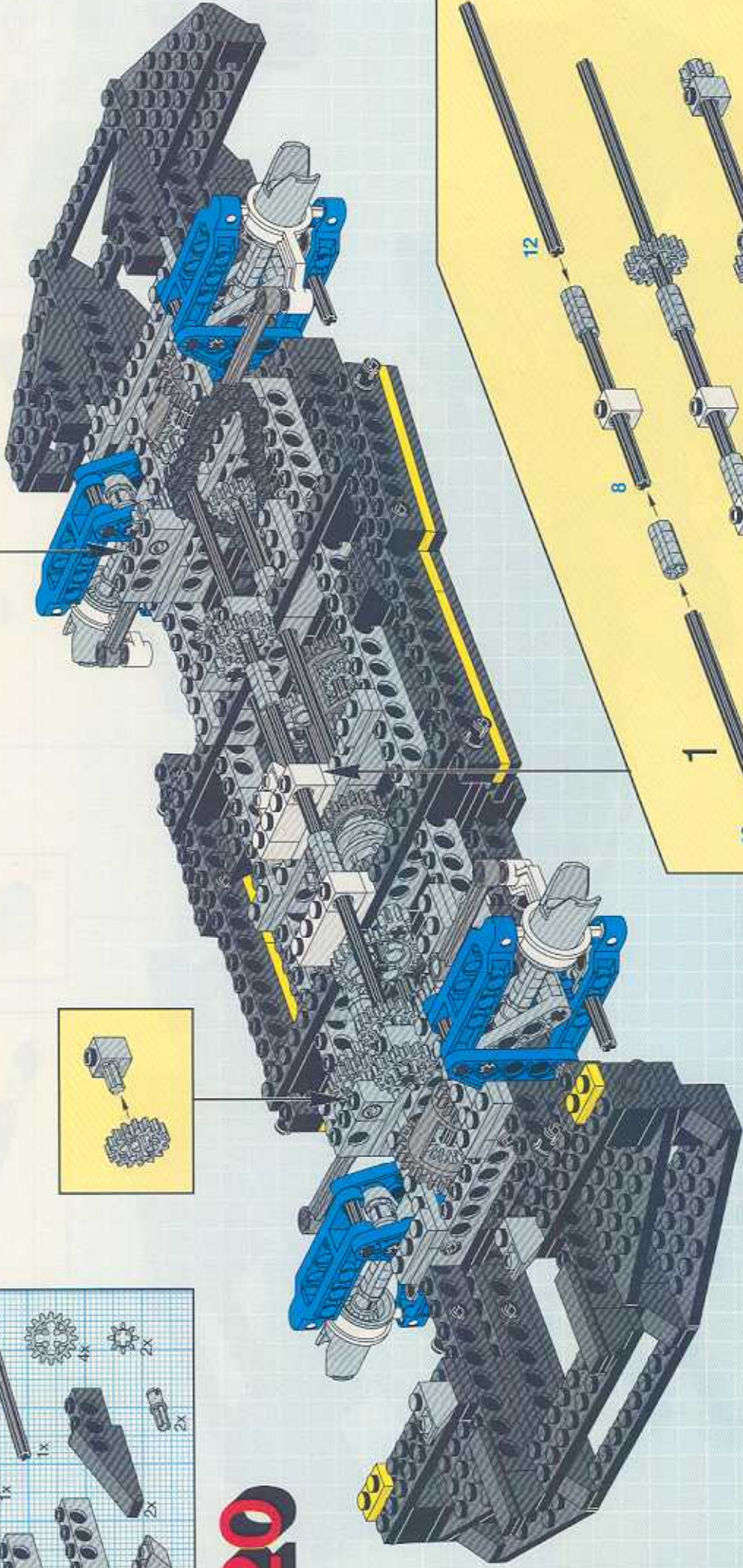
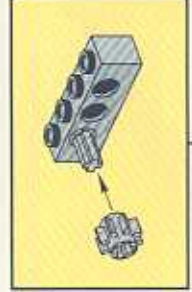

20

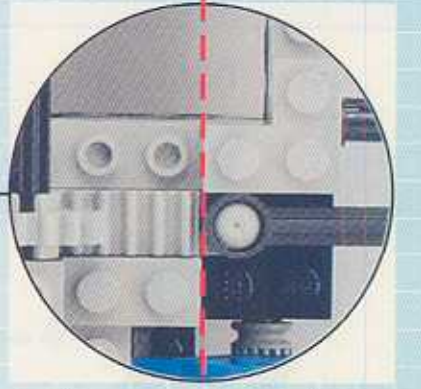
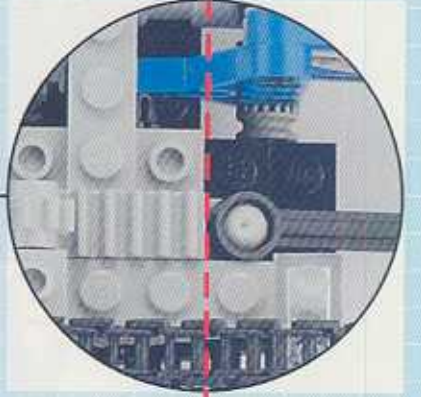
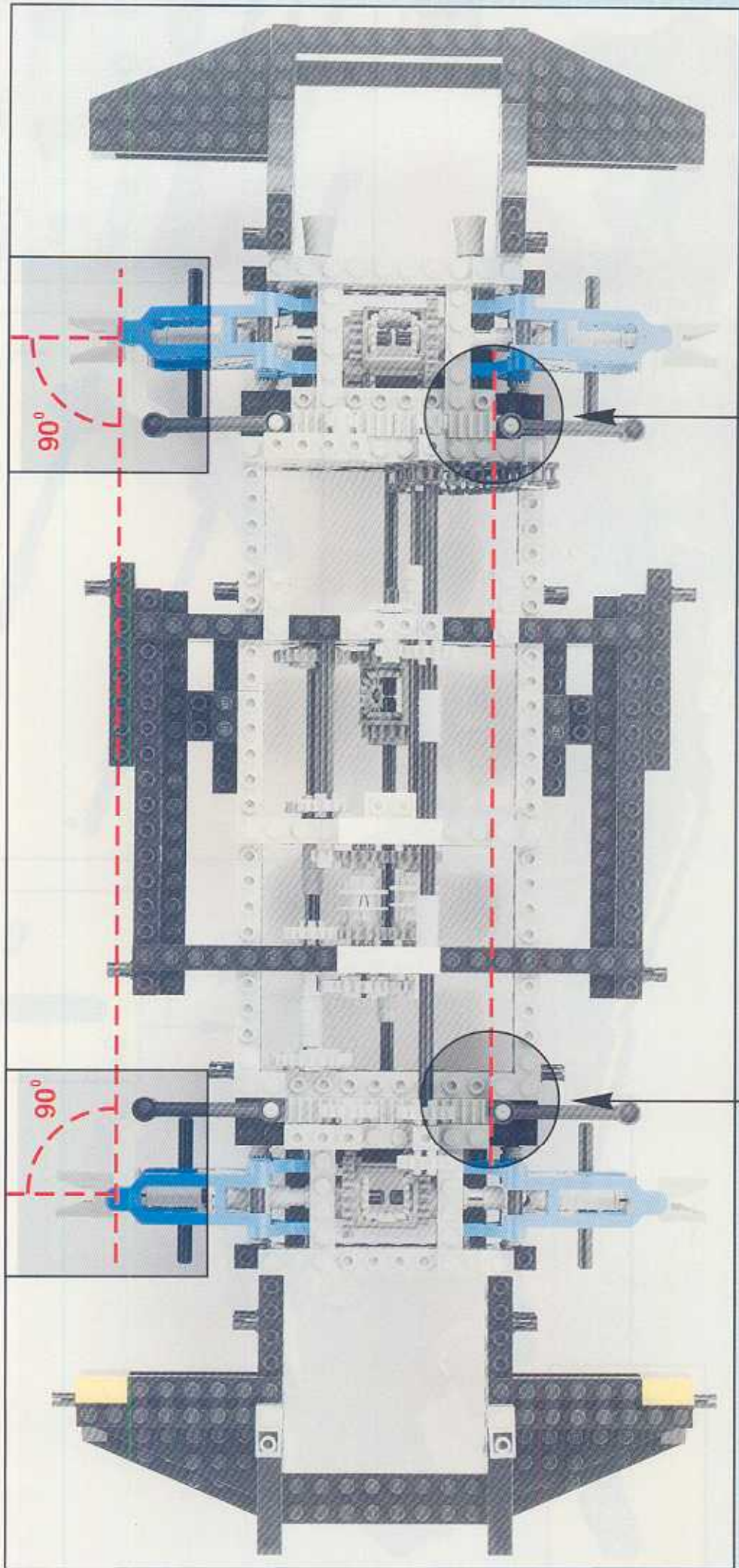

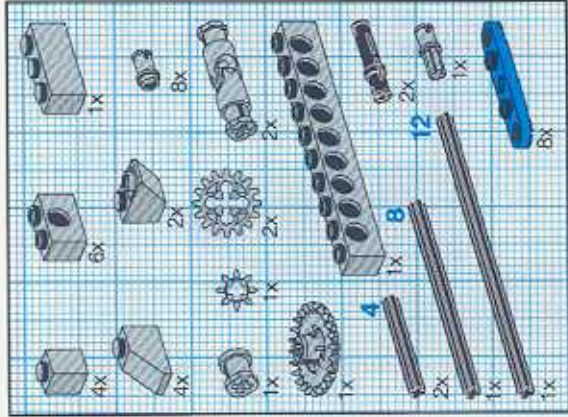

21

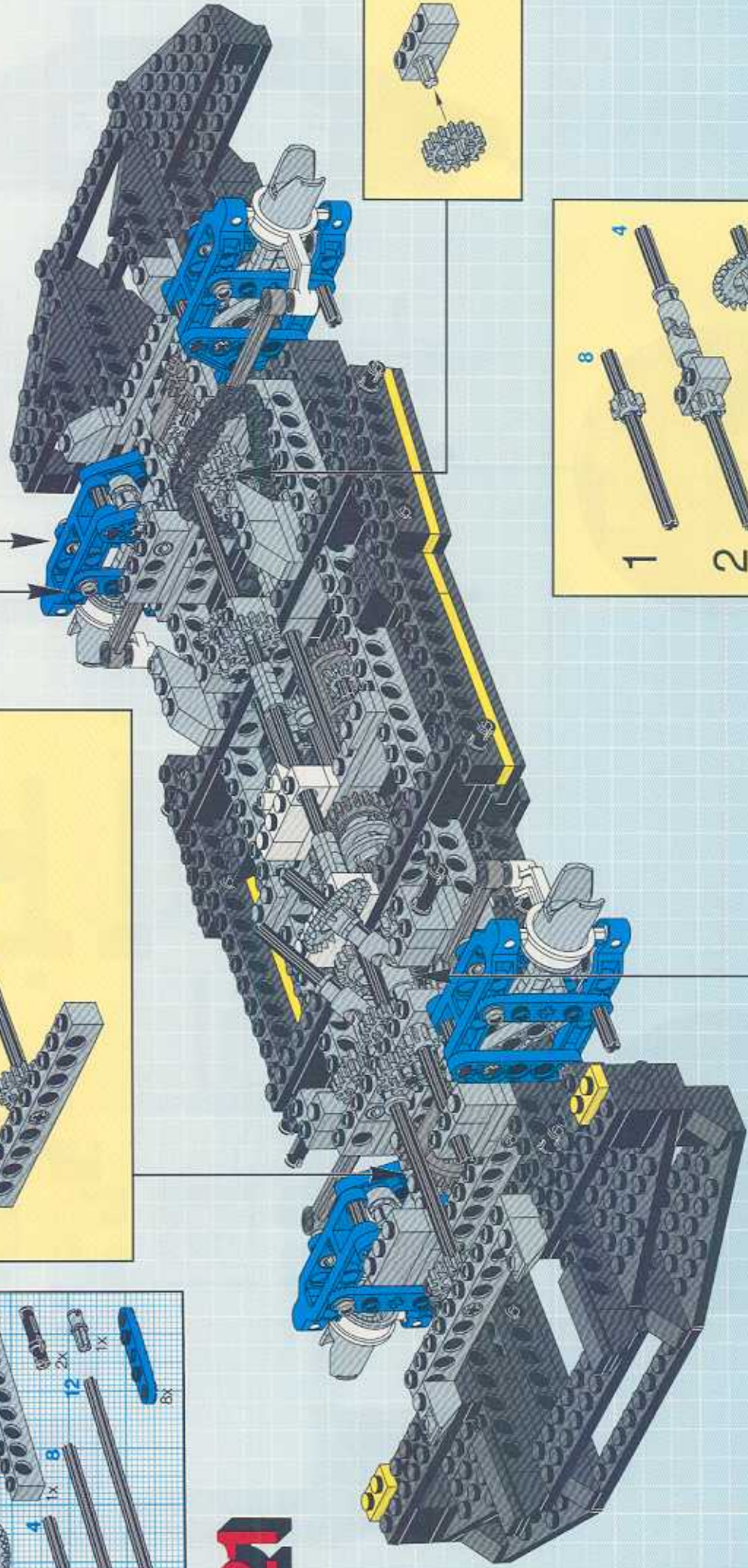
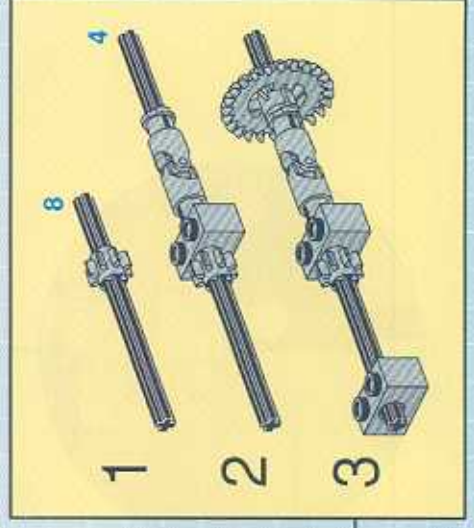
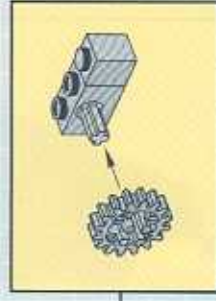
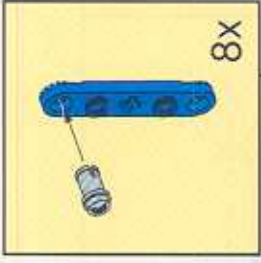
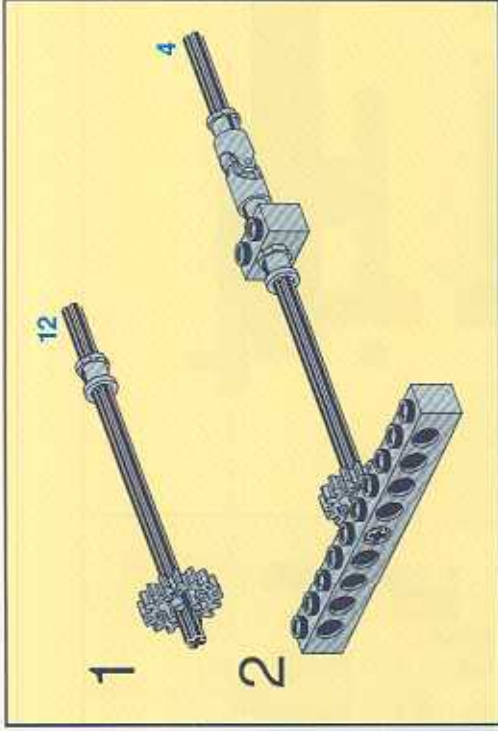

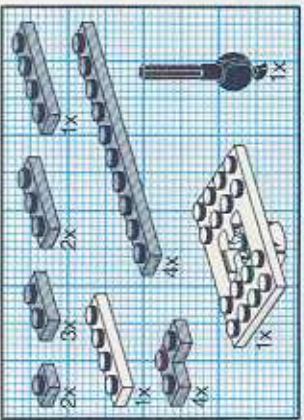
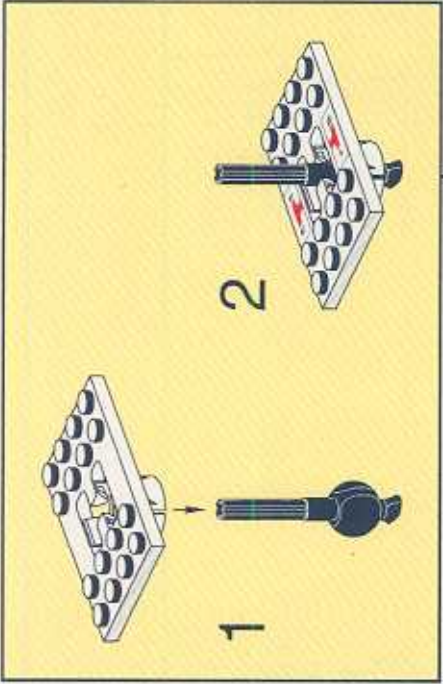
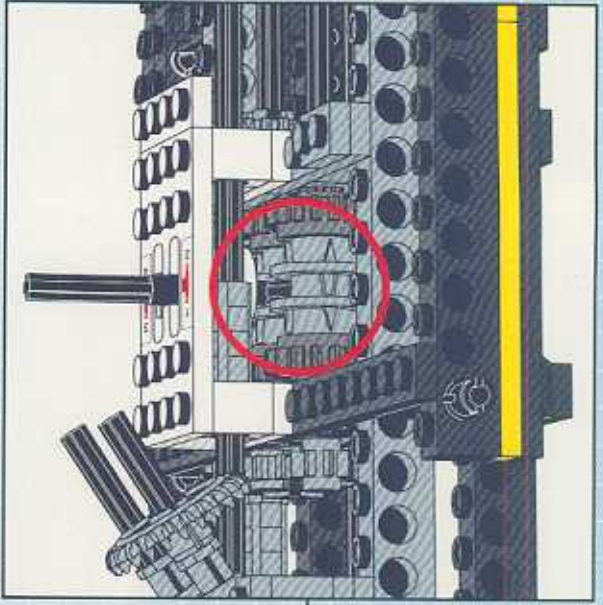
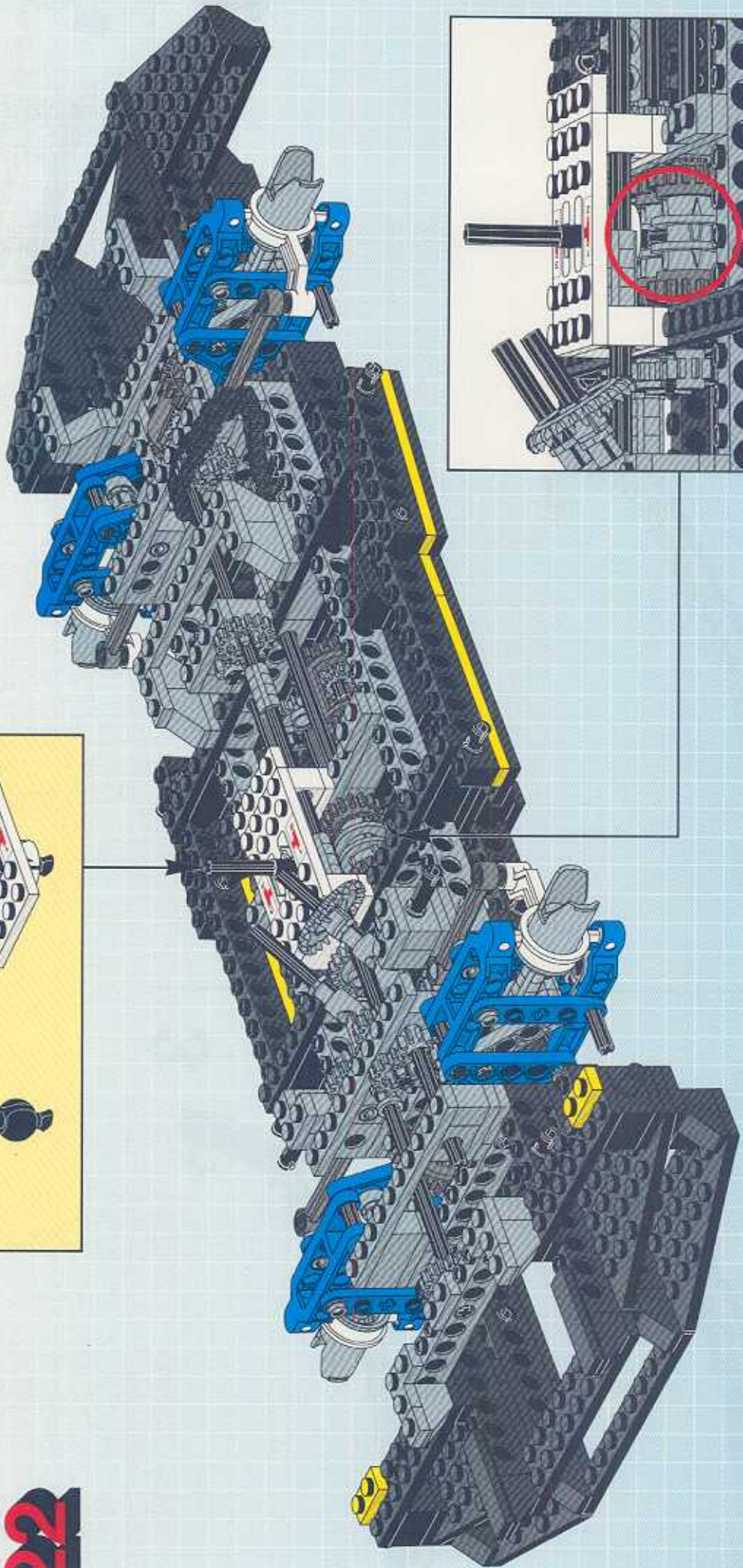

22

3



4

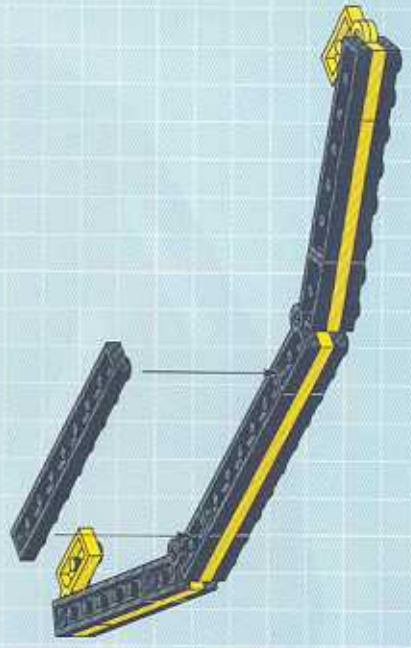

1

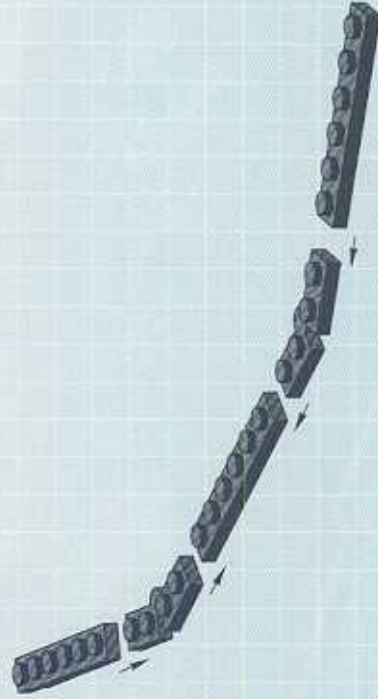

2

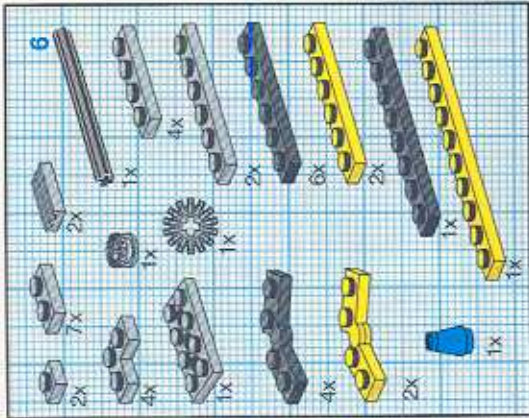
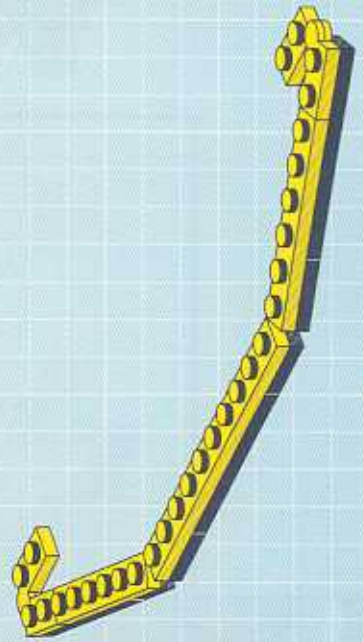

23

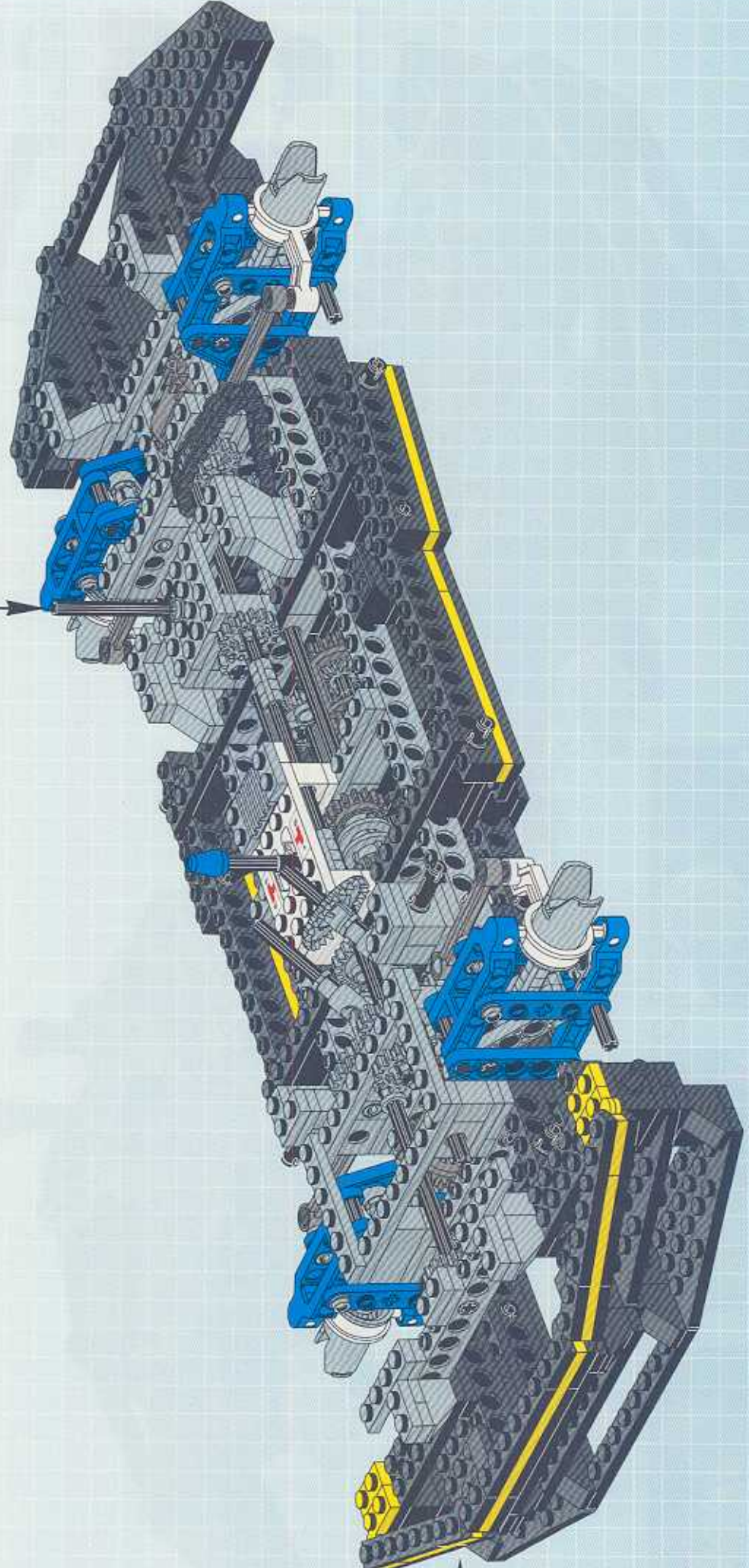
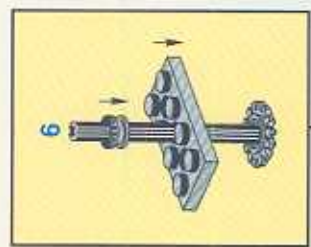

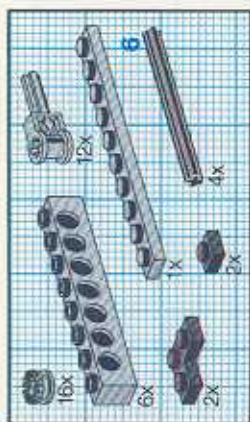
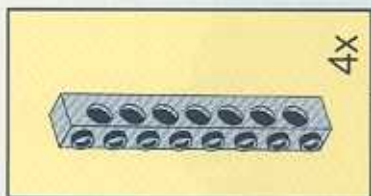
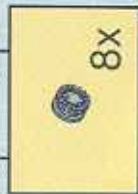
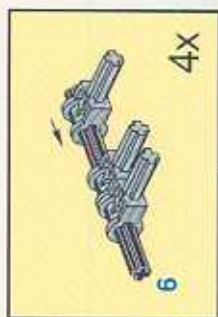
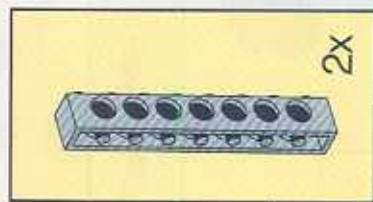

25

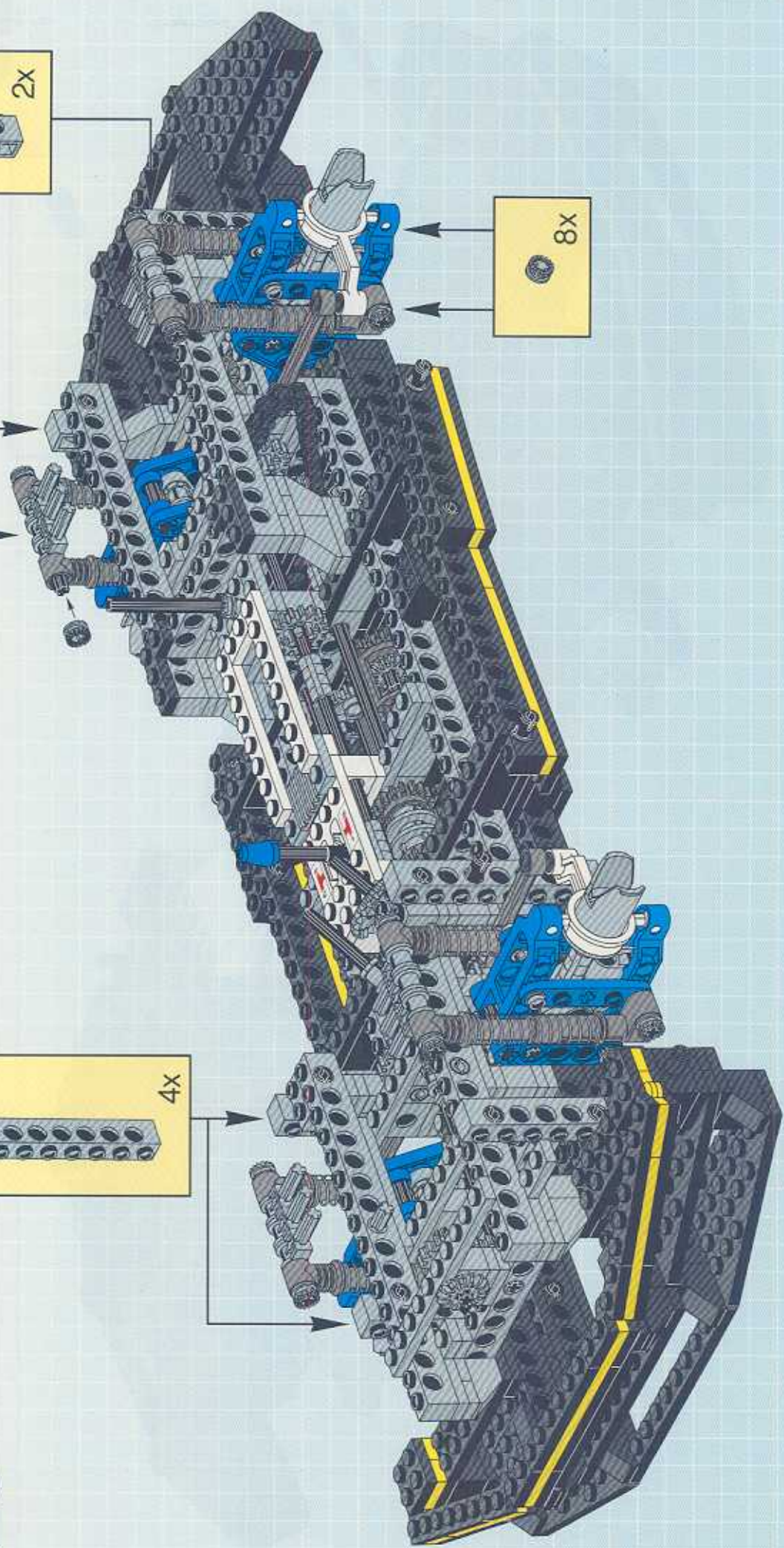

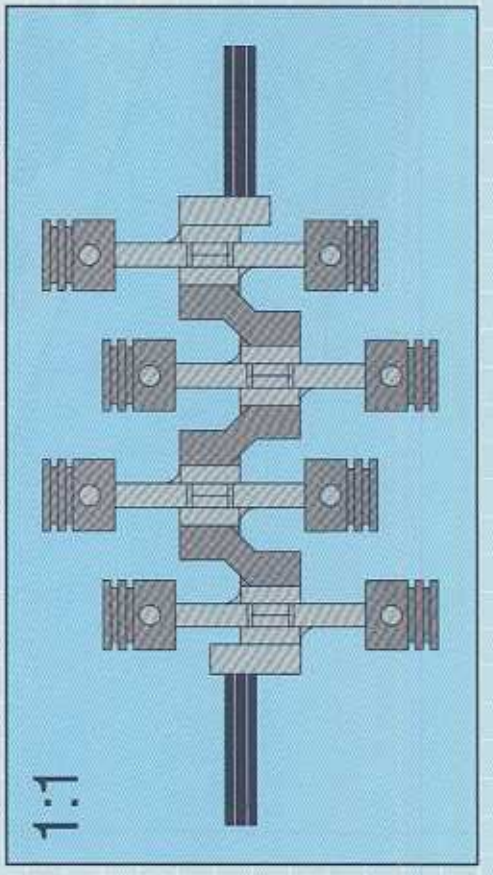
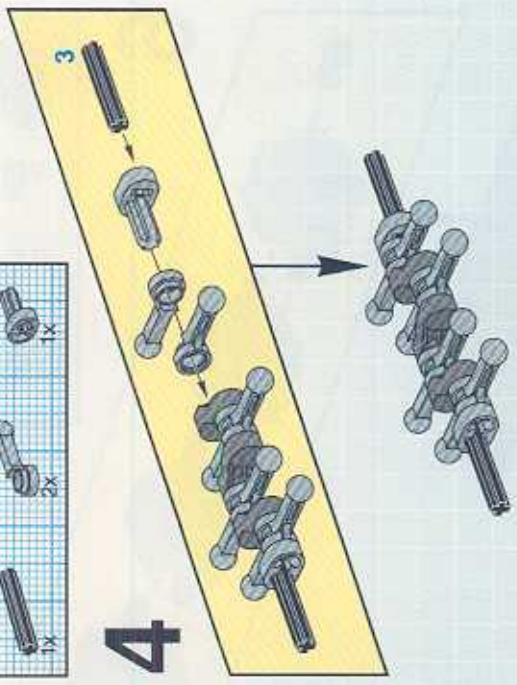
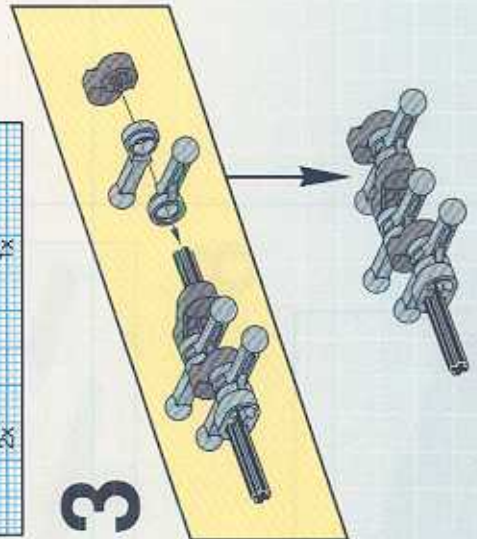
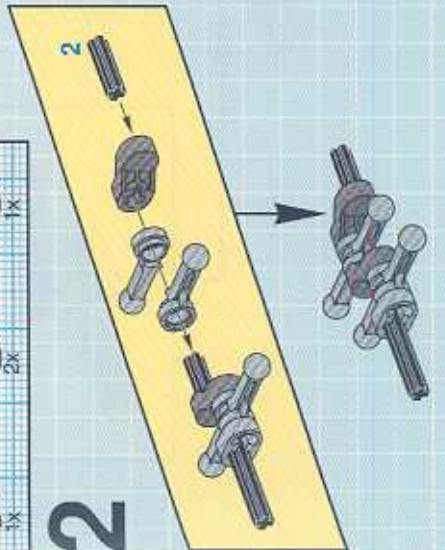
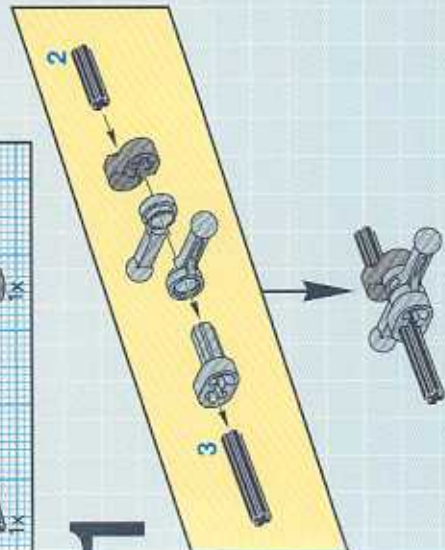
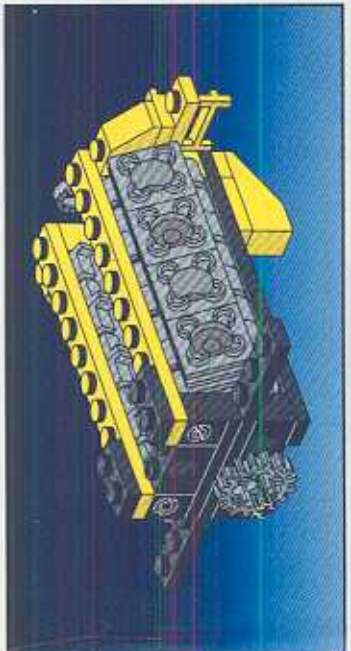

1:1

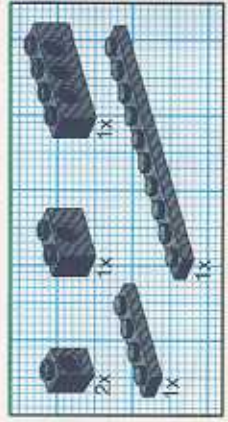

8

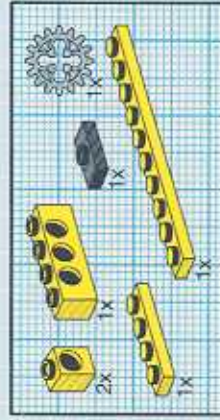
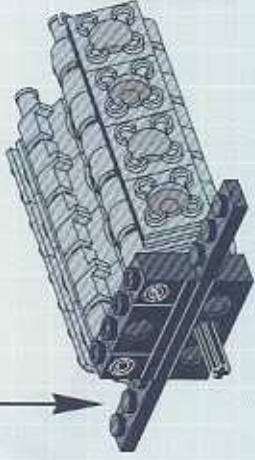
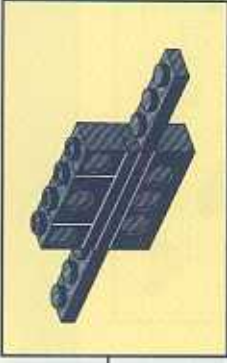

9

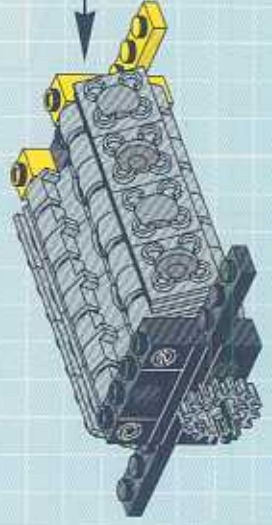
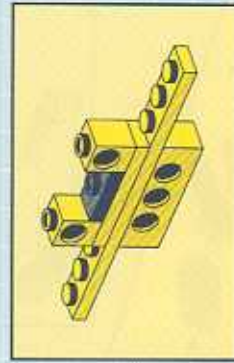

6

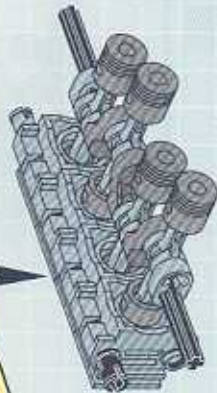
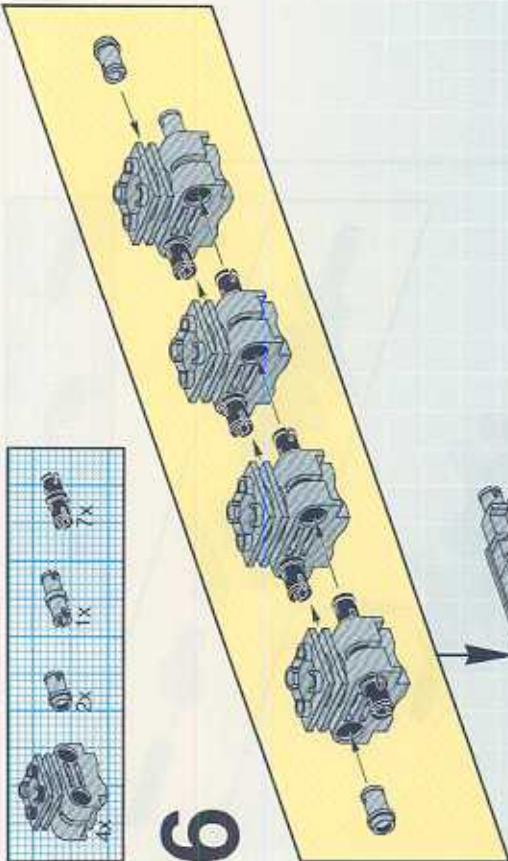

7

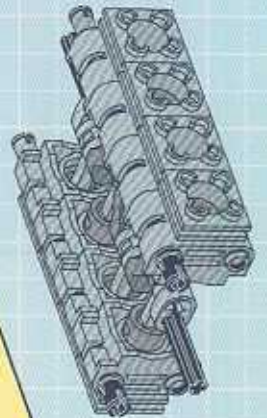
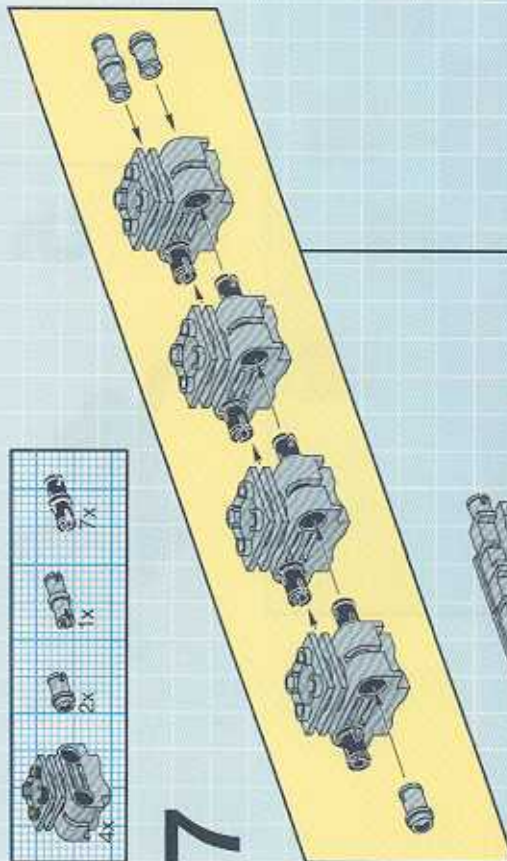

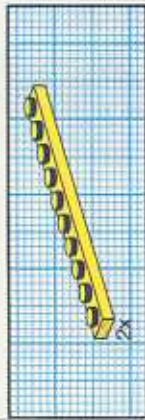

10

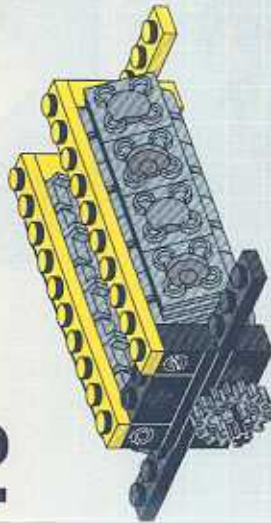

12

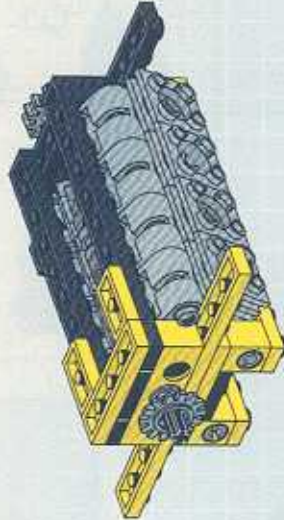

11

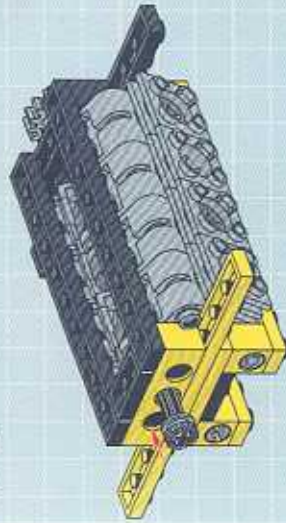

13

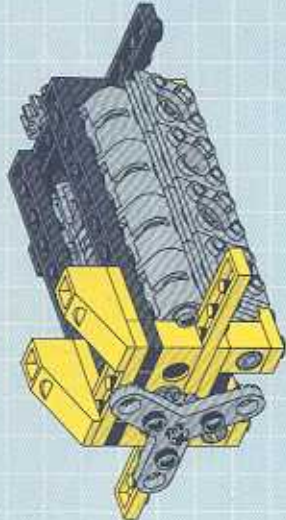

14

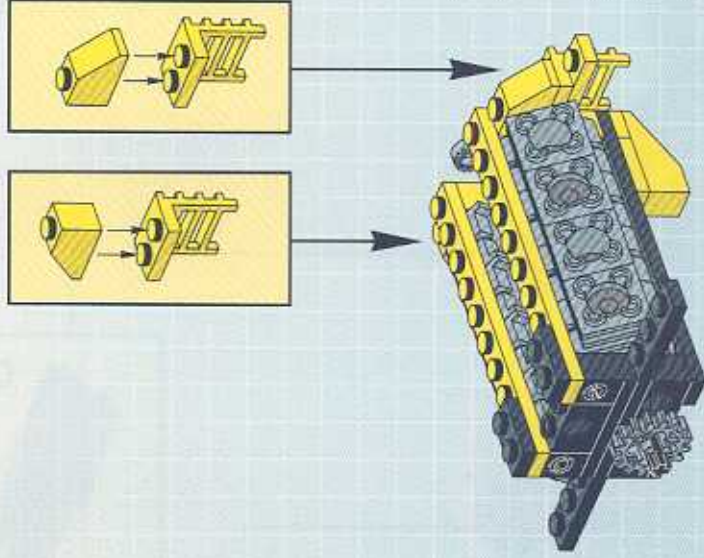

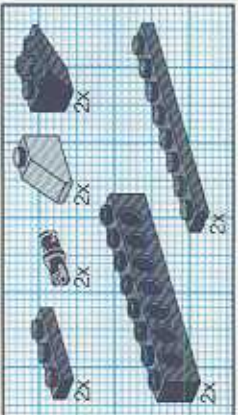
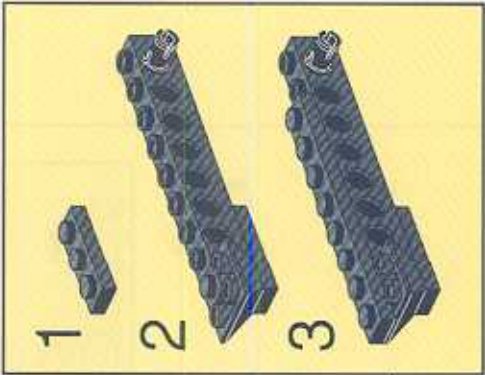
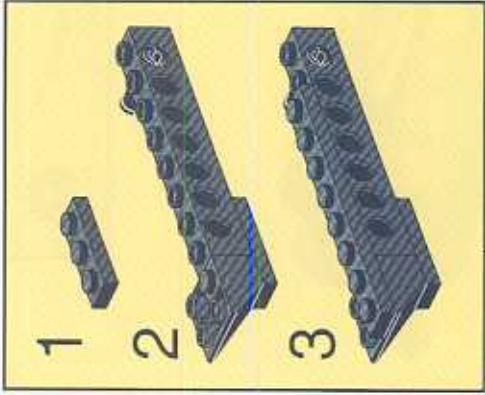
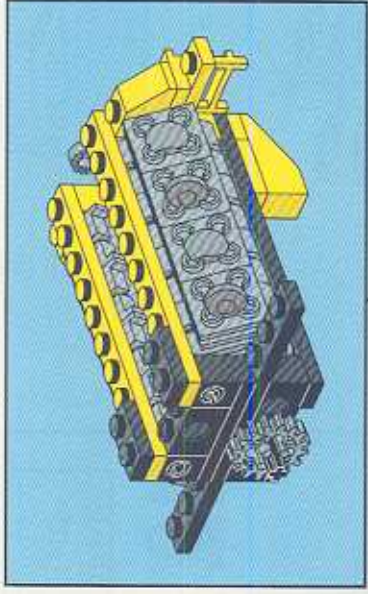

27

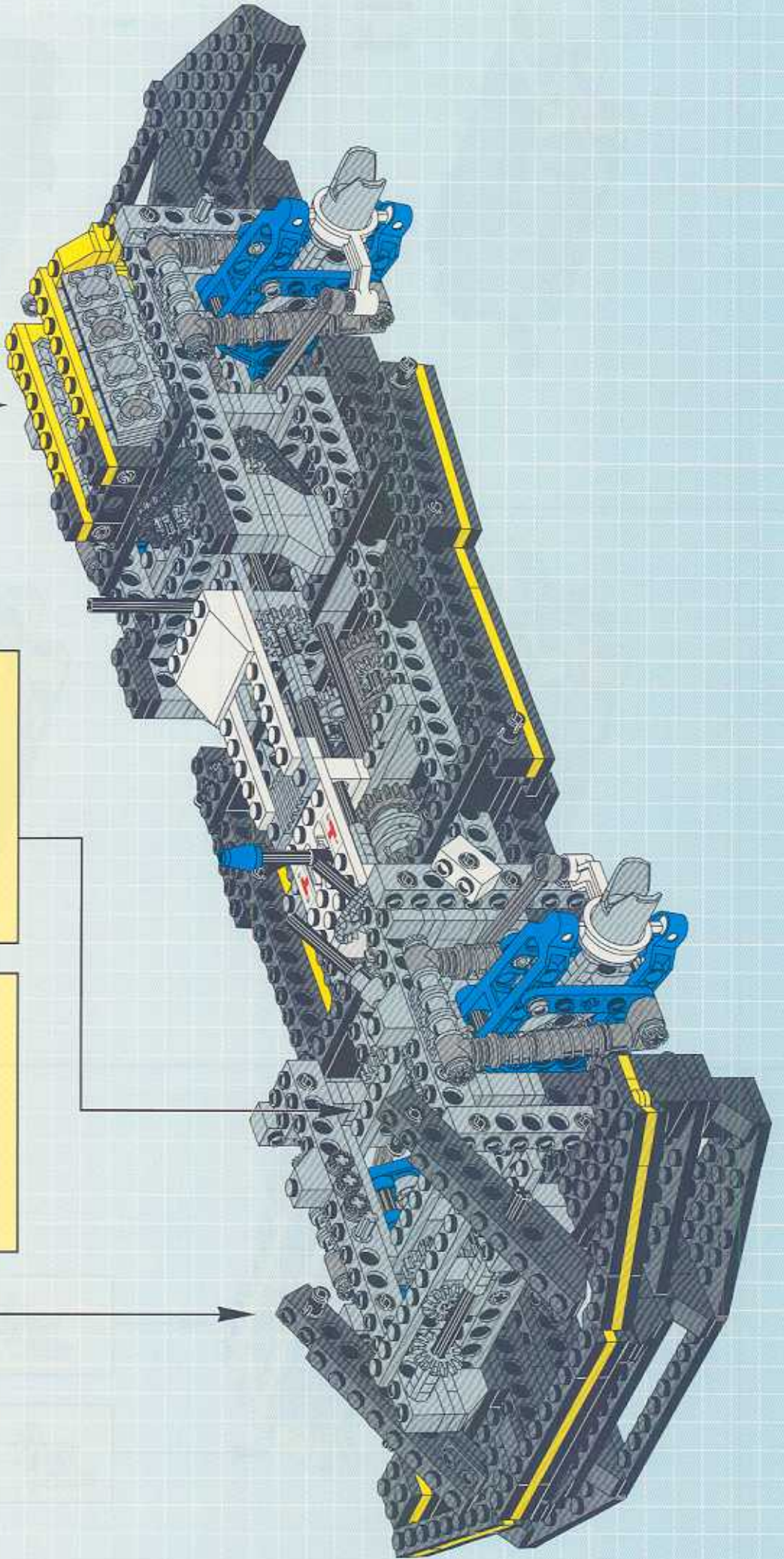

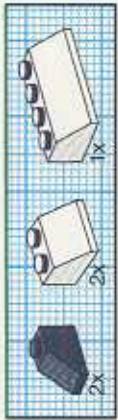

6

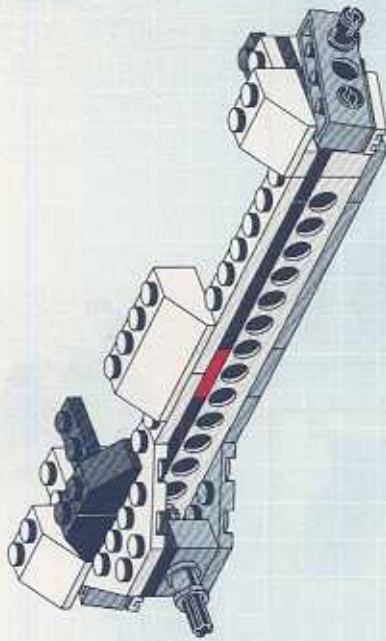

8

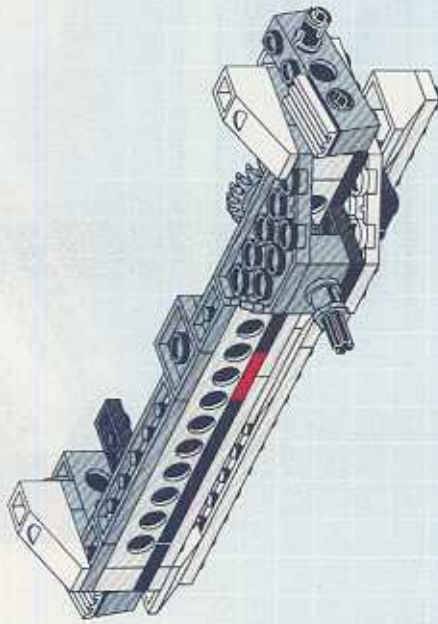

7

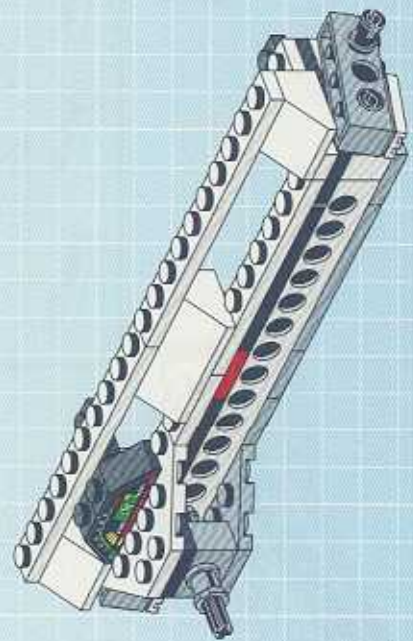

9

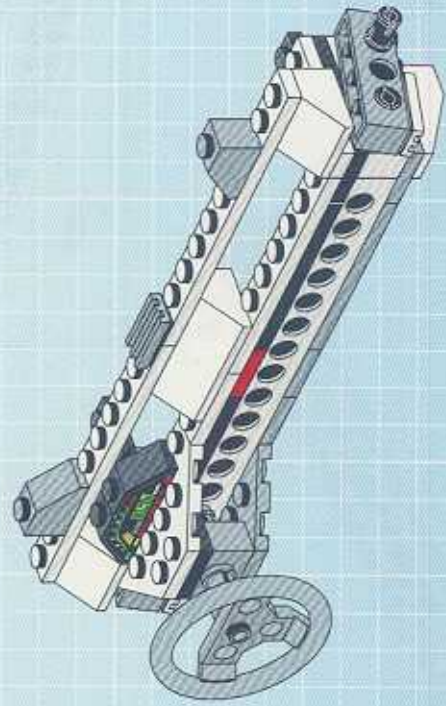

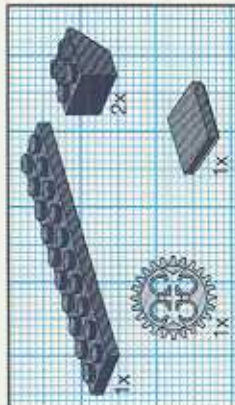
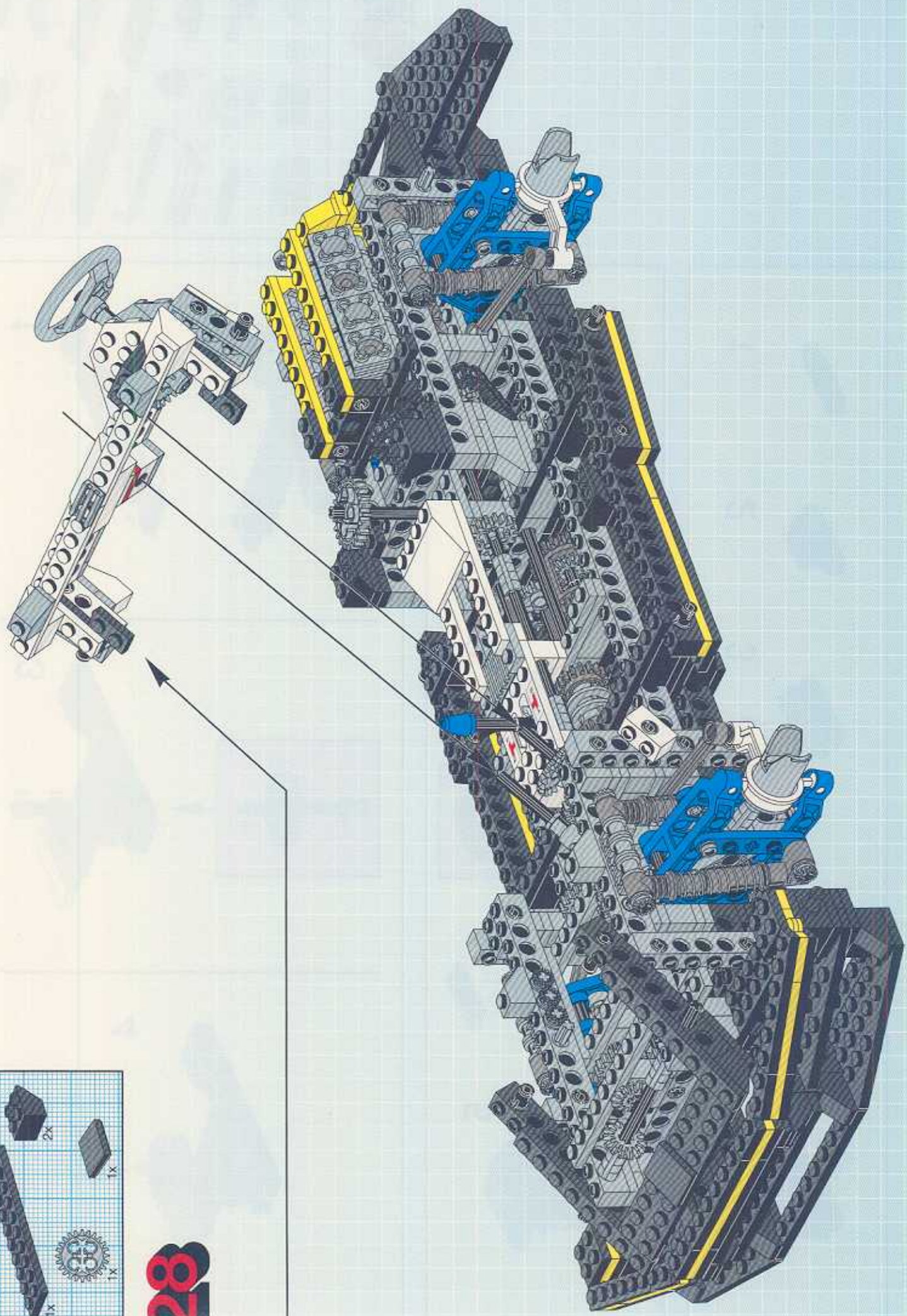

28

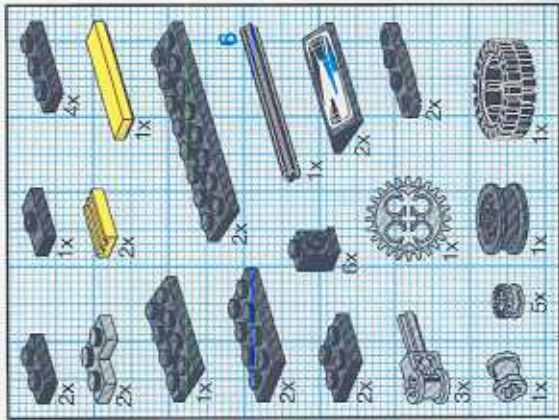

29

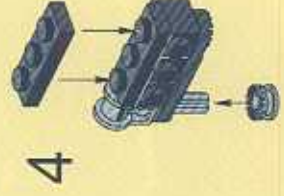
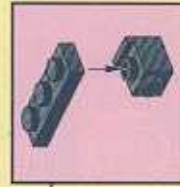
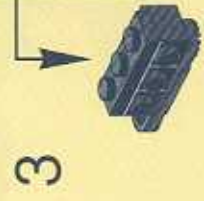
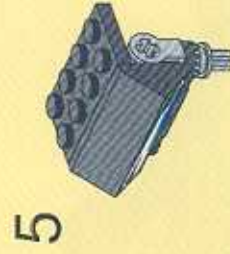
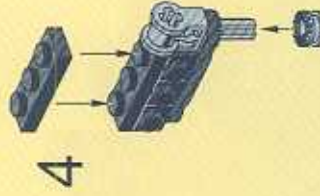
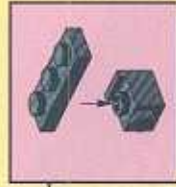
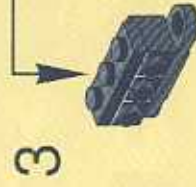
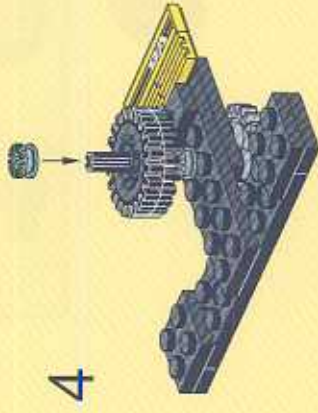
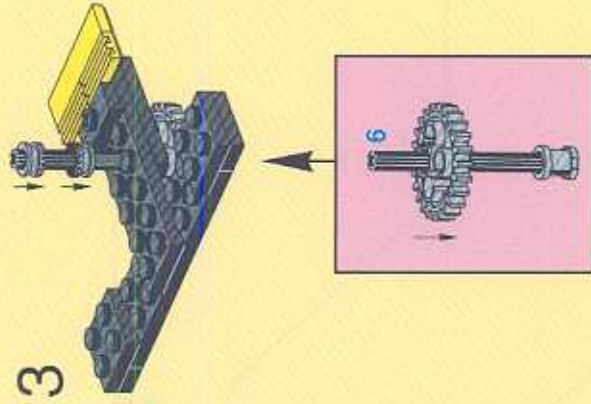
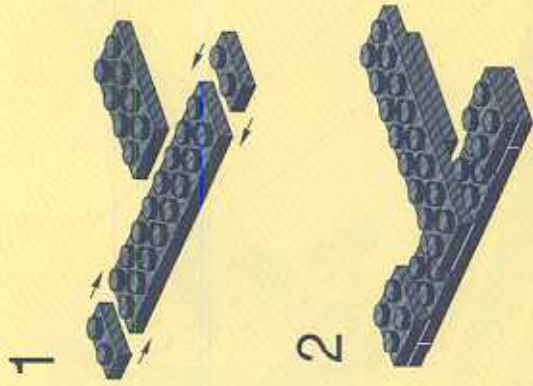

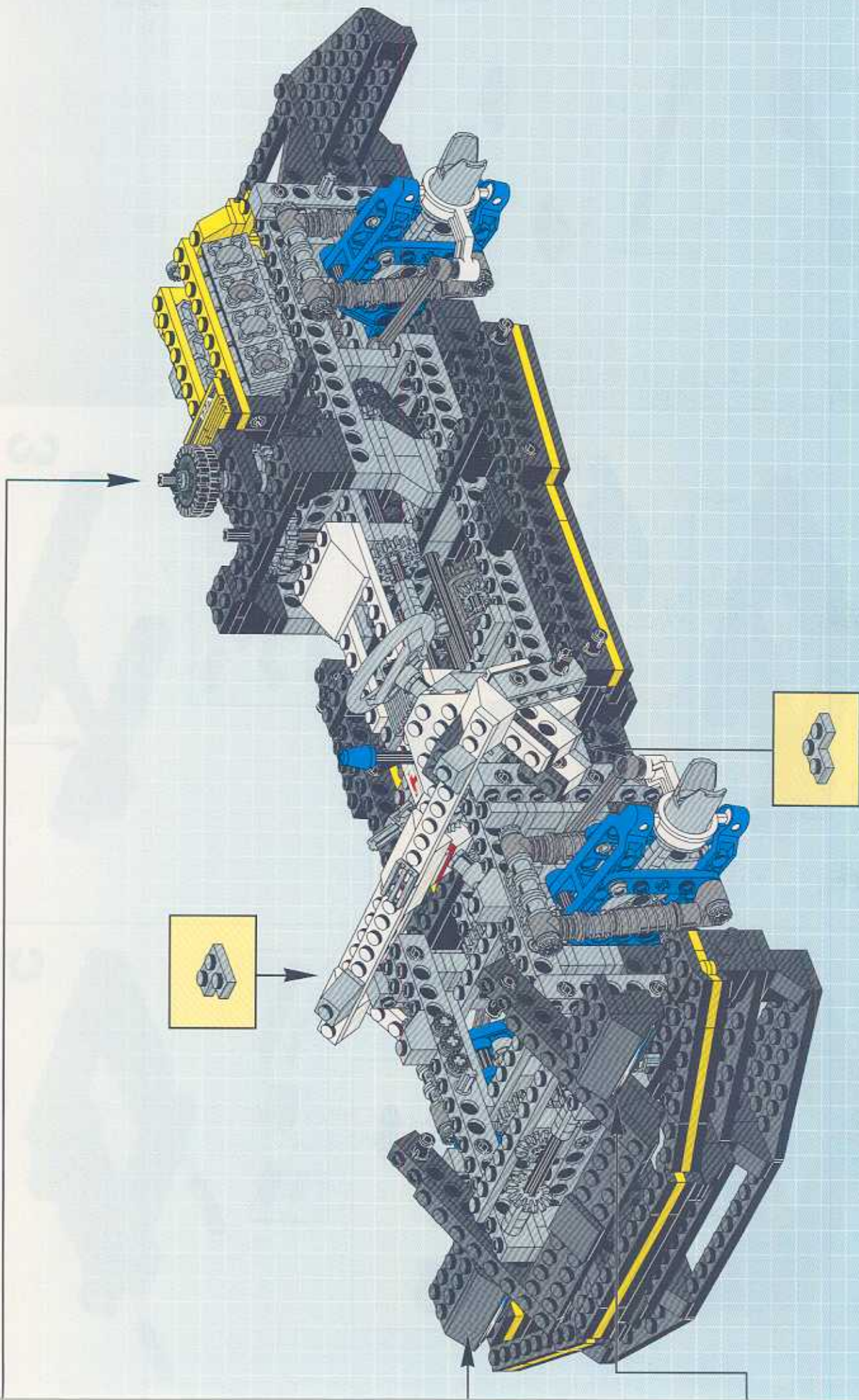

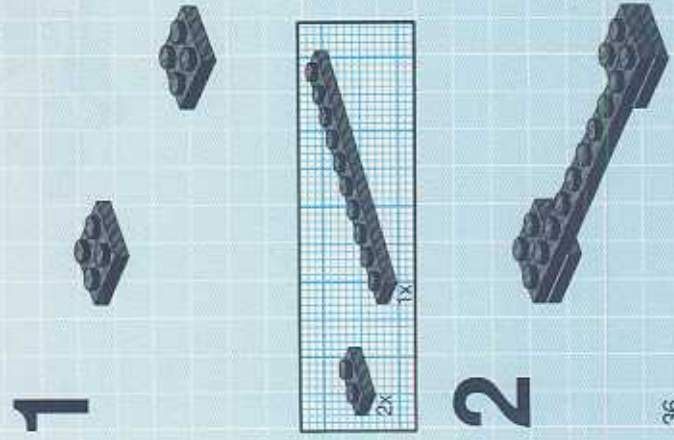
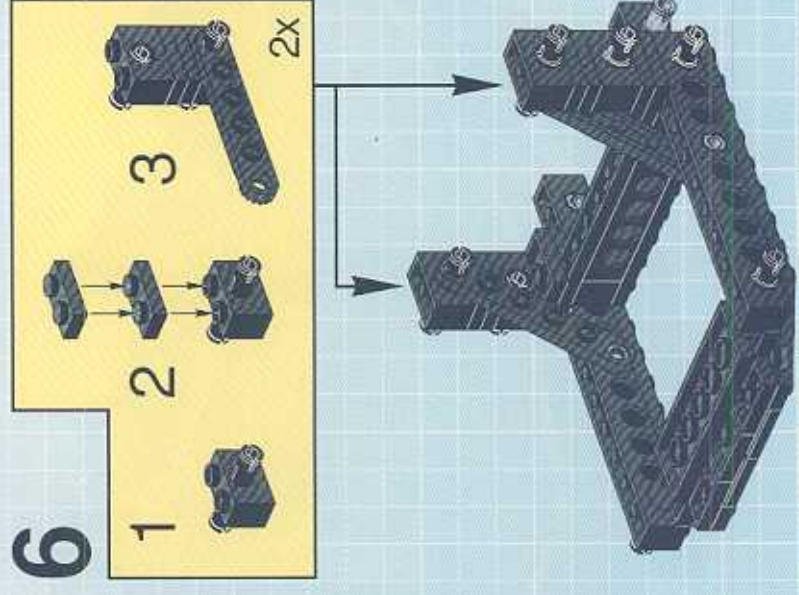
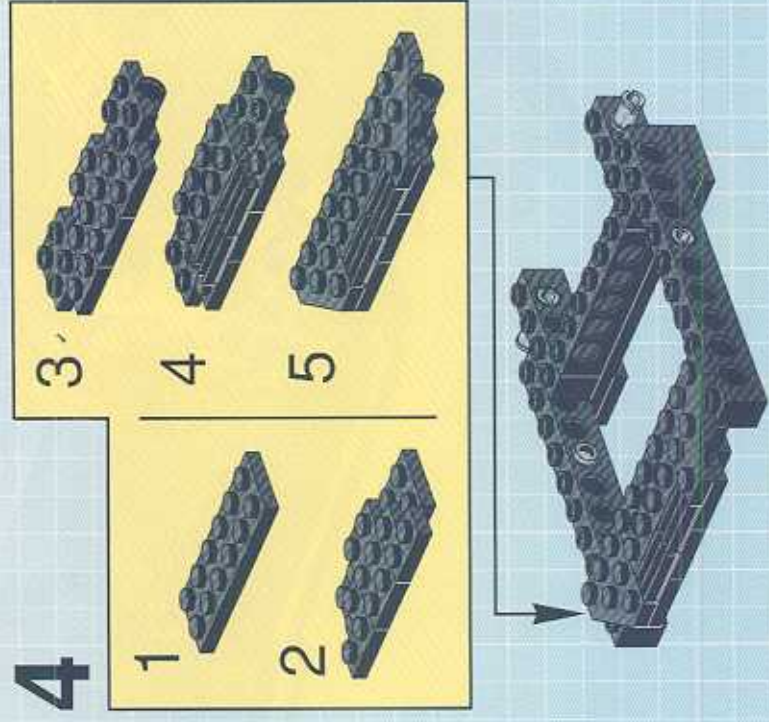
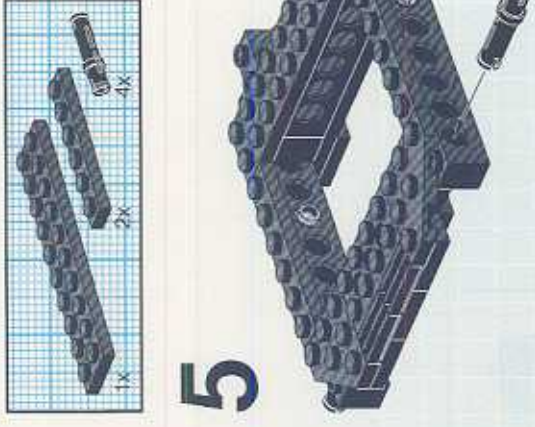
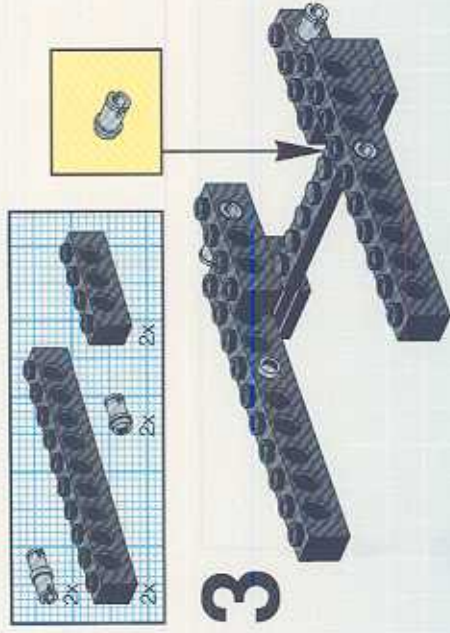
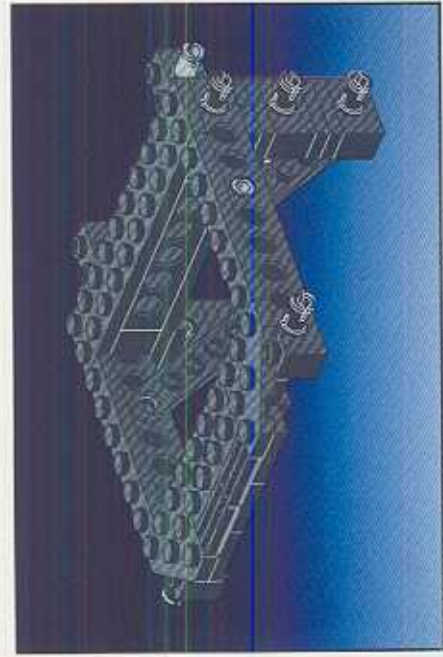

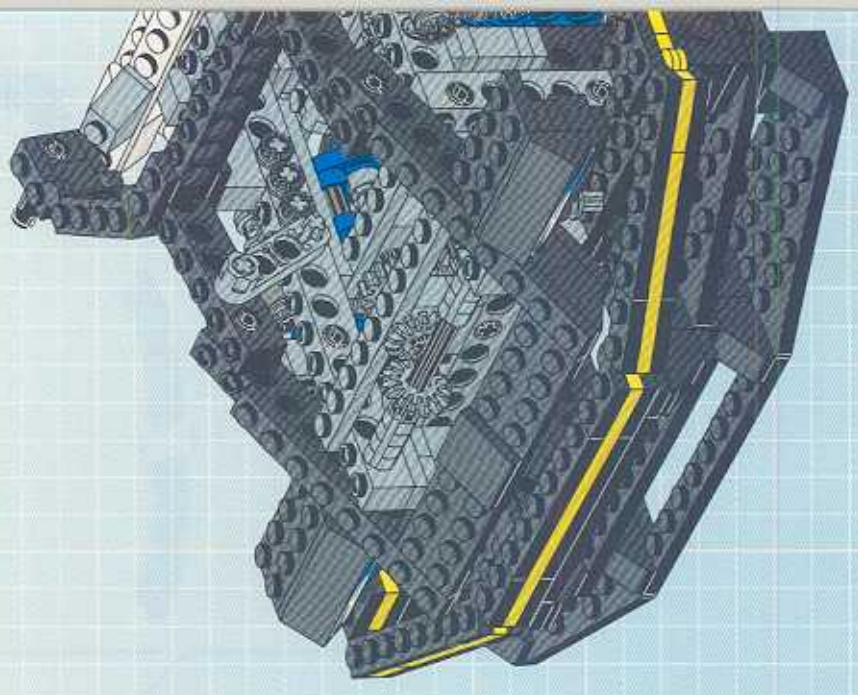

5

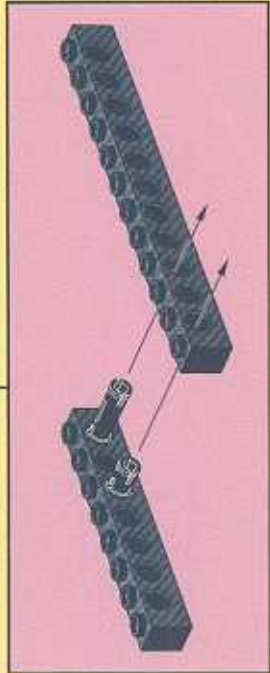

4



3

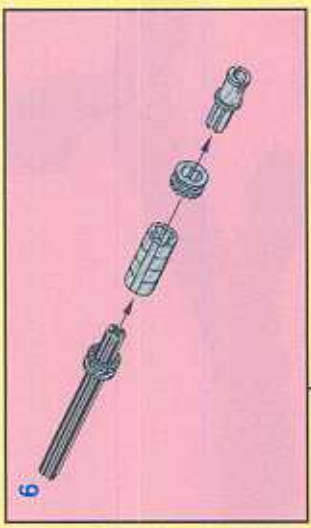

6



1



2

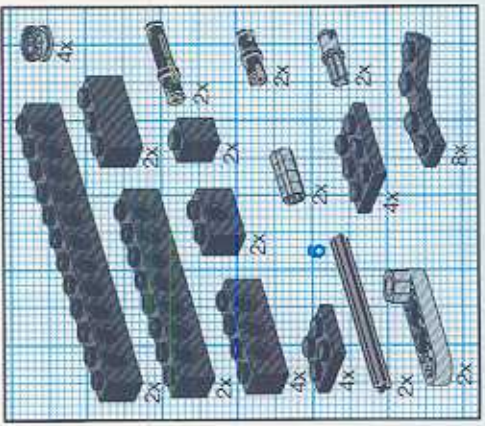

31

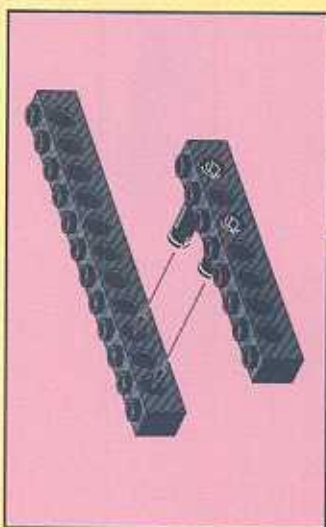
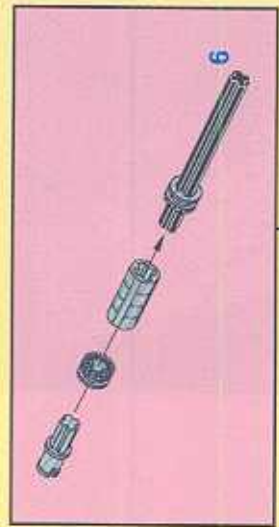
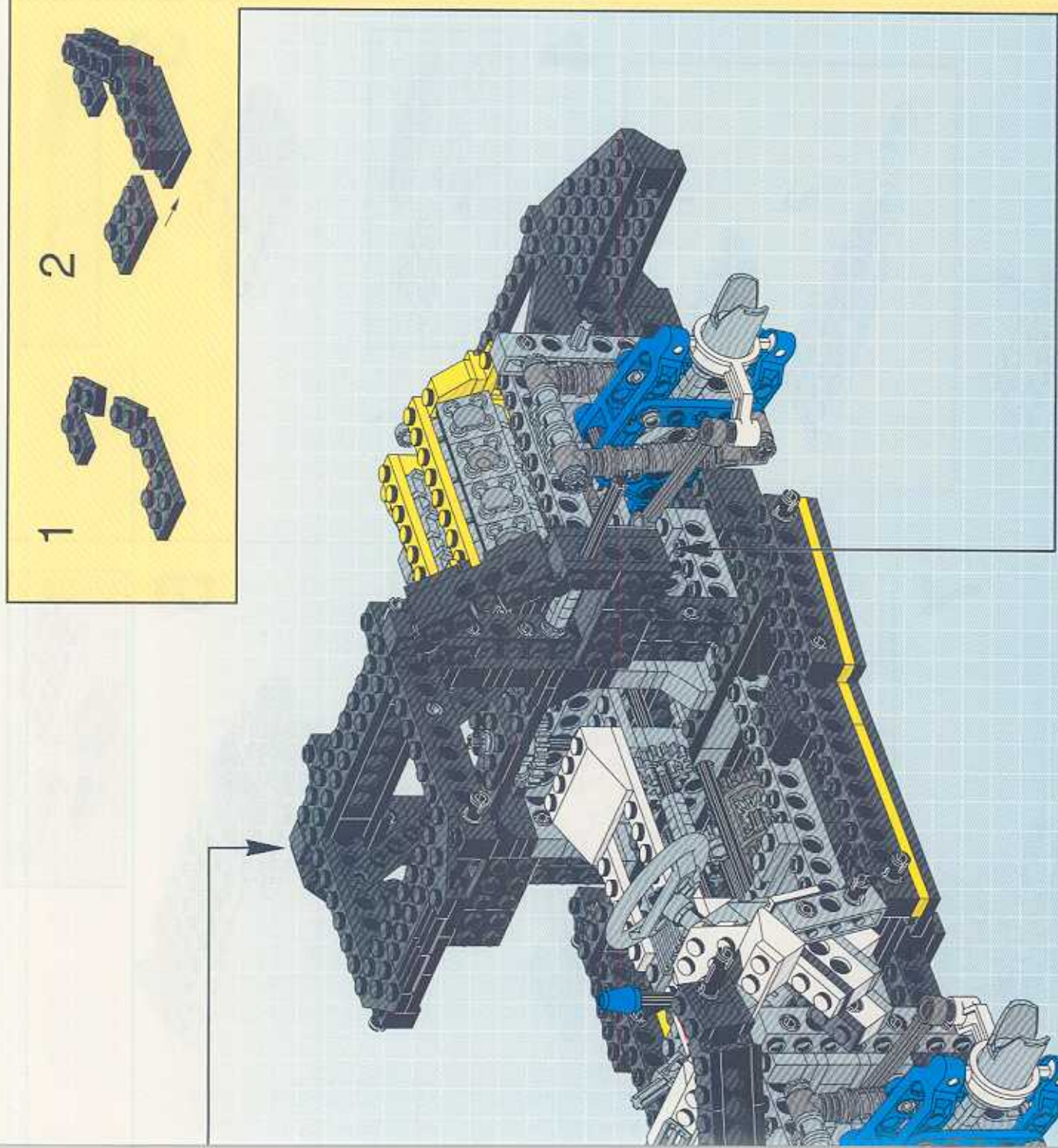

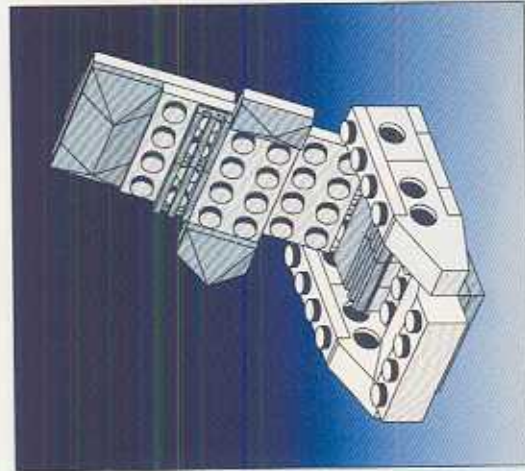

1

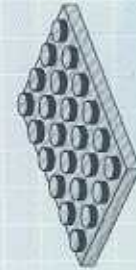

2



3

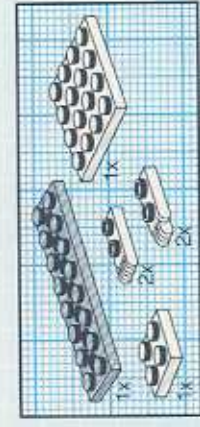
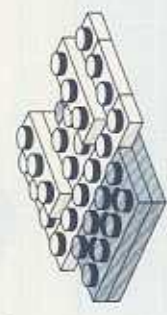

4

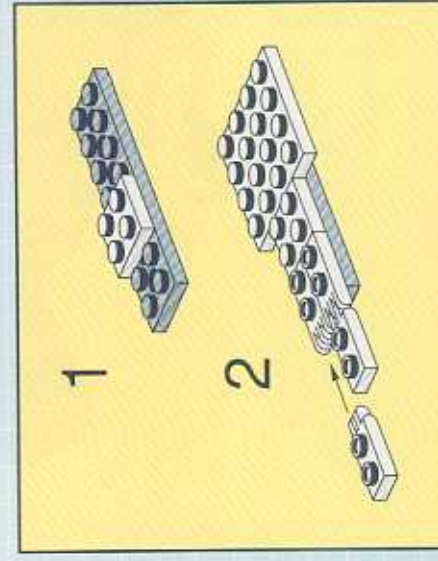

5

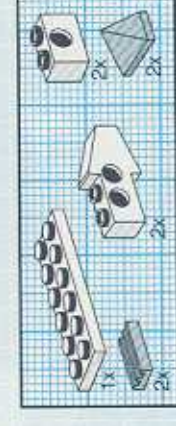
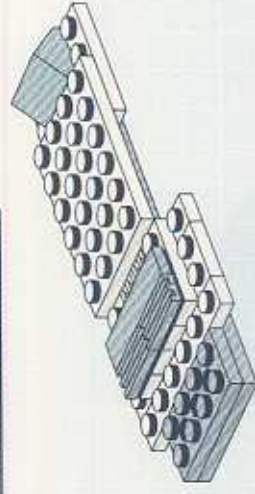

6

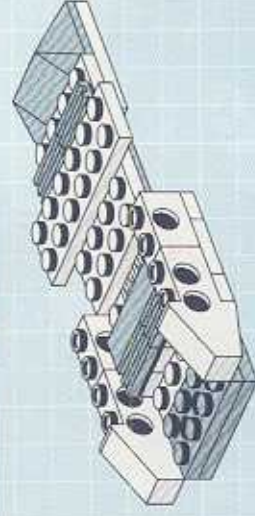

7

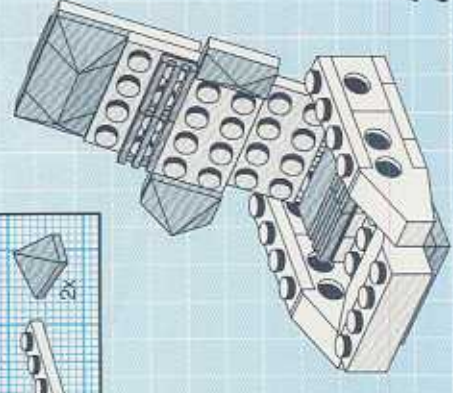

2x

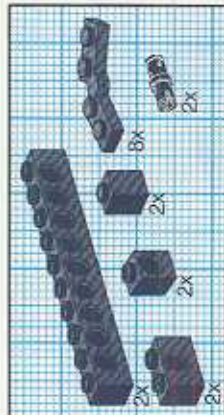
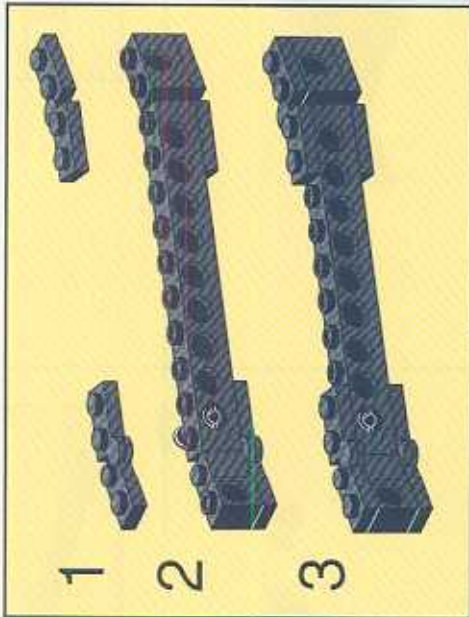
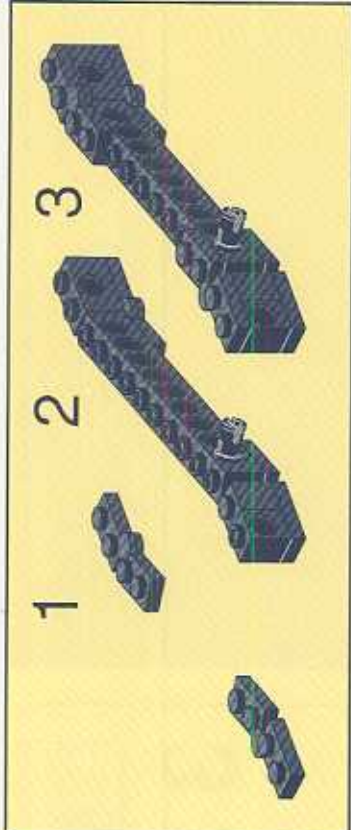
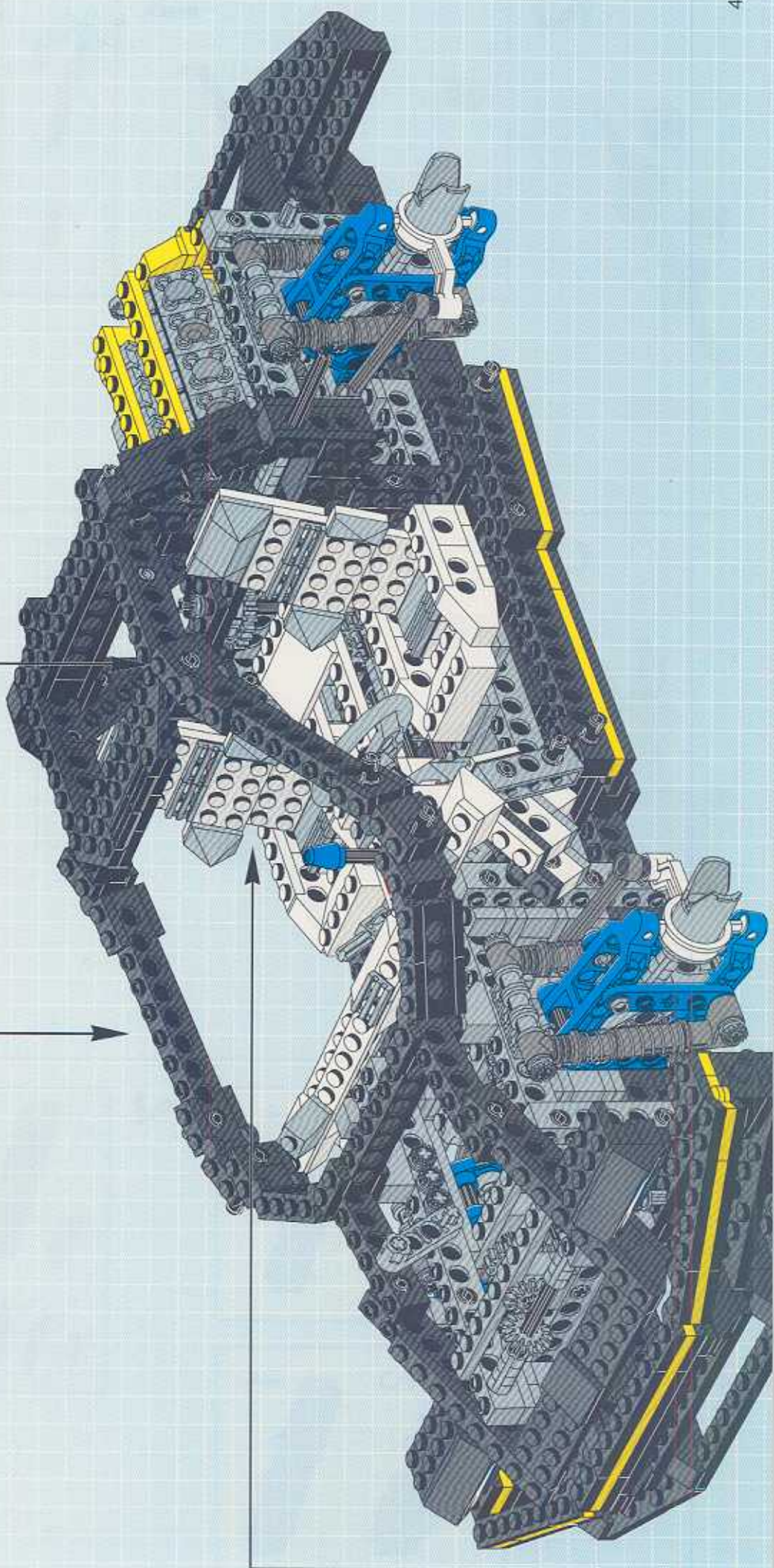

32

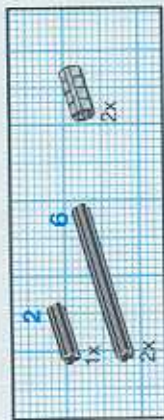
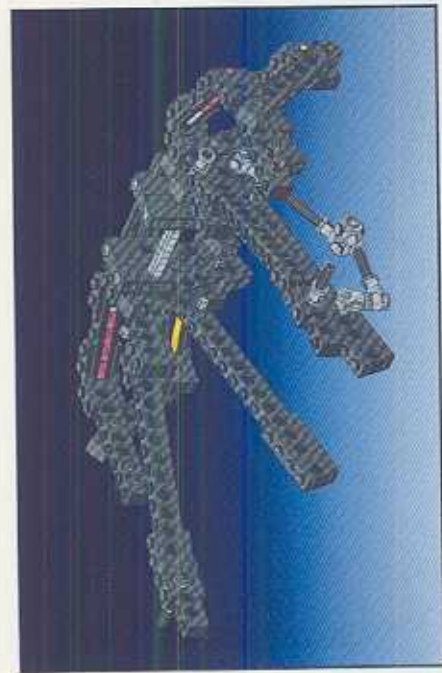

1

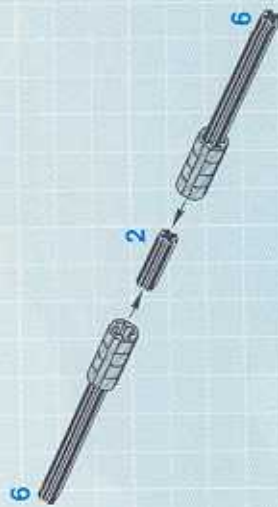

2



3



4



5



6



7

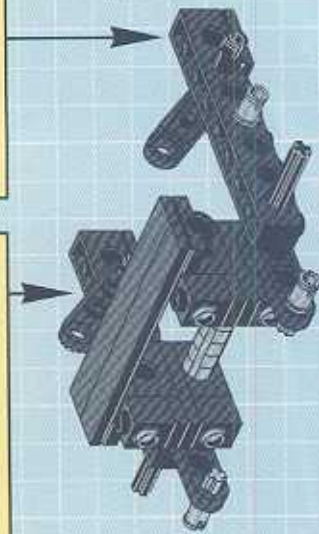
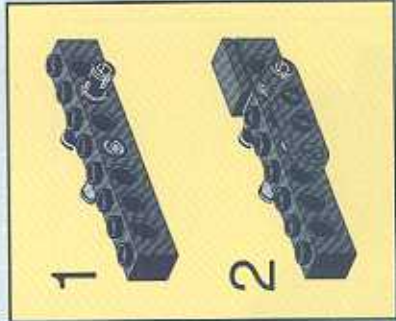
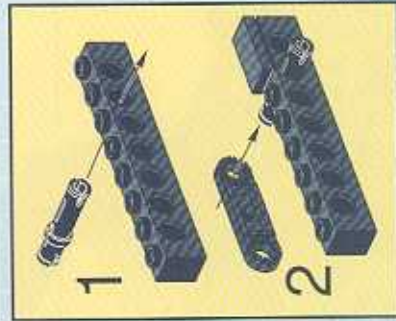

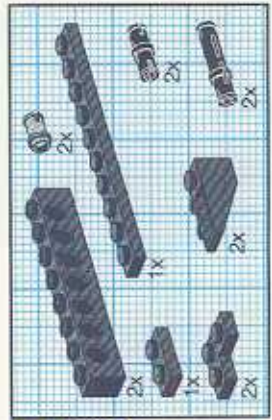

8

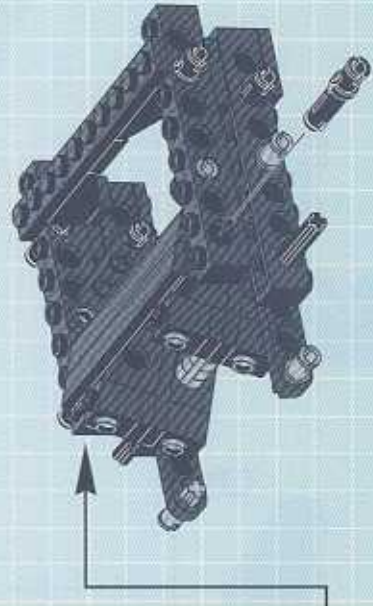
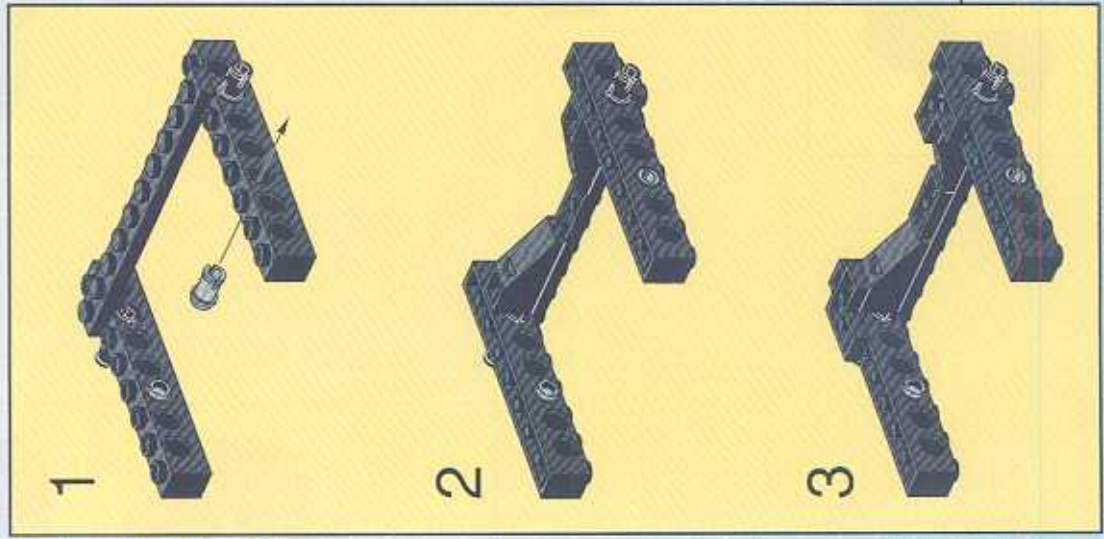

9

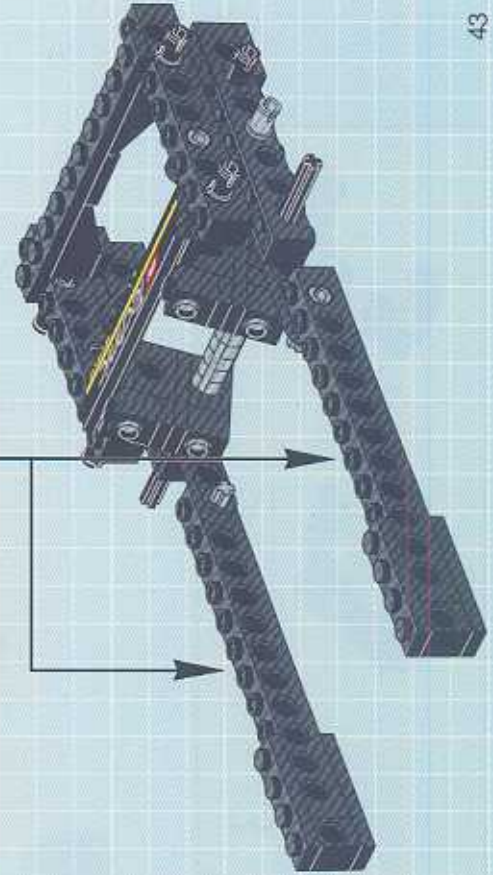
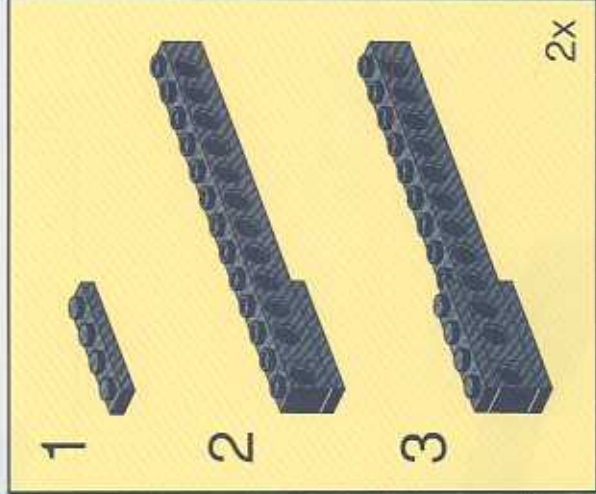

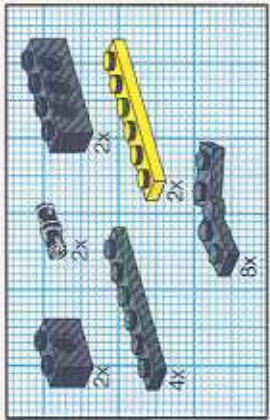

10

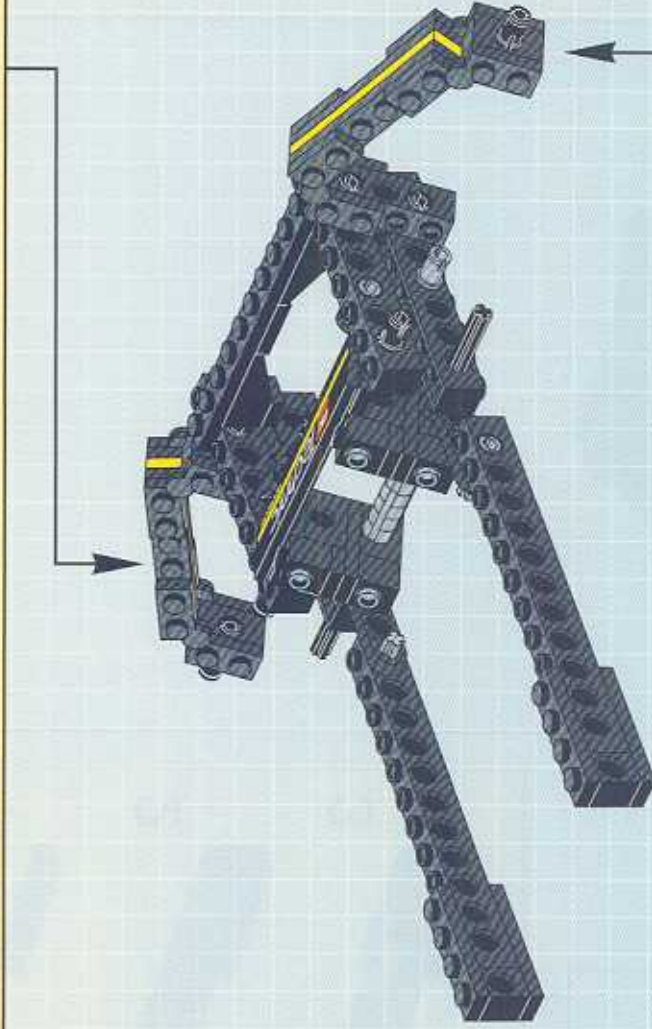
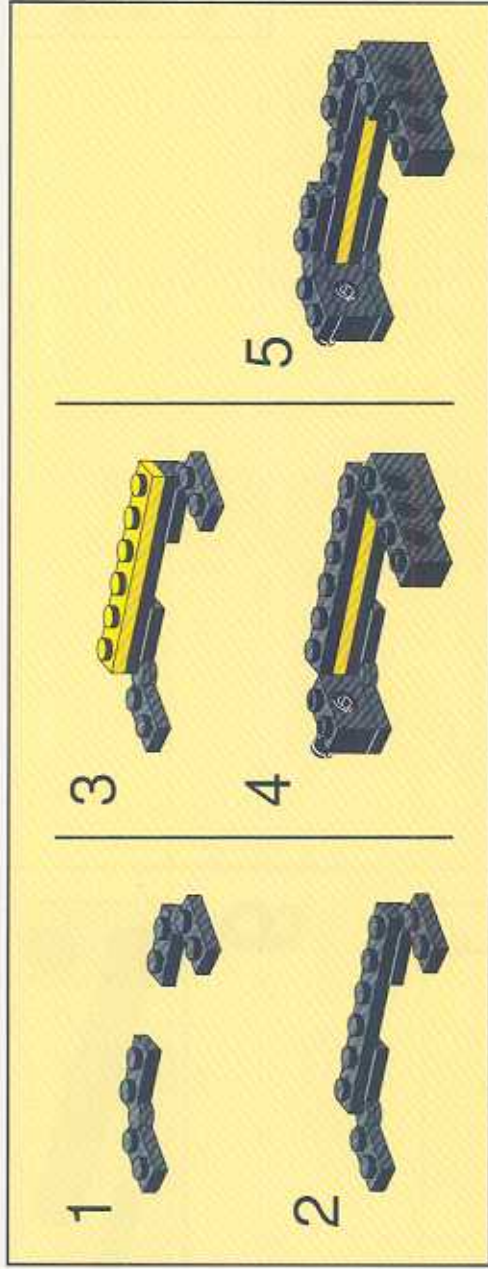

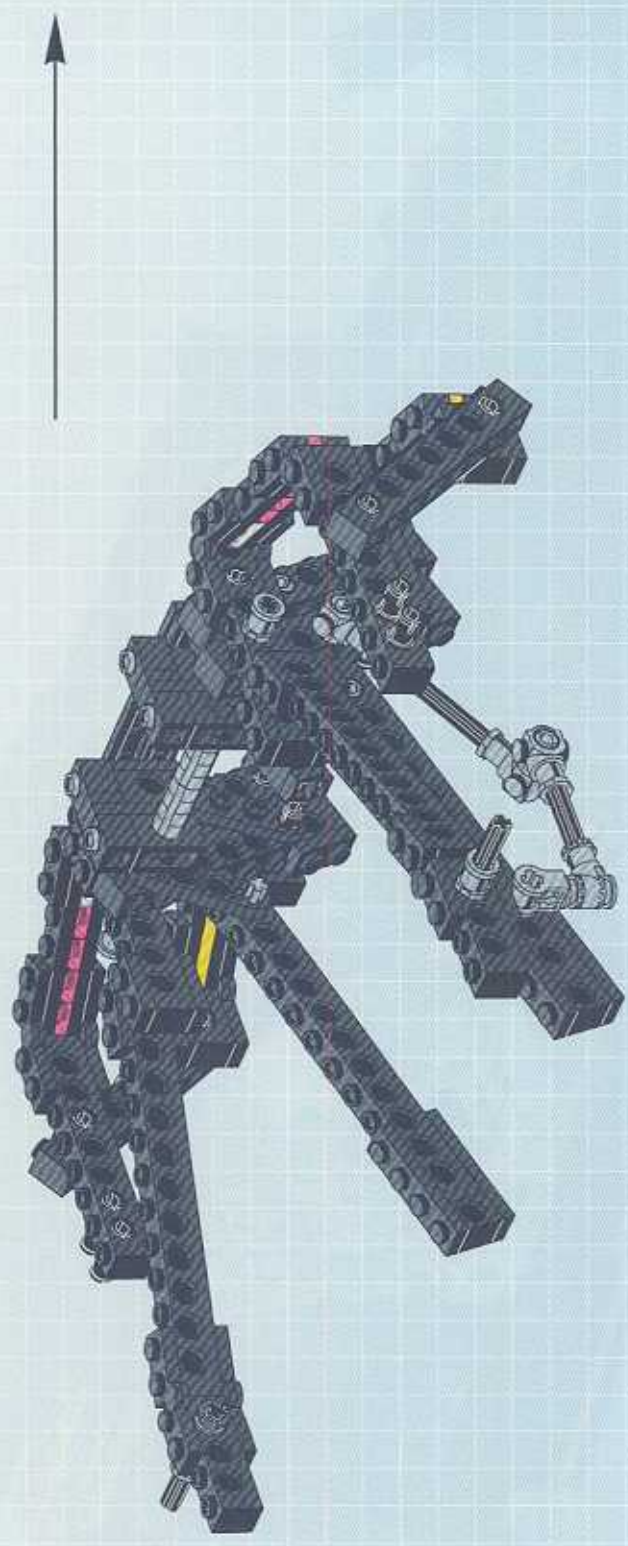

14

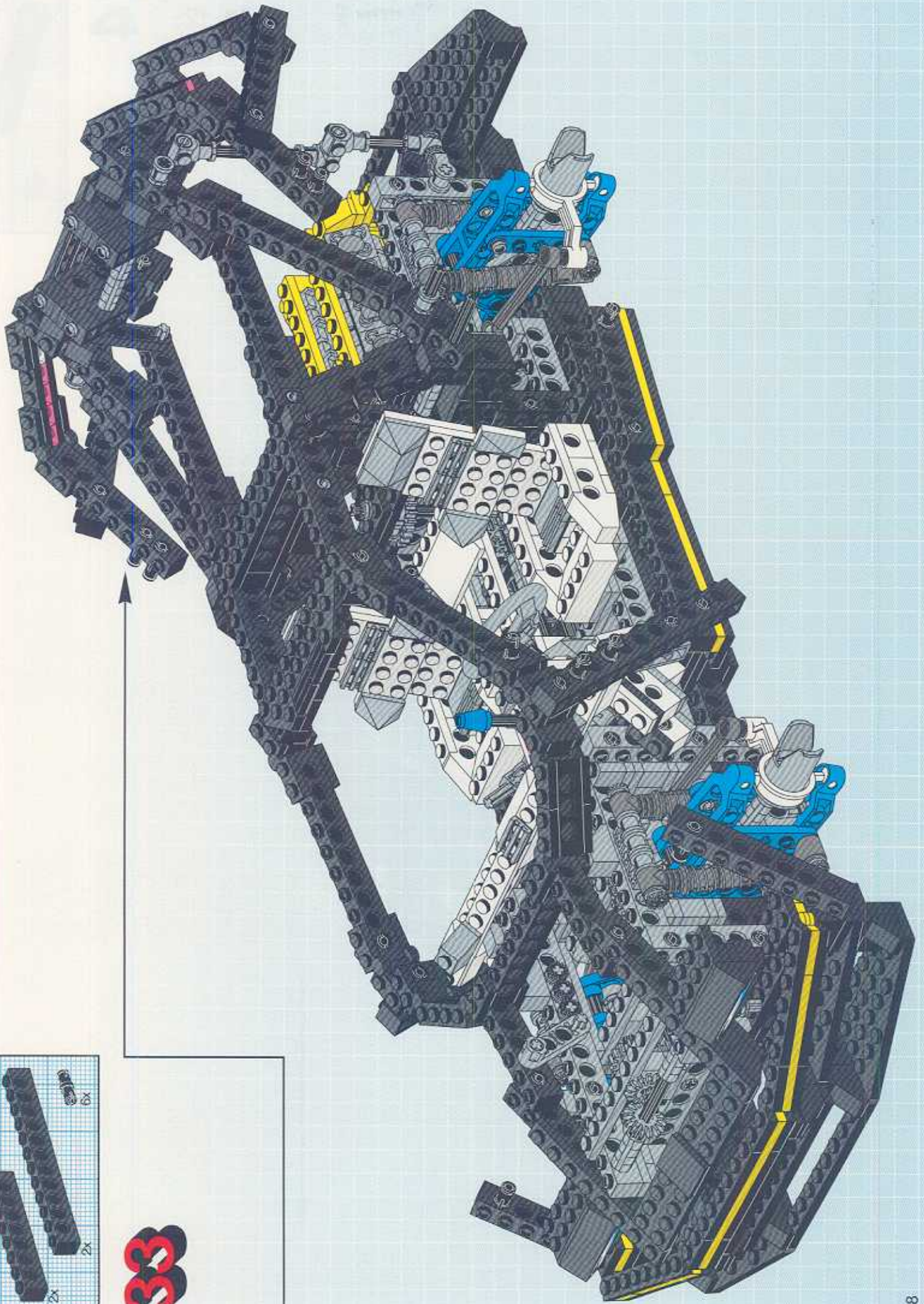

33



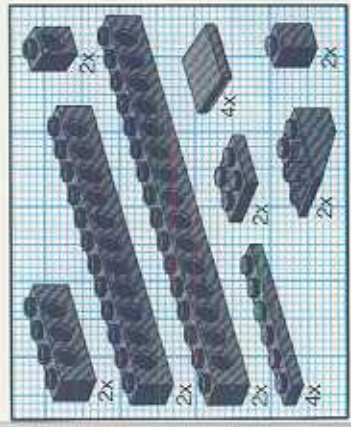
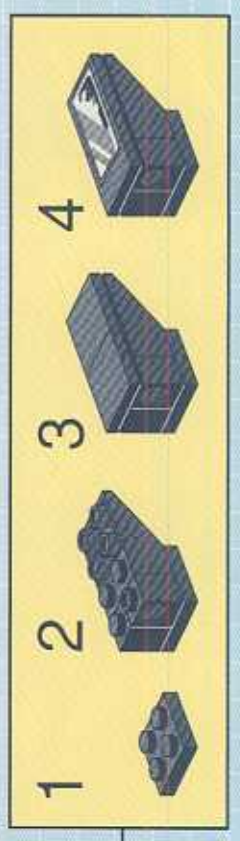
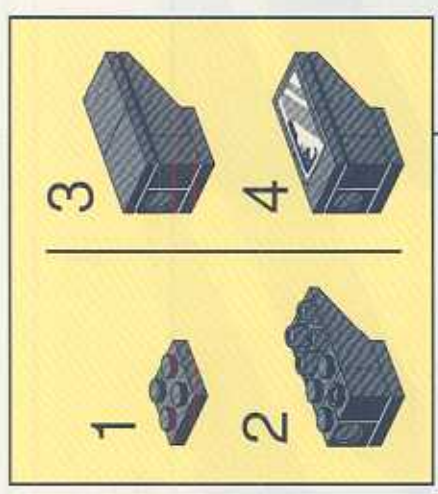
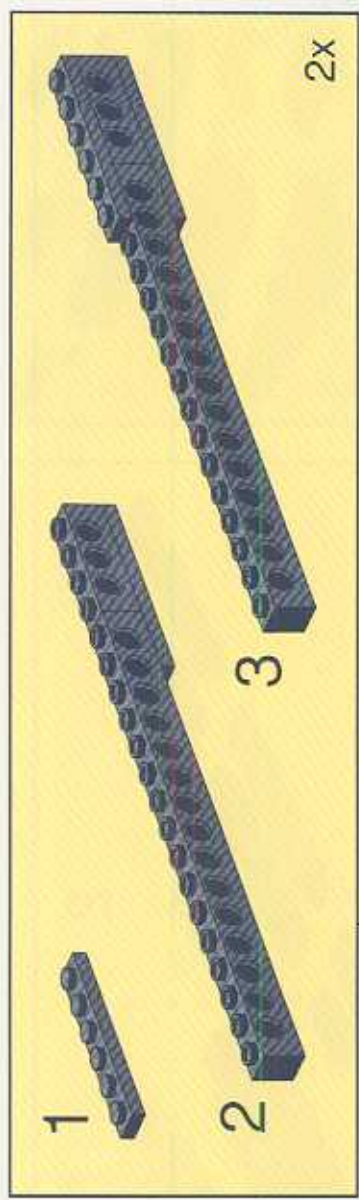
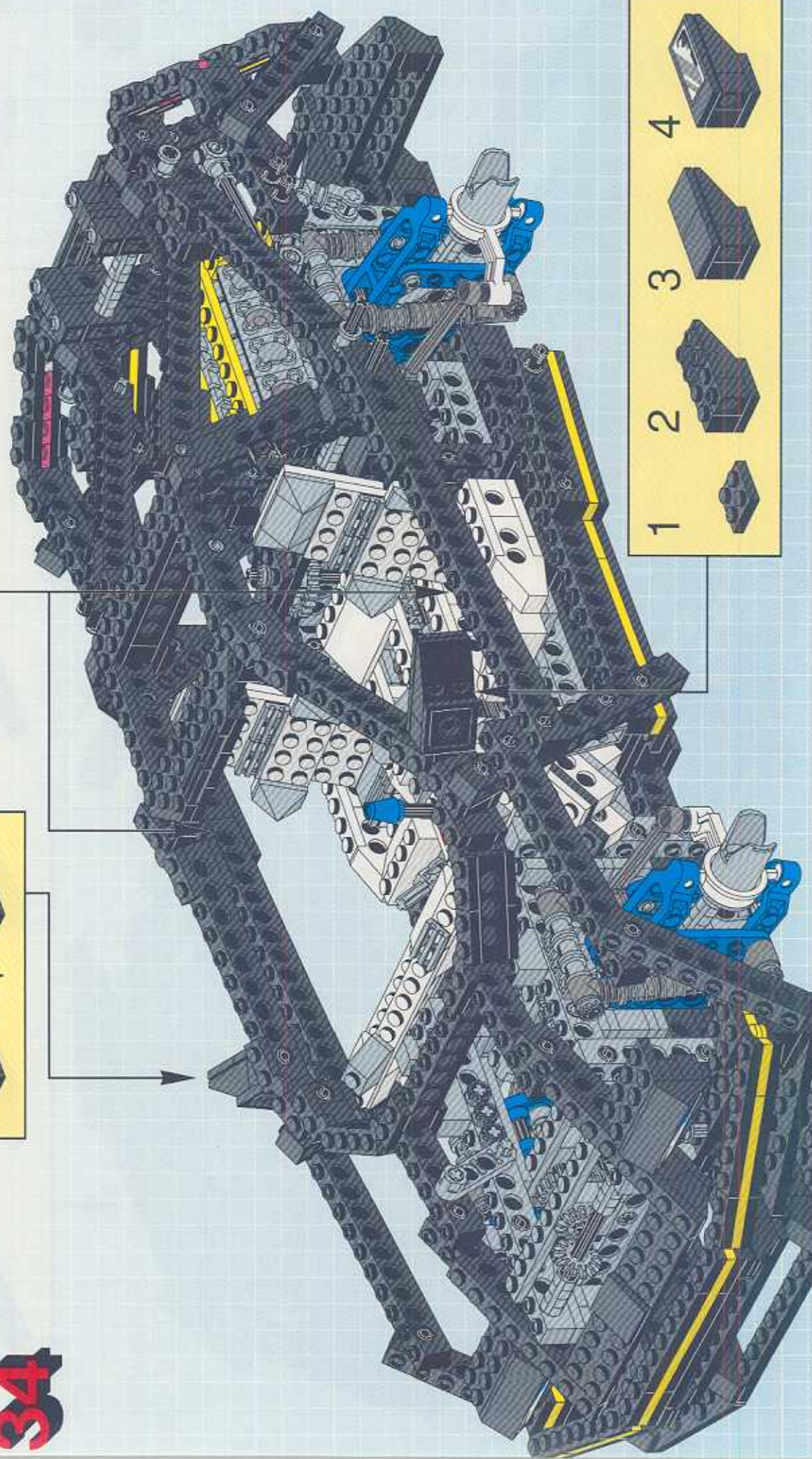

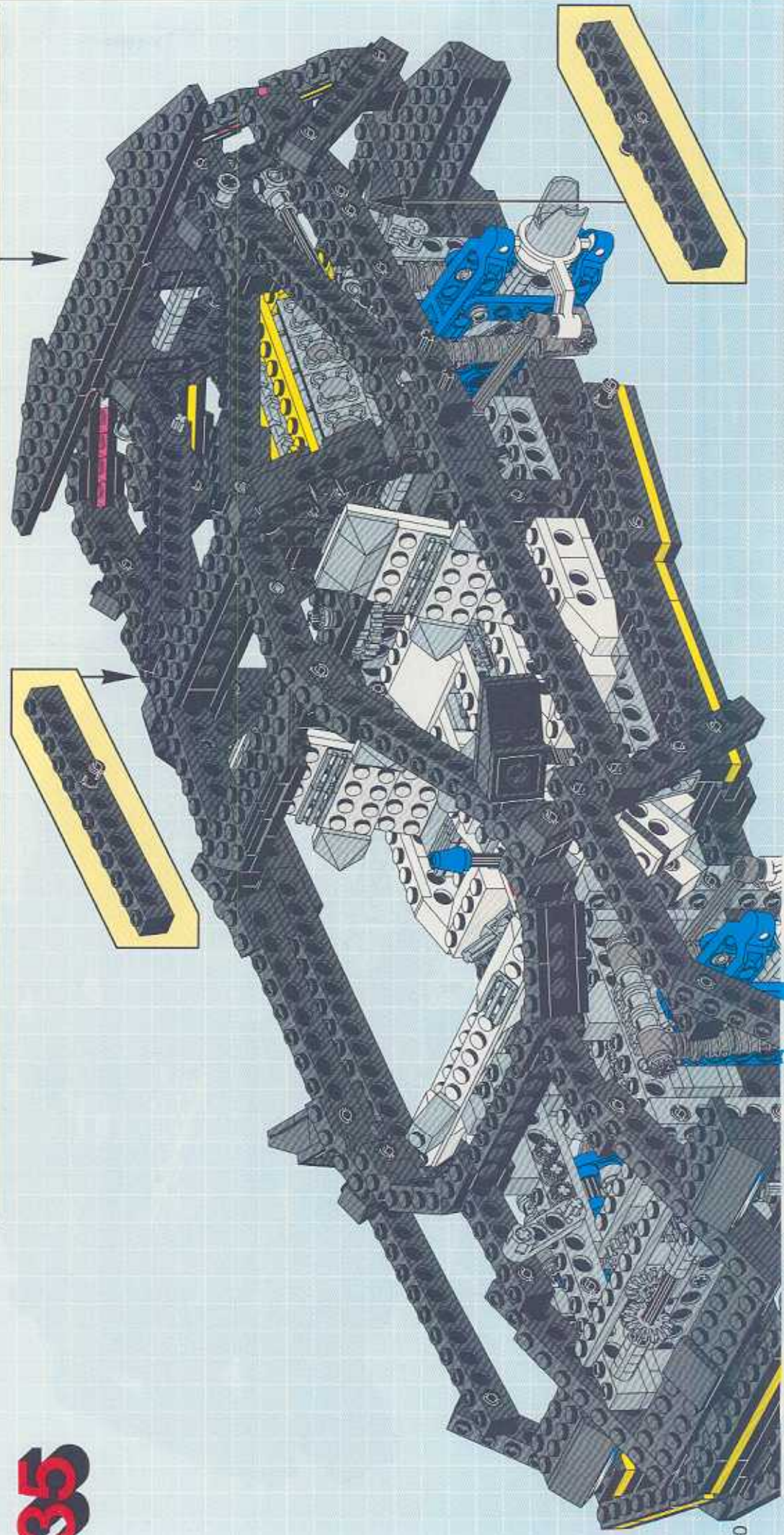
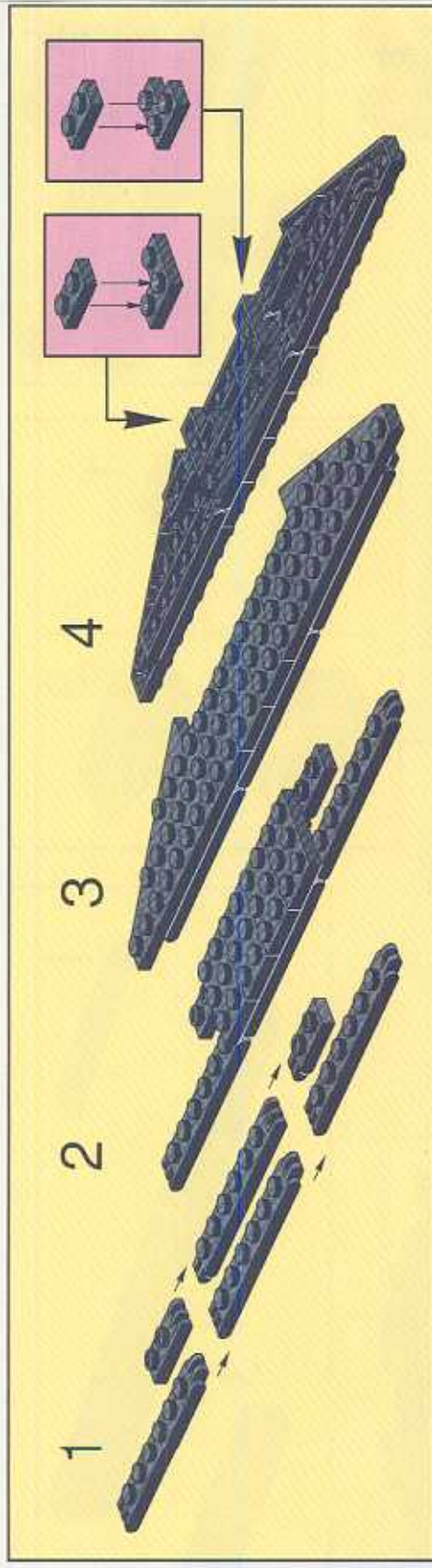
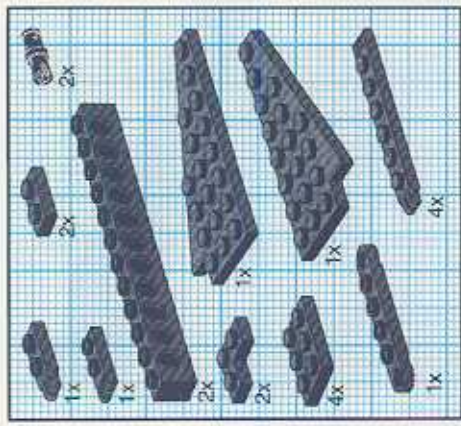

35

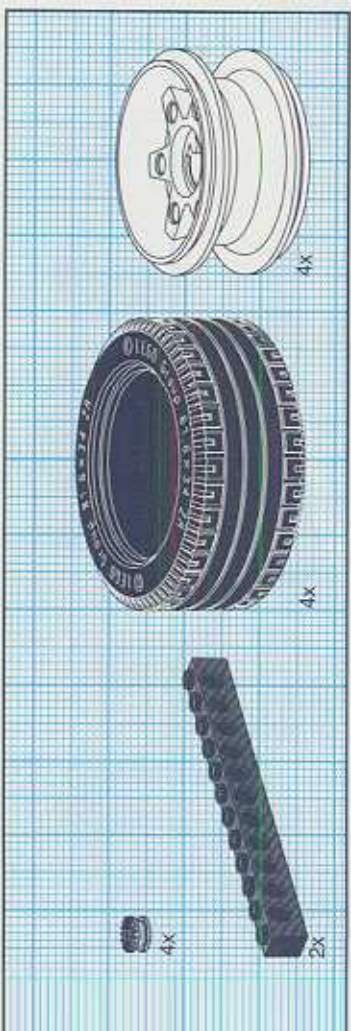
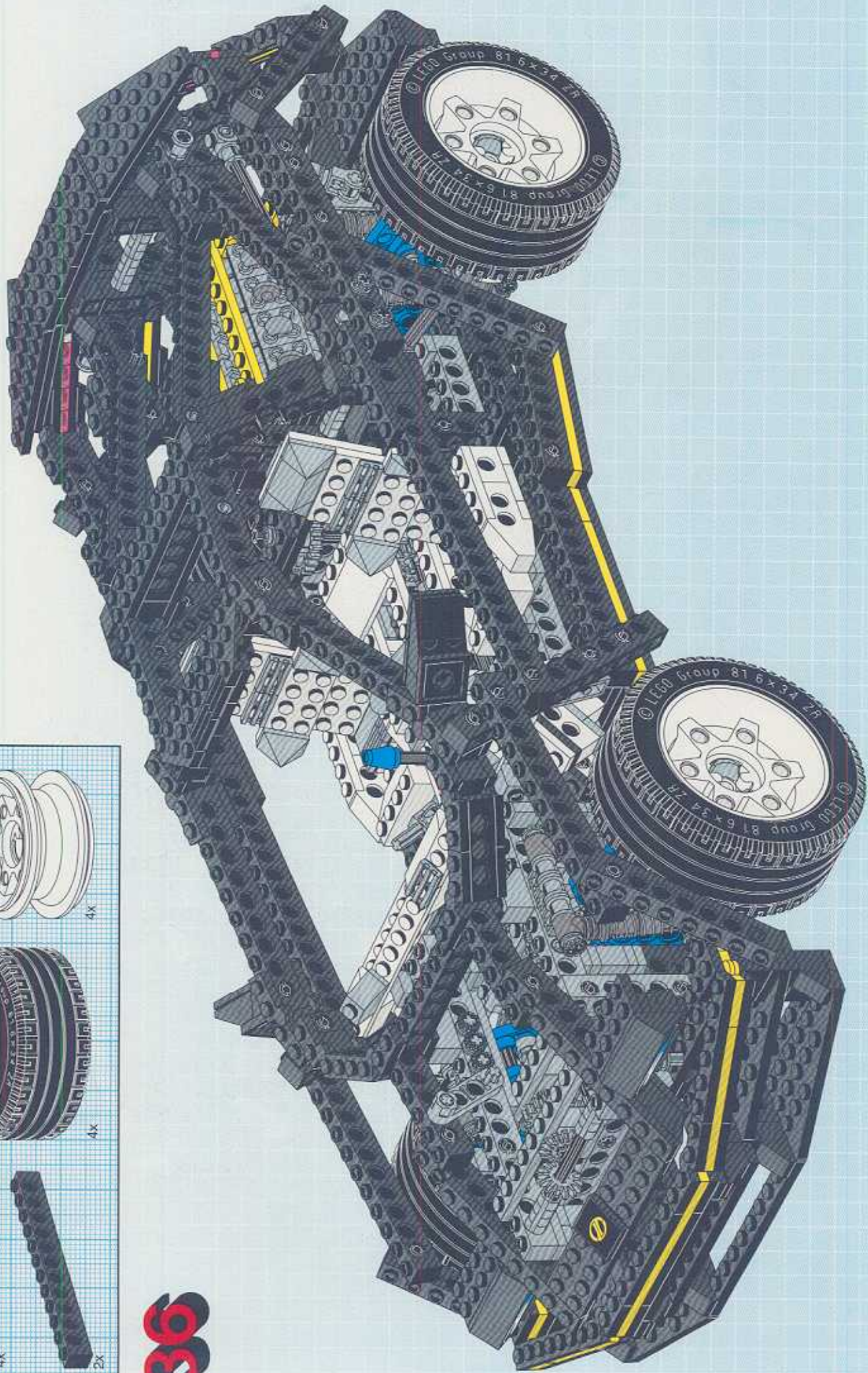

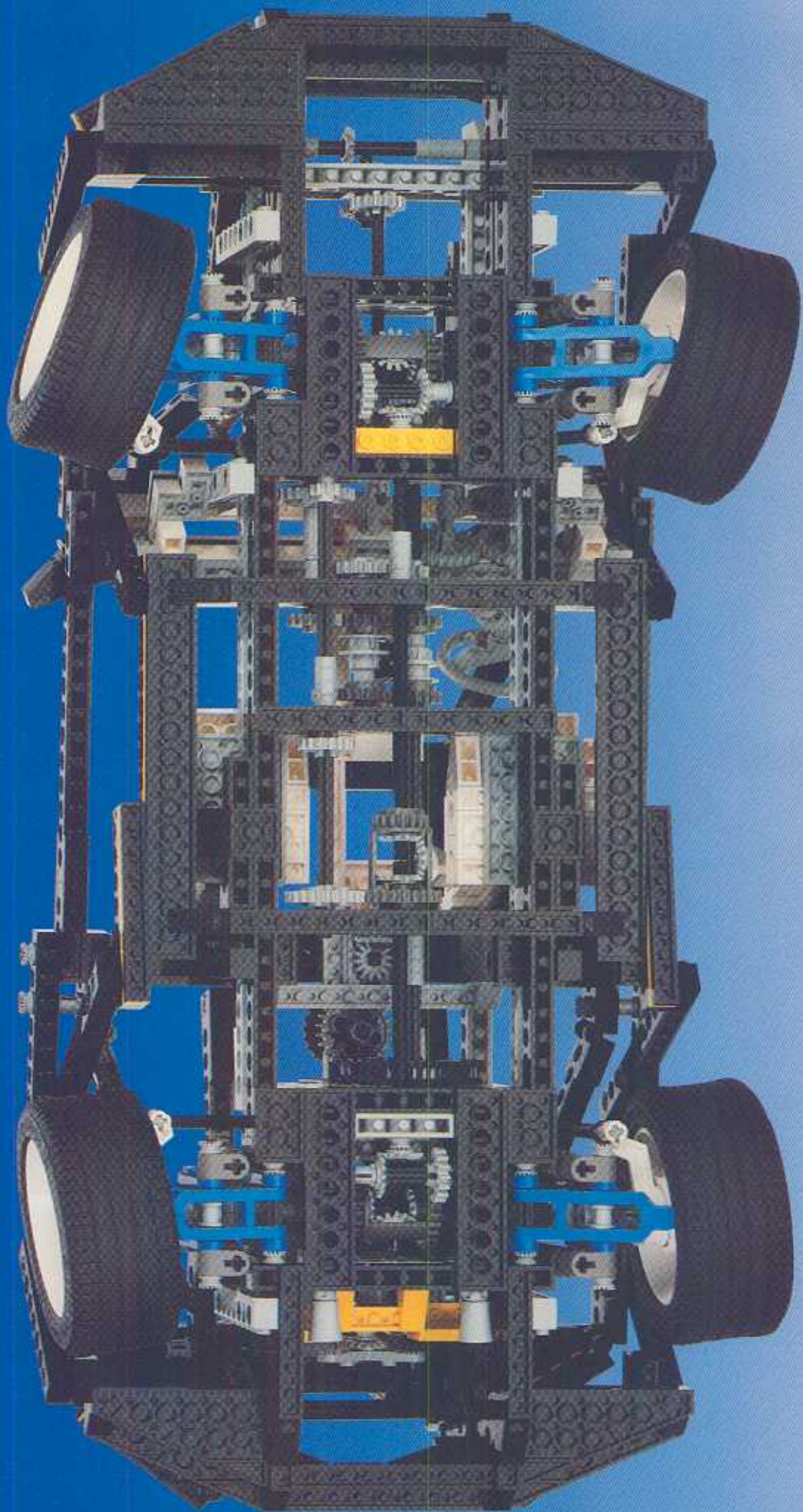

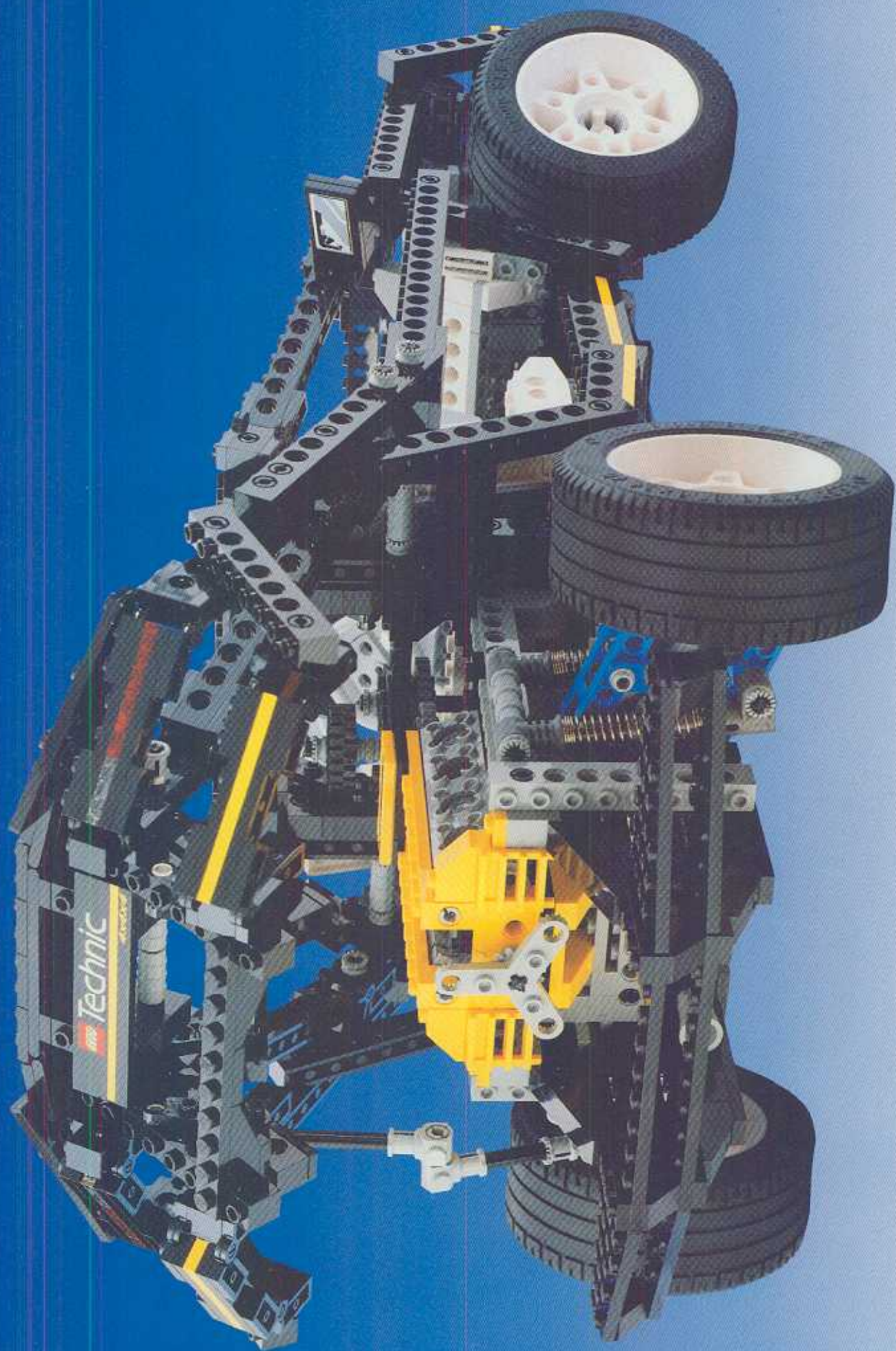

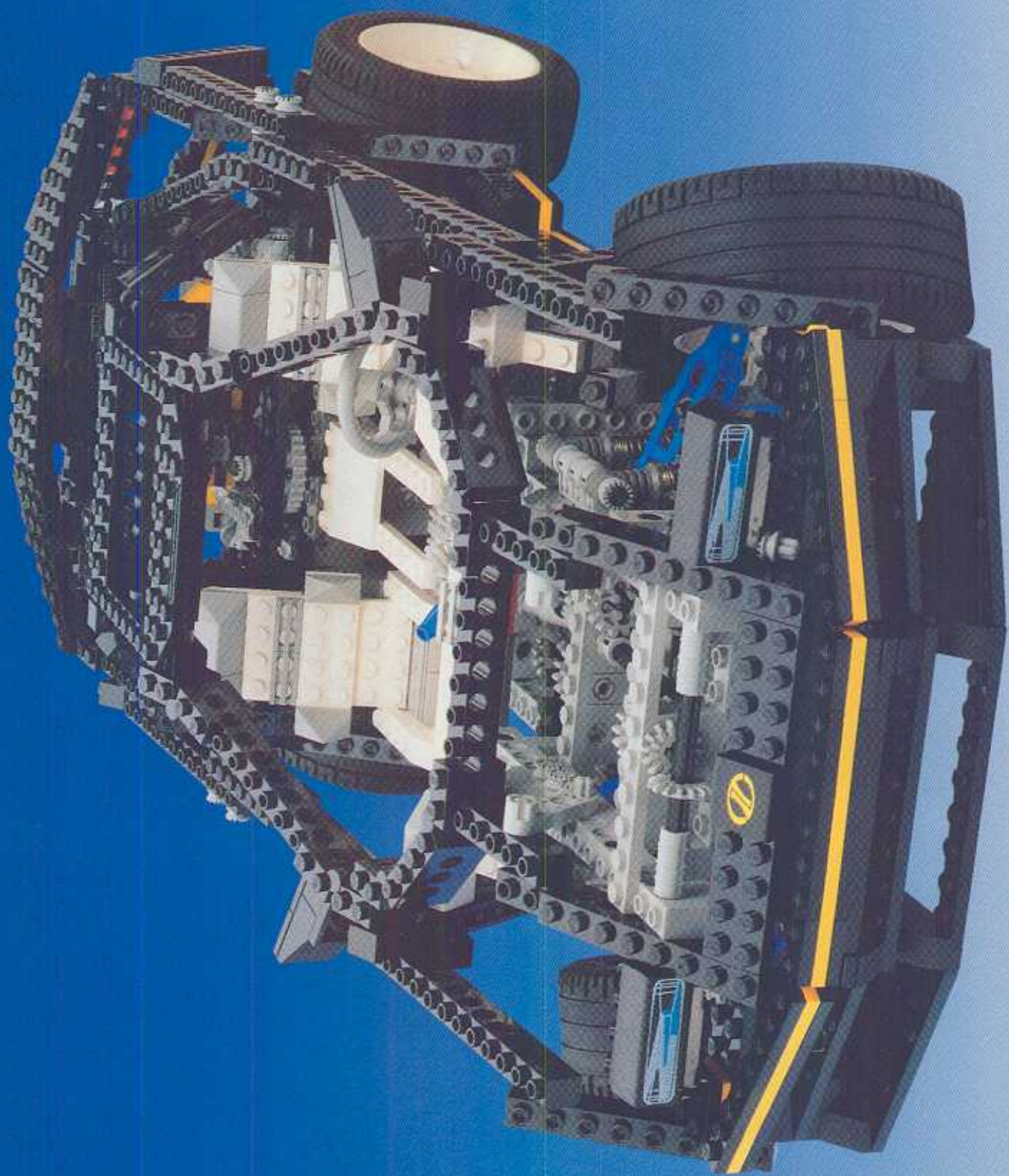

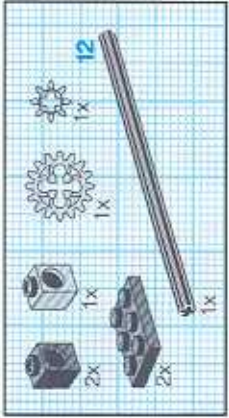

3

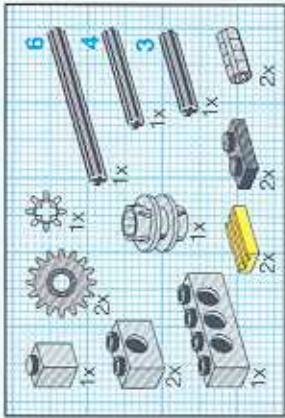
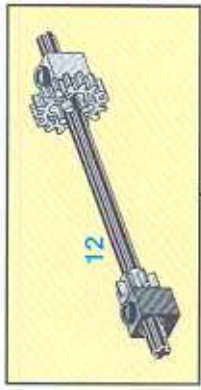

4

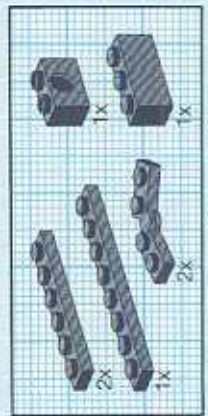
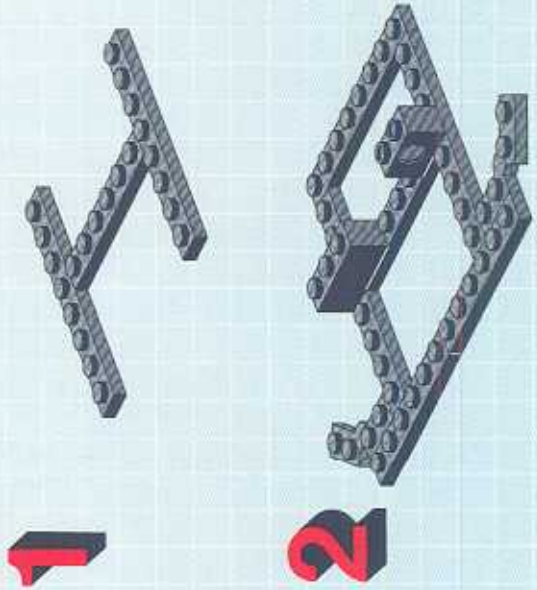
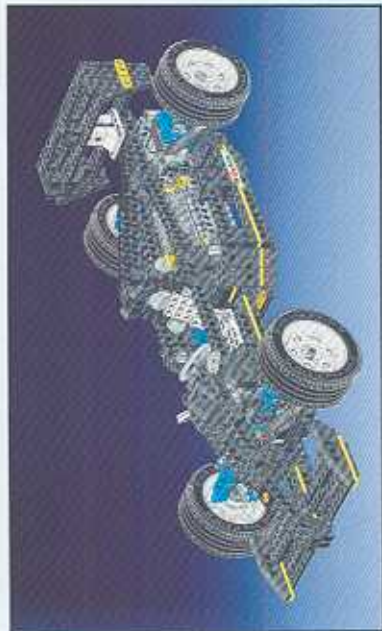
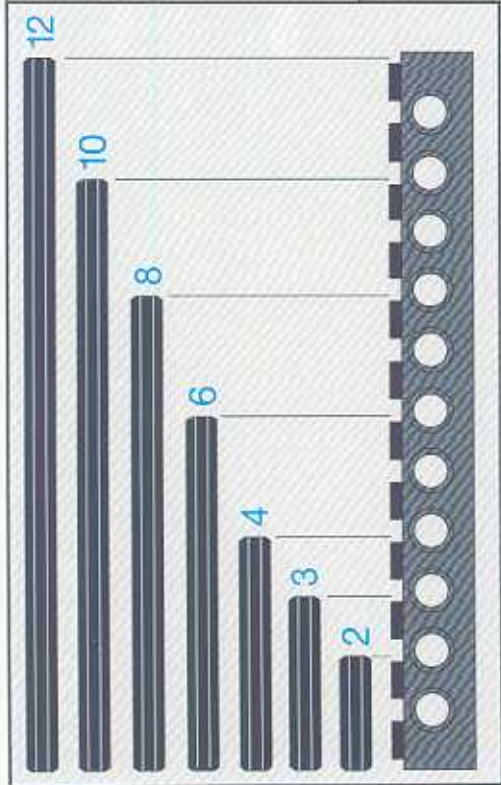
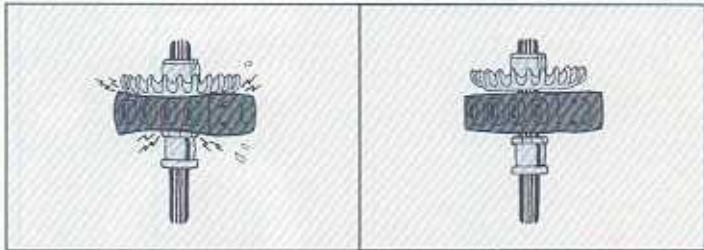
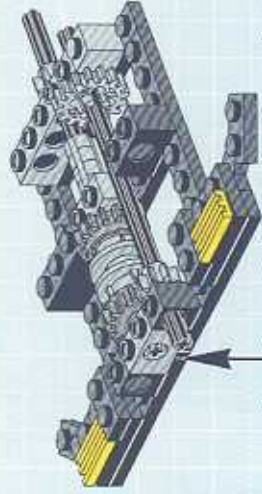
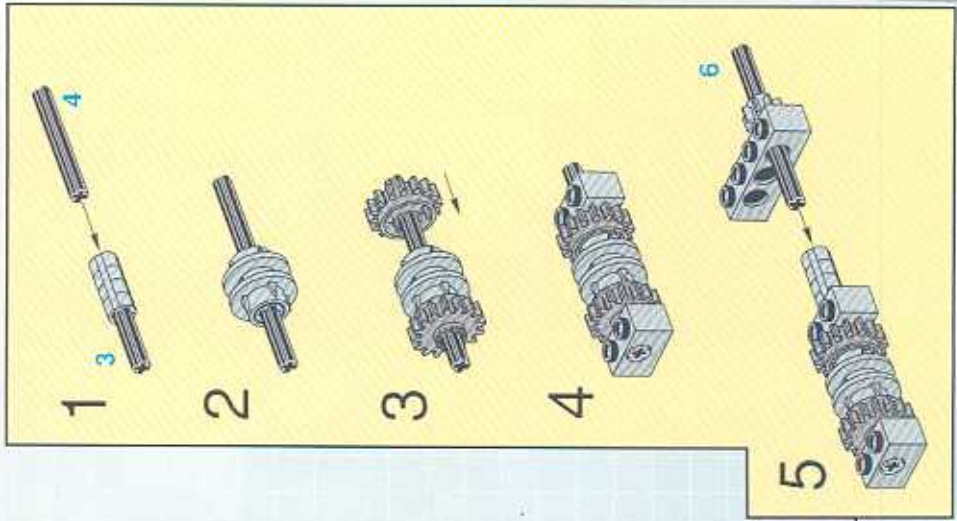

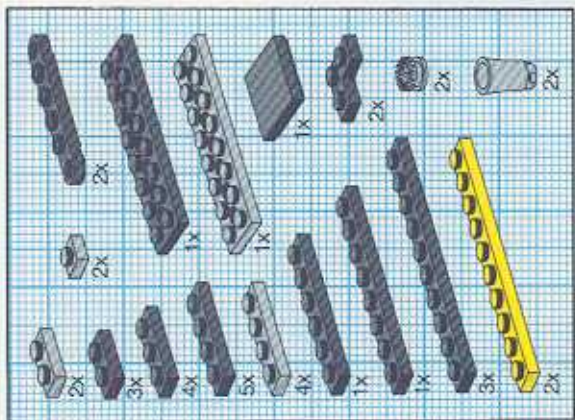
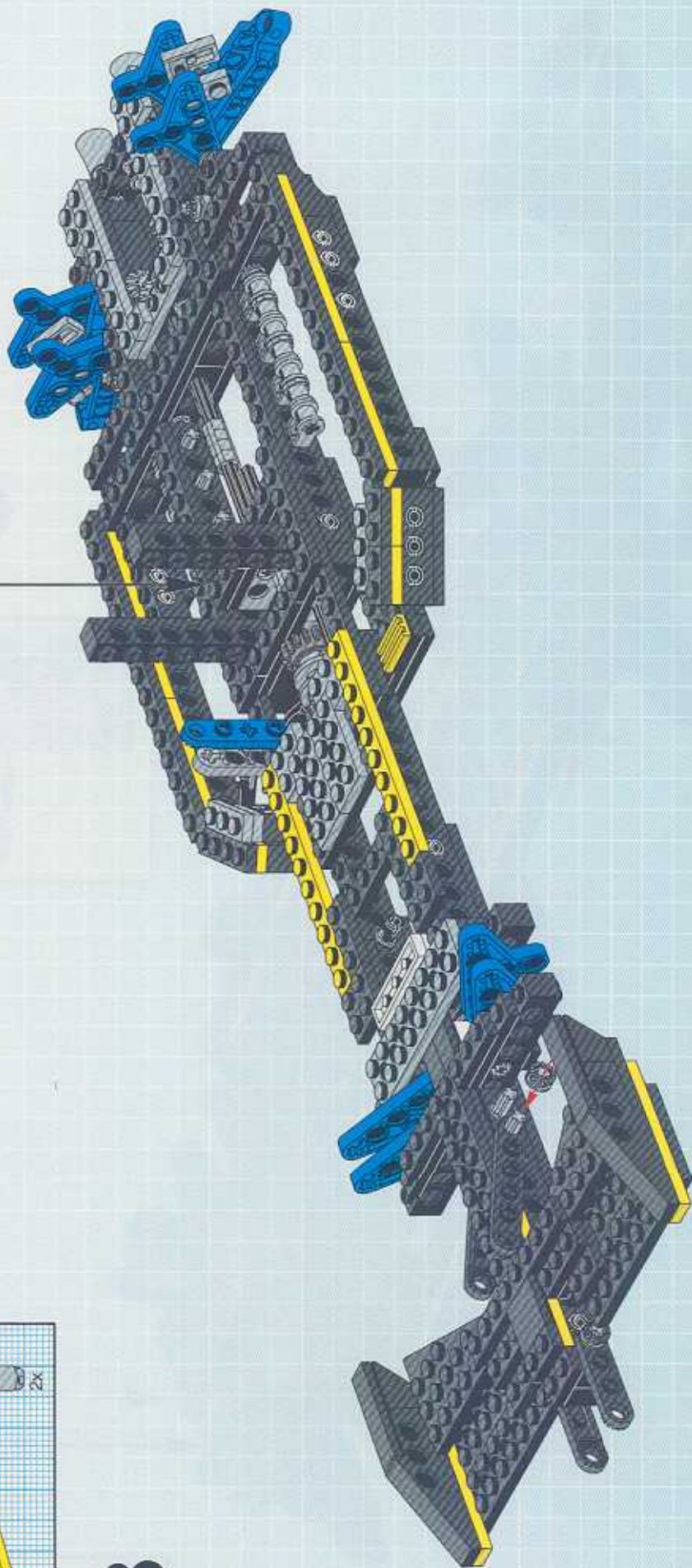

13

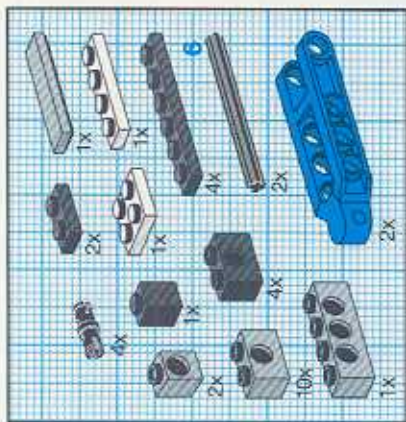

14

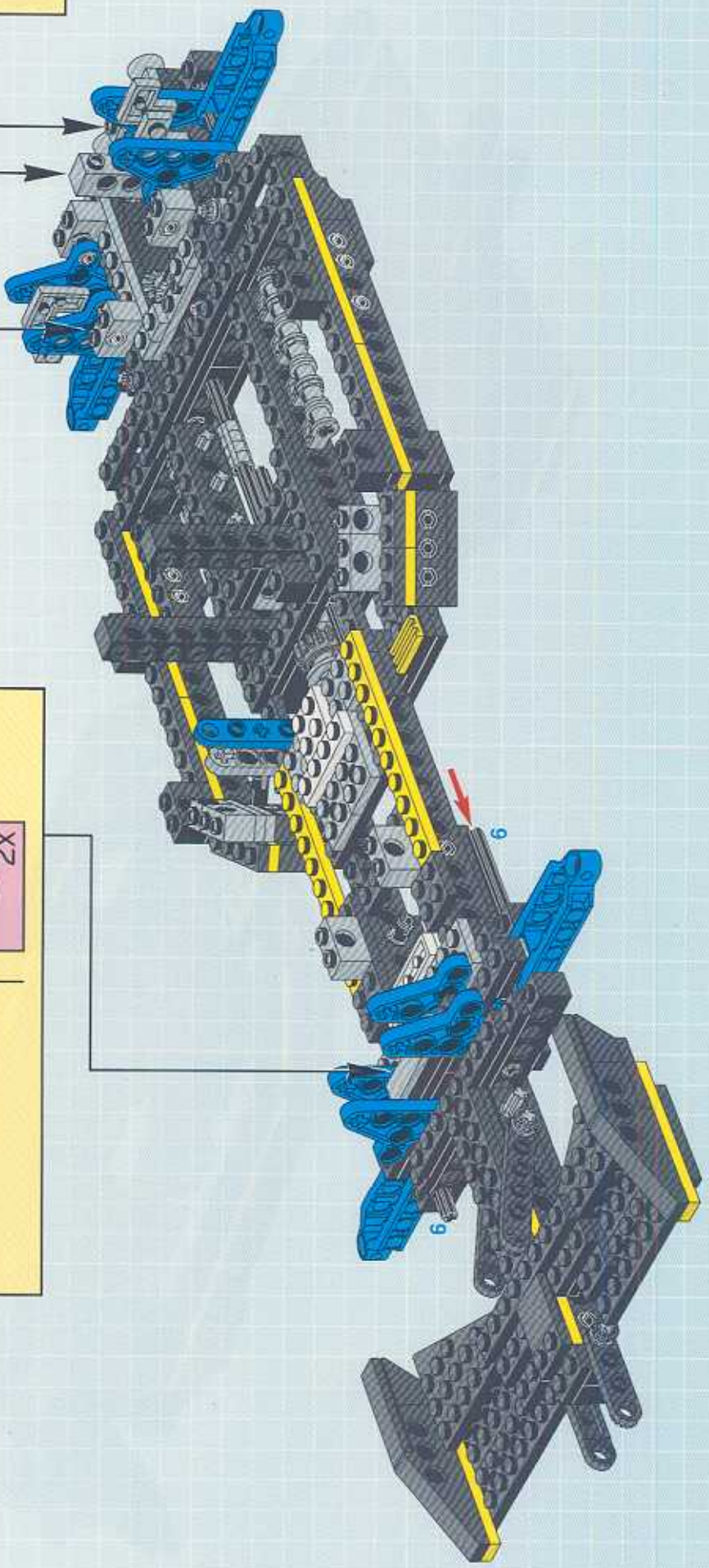
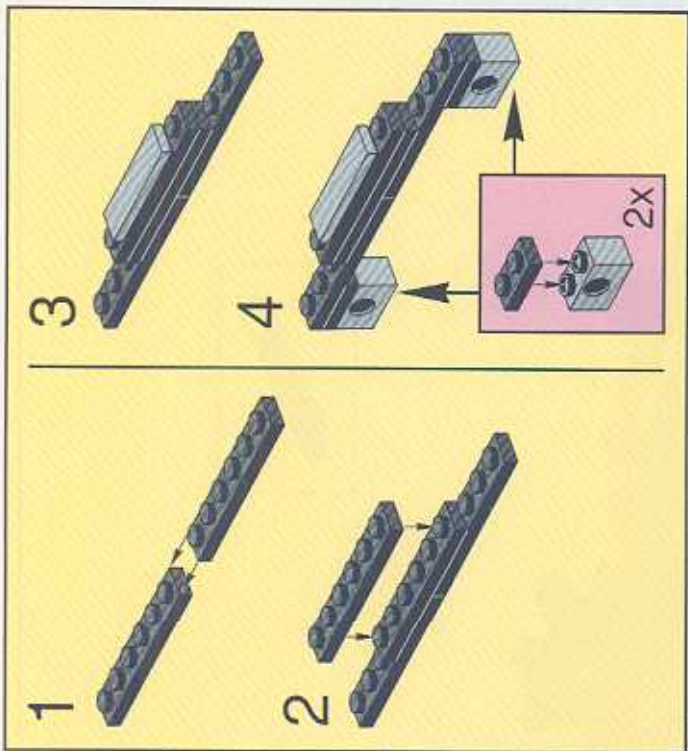

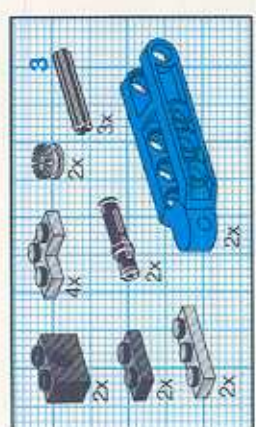
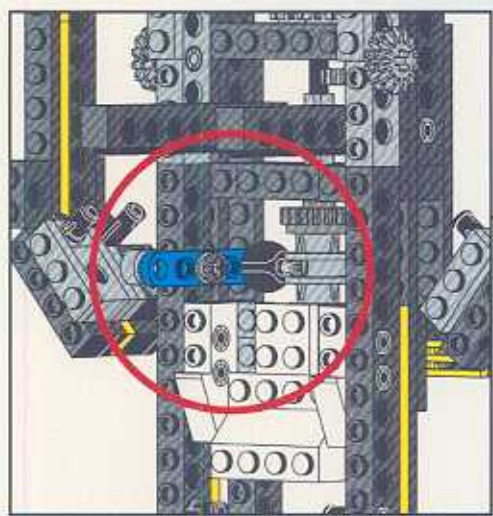
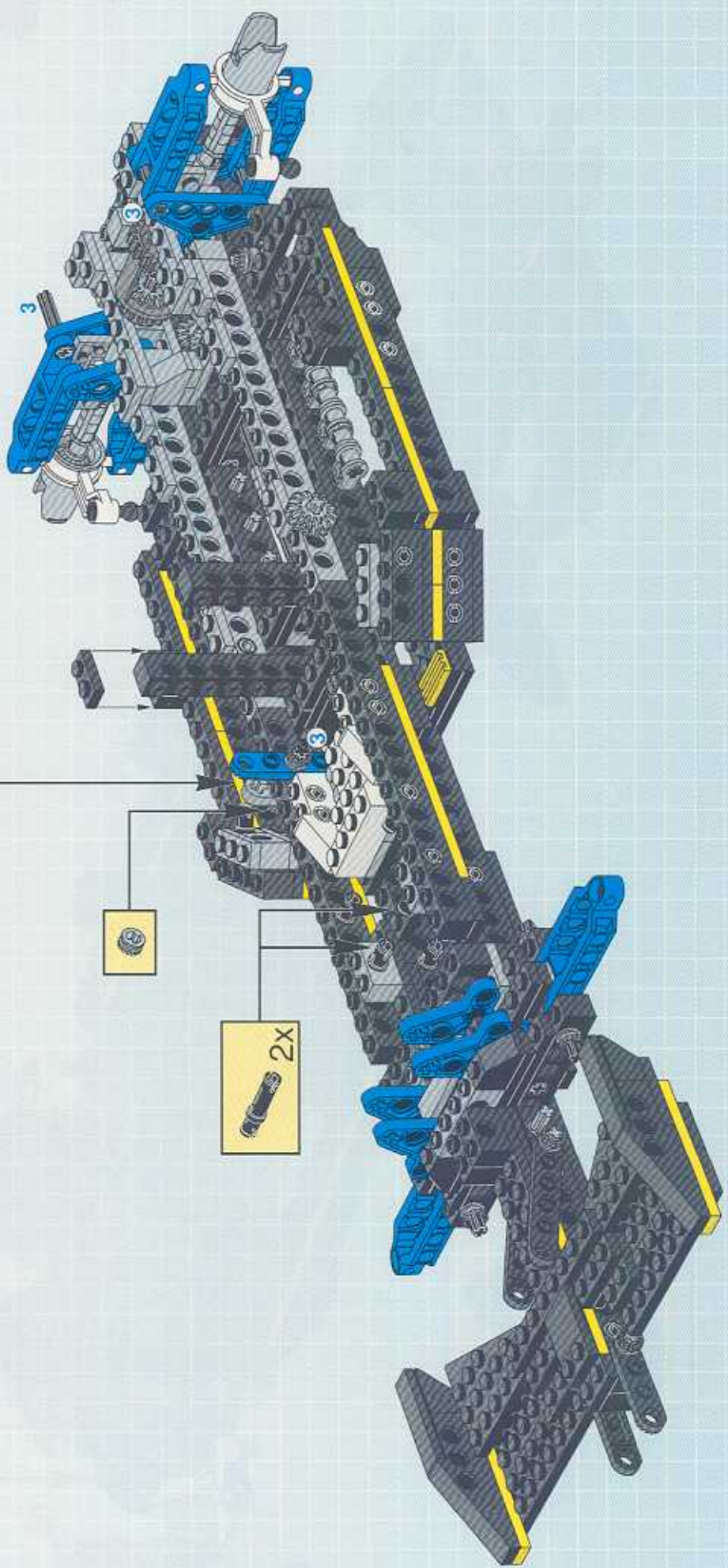

17



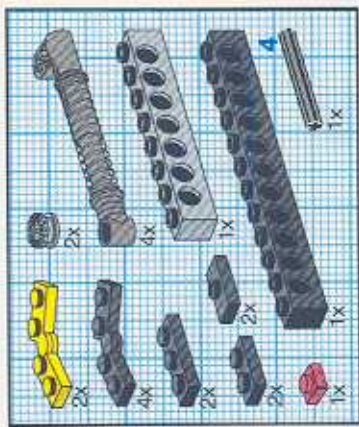
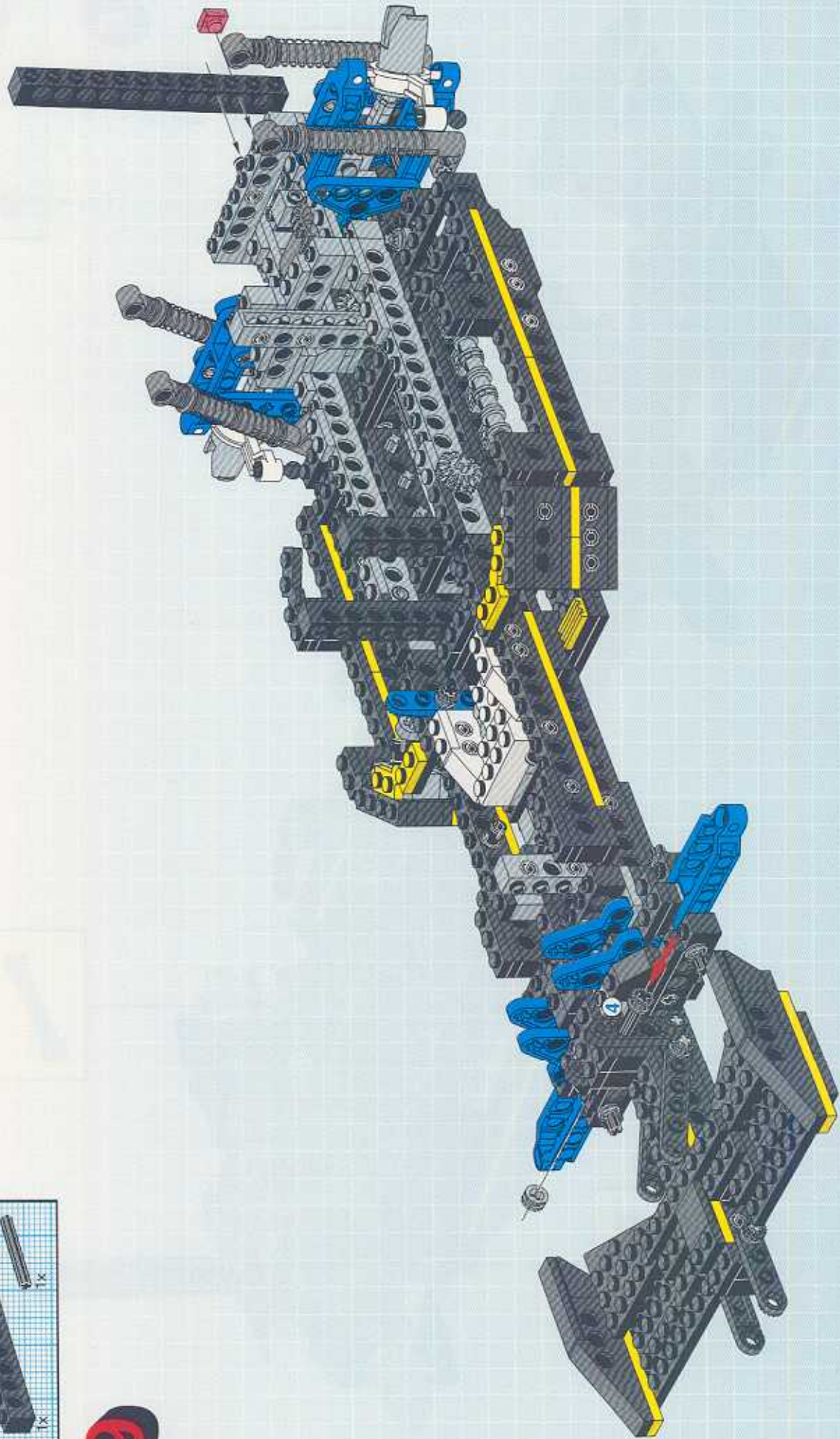

19

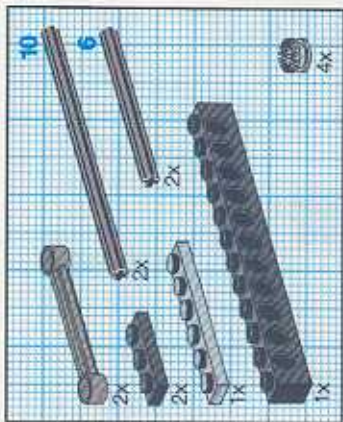

20

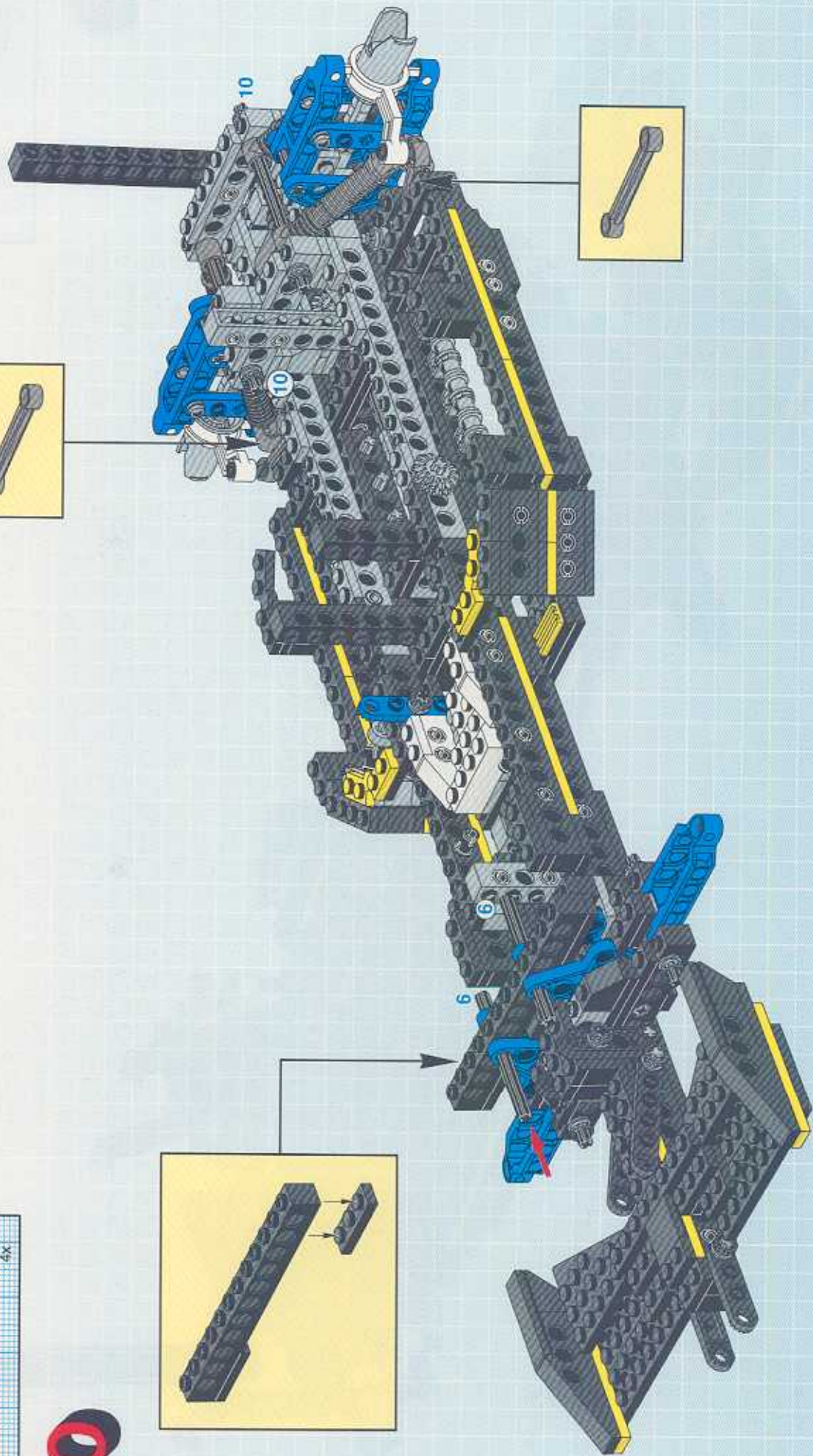
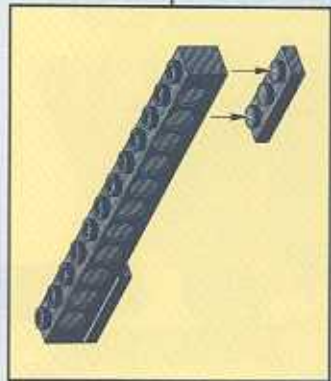



1

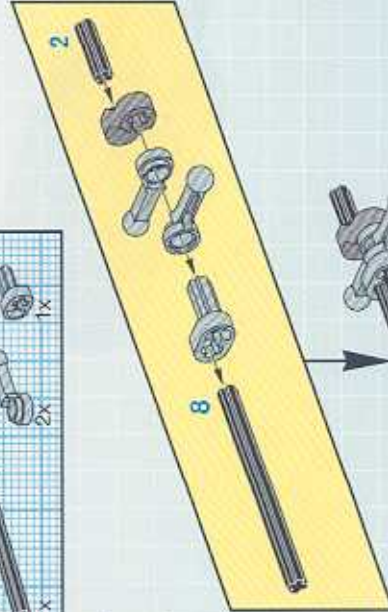

2

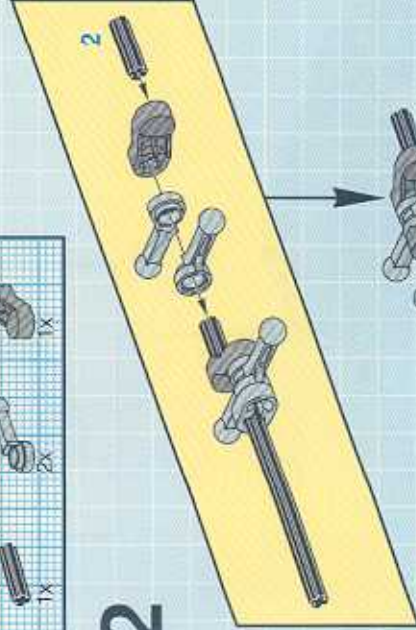

3

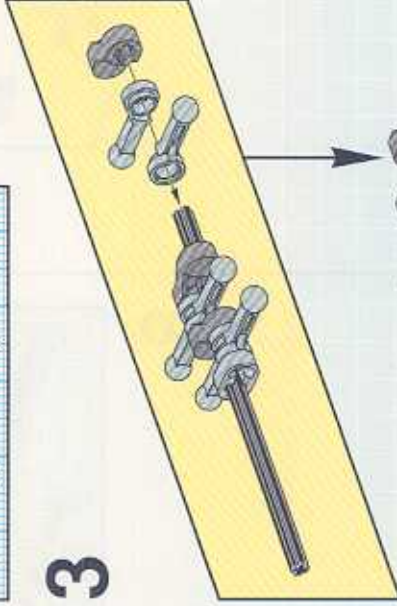

4

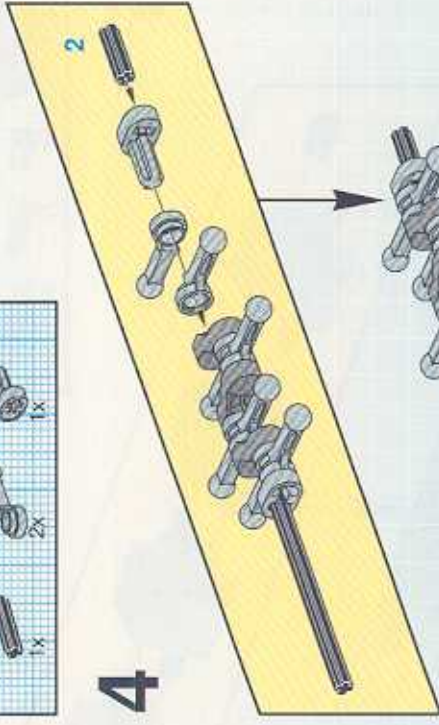

5

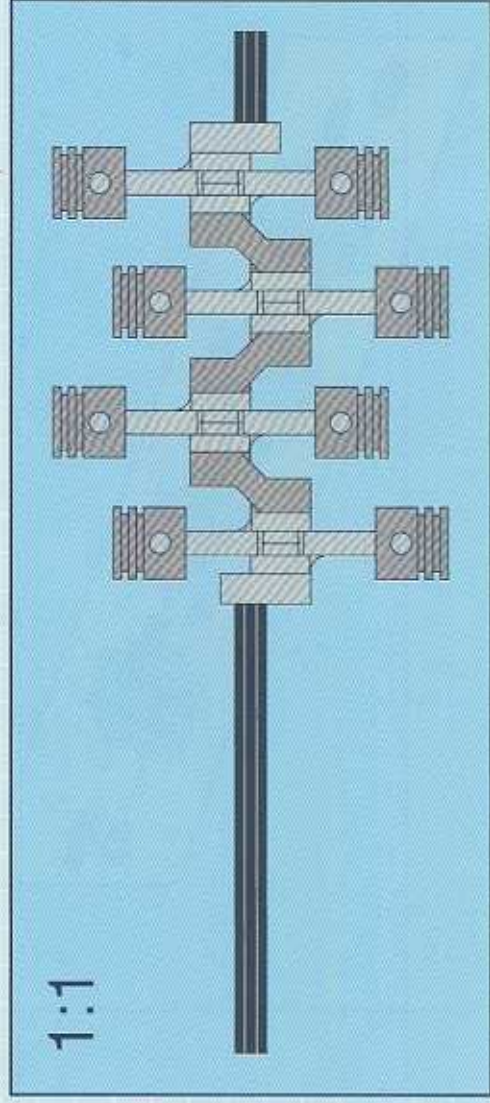
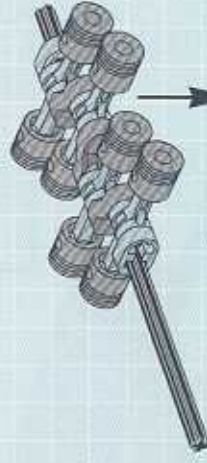

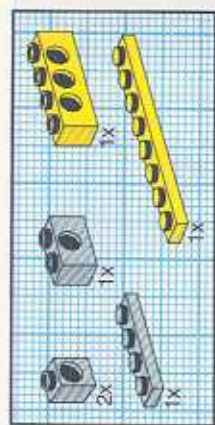

8

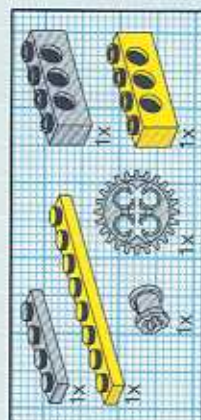
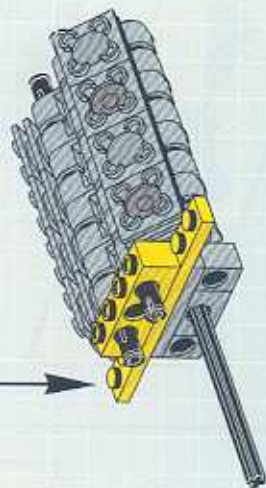

9

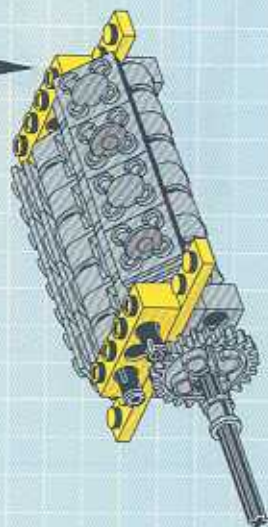
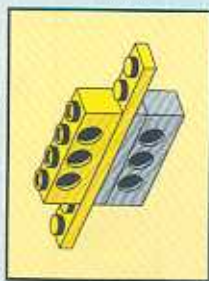

6

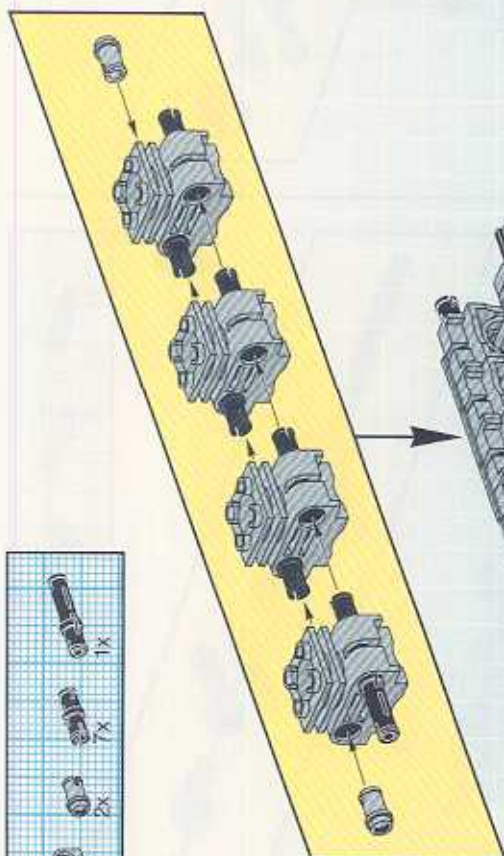

7

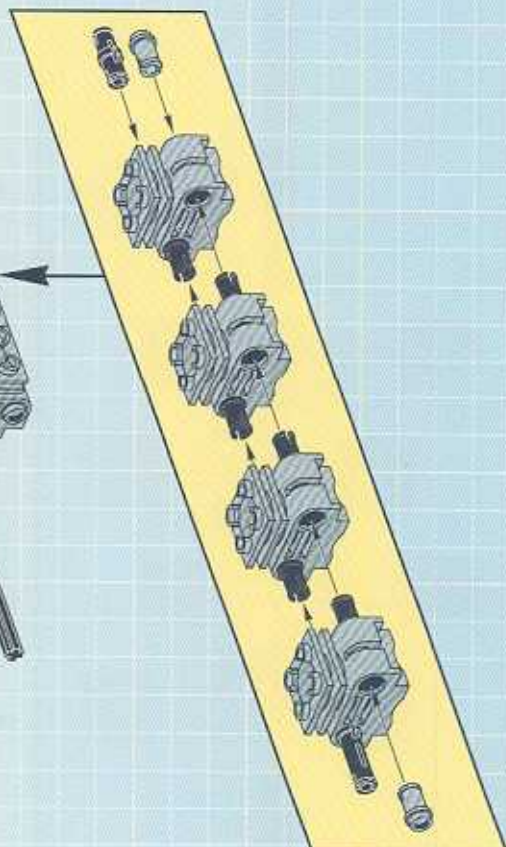
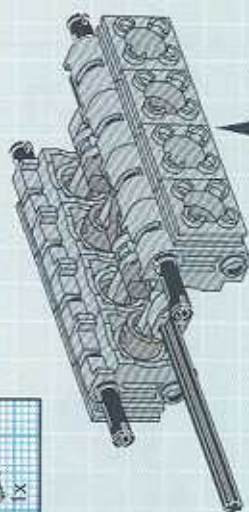

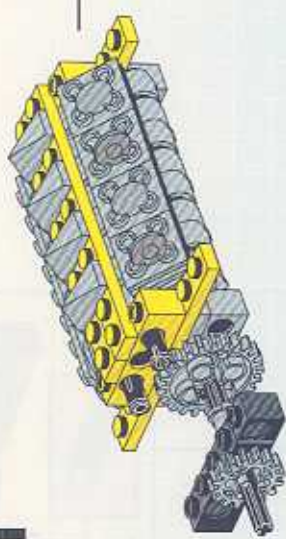
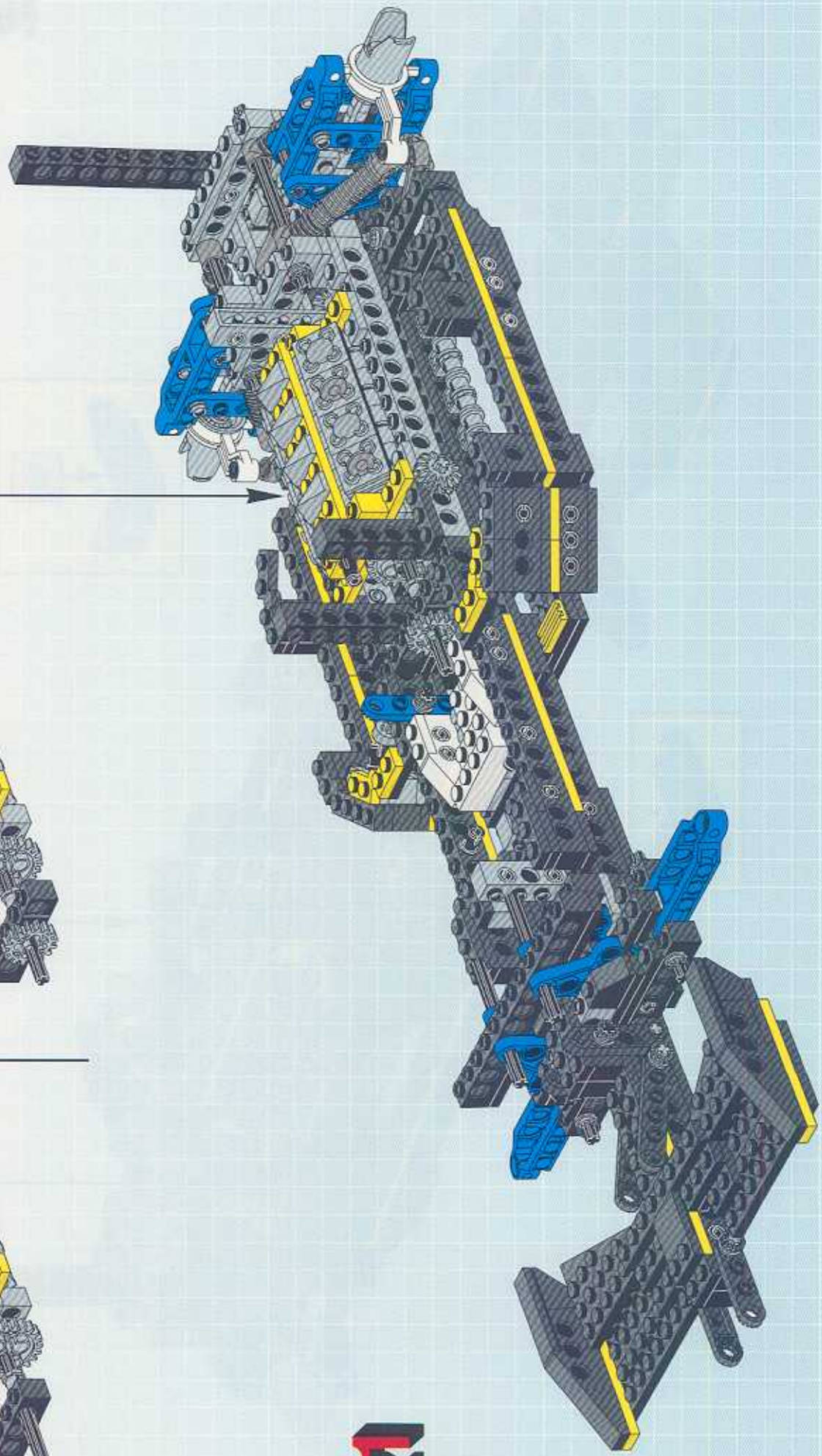

11

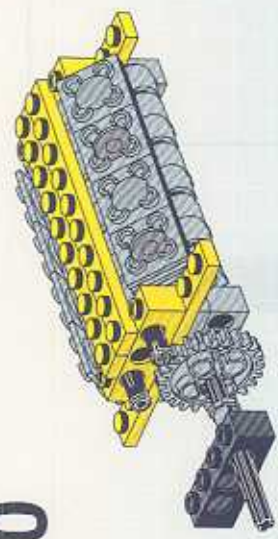

10

21

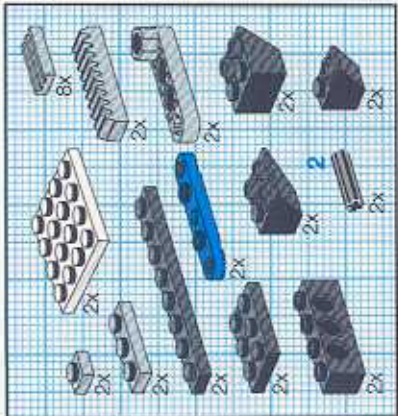
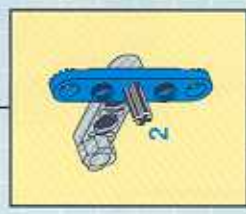
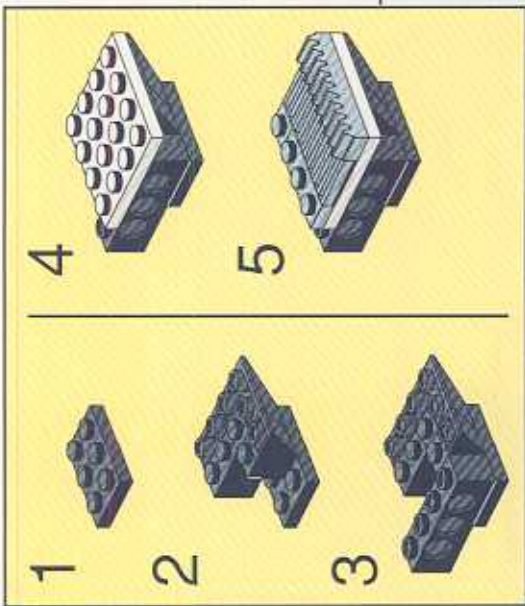
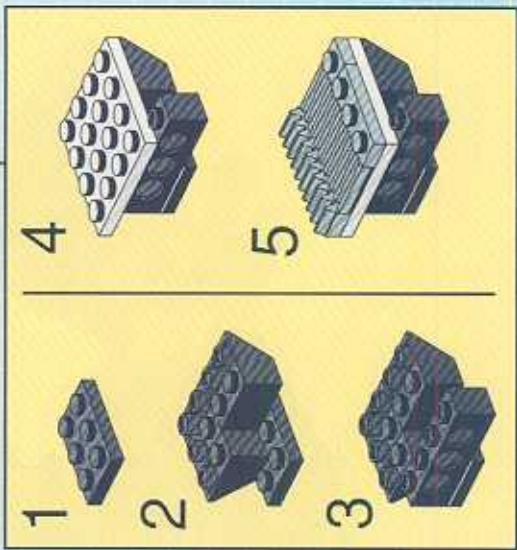
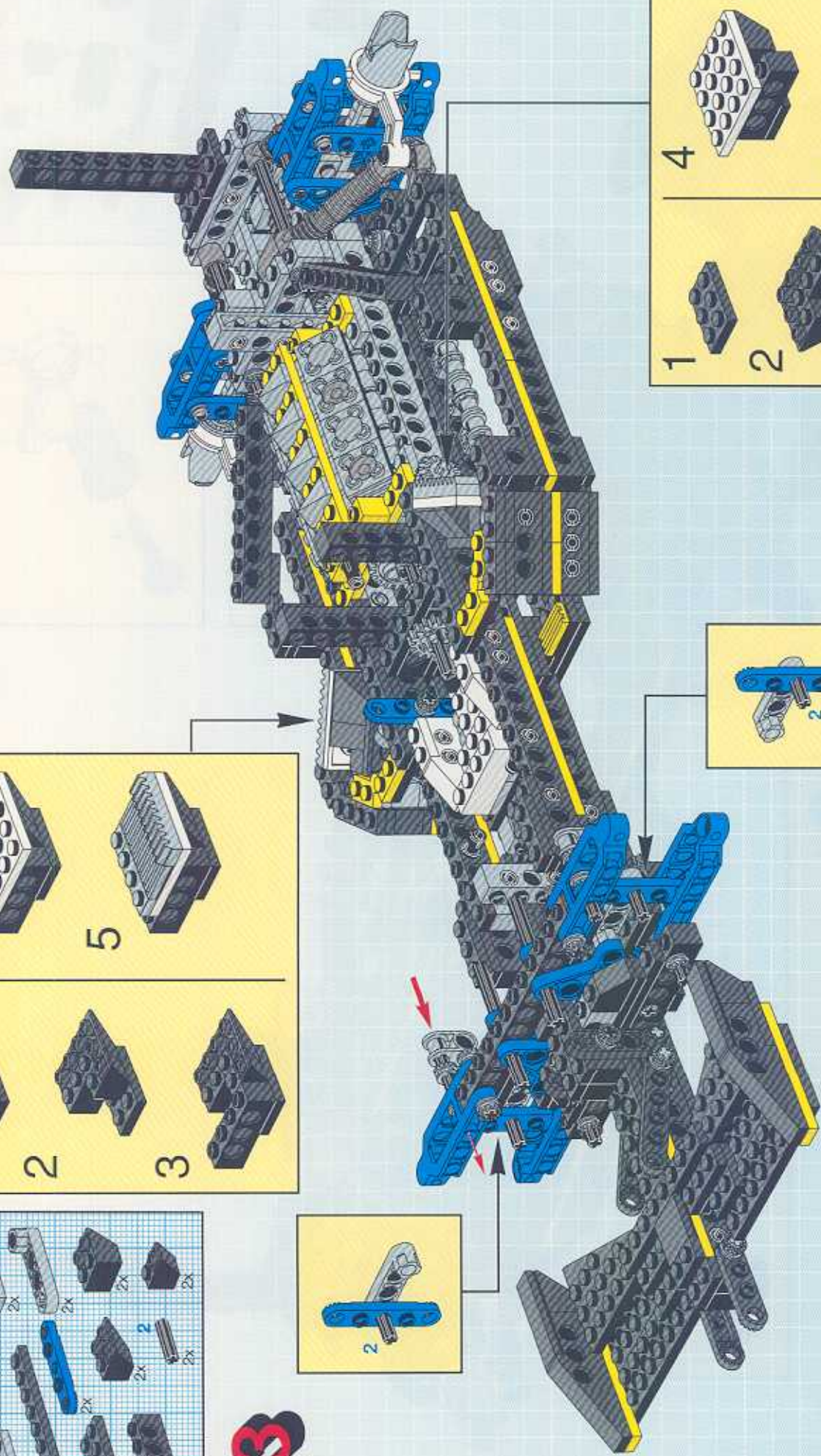

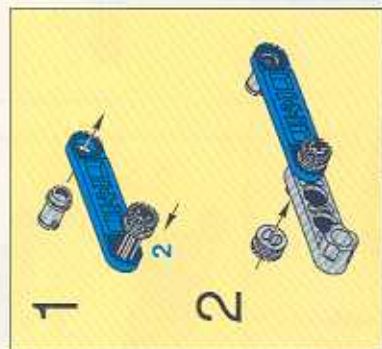
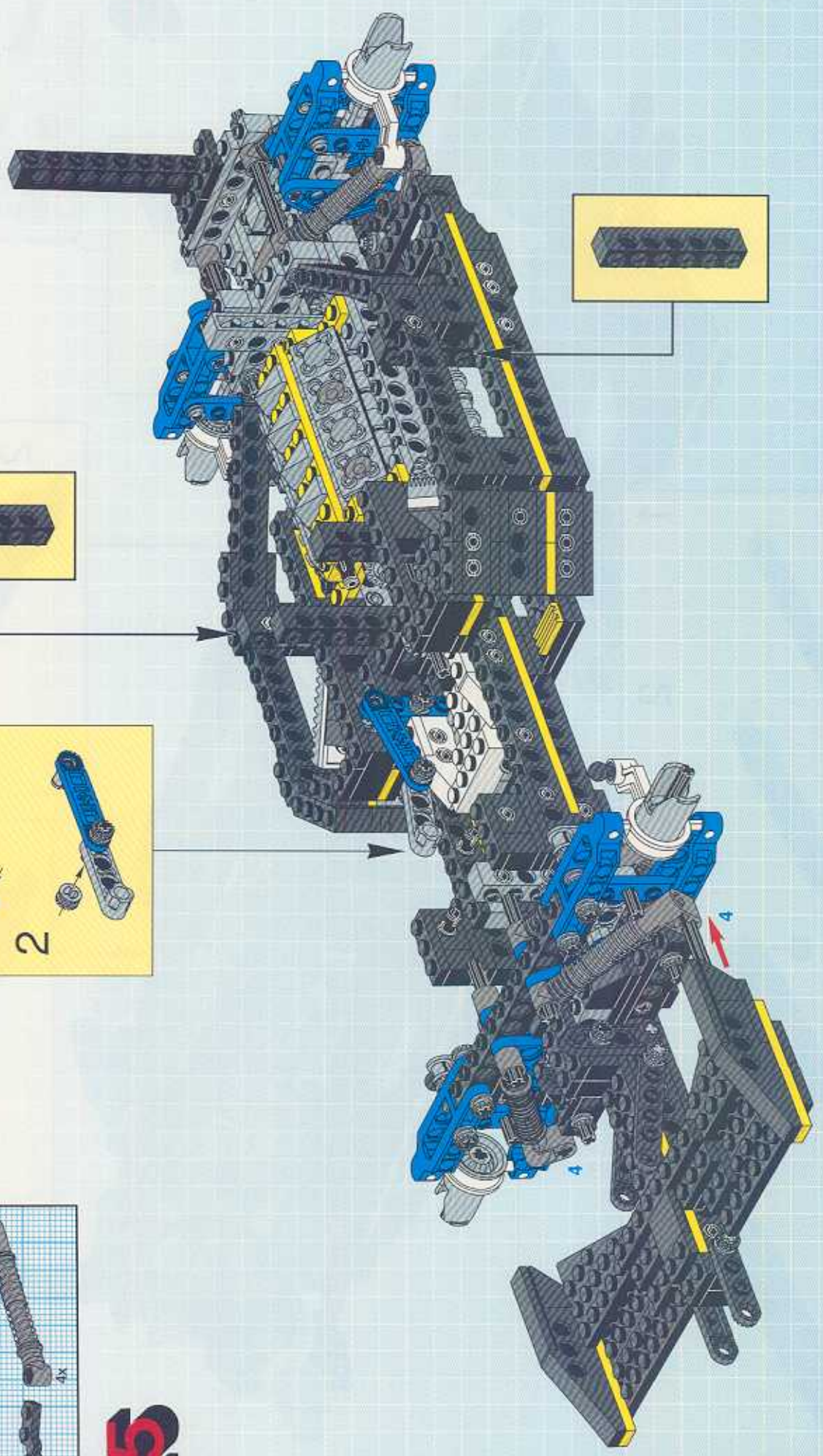

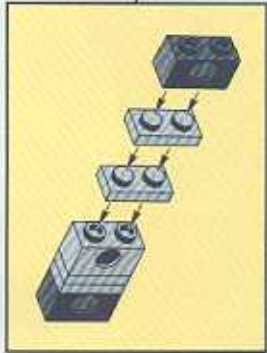
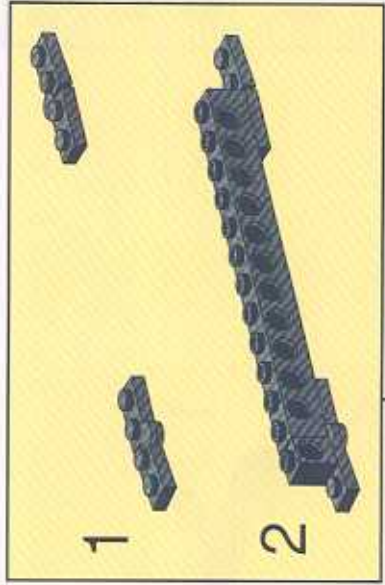
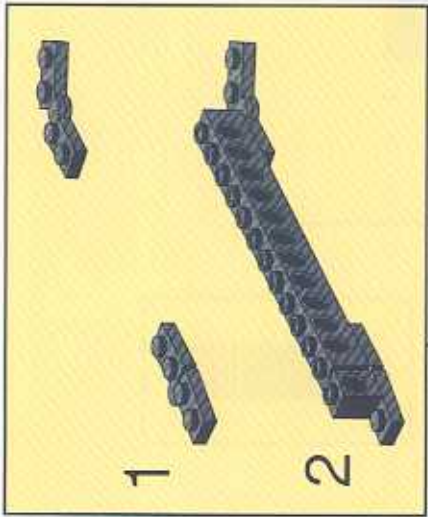

26

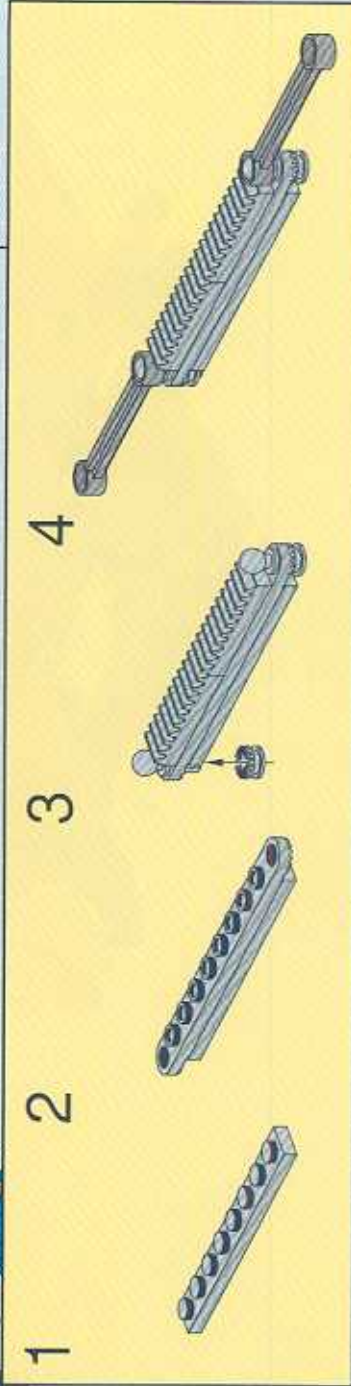
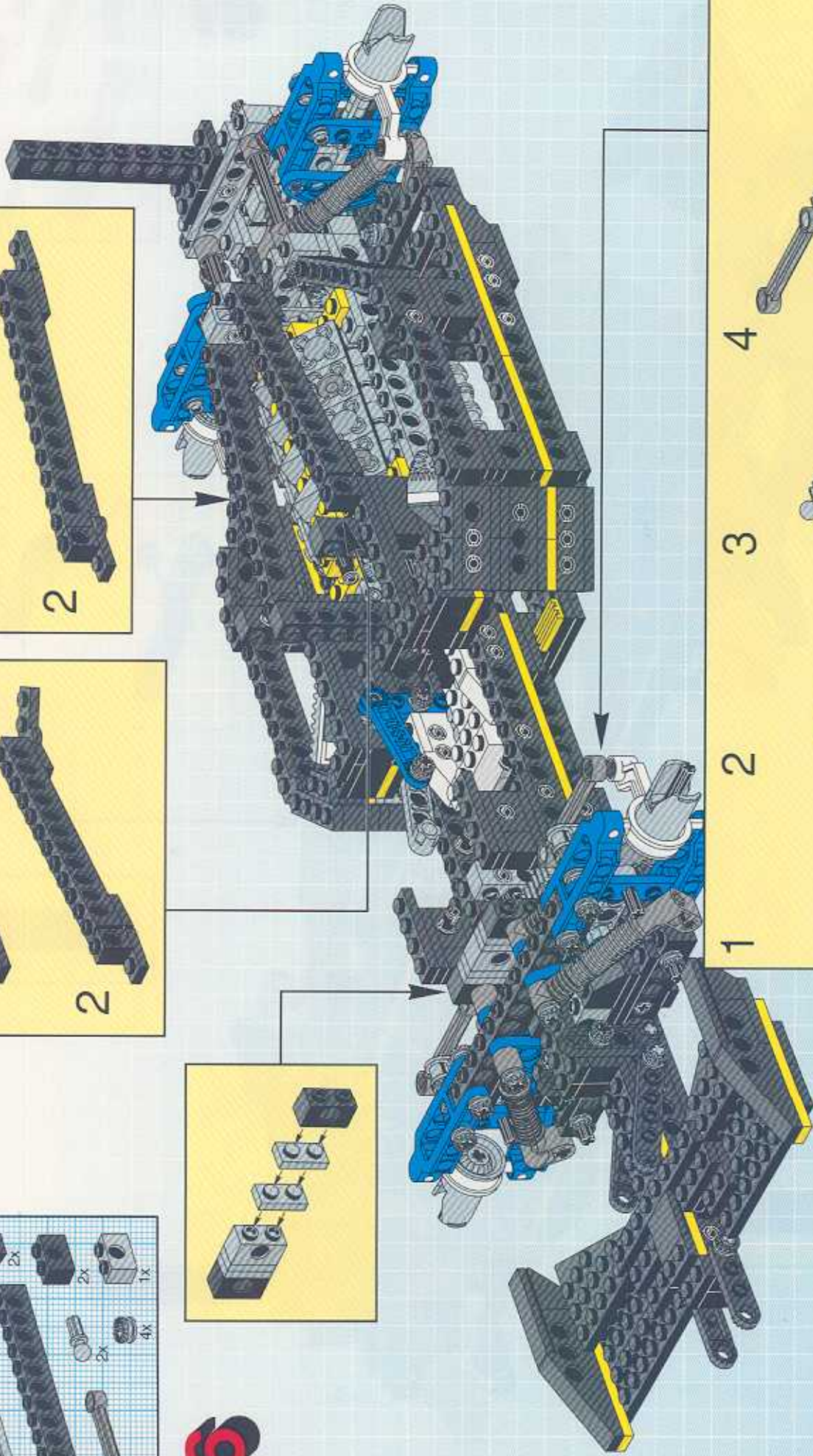

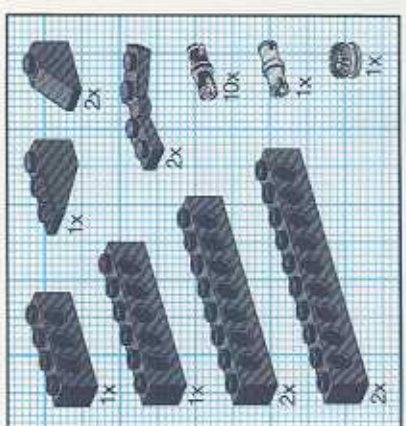
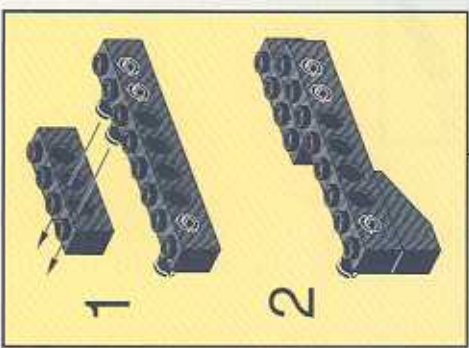
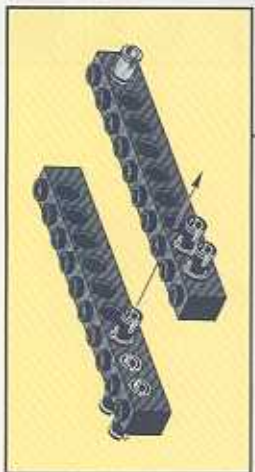
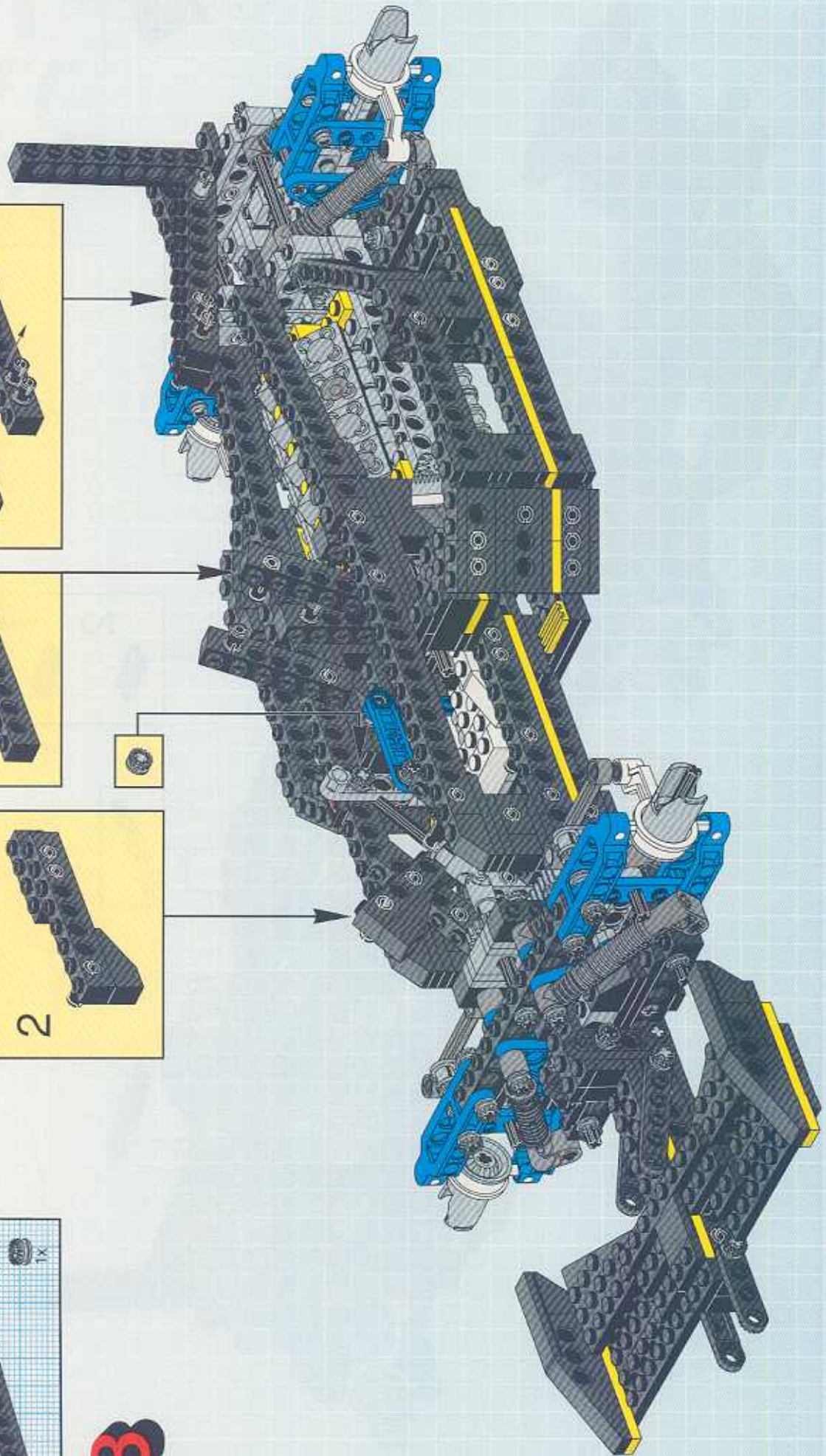

28

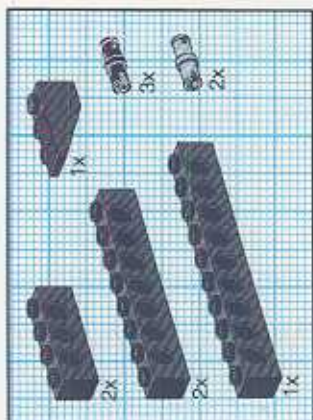
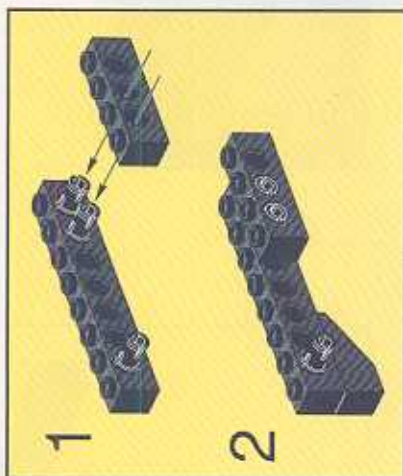
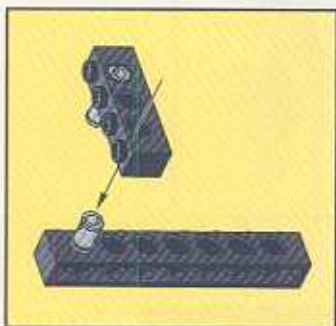
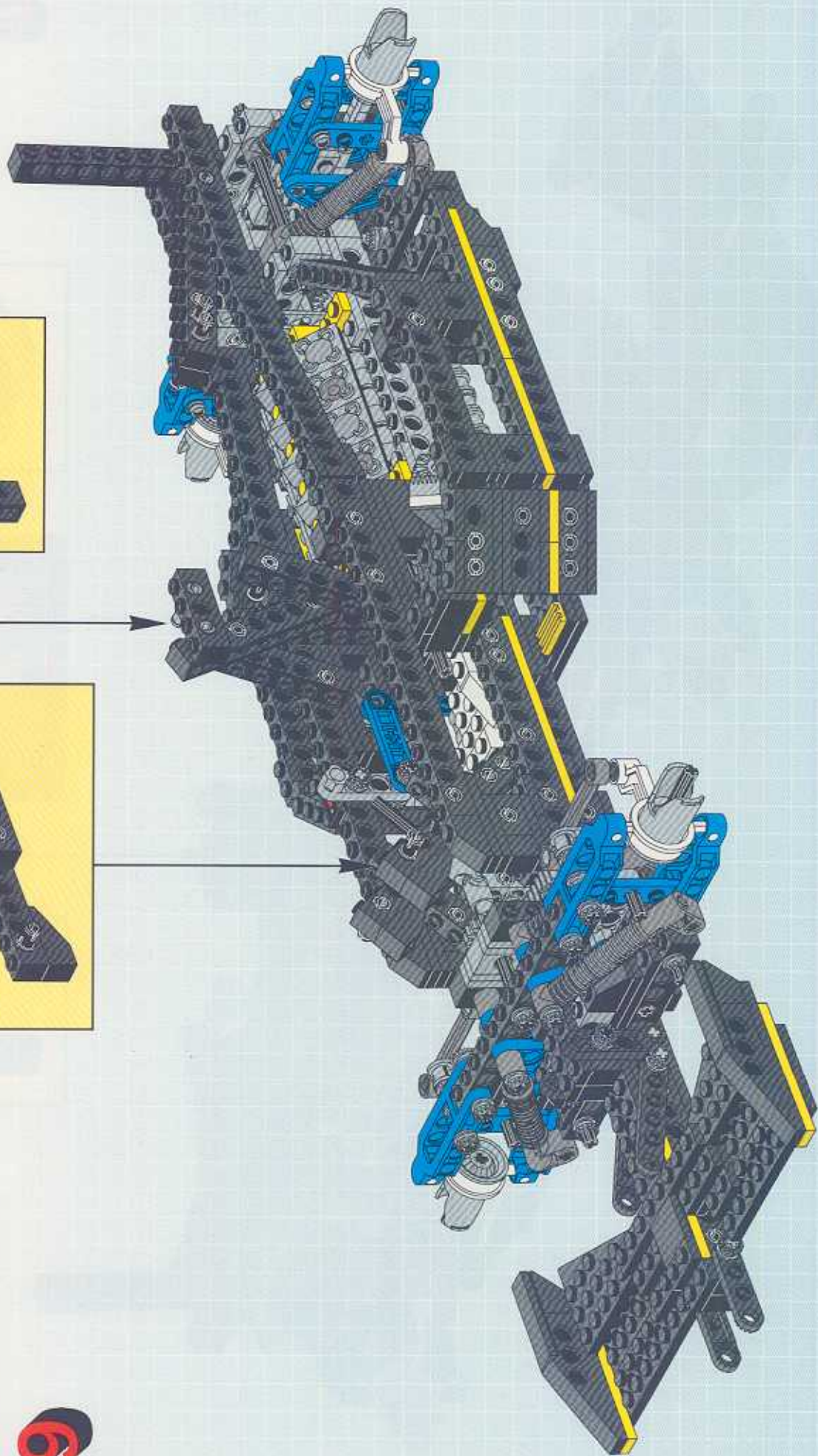

29

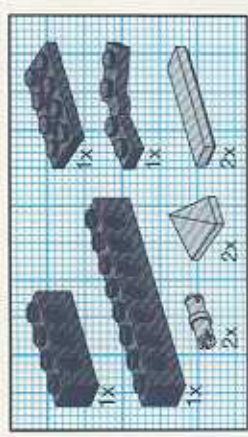
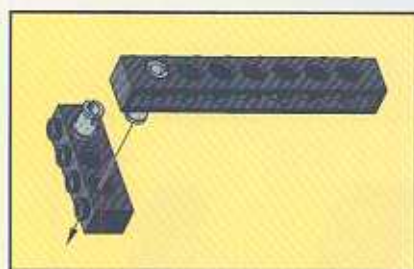
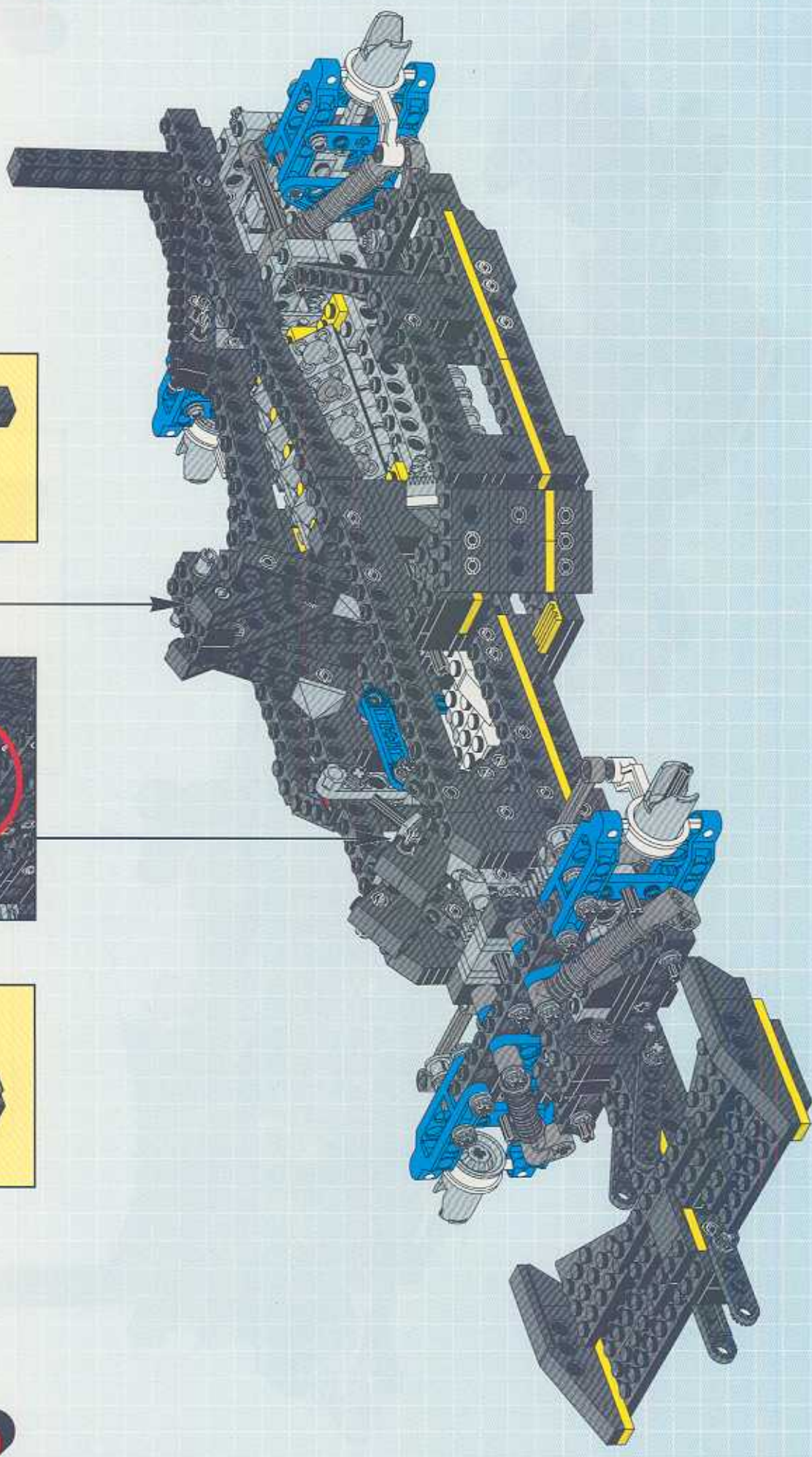

30



1



2



3

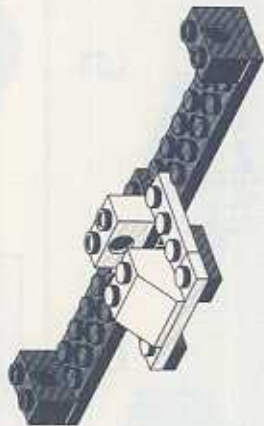

4

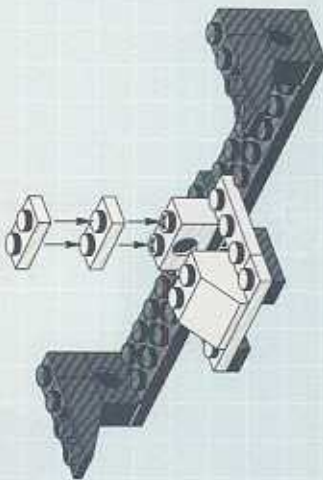

5



6

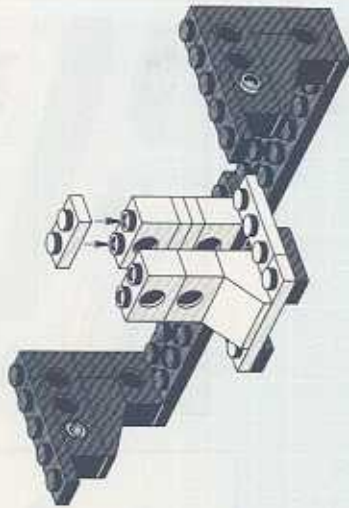

7

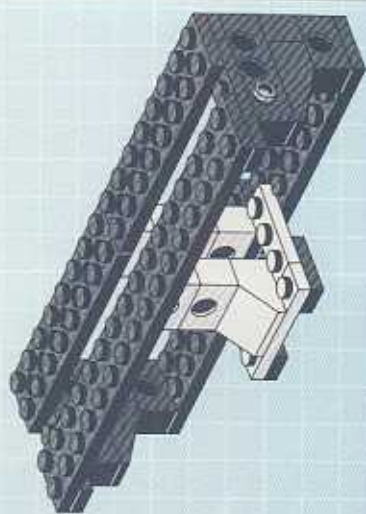



8

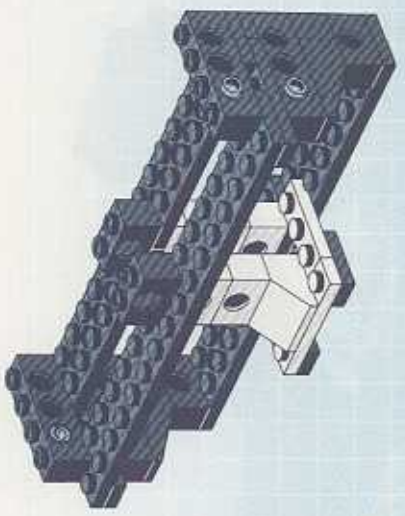

9

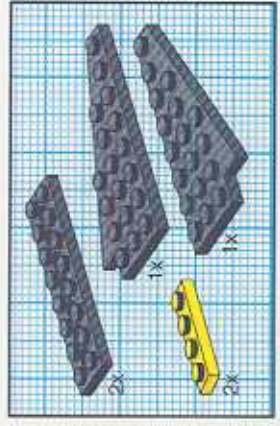

10

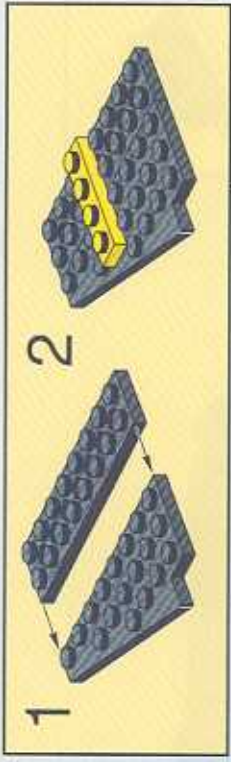

1



2

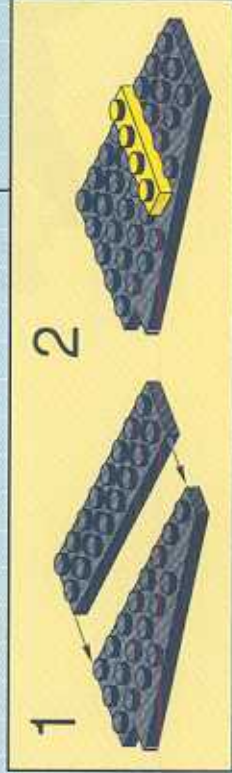
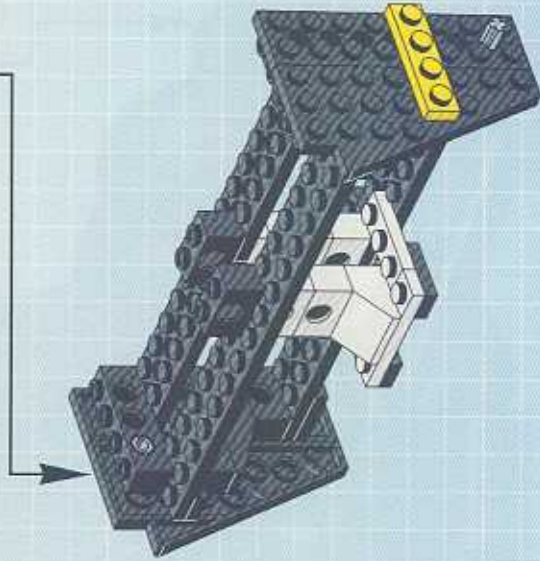

1

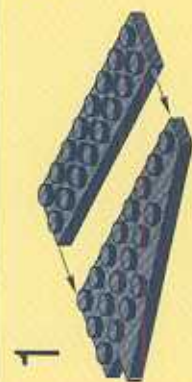

2



11

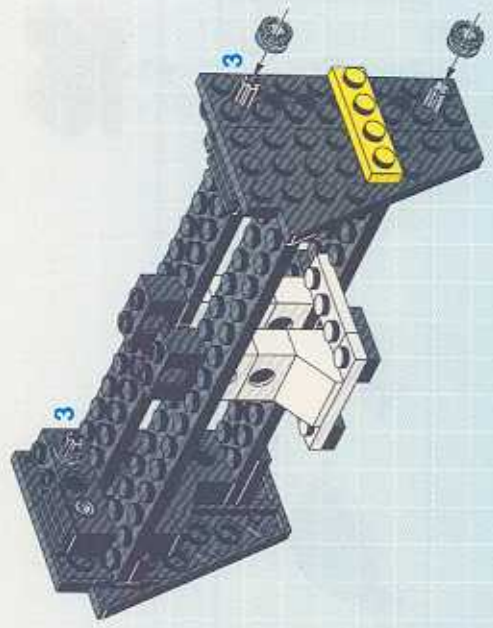

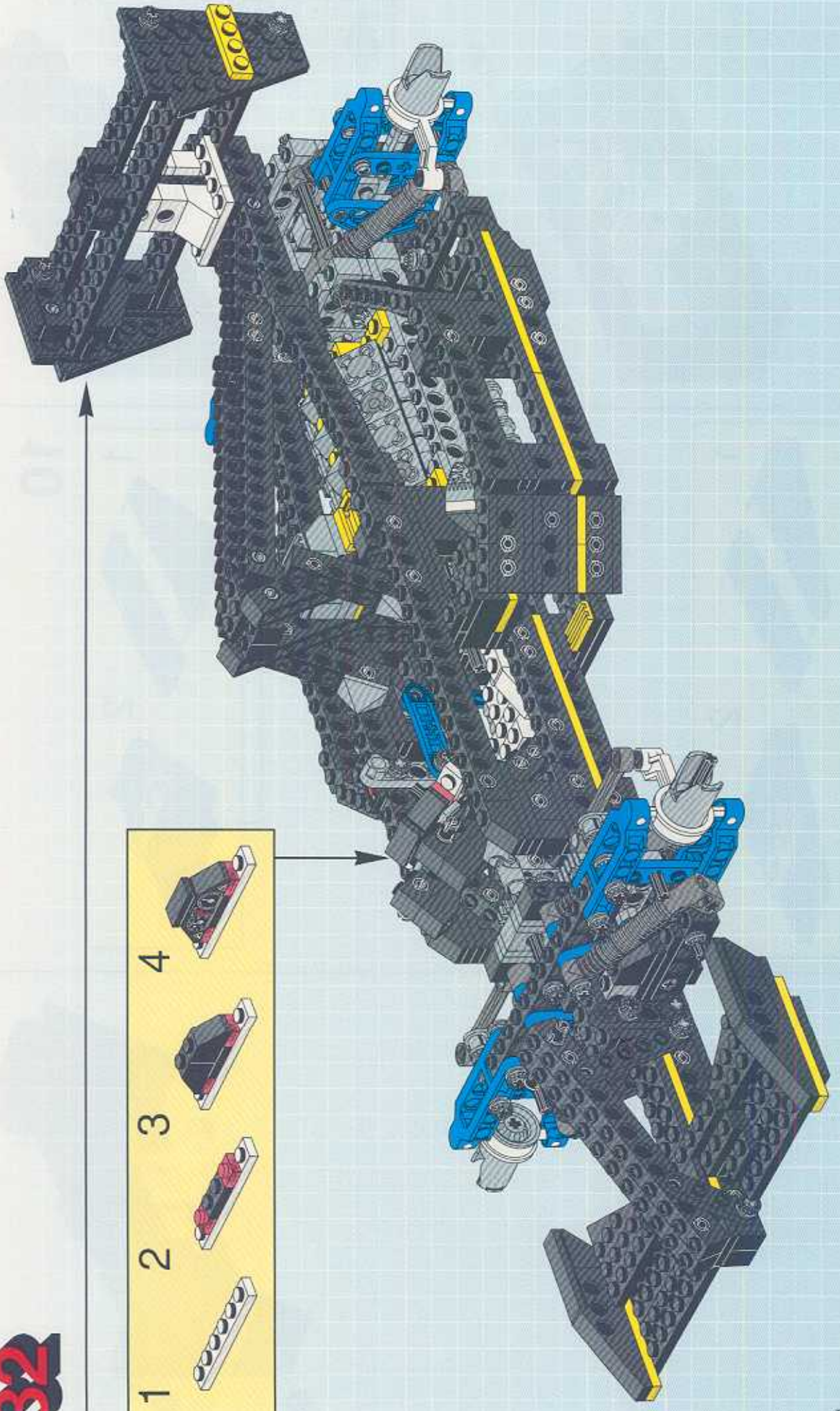

- 1
- 2
- 3
- 4

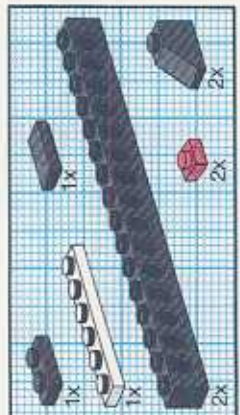

32

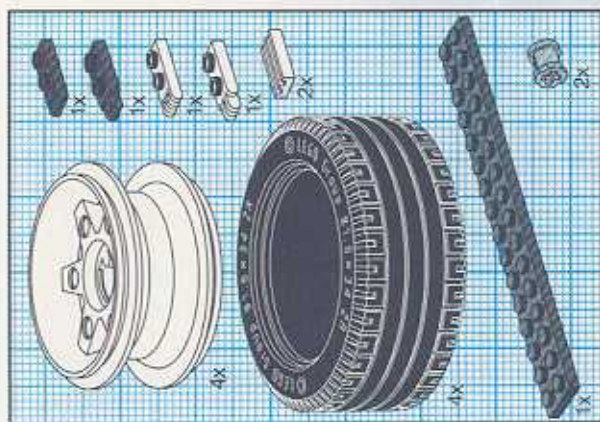
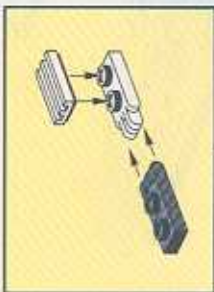
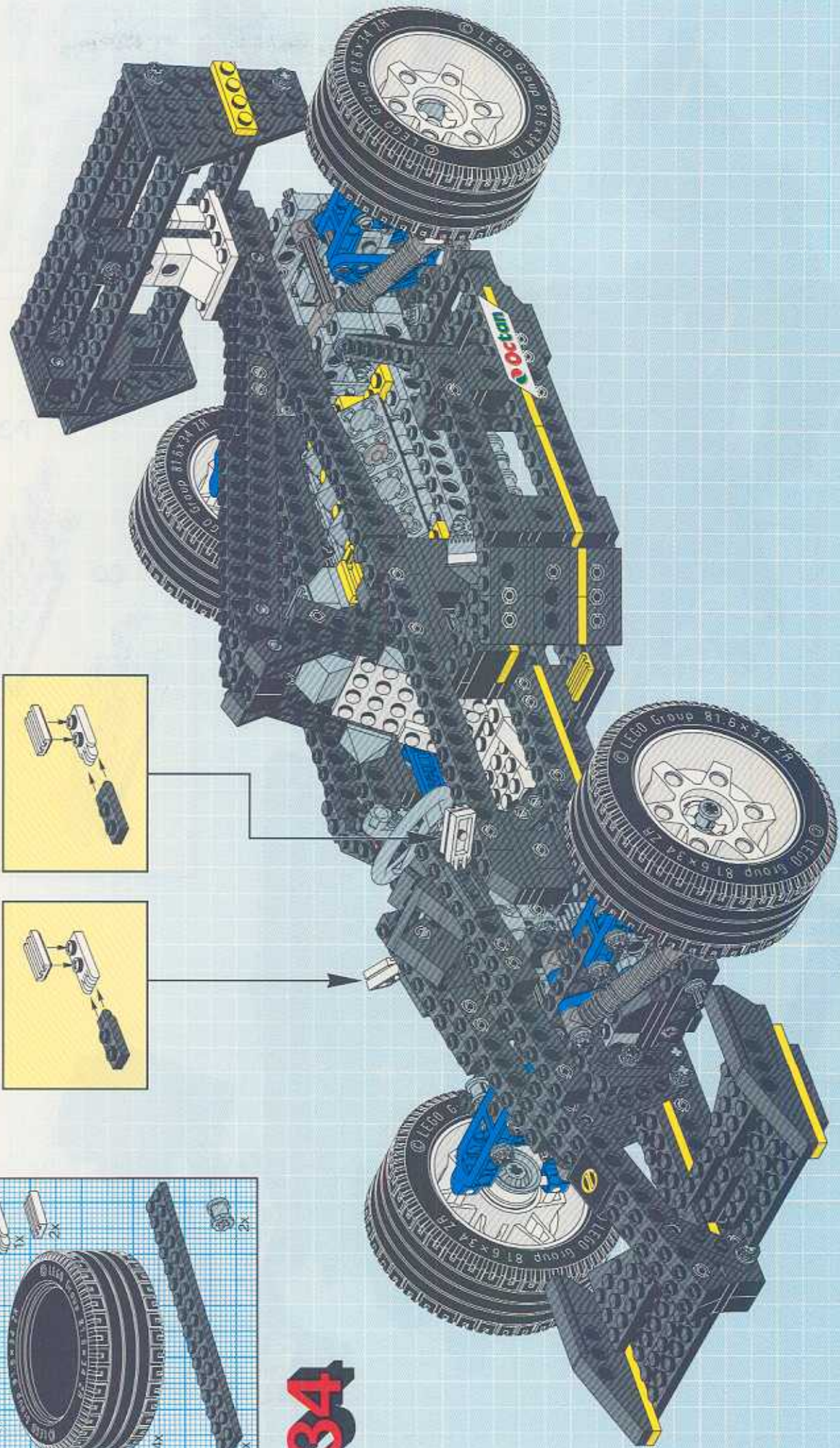

34





Technic

8880

