



6225825

 LEGO.com



1



2

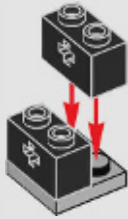

3

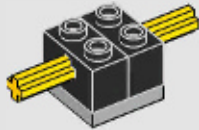

4

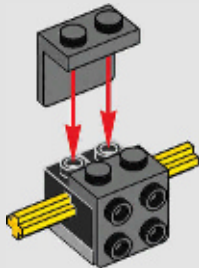

5

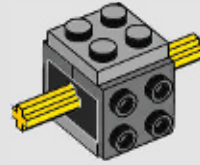

6

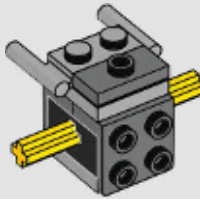

7

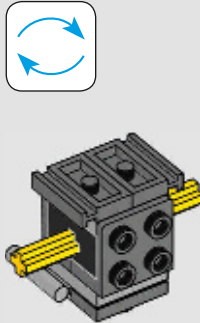

8

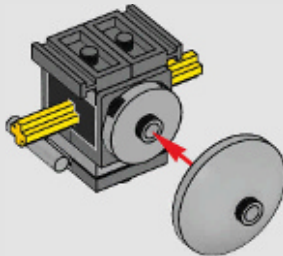

9

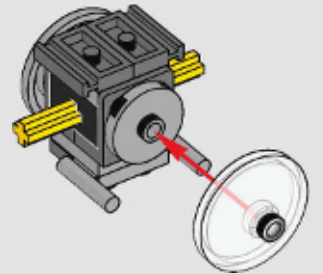

10

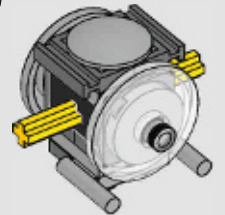

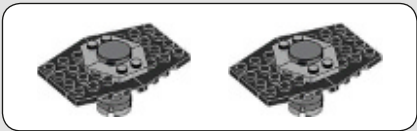

11

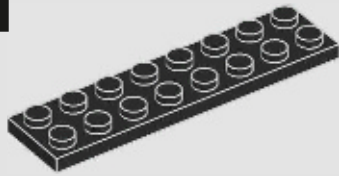

12

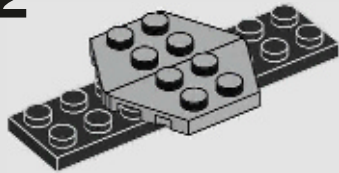

13

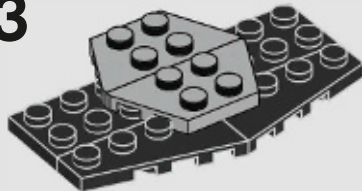

14

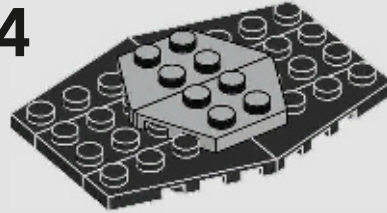

15

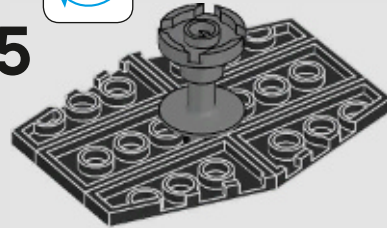

16

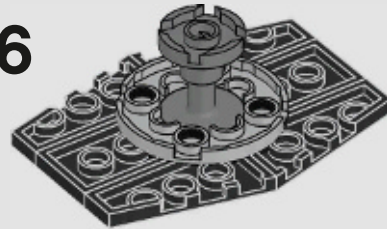

17

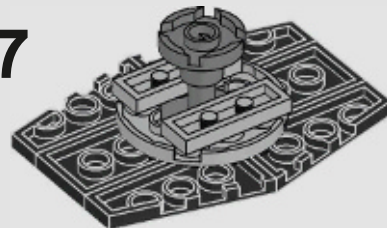

18

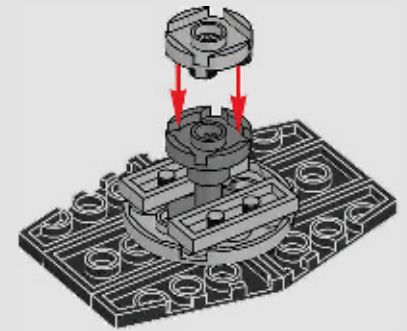

19

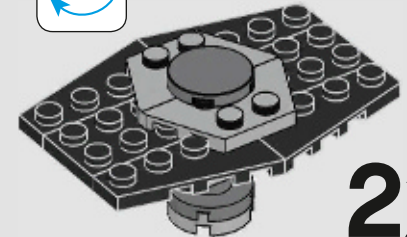

2x

20

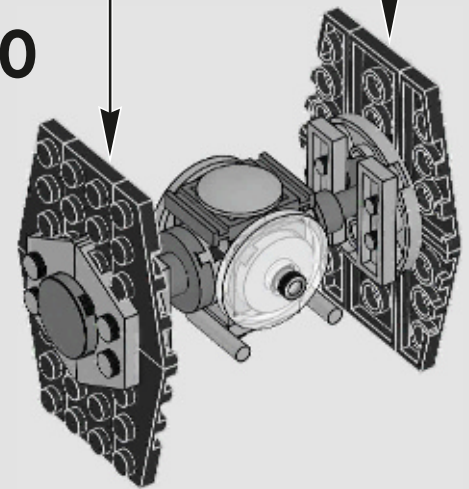

LEGO.com/service

LEGO and the LEGO logo are trademarks of the LEGO Group.

©2018 The LEGO Group.

© & ™ Lucasfilm Ltd.

6225825