



SPEED CHAMPIONS



75872

Audi R18 e-tron quattro



[LEGO.com/speedchampions](https://www.lego.com/speedchampions)

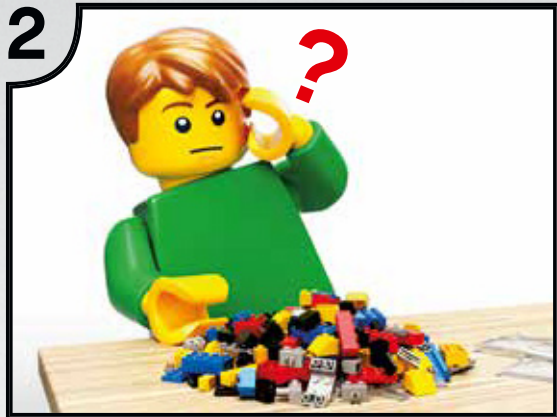

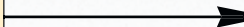
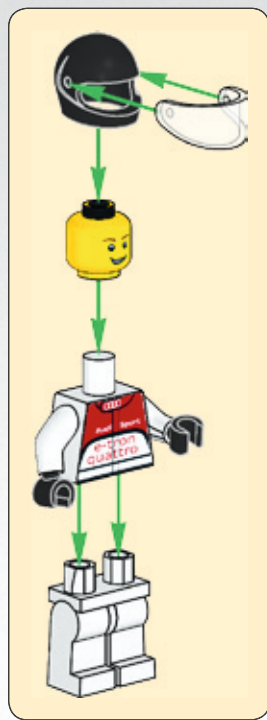



1x



1x

1

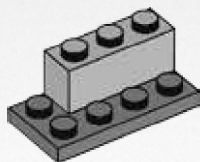

1x

2

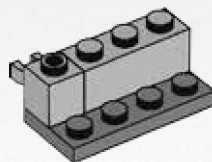



2x

3



2x

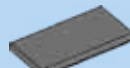
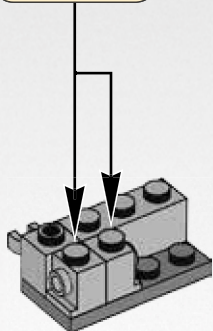

1x

4

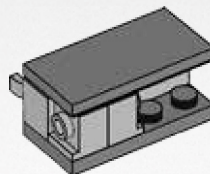



2x

5

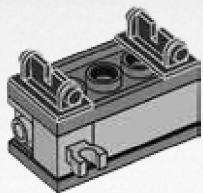
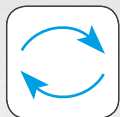

6



1x

6

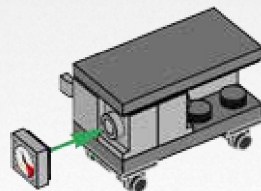
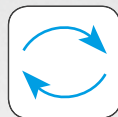

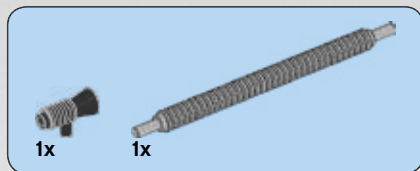

7

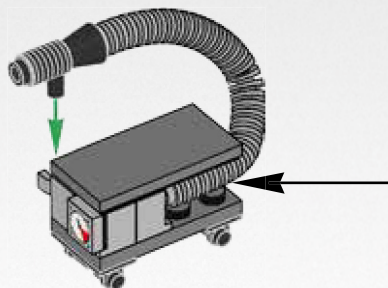
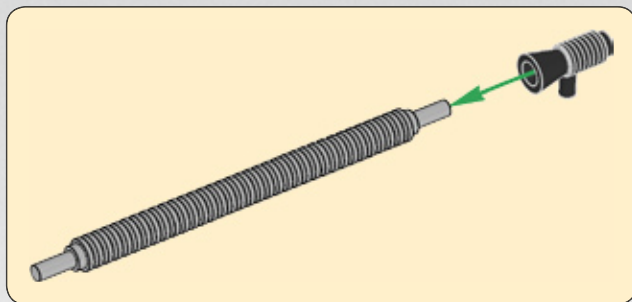

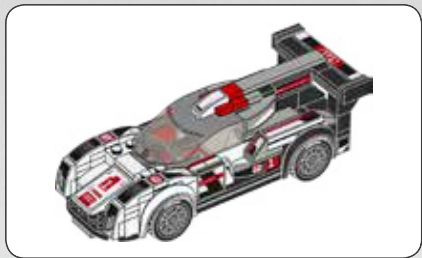

1

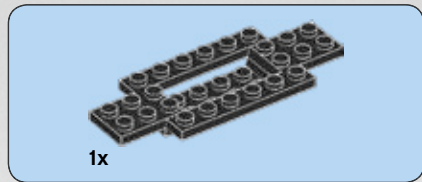
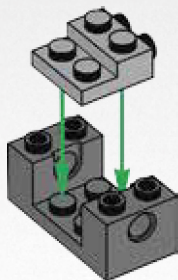

2

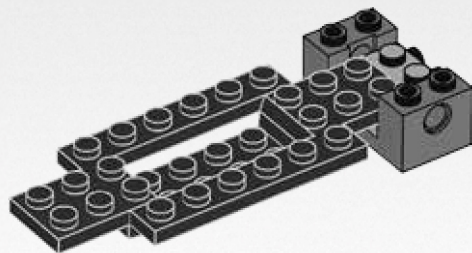



1x



1x

3

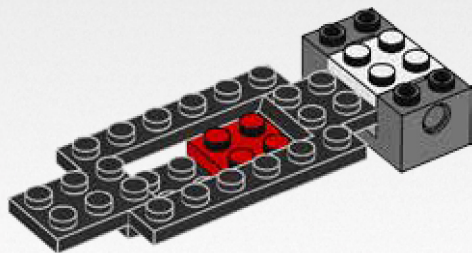

1x



1x

4

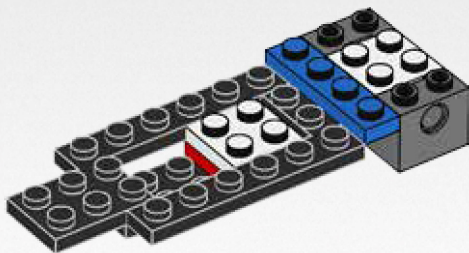



2x



2x

5

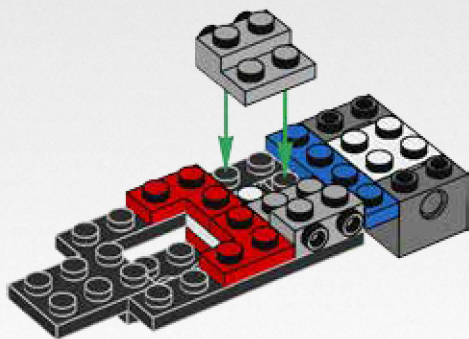

2x

6

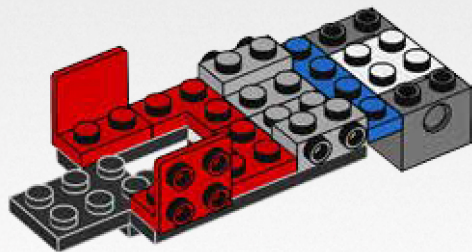



2x

7

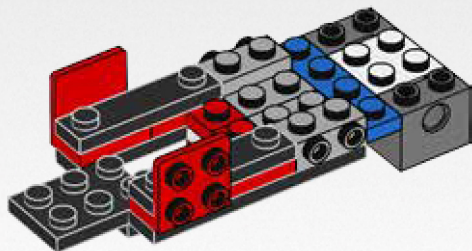

1x

8

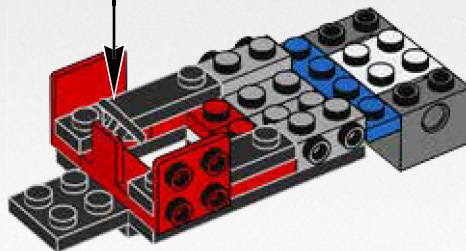

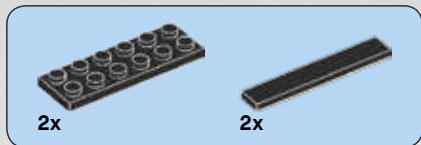

9

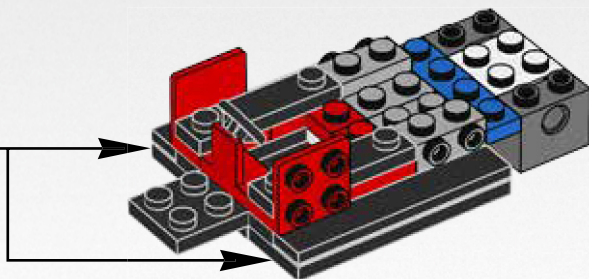
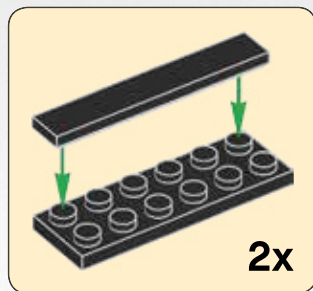



1x

10

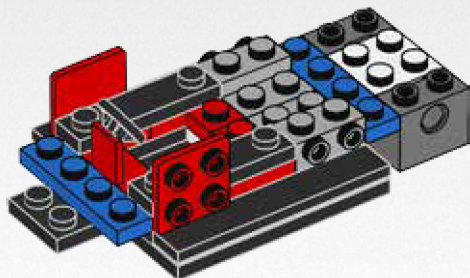



11

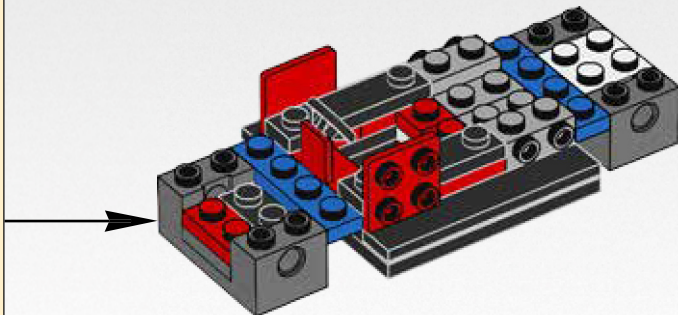
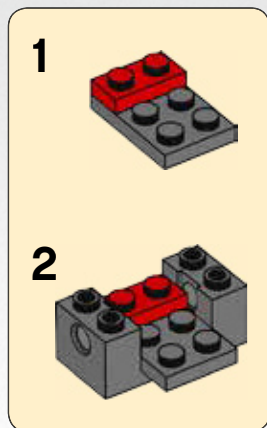

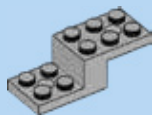

1x

12

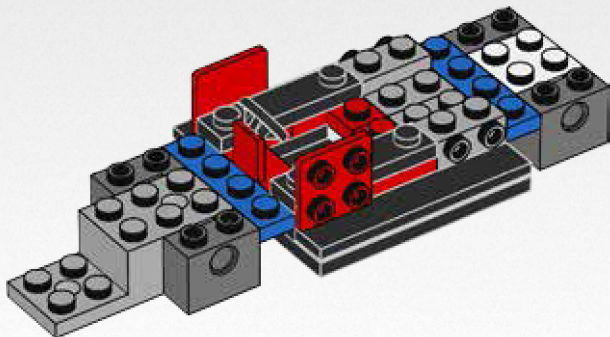



1x



1x

13

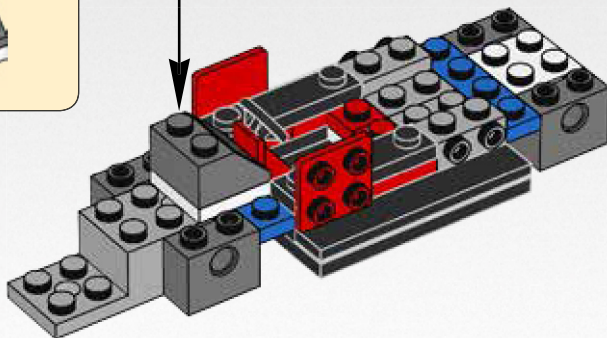
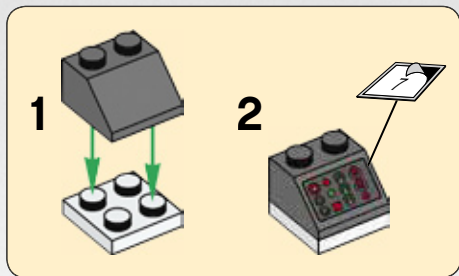



2x

14

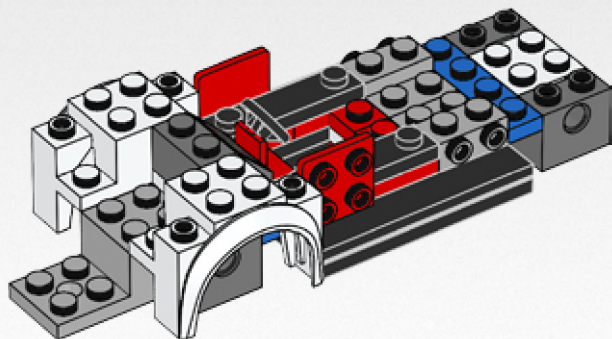



15

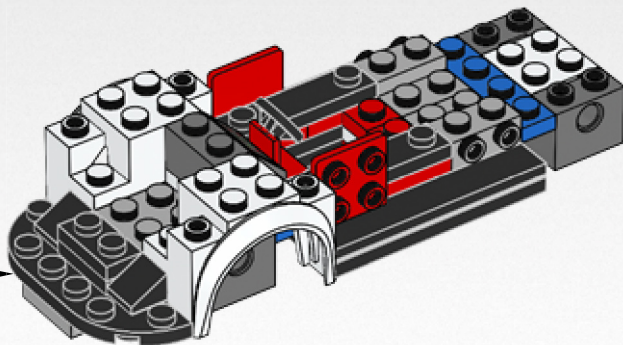



2x



2x

16

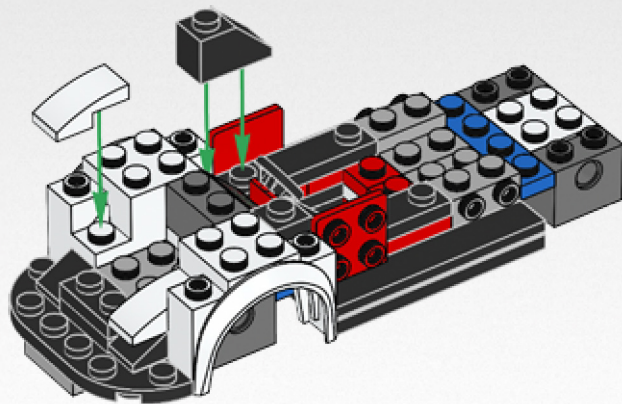

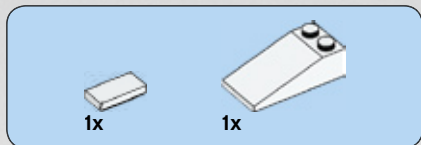

17

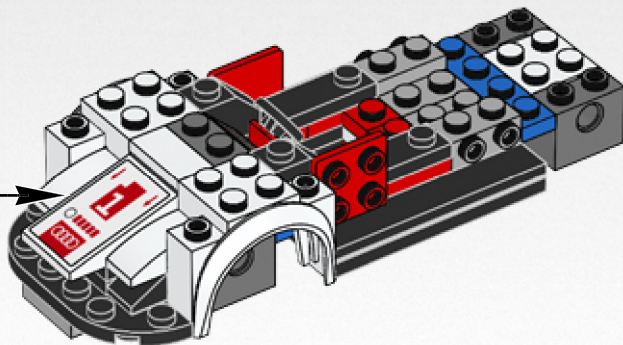
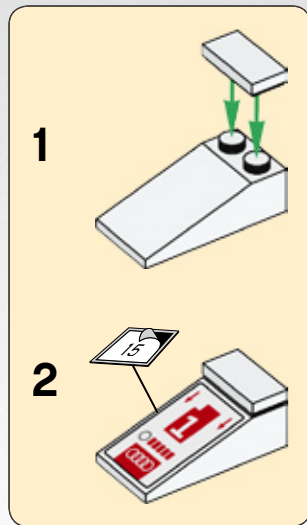



18

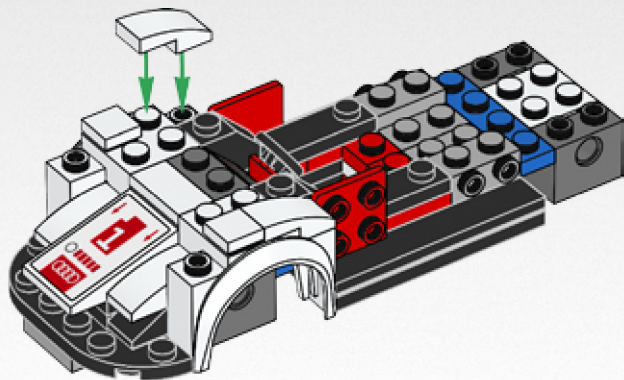



4x



2x

19

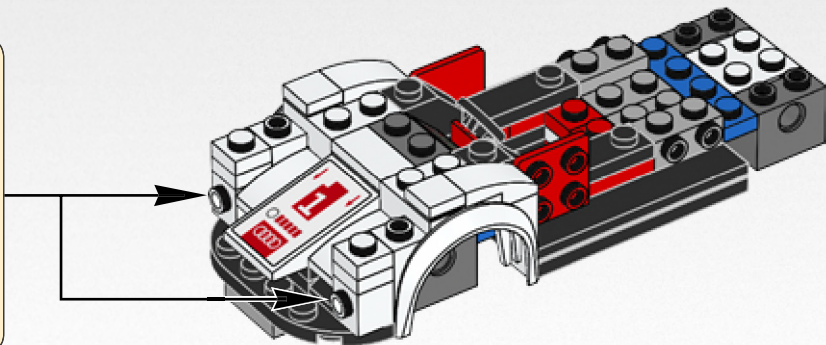
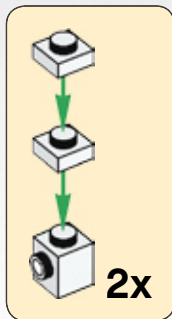



2x



2x

20

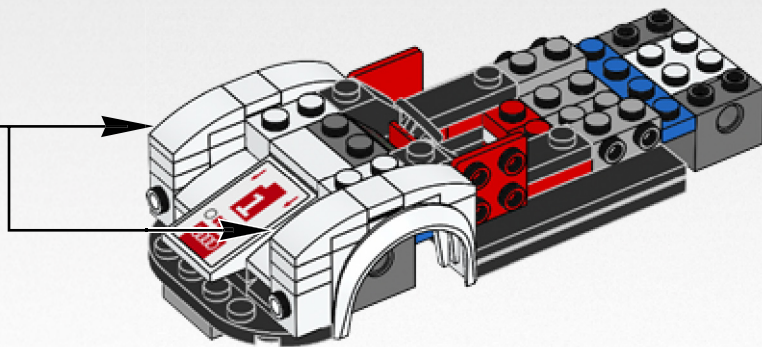
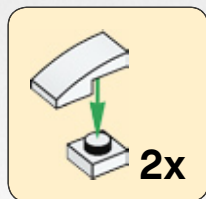

21

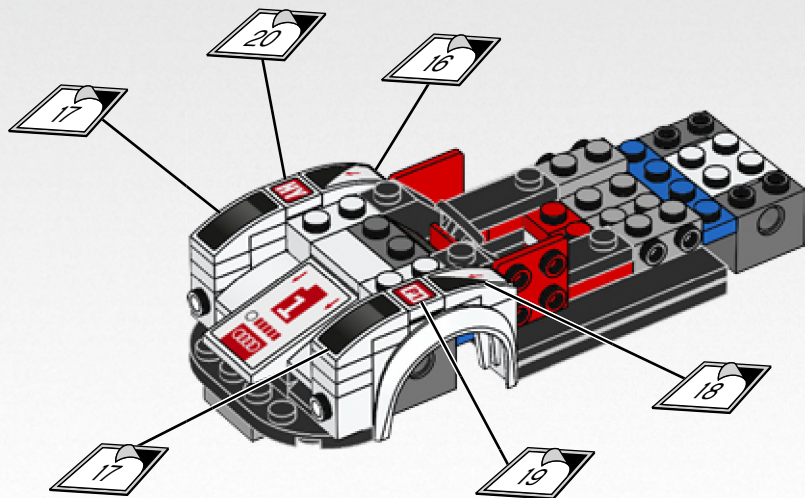



2x



2x

22

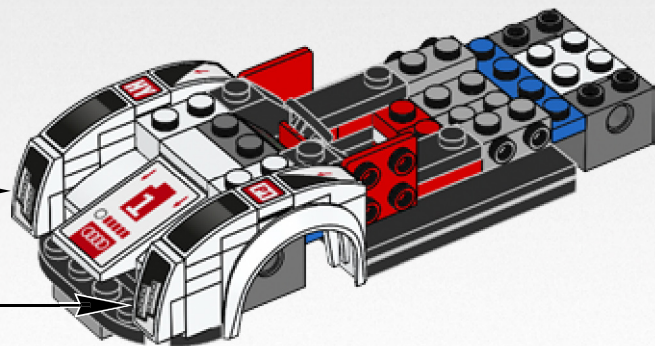
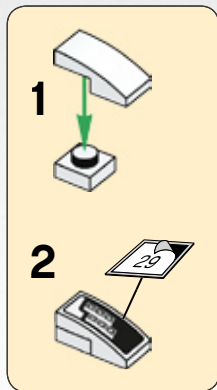
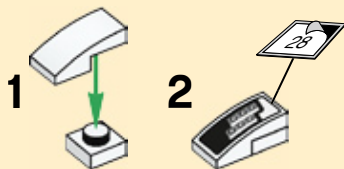

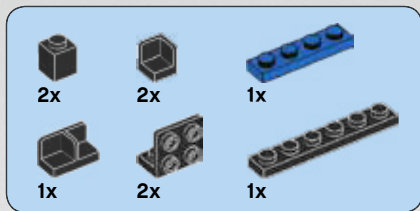

23

1

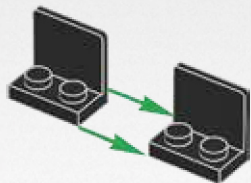

2

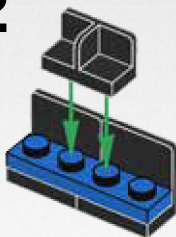

3

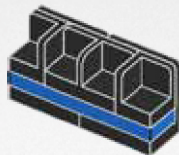

4



5

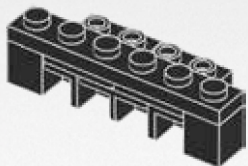

6

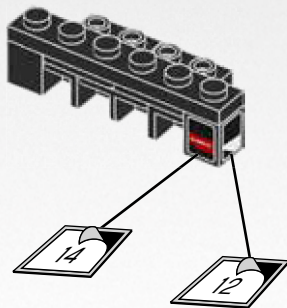

7

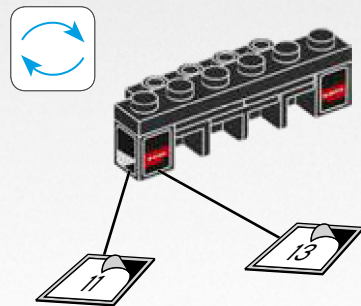

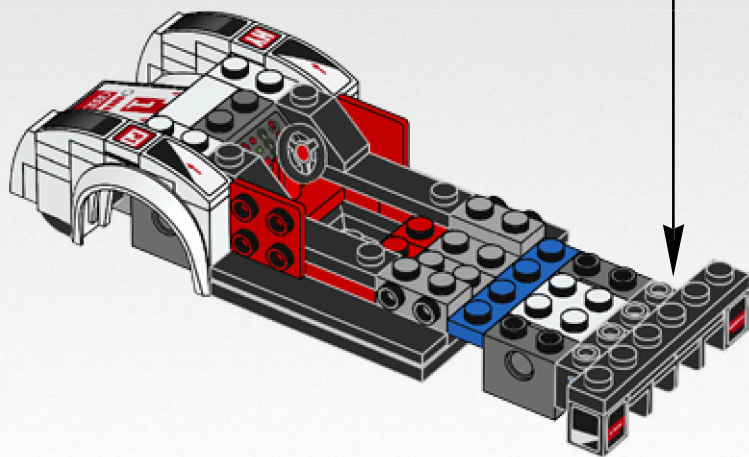



1x



1x

24

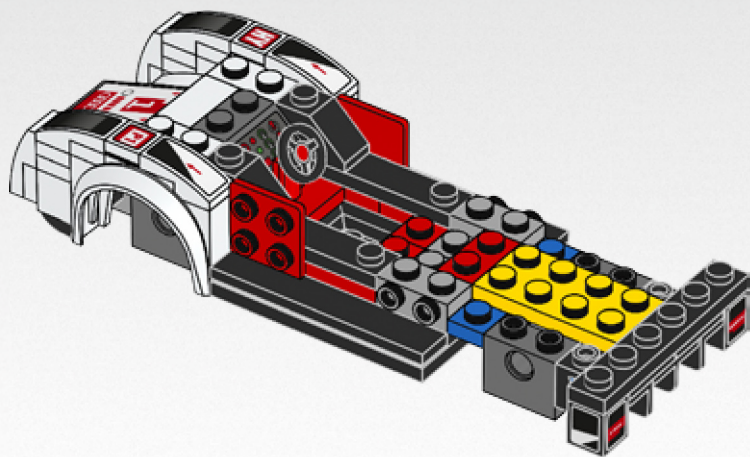



2x

25

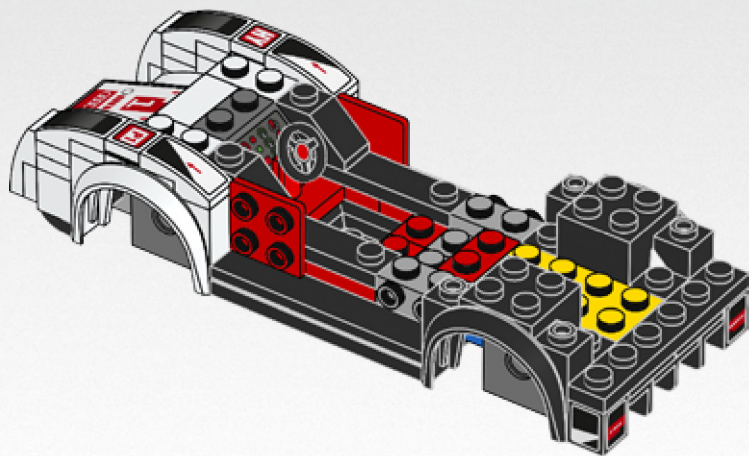



1x



2x

26

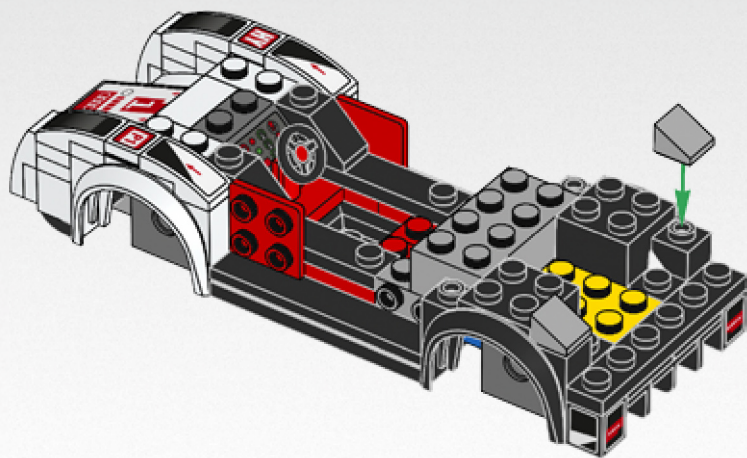



1x



1x

27

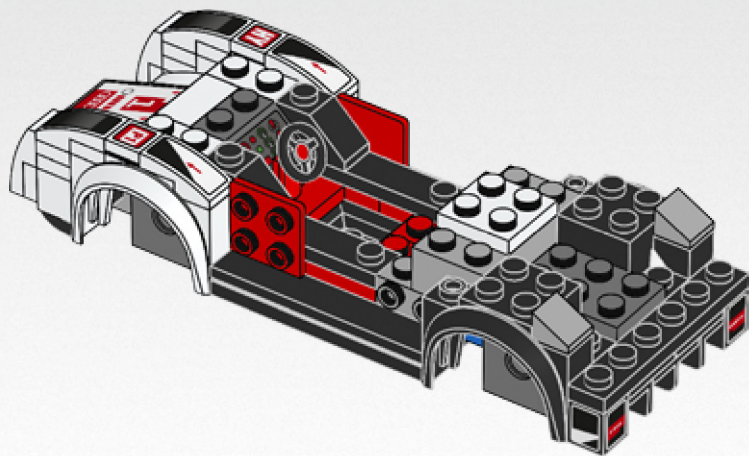



2x



2x

28

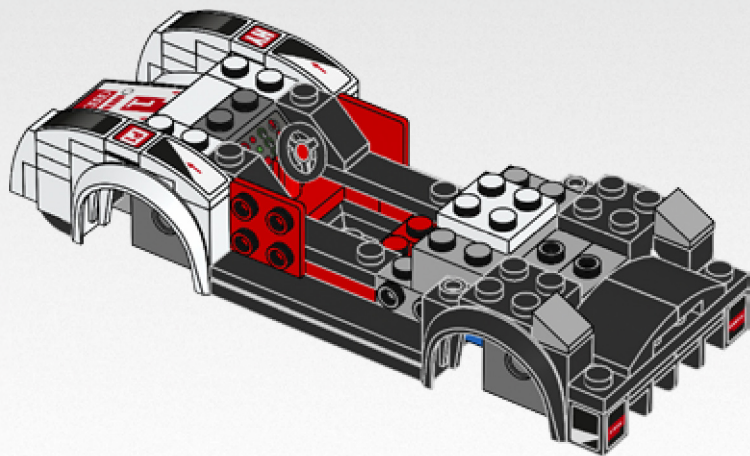



2x

29

1



2



2x

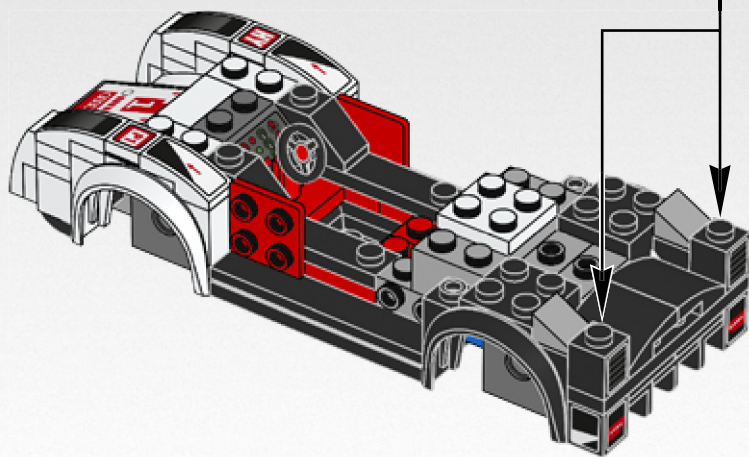

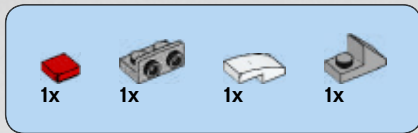

30

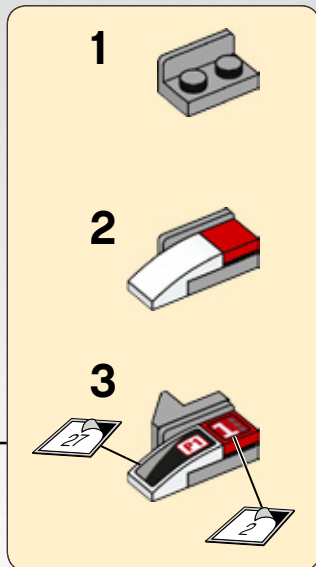
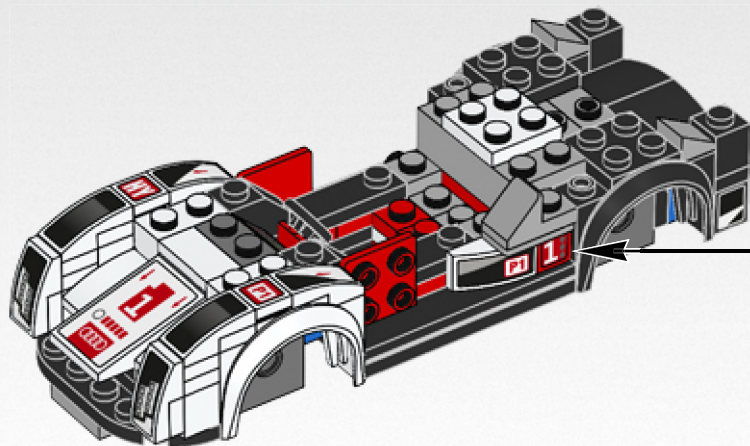

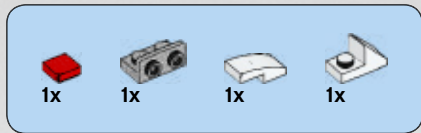

31

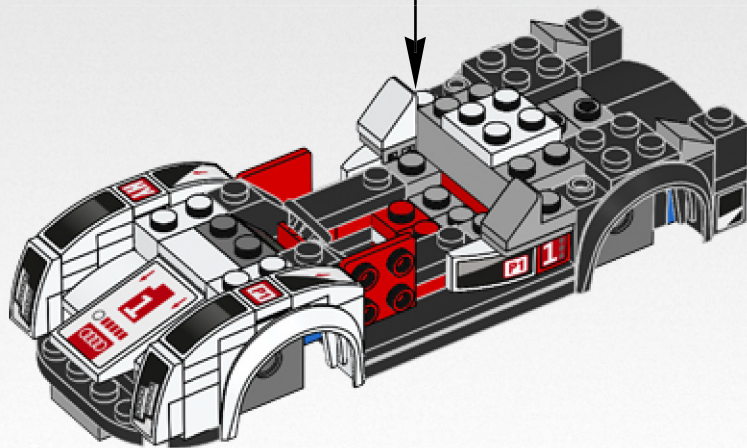
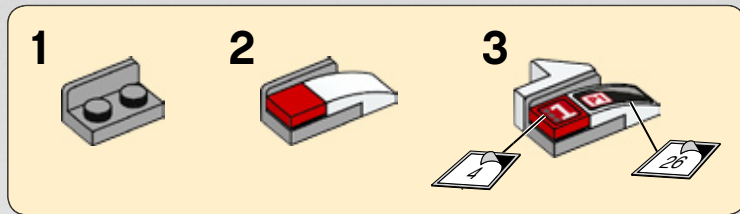



1x



1x



1x

32

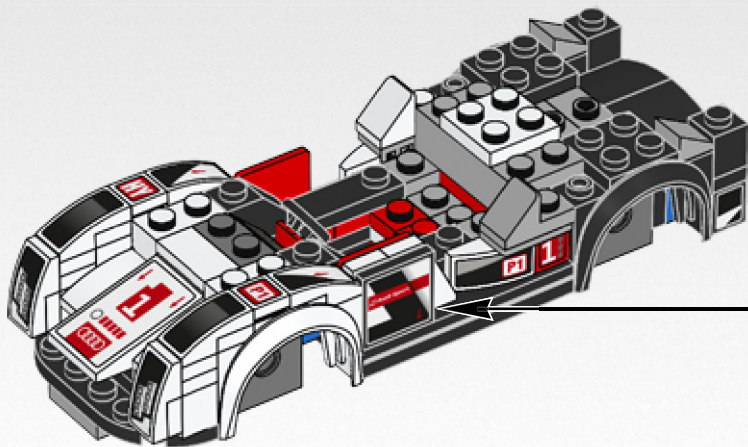

1

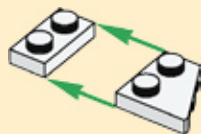

2



3

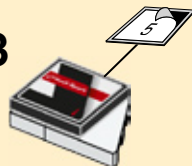

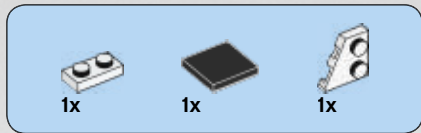

33

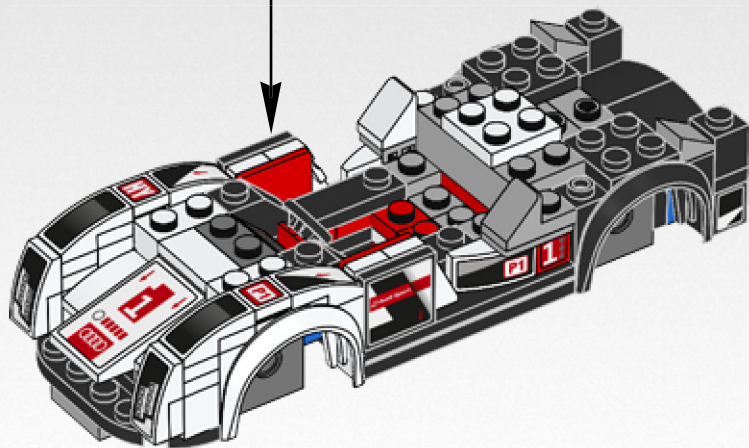
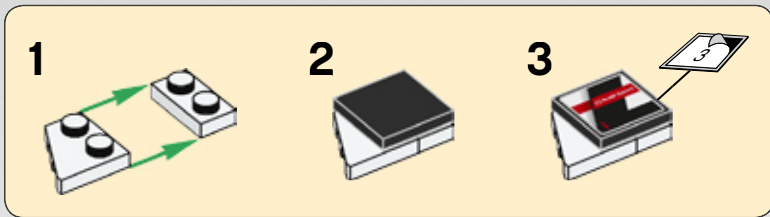



34

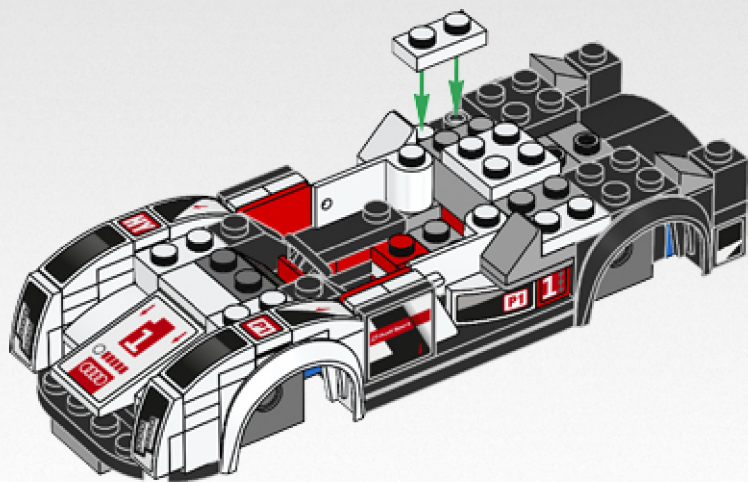



2x



2x

35

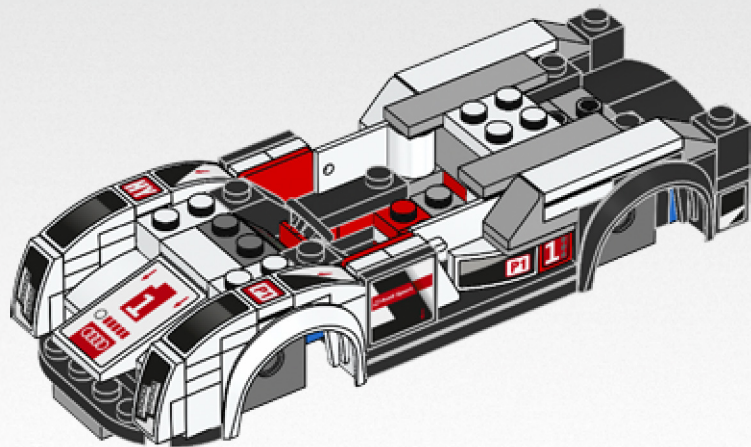

36

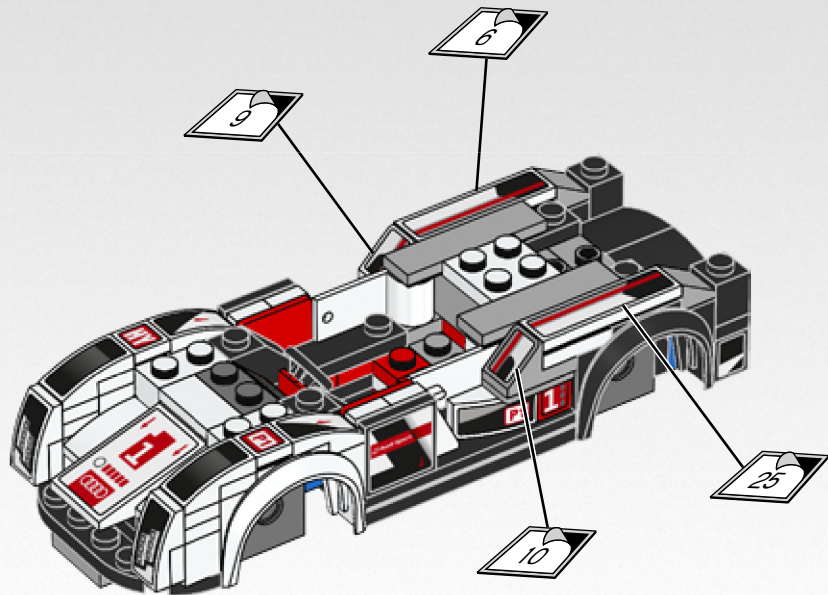

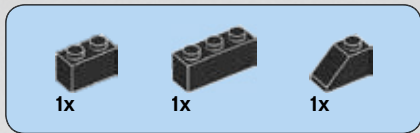

37

1



2

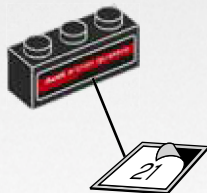

3

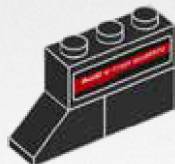

4

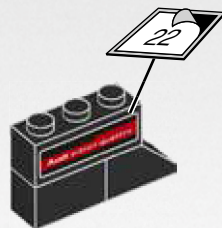

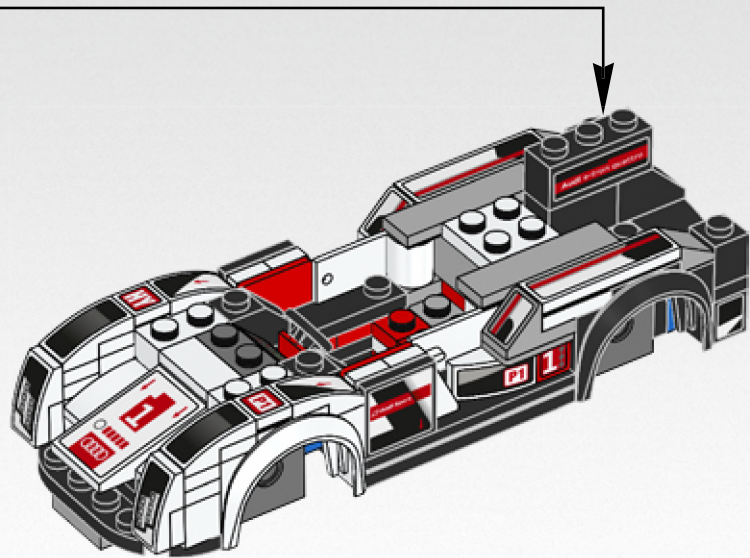



4x

38

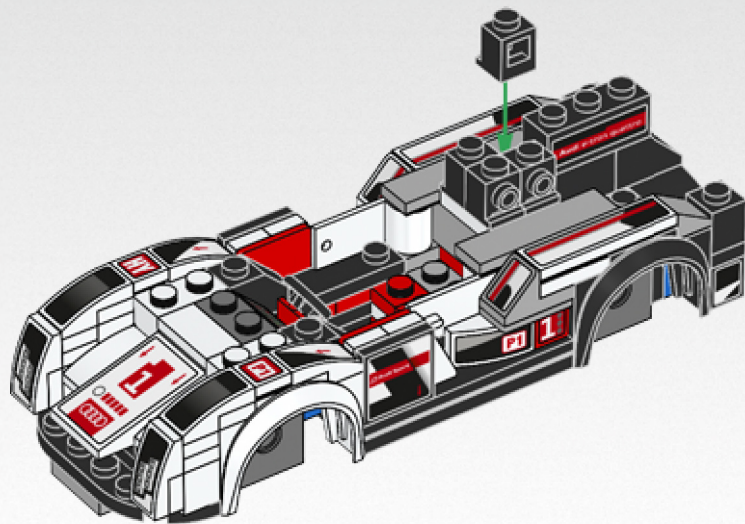



39

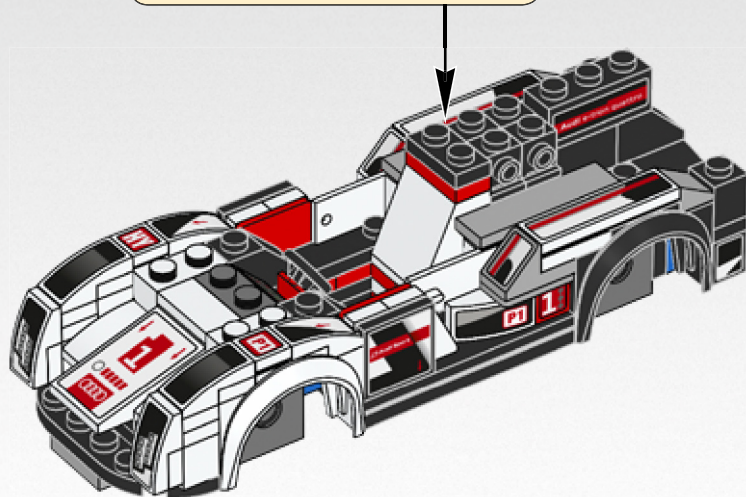
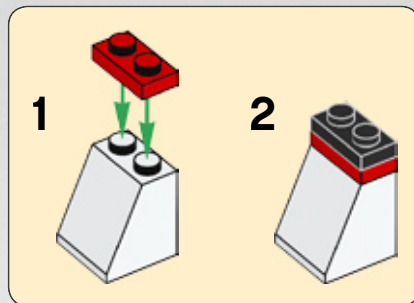



2x

40

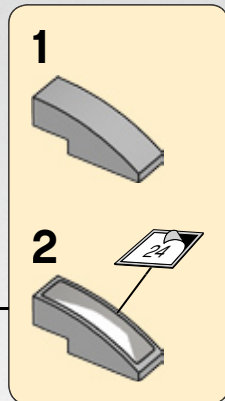
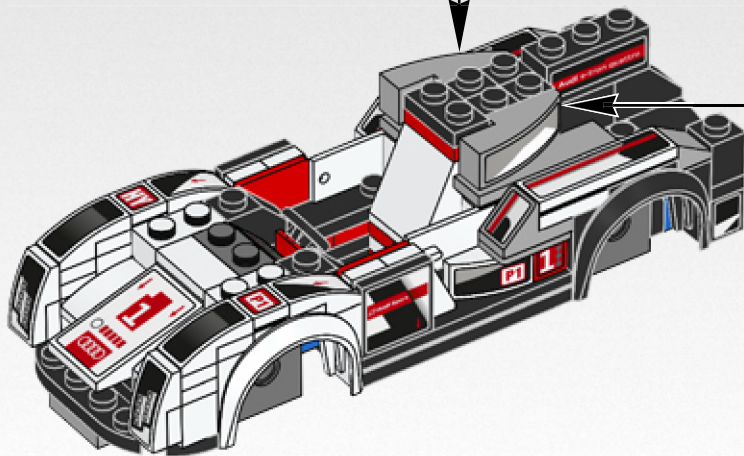
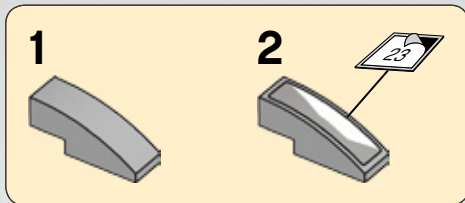



1x



1x



1x

41

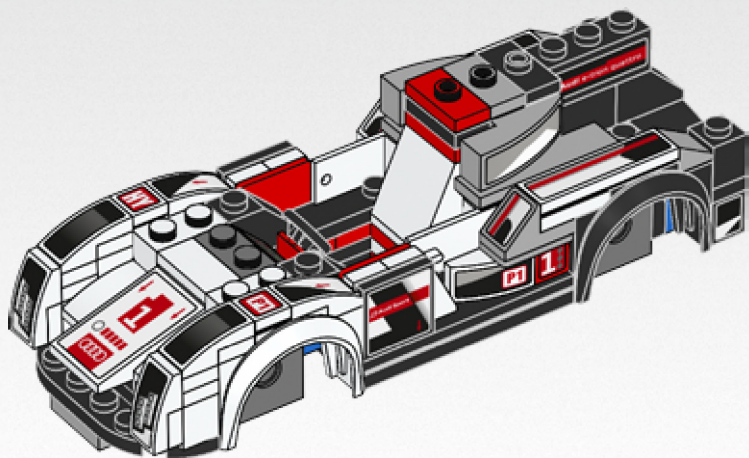



2x

42

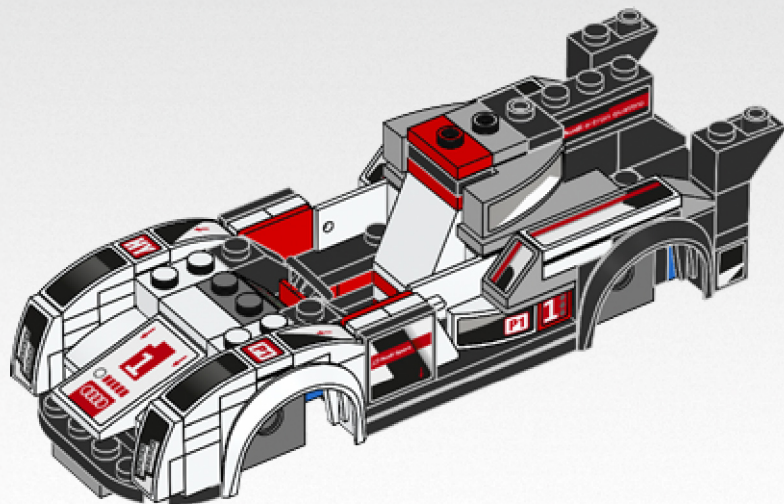

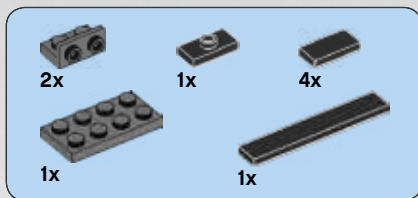

43

1

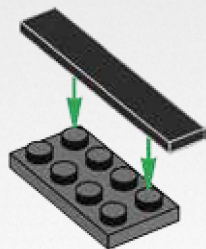

2

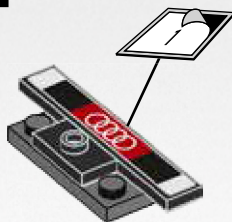

3



4

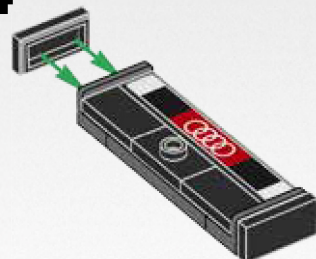

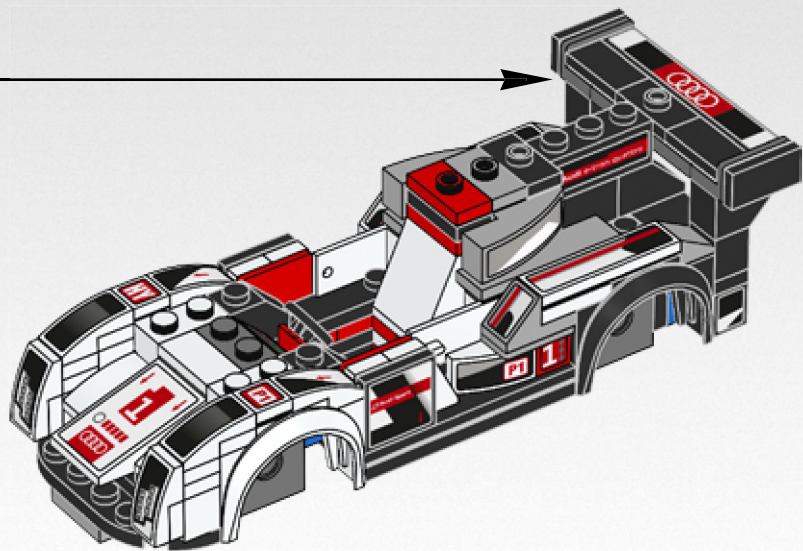

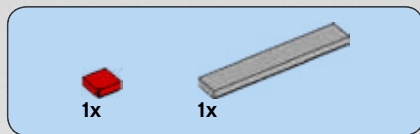

44

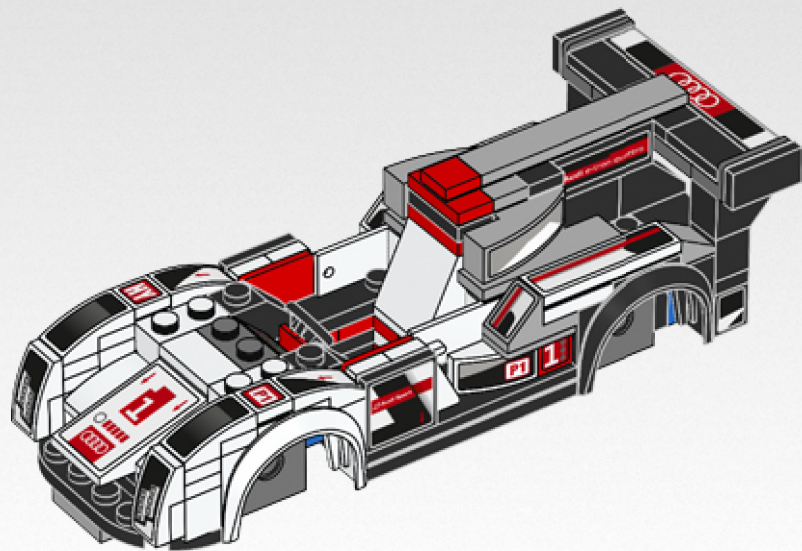

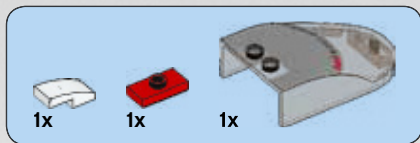

45

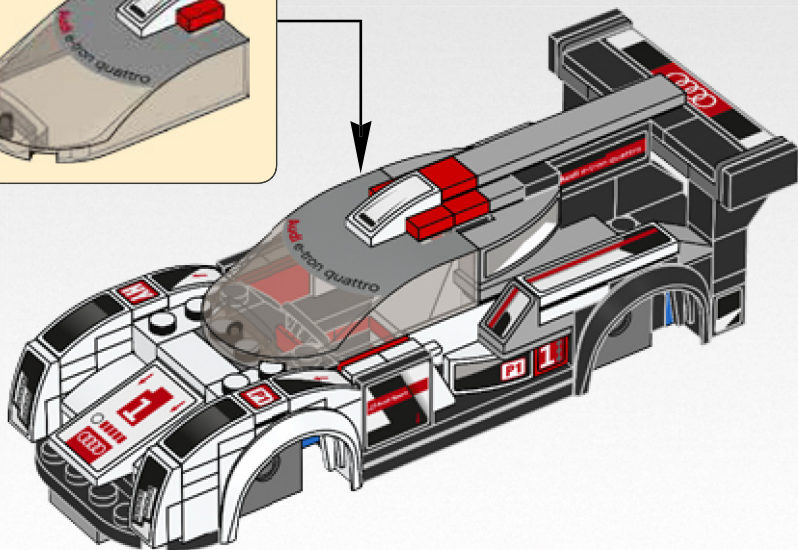
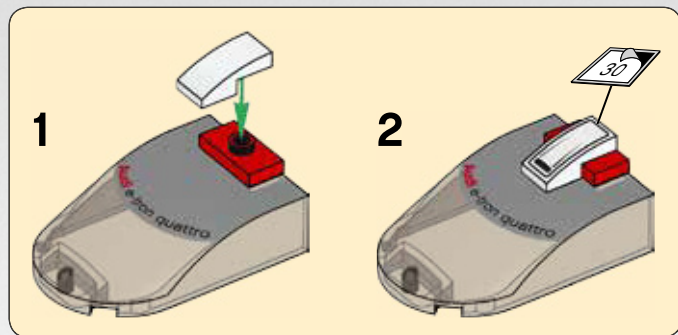

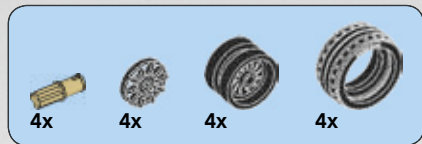

46

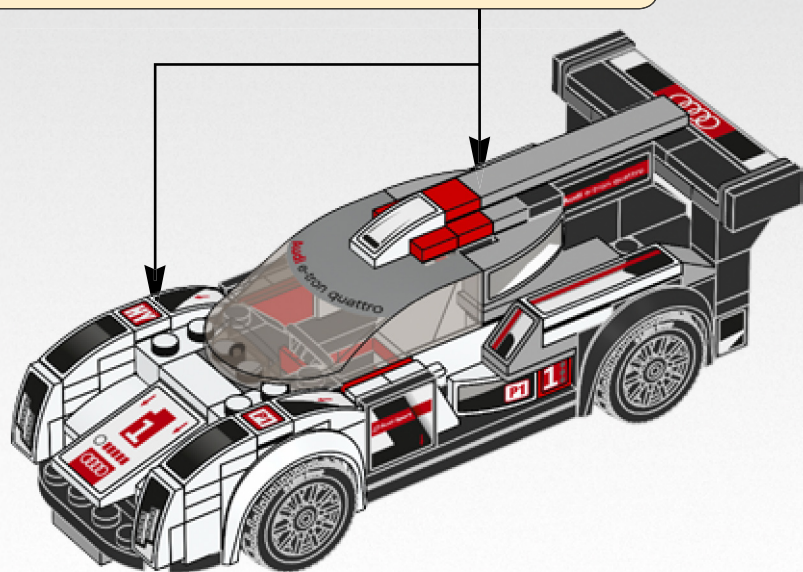

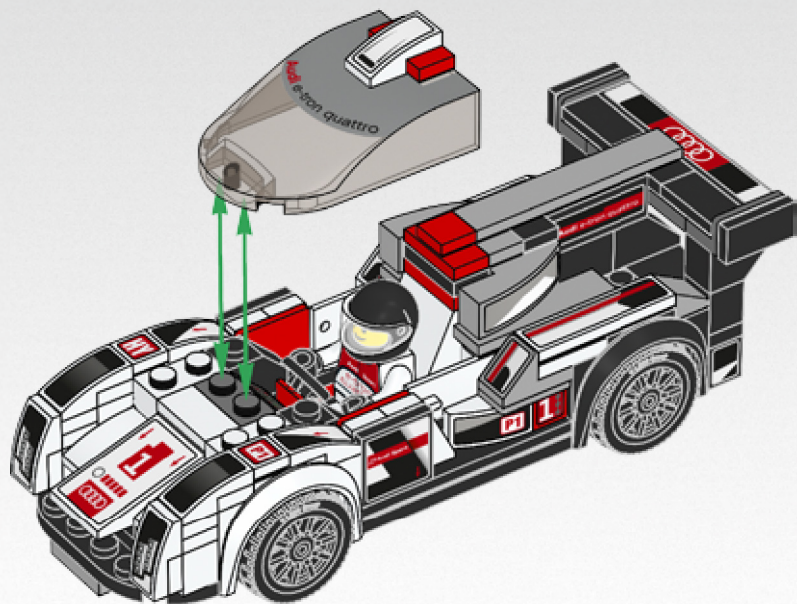

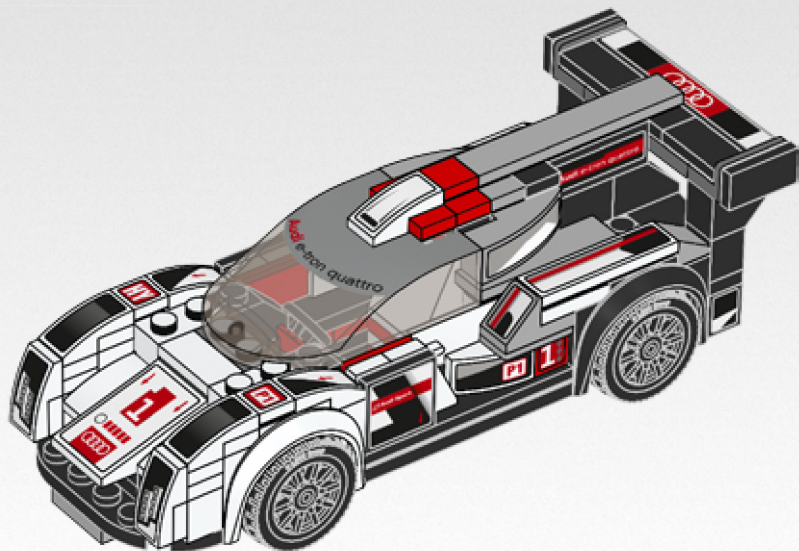
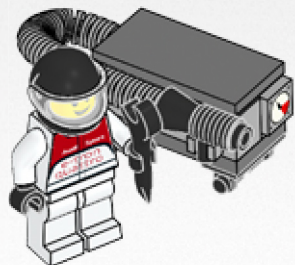
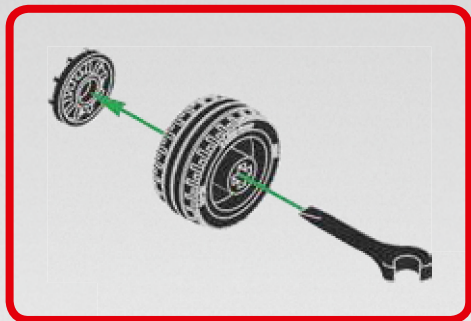



Google Play is a trademark of Google Inc.
Google Play est une marque de commerce de Google Inc.
Google Play es una marca comercial de Google Inc.



Apple, the Apple logo, iPad, iPhone and iPod touch are trademarks of Apple Inc. Apple, le logo Apple, iPad, iPhone et iPod touch sont des marques de commerce d'Apple Inc. Apple, el logotipo de Apple, iPad, iPhone e iPod touch son marcas comerciales de Apple Inc.



WWW.LEGO.COM/SPEEDCHAMPIONS

Officially Licensed by AUDI AG. Oficialmente licencié par AUDI AG. Con licencia oficial de AUDI AG.

Chevrolet, Camaro, Camaro Z/28, Corvette, Corvette Z06, all related emblems, and vehicle body designs are General Motors Trademarks used under license to the LEGO Group. Chevrolet, Camaro, Camaro Z/28, Corvette, Corvette Z06 et tous les emblèmes et designs de carrosserie de véhicule liés sont des marques déposées de General Motors utilisées sous licence au Groupe LEGO. Chevrolet, Camaro, Camaro Z/28, Corvette, Corvette Z06, todos los emblemas relacionados y el diseño de las carrocerías son marcas comerciales de General Motors cuyo uso tiene lugar bajo licencia concedida a The LEGO Group.

Ford Motor Company Trademarks and Trade Dress used under license to the LEGO Group. Les marques déposées et les signes commerciaux de Ford Motor Company sont utilisés sous licence au Groupe LEGO. El uso de las marcas comerciales y la imagen comercial de Ford Motor Company tiene lugar bajo licencia concedida a The LEGO Group.

Under license of Porsche AG. Sous licence de Porsche AG. Con licencia de Porsche AG.



75873
Audi R8 LMS Ultra



75872
Audi R18 e-tron quattro



75870
Chevrolet
Corvette Z06



75874
Chevrolet
Camaro



75874
Chevrolet
Camaro '69



75875
Ford Model A
Hot Rod

75875
Ford F-150 Raptor



75871
Ford Mustang GT



75876
Porsche 919 Hybrid



75876
Porsche 917 K



Audi



CHEVROLET



PORSCHE

Officially Licensed by AUDI AG. Oficialmente licencié par AUDI AG. Con licencia oficial de AUDI AG.

Chevrolet, Camaro, Camaro Z/28, Corvette, Corvette Z06, all related emblems, and vehicle body designs are General Motors Trademarks used under license to the LEGO Group. Chevrolet, Camaro, Camaro Z/28, Corvette, Corvette Z06, all related emblems and designs of car body designs are General Motors Trademarks used under license to the LEGO Group. Chevrolet, Camaro, Camaro Z/28, Corvette, Corvette Z06, todos los emblemas relacionados y el diseño de las carrocerías son marcas comerciales de General Motors cuyo uso tiene lugar bajo licencia concedida a The LEGO Group.

Ford Motor Company Trademarks and Trade Dress used under license to the LEGO Group. Les marques déposées et les signes commerciaux de Ford Motor Company sont utilisés sous licence au Groupe LEGO. El uso de las marcas comerciales y la imagen comercial de Ford Motor Company tiene lugar bajo licencia concedida a The LEGO Group.

Under license of Porsche AG. Sous licence de Porsche AG. Con licencia de Porsche AG.



Officially Licensed by AUDI AG. Oficialmente licencié par AUDI AG. Con licencia oficial de AUDI AG. Chevrolet, Camaro, Camaro Z/28, Corvette, Corvette Z06, all related emblems, and vehicle body designs are General Motors Trademarks used under license to the LEGO Group. Chevrolet, Camaro, Camaro Z/28, Corvette, Corvette Z06 et tous les emblemes et designs de carrosserie de véhicule liés sont des marques déposées de General Motors utilisées sous licence au Groupe LEGO. Chevrolet, Camaro, Camaro Z/28, Corvette, Corvette Z06, todos los emblemas relacionados y el diseño de las carrocerías son marcas comerciales de General Motors cuyo uso tiene lugar bajo licencia concedida a The LEGO Group. Les marques déposées et les signes commerciaux de Ford Motor Company sont utilisés sous licence au Groupe LEGO. El uso de las marcas comerciales y la imagen Under license of Porsche AG. Sous licence de Porsche AG. Con licencia de Porsche AG.

1x 6142019	1x 9327	2x 6000606	4x 4666579	2x 366526	1x 400626	1x 6107390	1x 4211428	1x 4255629	3x 307021
11x 6034044	1x 4537987	1x 4211054	4x 407026	1x 300426	4x 6102596	1x 4656764	2x 4251163	2x 4521921	3x 302321
2x 4558952	4x 302201	2x 6150297	2x 4504382	2x 393826	2x 4599499	1x 4656764	1x 6028811	2x 4211476	2x 6001806
8x 302401	4x 302201	2x 6150297	2x 4106347	3x 302326	3x 302326	3x 371023	1x 6028811	1x 4533772	2x 242021
2x 307001	1x 4234525	2x 4211043	4x 300526	1x 434926	2x 6112243	3x 371023	1x 4211385	1x 6093859	1x 302221
1x 6132203	1x 4527637	1x 4560184	1x 4298619	2x 6000650	1x 6105963	1x 6138954	2x 6004990	3x 6066097	2x 6092565
1x 6132204	2x 243101	2x 4211065	1x 6115086	4x 6104403	1x 366626	1x 6056596	3x 4654577	1x 6092565	1x 9552
1x 6069002	2x 6102583	1x 4626724	4x 306926	2x 306826	3x 663626	1x 4211549	1x 4211356	2x 4211356	
4x 302301	2x 6102583	1x 4570043	3x 4121966	2x 6053077	2x 6092585				
1x 306901	1x 4143000	1x 302024	1x 362226						



Customer Service

Kundenservice

Service Consommateurs

Servicio Al Consumidor

LEGO.com/service or dial



: 00800 5346 5555

: 1-800-422-5346

WIN

GO TO WWW.LEGO.COM/PRODUCTFEEDBACK AND
GIVE US YOUR SHORT **FEEDBACK** ABOUT THIS
LEGO® SET FOR A CHANCE TO WIN
A COOL LEGO PRIZE.



LEGO.com/productfeedback

GEWINNE



Erzähle uns auf
www.LEGO.com/productfeedback

etwas über die Erfahrungen, die du mit
diesem LEGO® Set gemacht hast, und
sichere dir die Chance auf einen coolen
LEGO Preis!

GAGNE



Rends-toi sur
www.LEGO.com/productfeedback

et donne-nous quelques commentaires
sur ce produit LEGO® pour avoir une
chance de gagner un prix LEGO !

GANAN



Visita
www.LEGO.com/productfeedback

y envíanos tu opinión acerca de este set
LEGO®. ¡Participarás en el sorteo de un
premio LEGO!

获取奖品



登录
www.LEGO.com/productfeedback

给出关于此乐高®套装的简短反馈，
就有机会获得炫酷乐高大奖品

LEGO and the LEGO logo are trademarks and/or copyrights of the/son des marques de commerce et/ou copyrights du/son marcas registradas, algunas de ellas protegidas por derechos de autor, de LEGO Group. ©2016 The LEGO Group. All rights reserved/Tous droits réservés/Todos los derechos reservados.

Officially Licensed by AUDI AG./Officiellement licencié par AUDI AG./Con licencia oficial de AUDI AG.

6159500 / 6159501