

10251

CREATOR

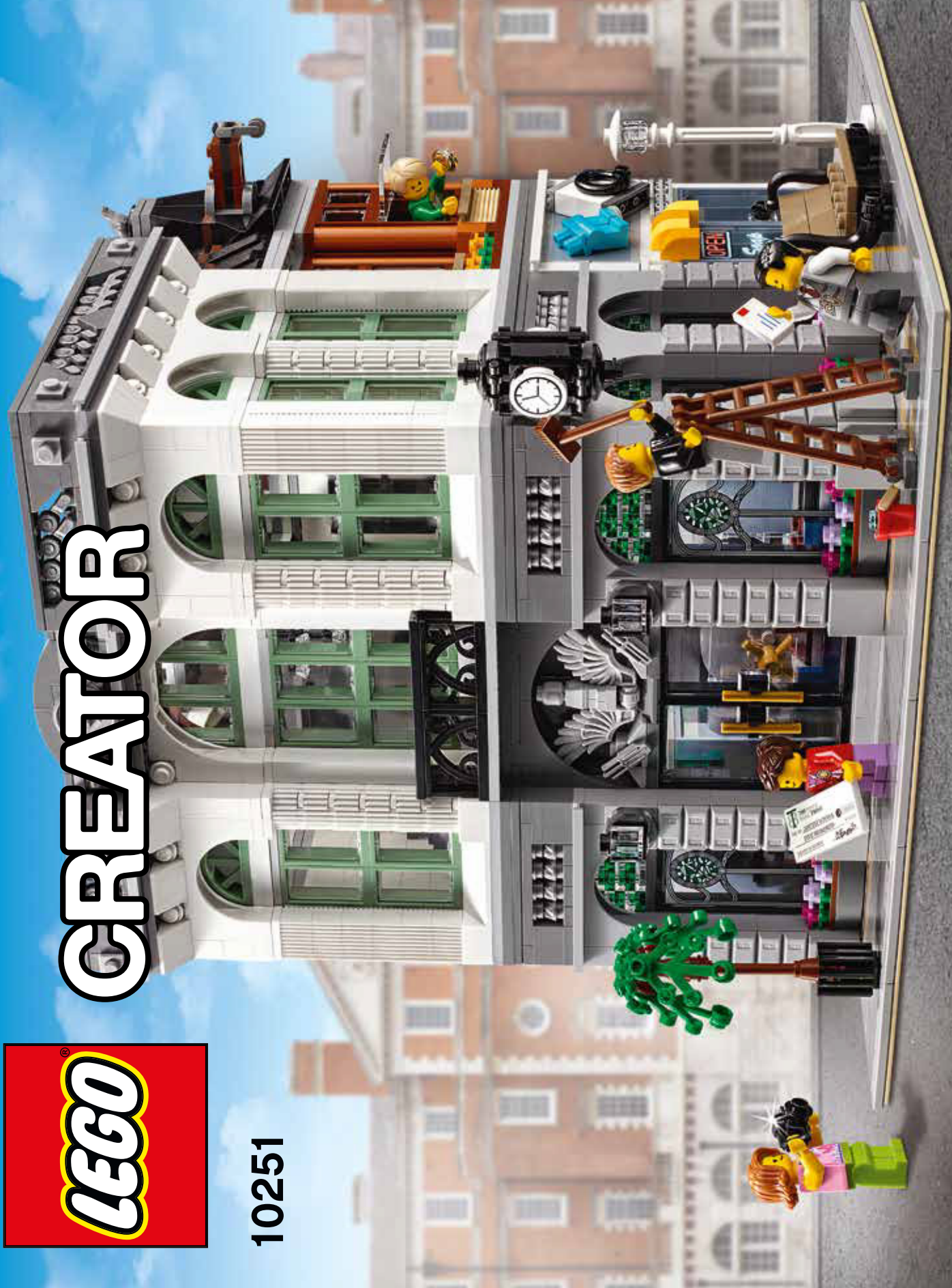

LEGO.com/creator

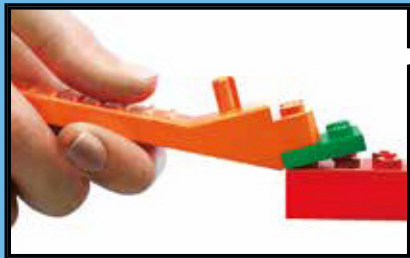
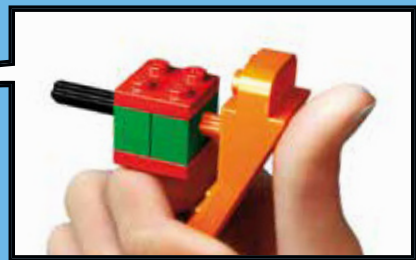
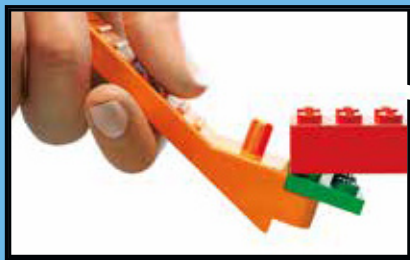

LEGO.com/brickseparator

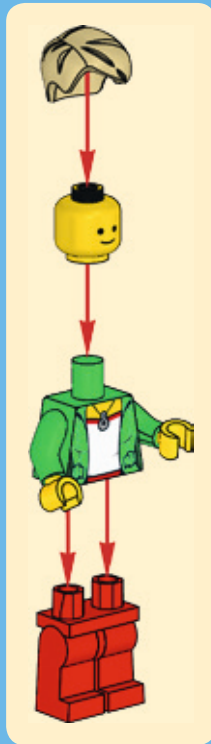



1x



10x

1

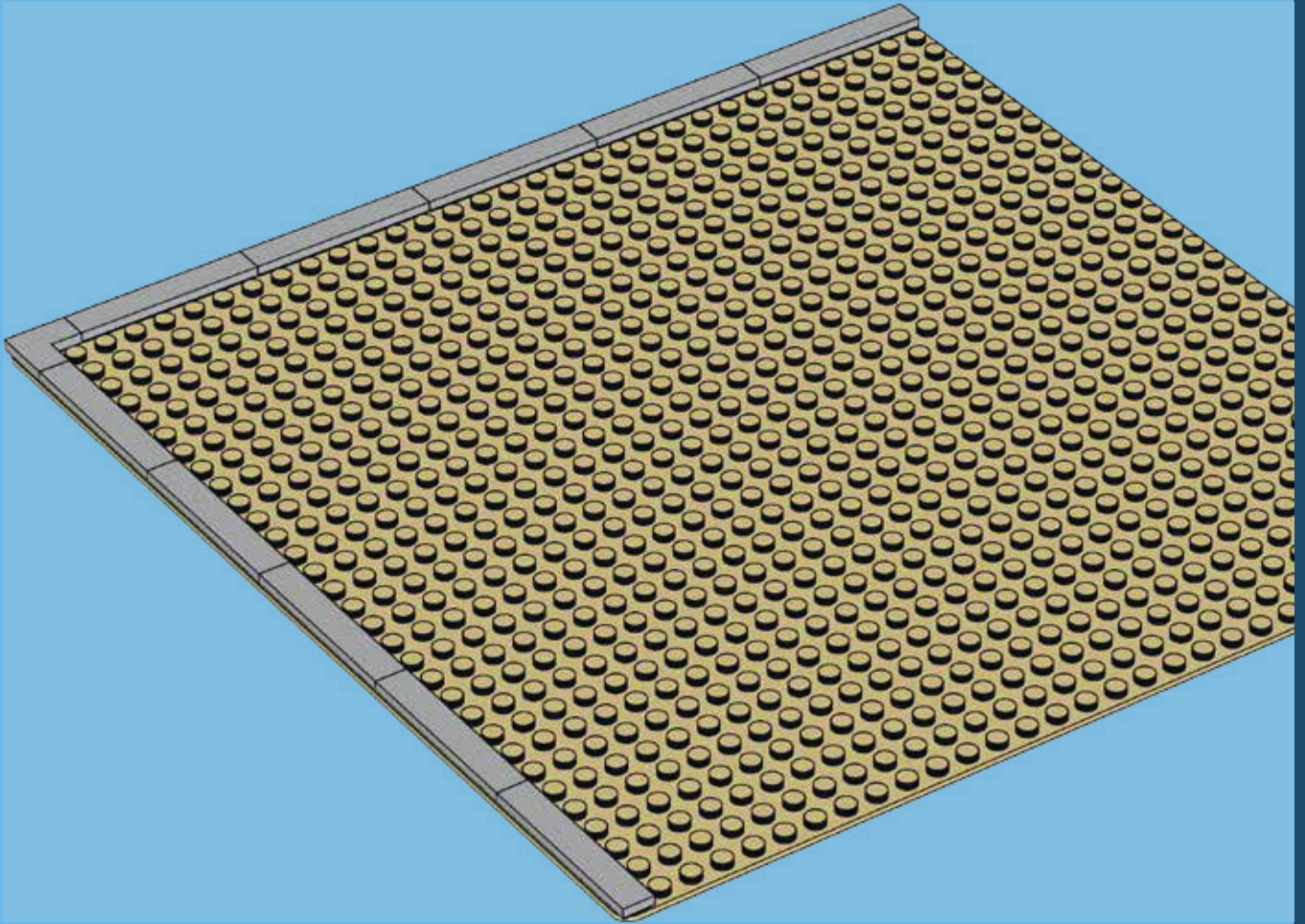

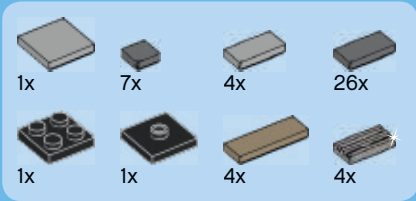

2

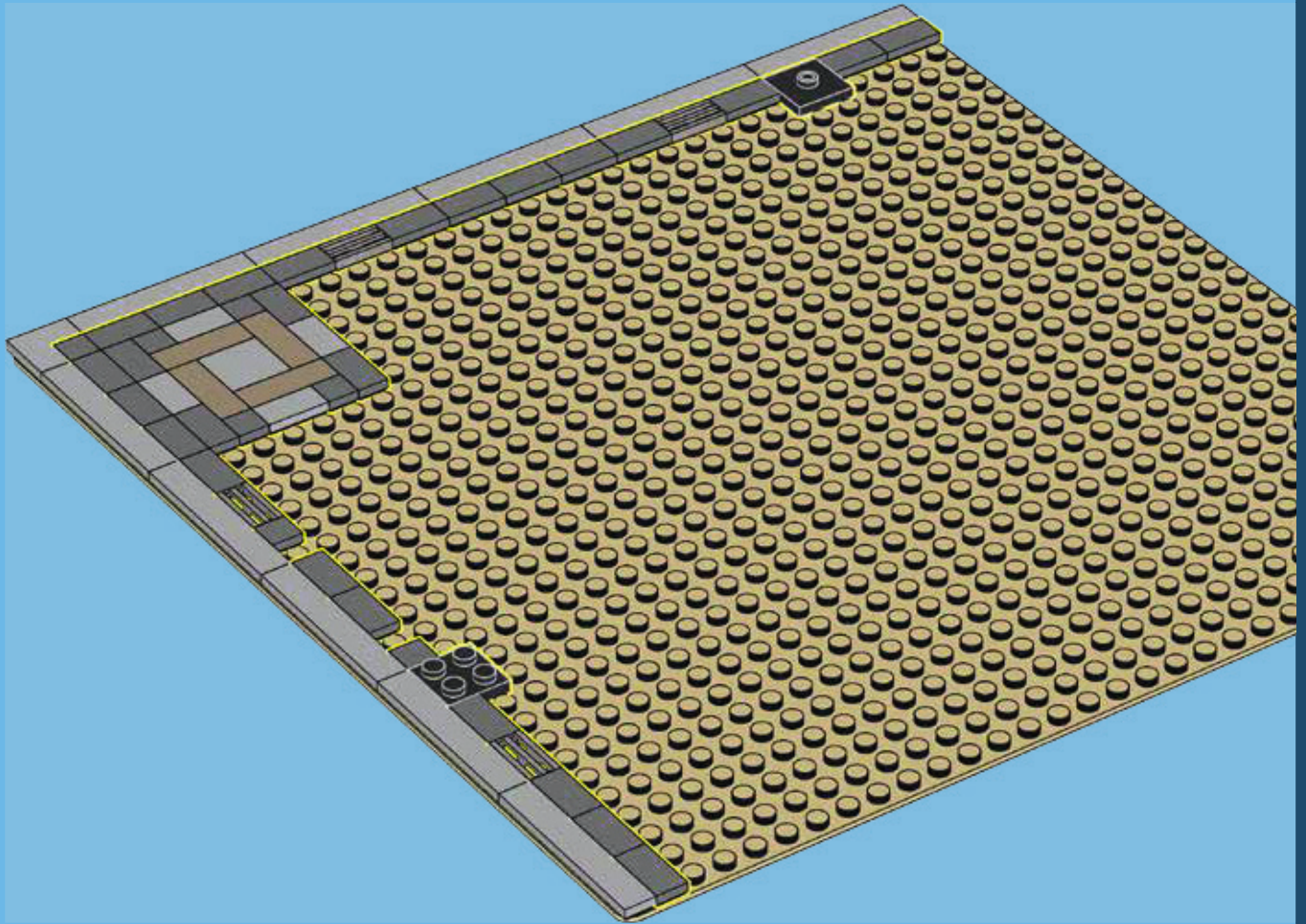

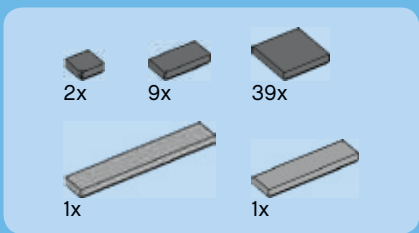

3

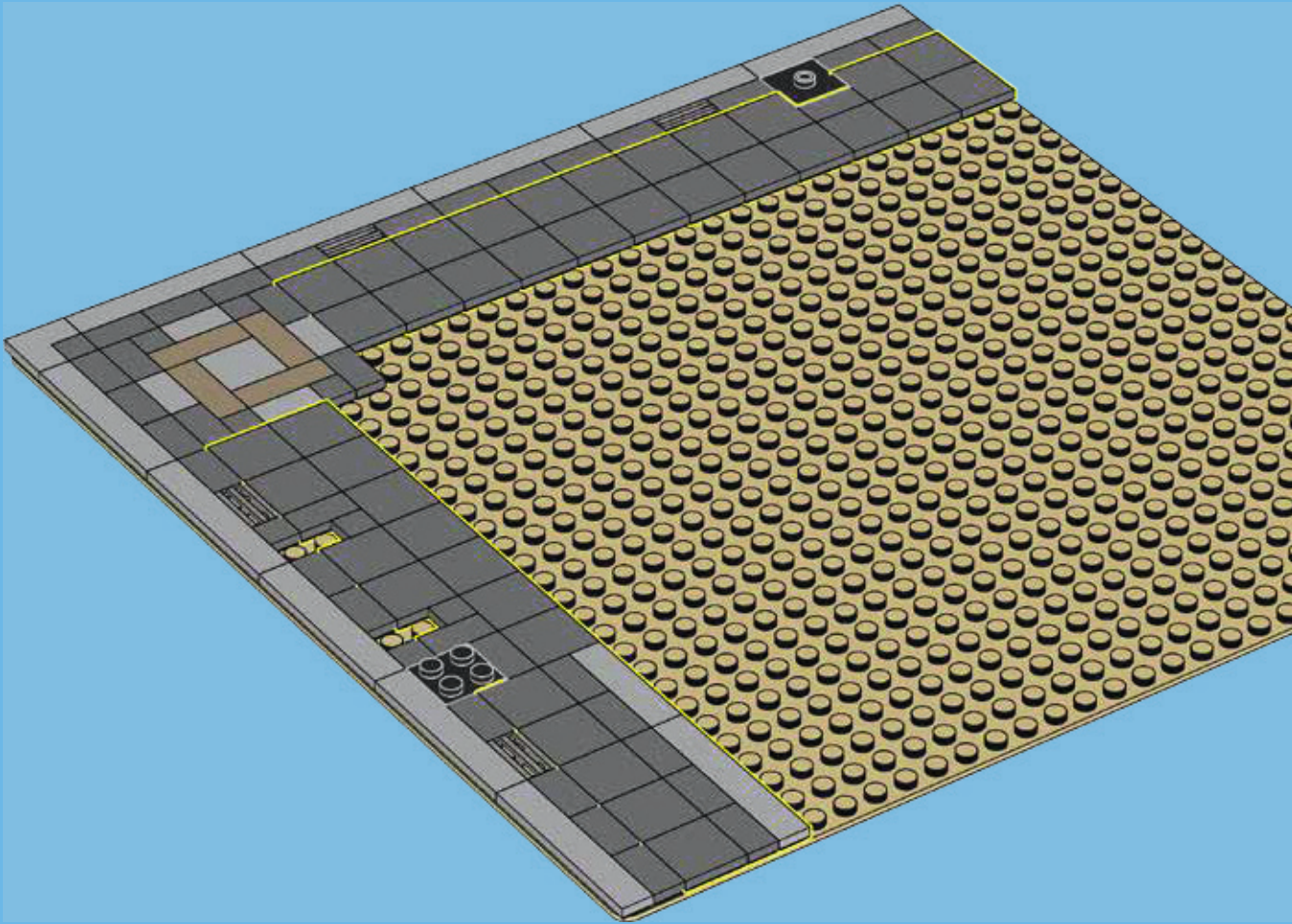

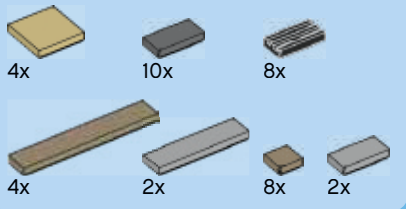

4

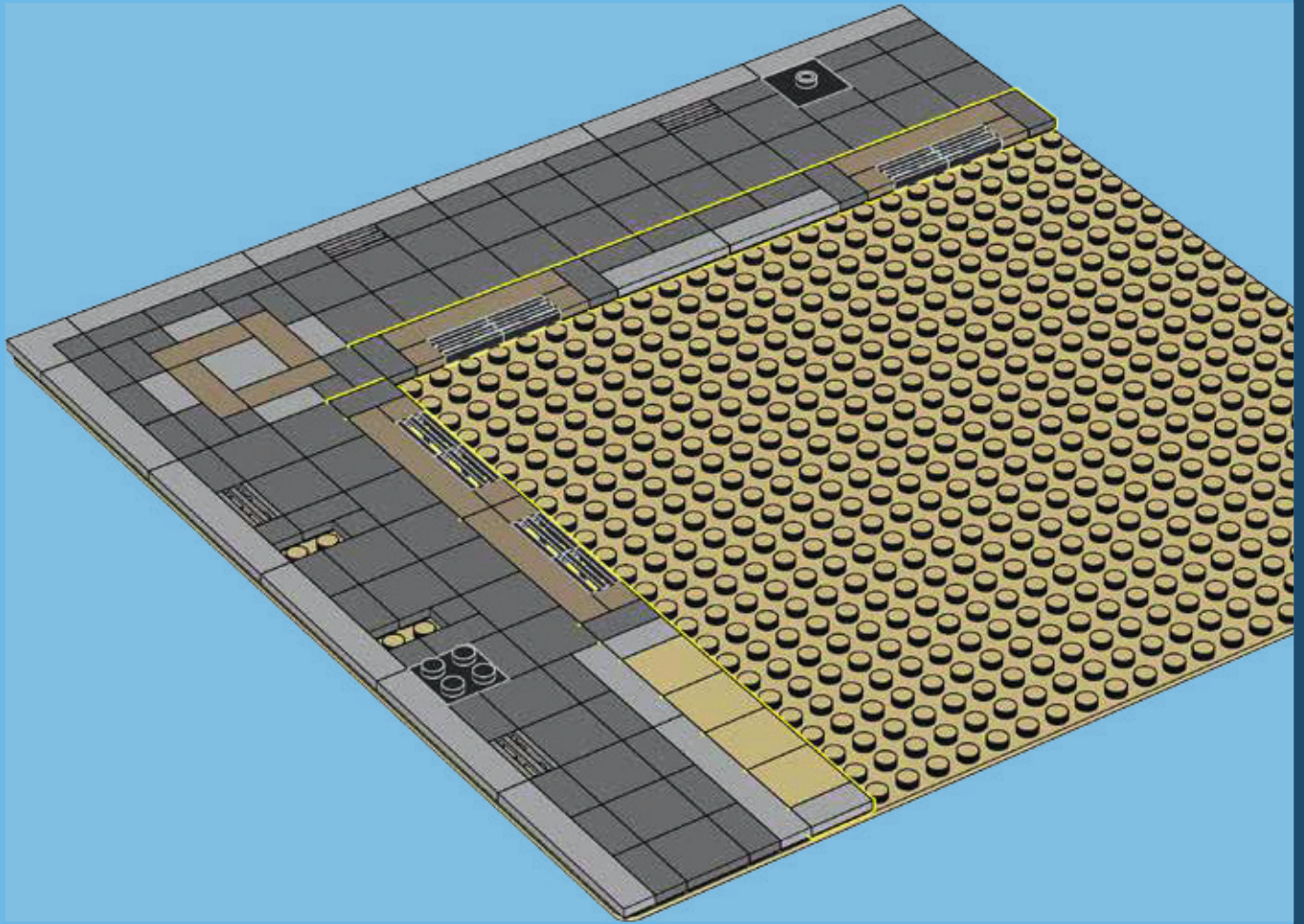



4x

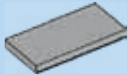

2x



7x



4x



1x



3x

5

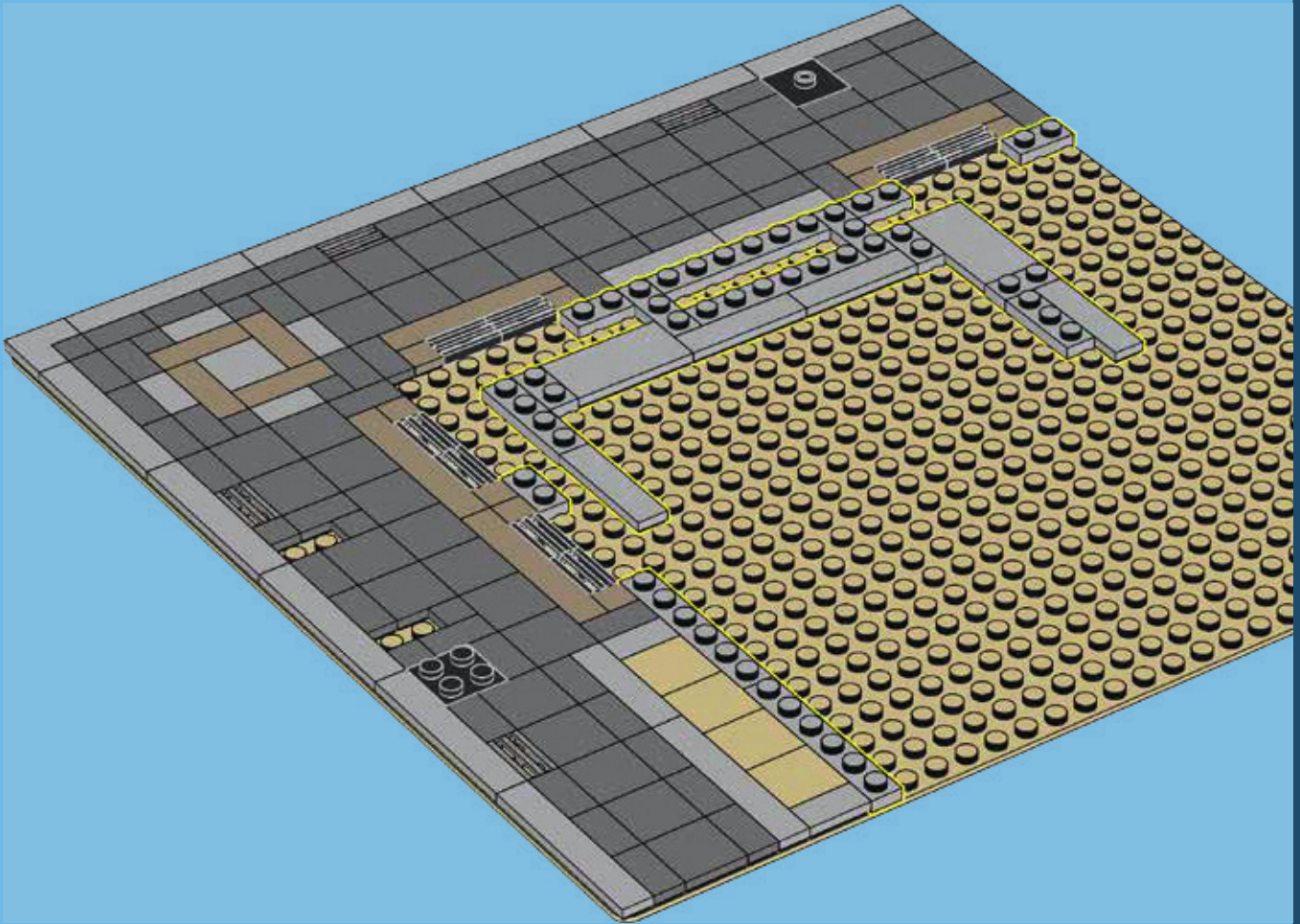



8x



4x



4x



4x



4x



8x

6

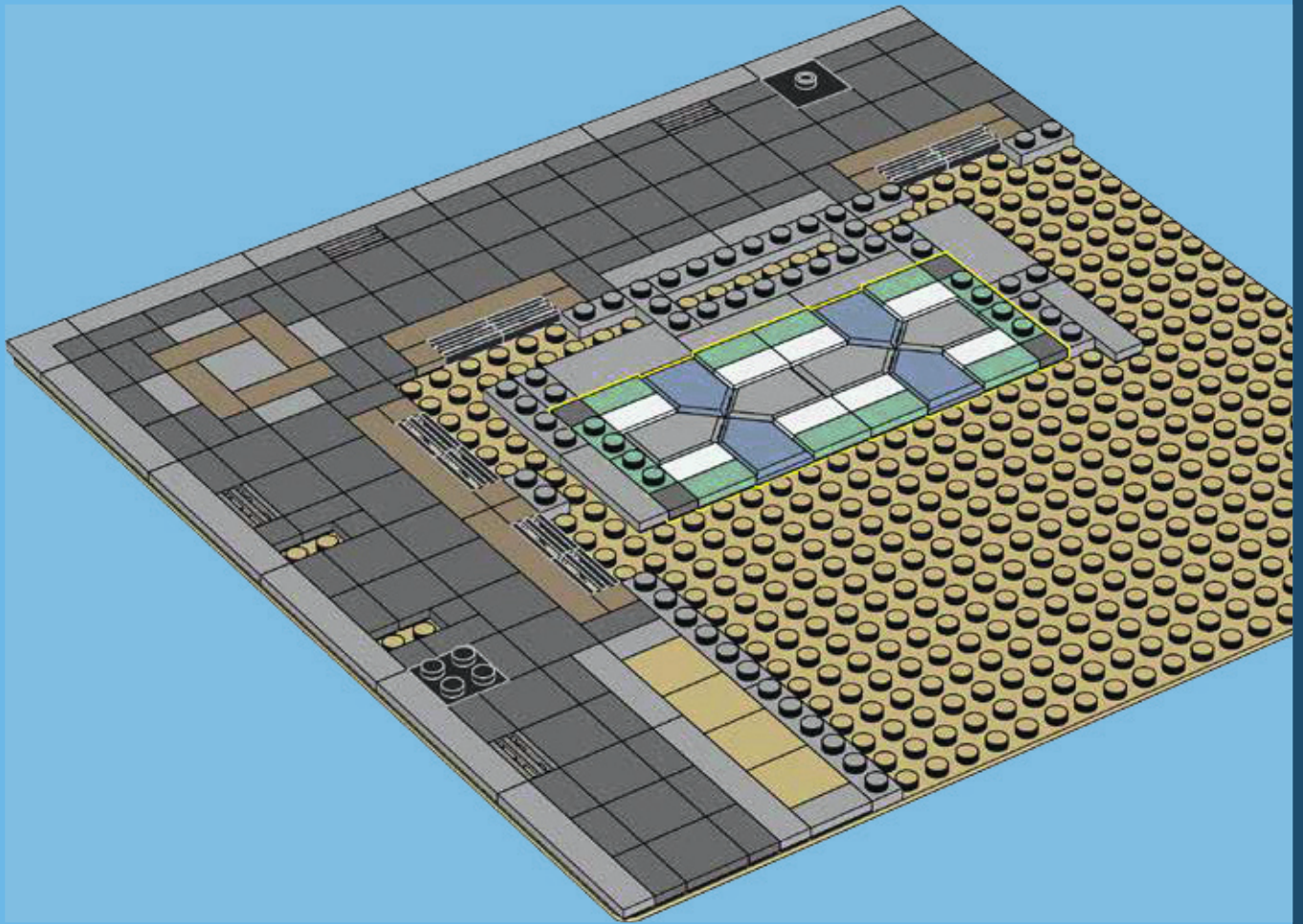

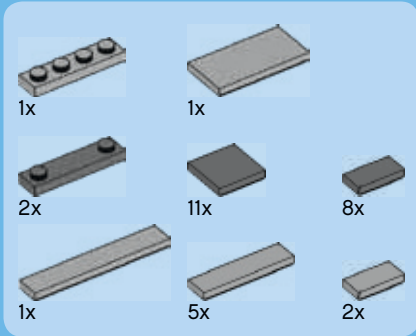



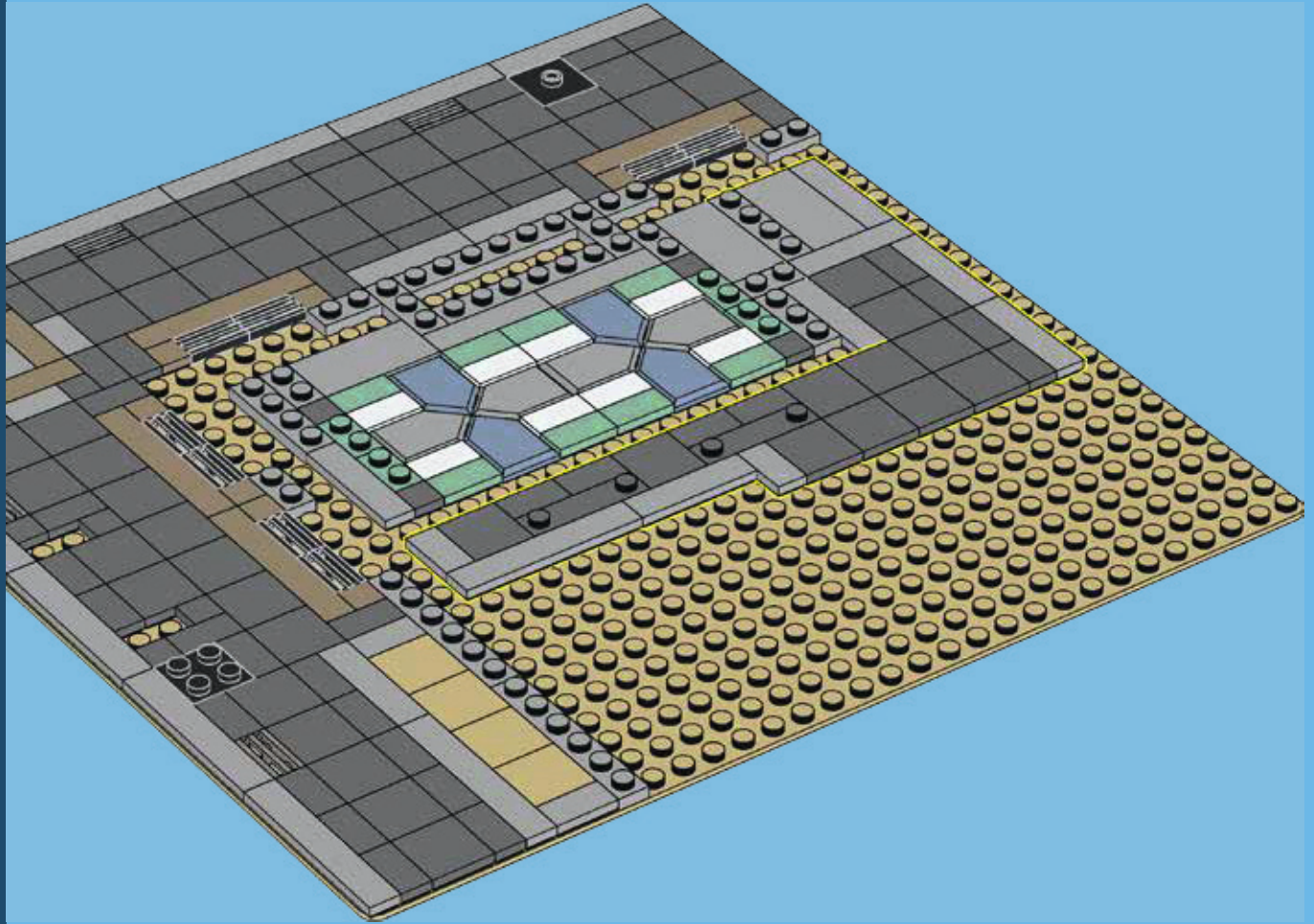

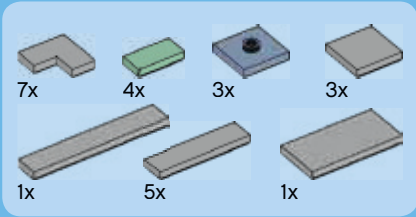

7

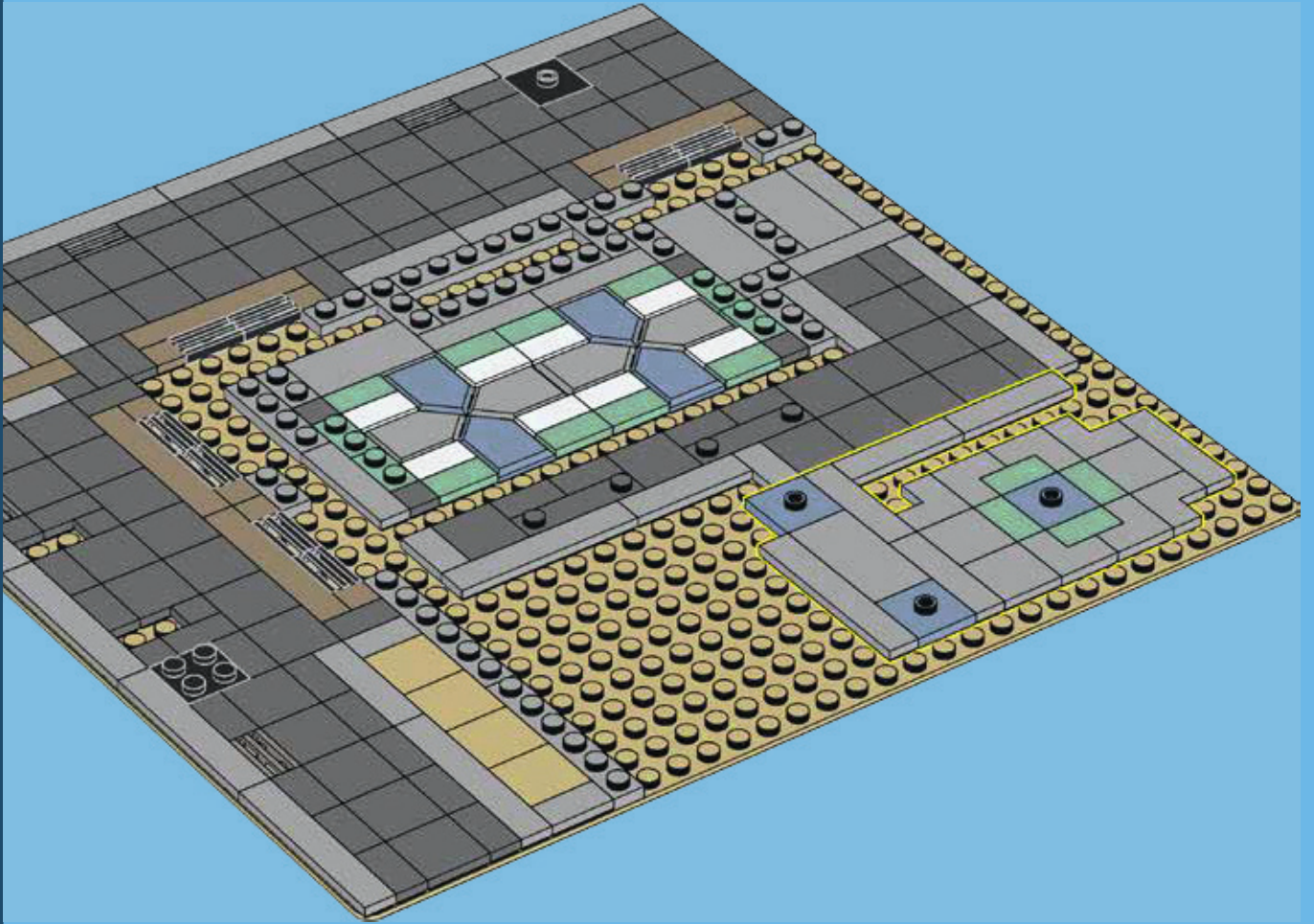



8



 6x	 7x	 7x
 1x	 10x	 2x

9

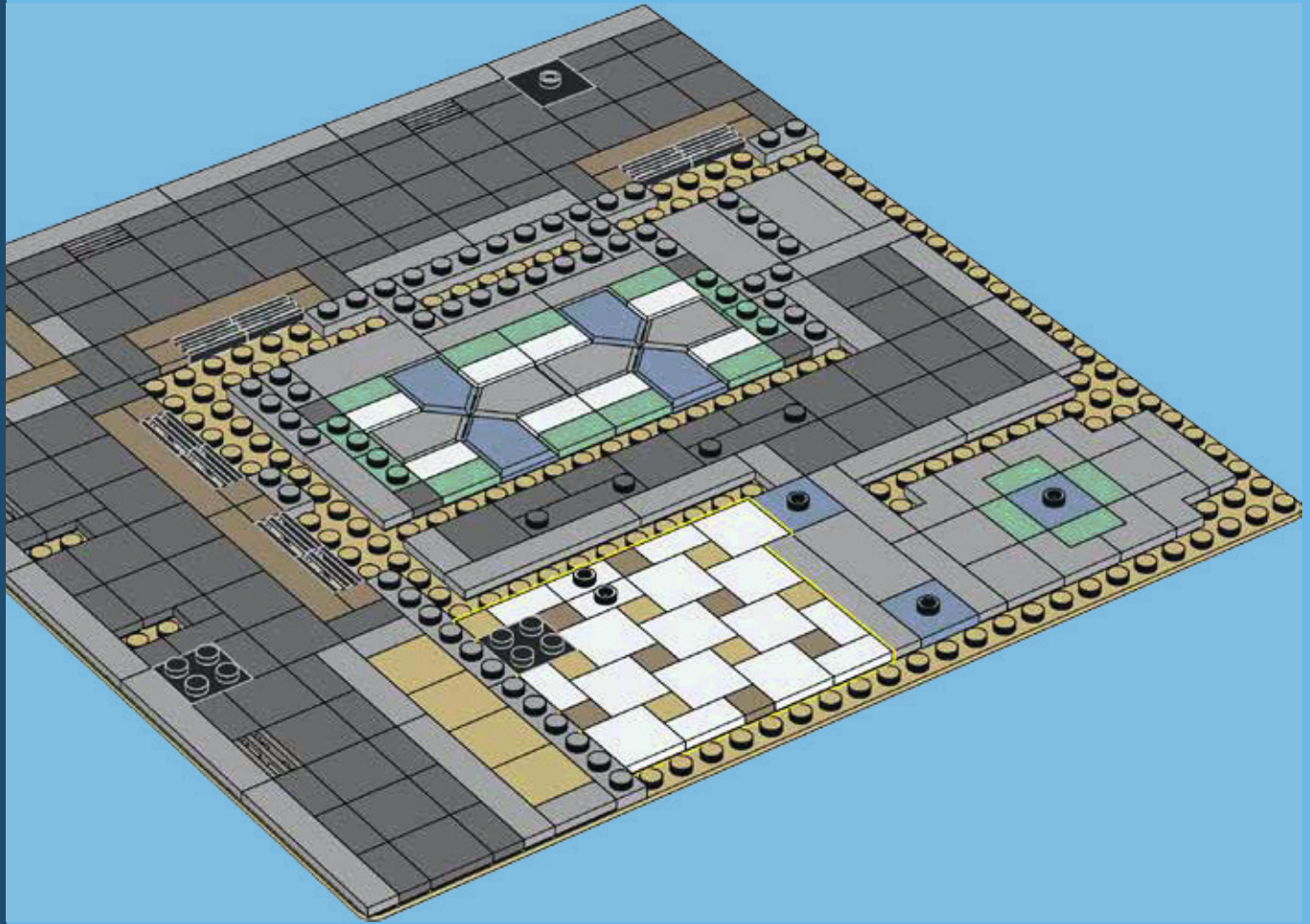

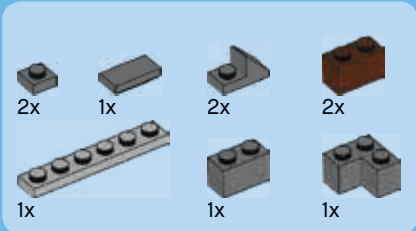

10

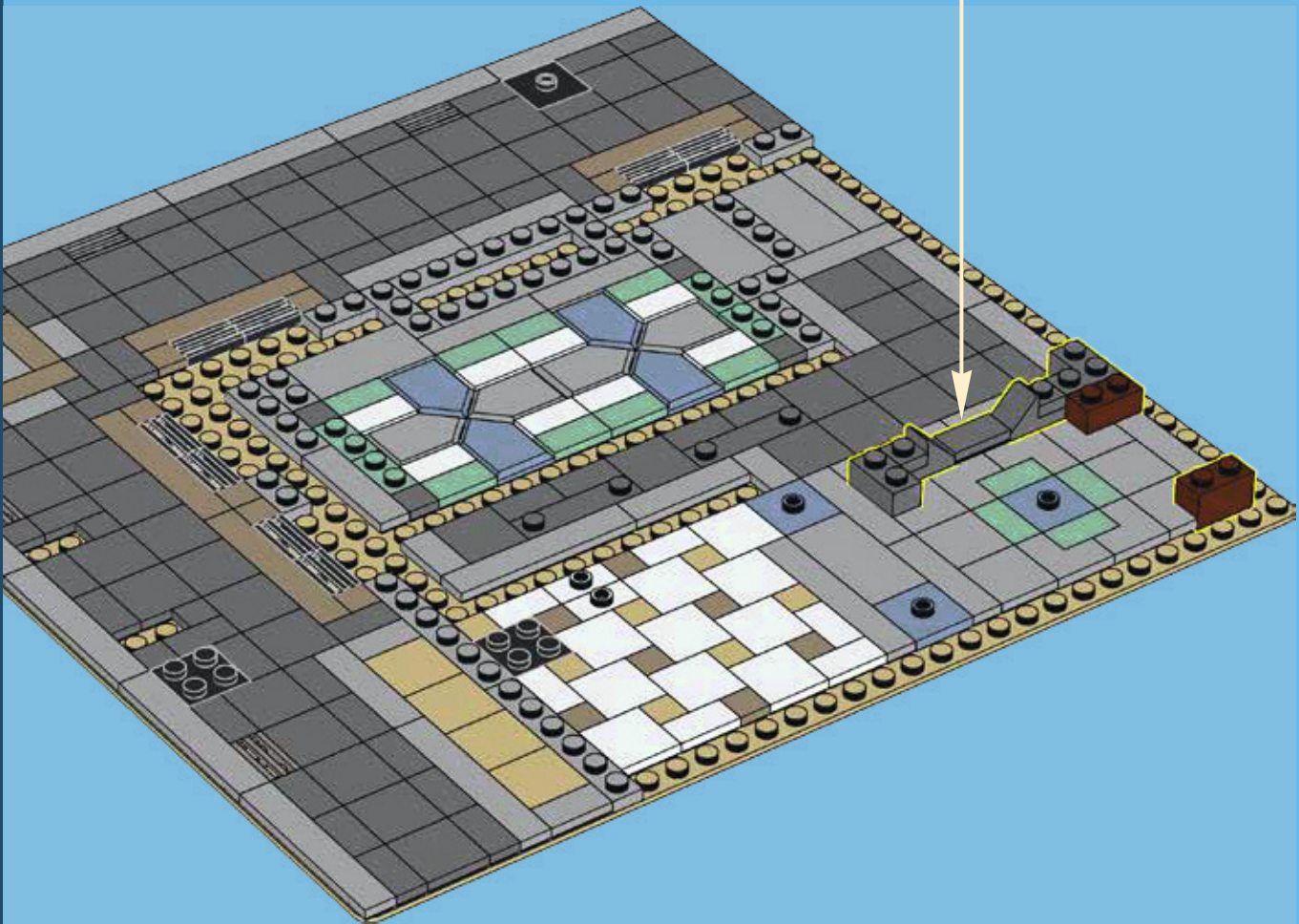
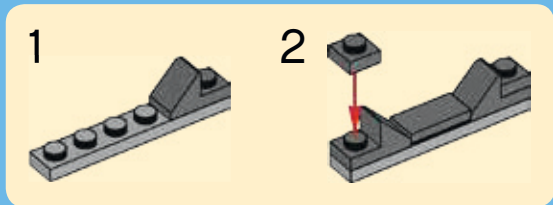

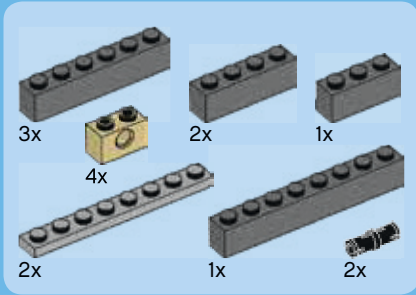

11

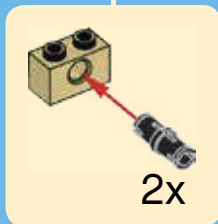
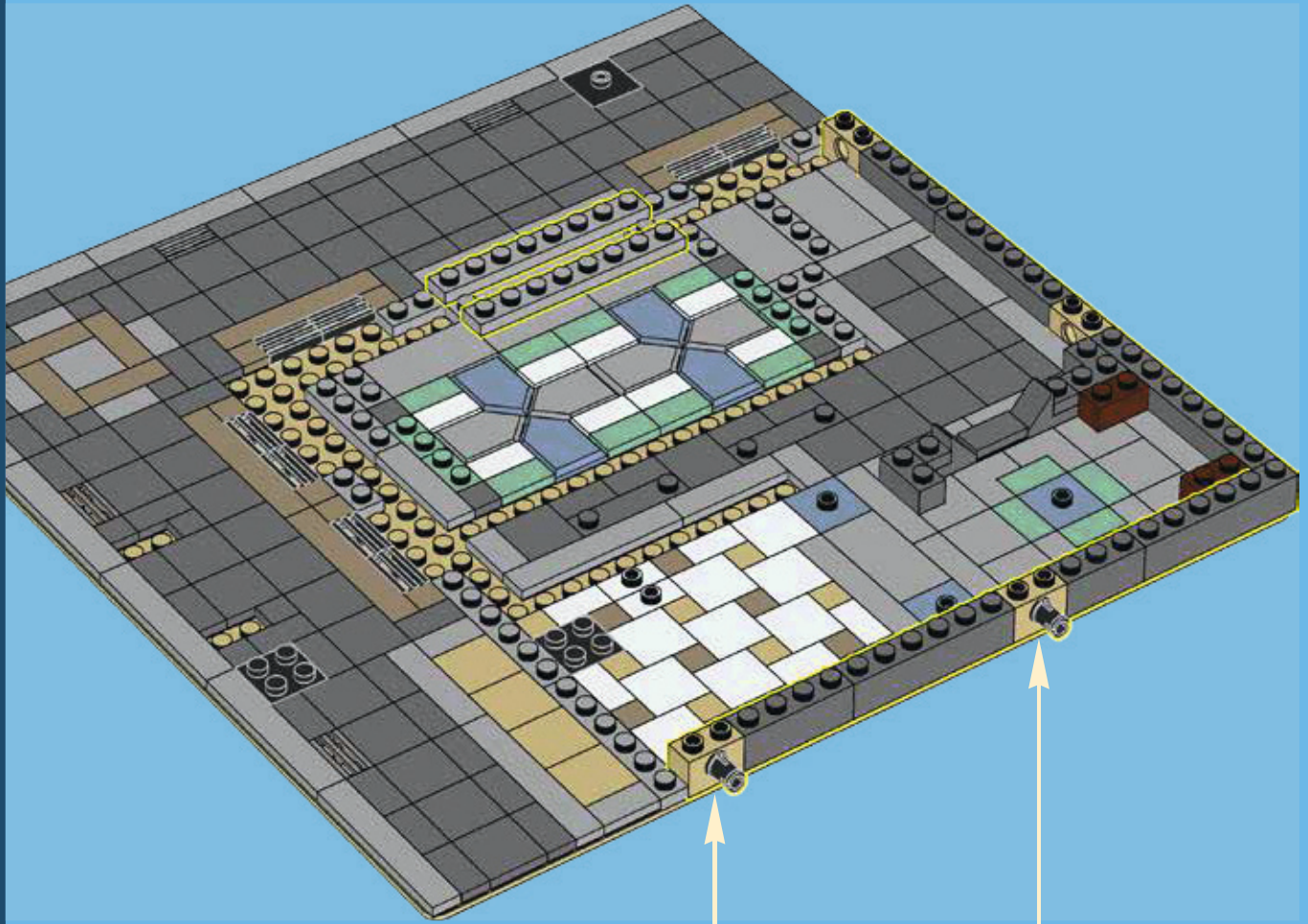

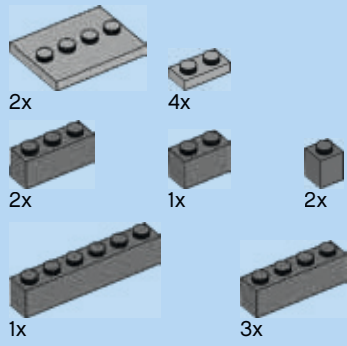

12

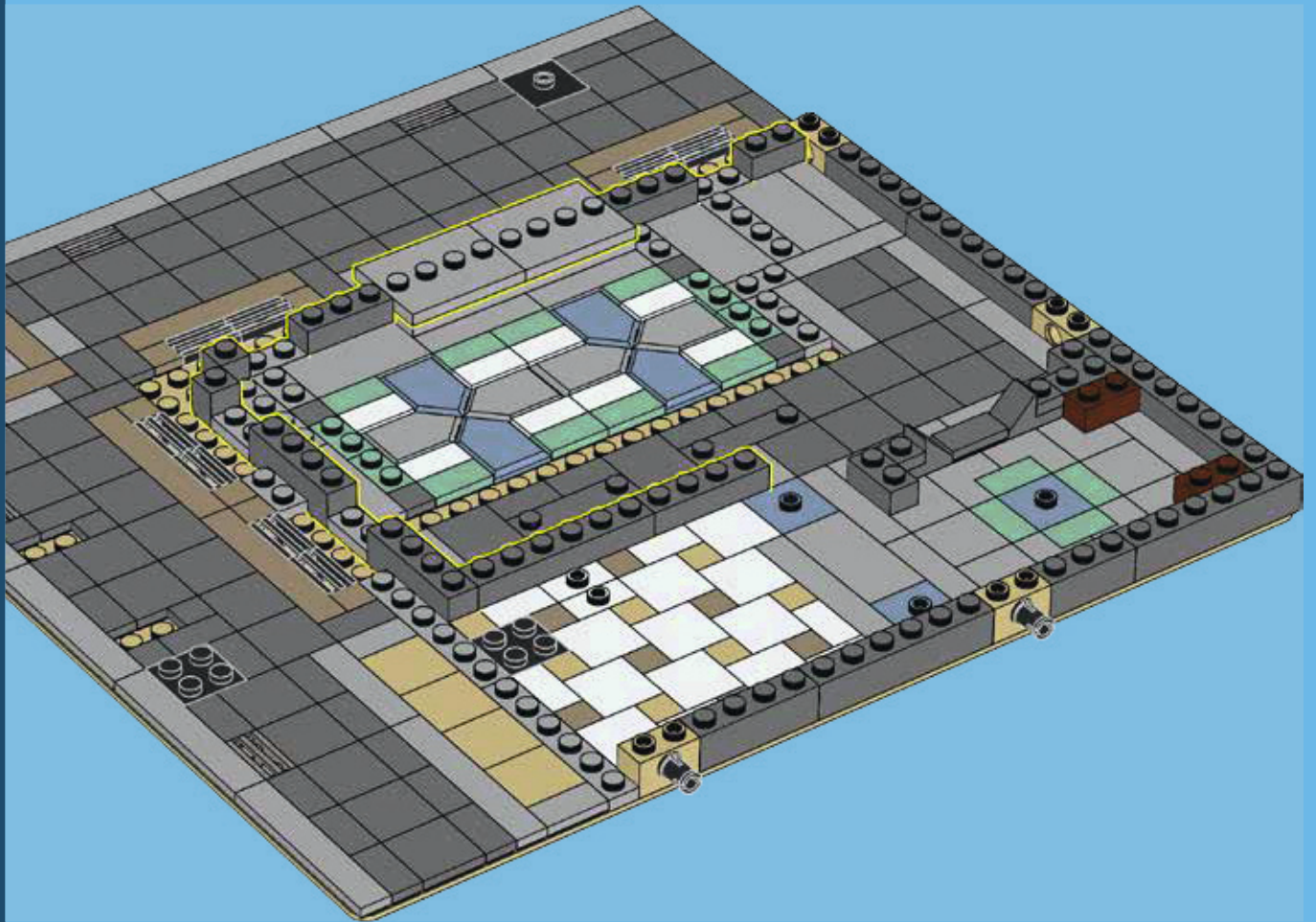



1x



5x



1x



2x



4x



4x



1x

13

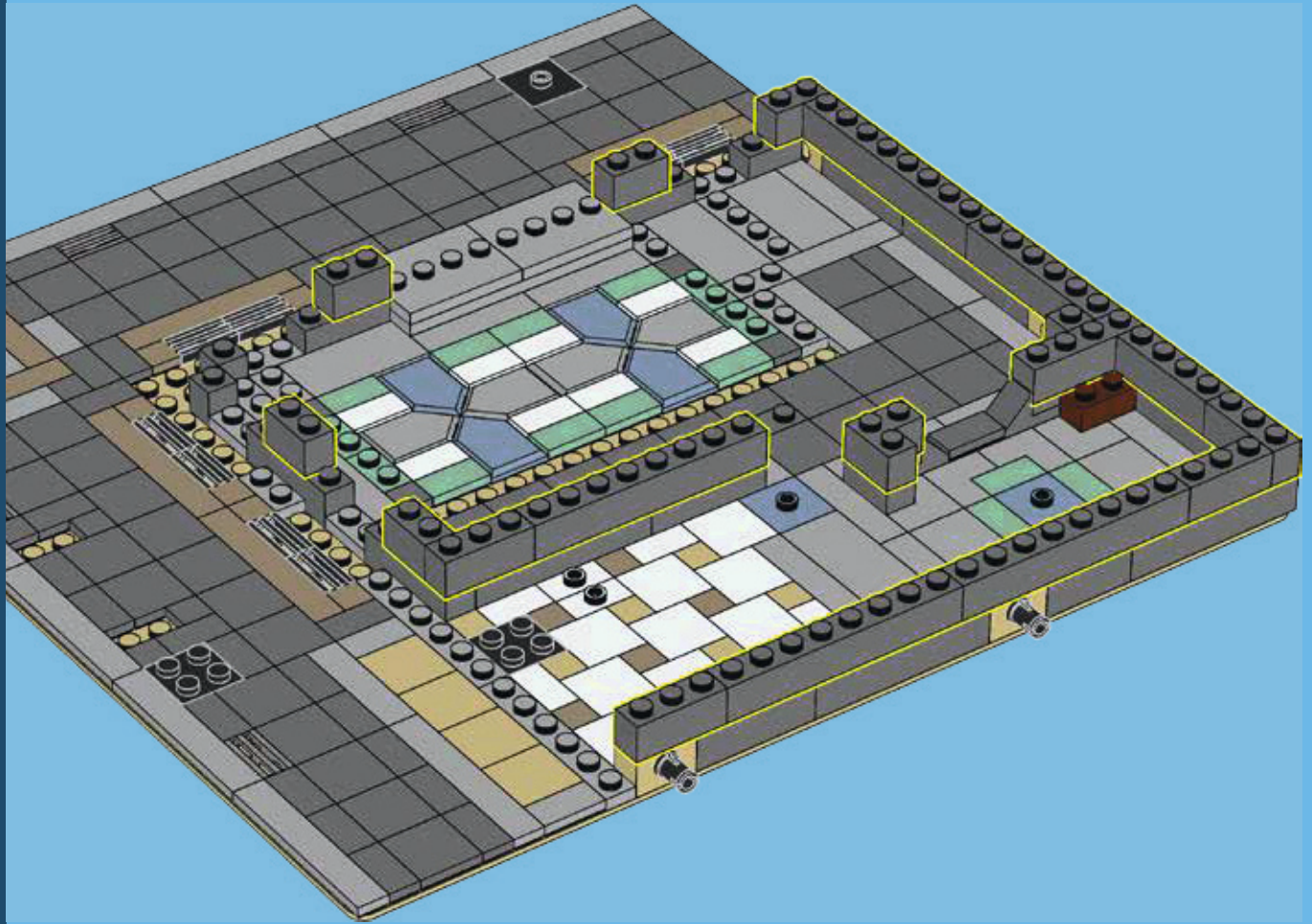

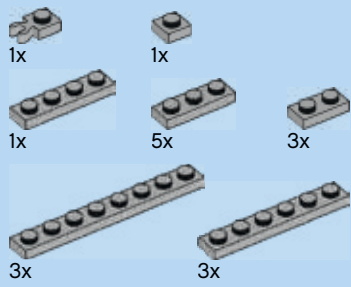

14

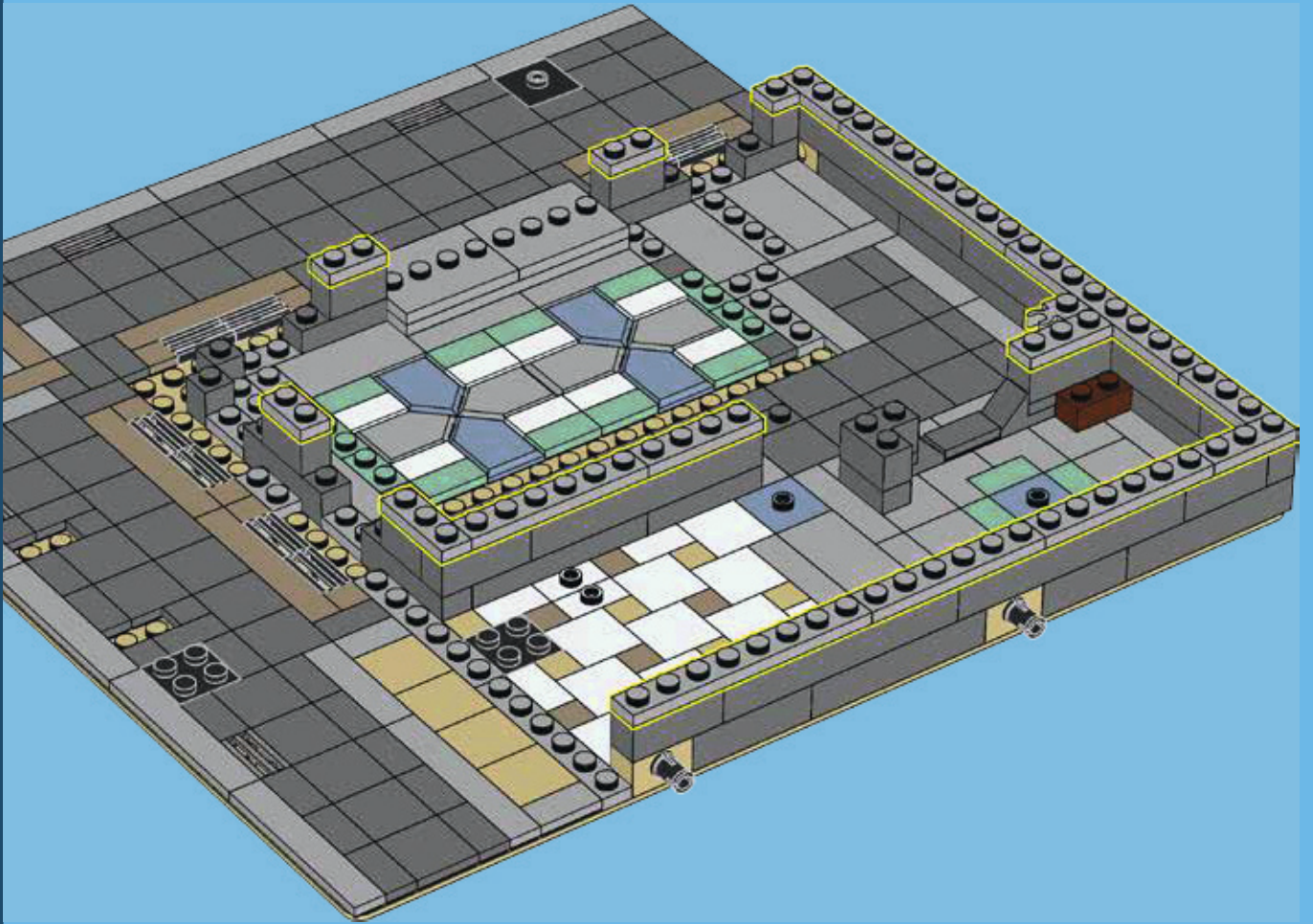

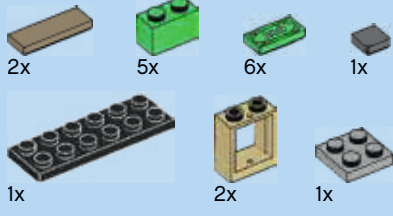

15

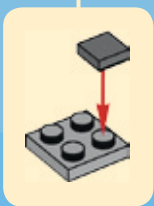
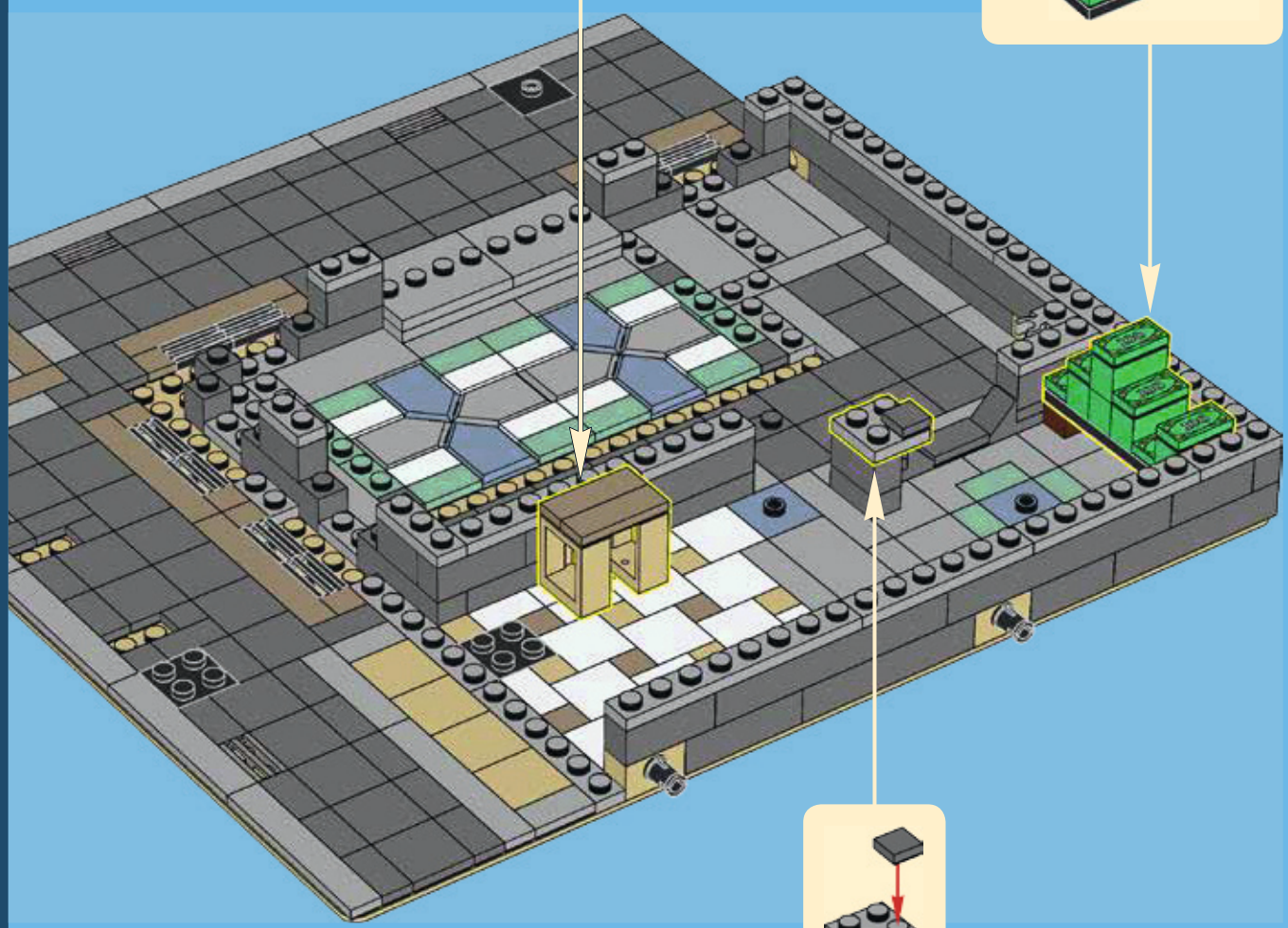
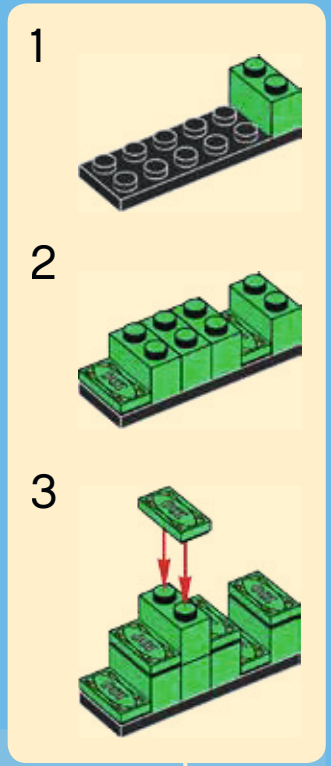
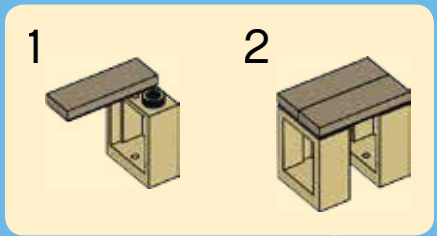

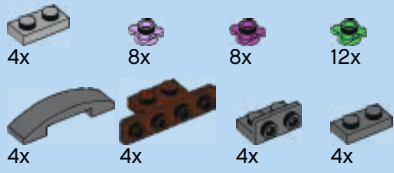

16

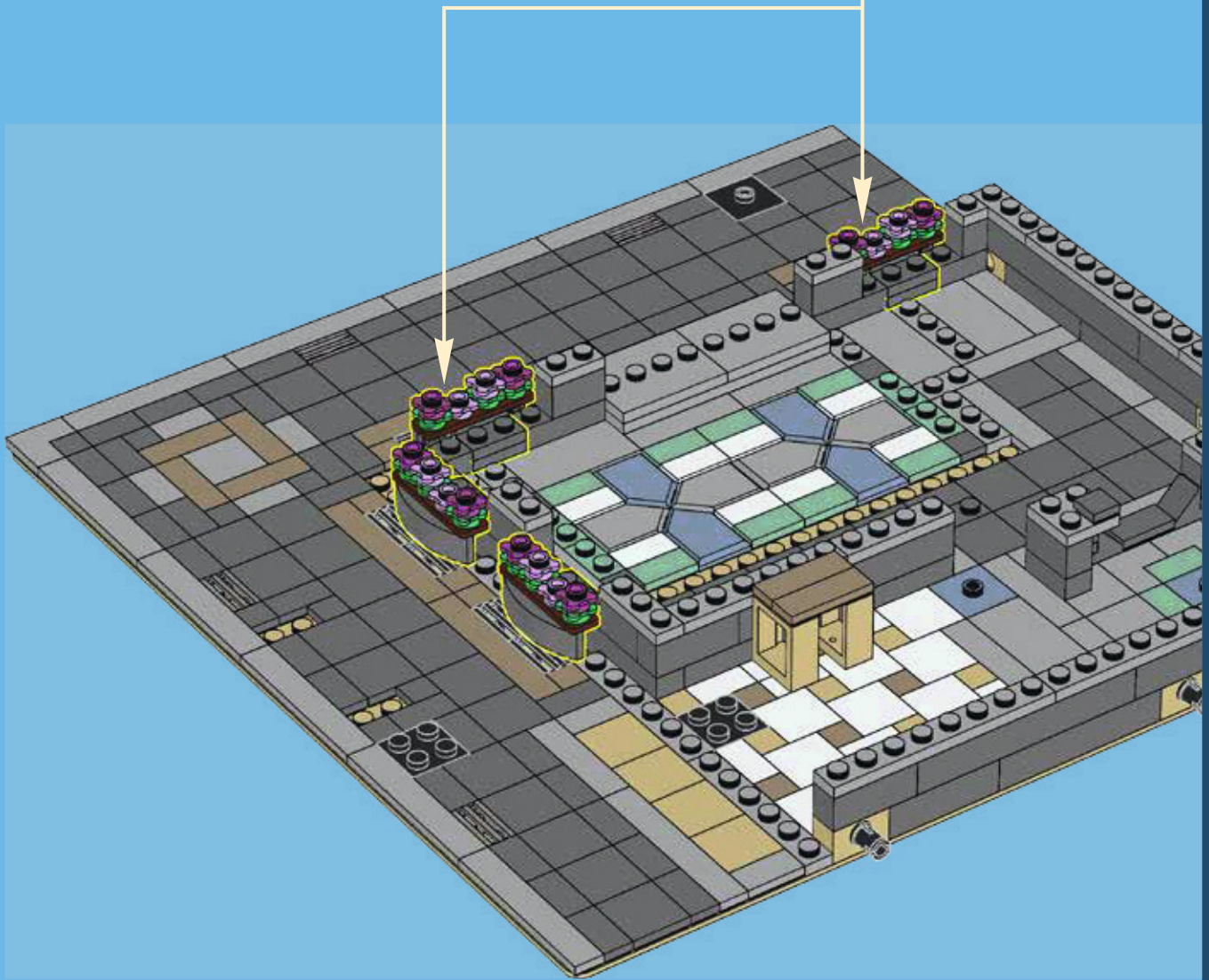
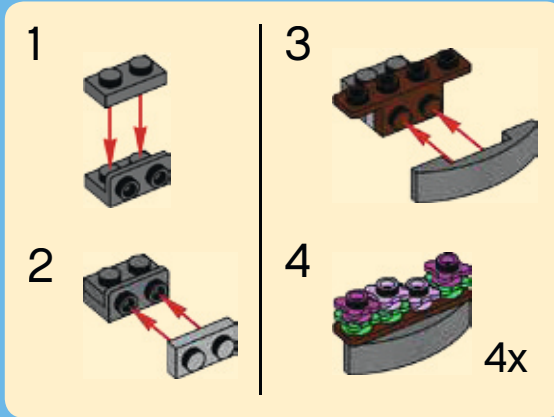

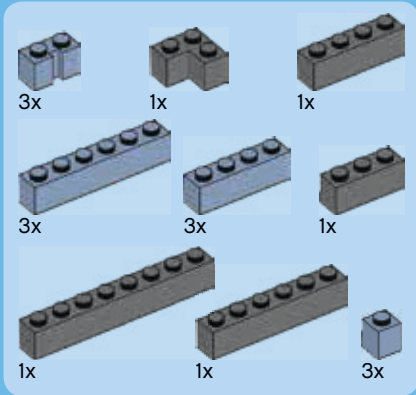

17

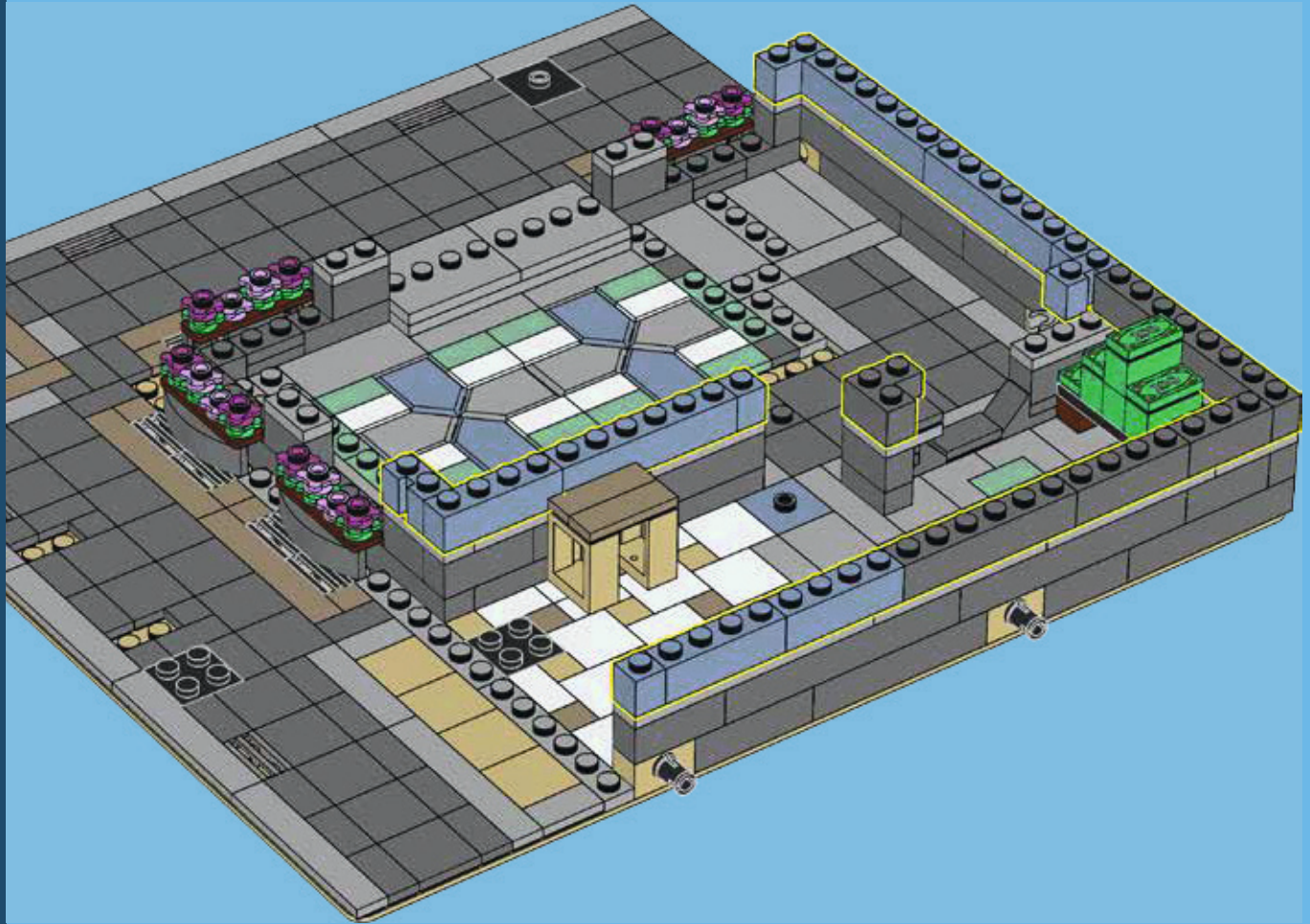



1x



2x



1x



1x



2x



1x



2x

18

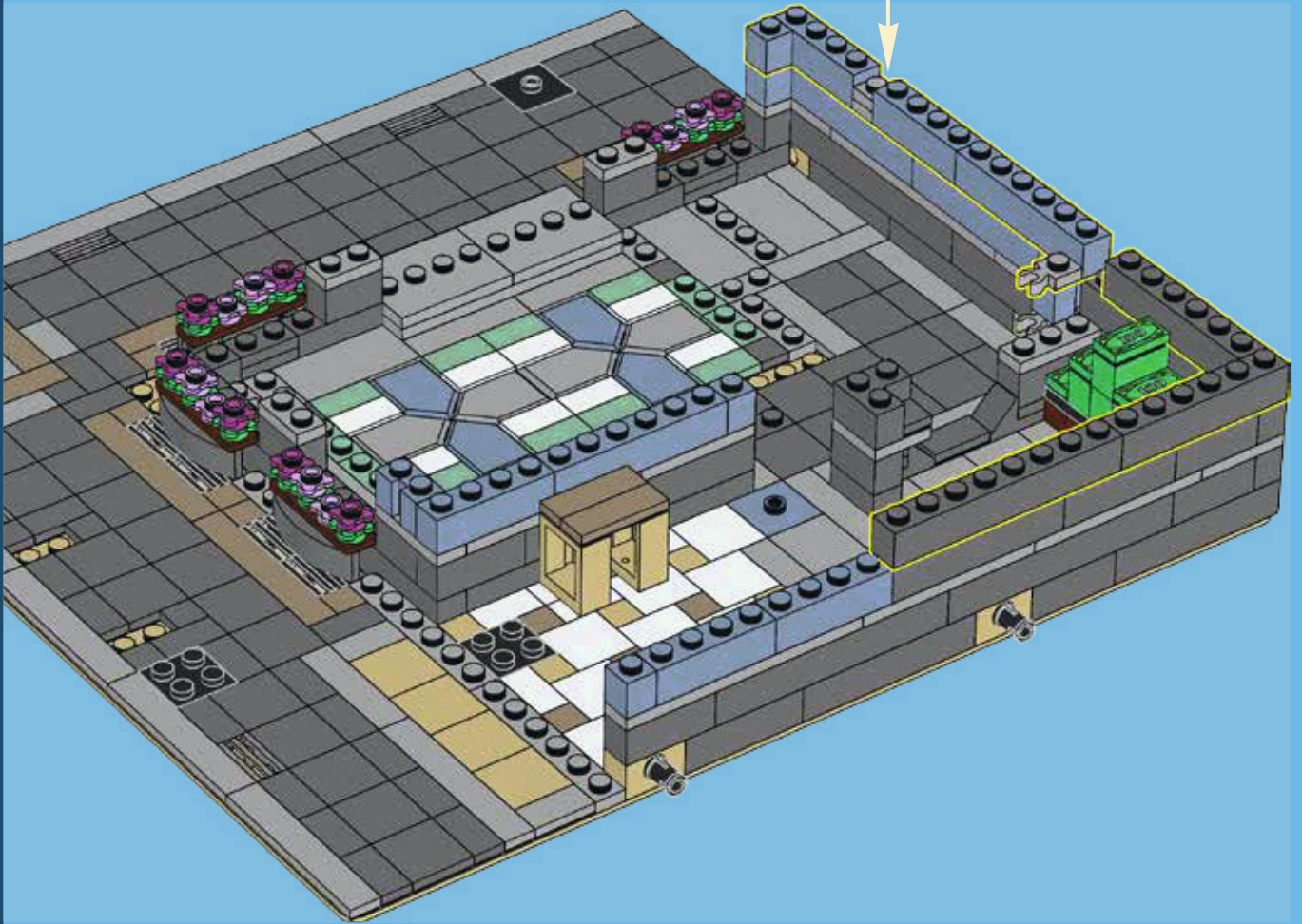
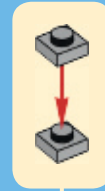



2x



19

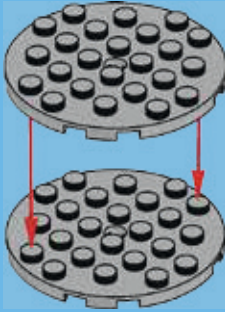

1x



1x

20

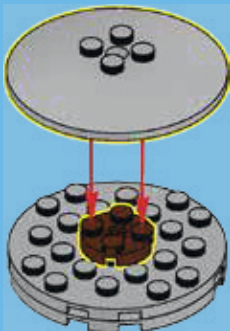

1x



1x

5

21

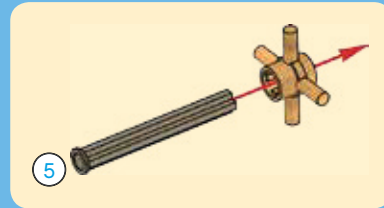

5

1:1

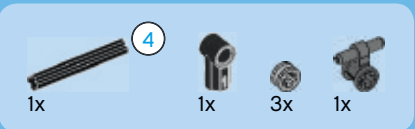

22

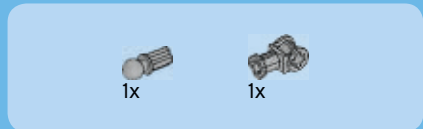
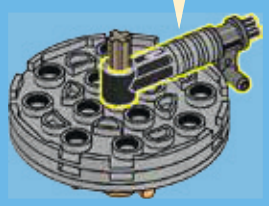
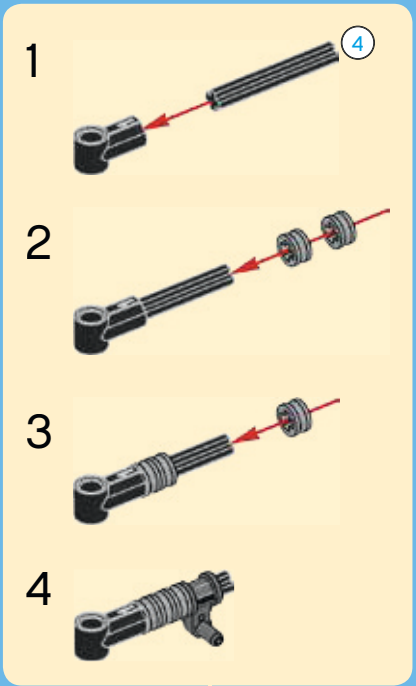

23

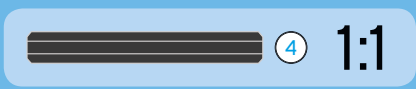
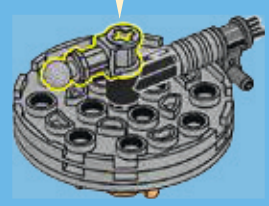
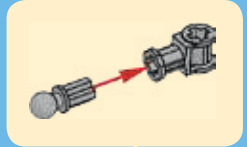

24

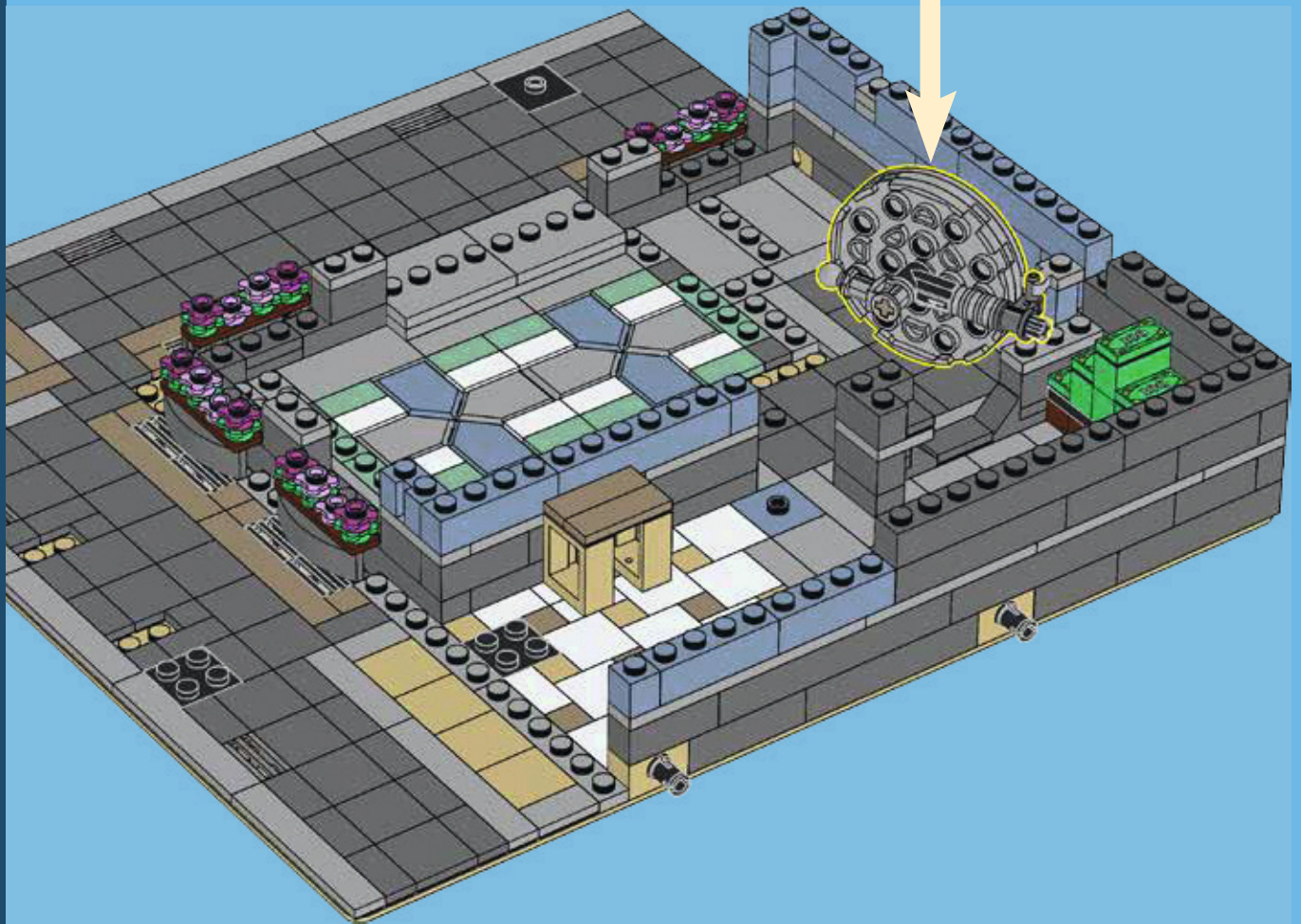

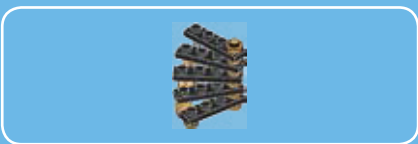

25

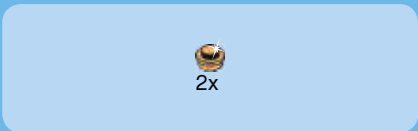
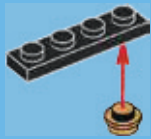

26

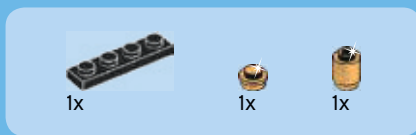

27

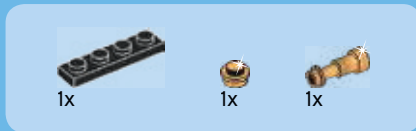
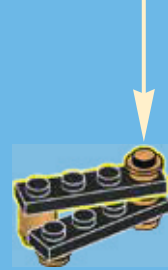
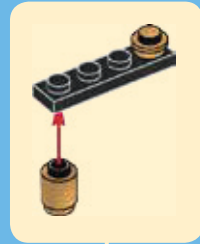

28

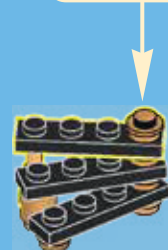
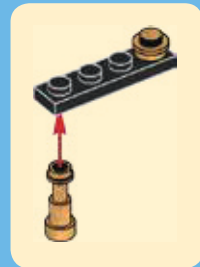

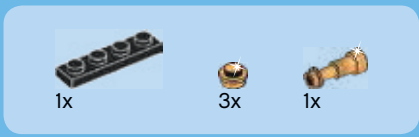

29

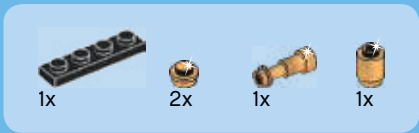

30



31

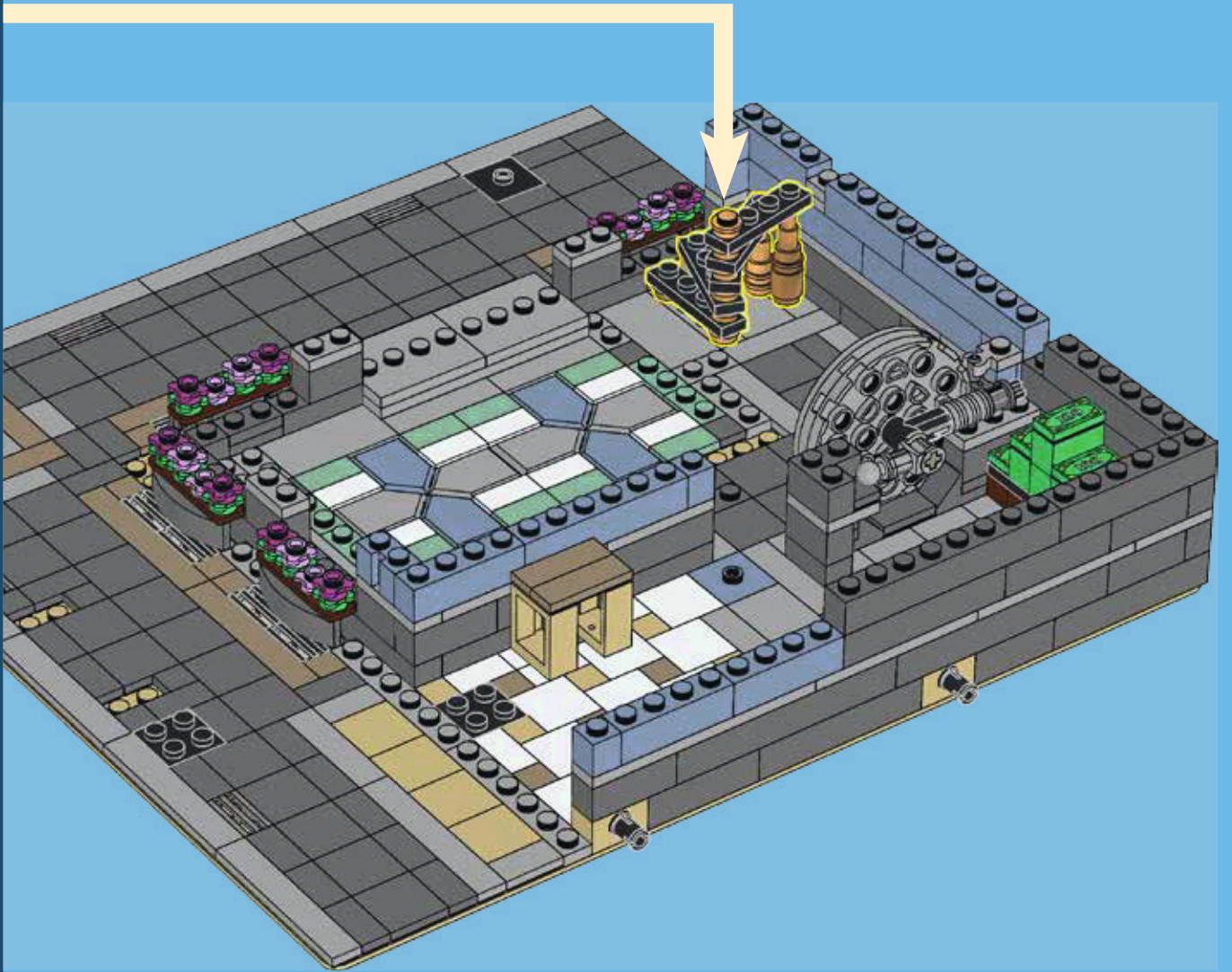

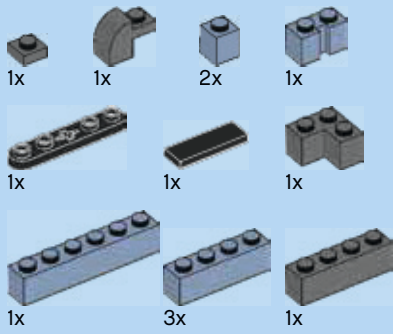

32

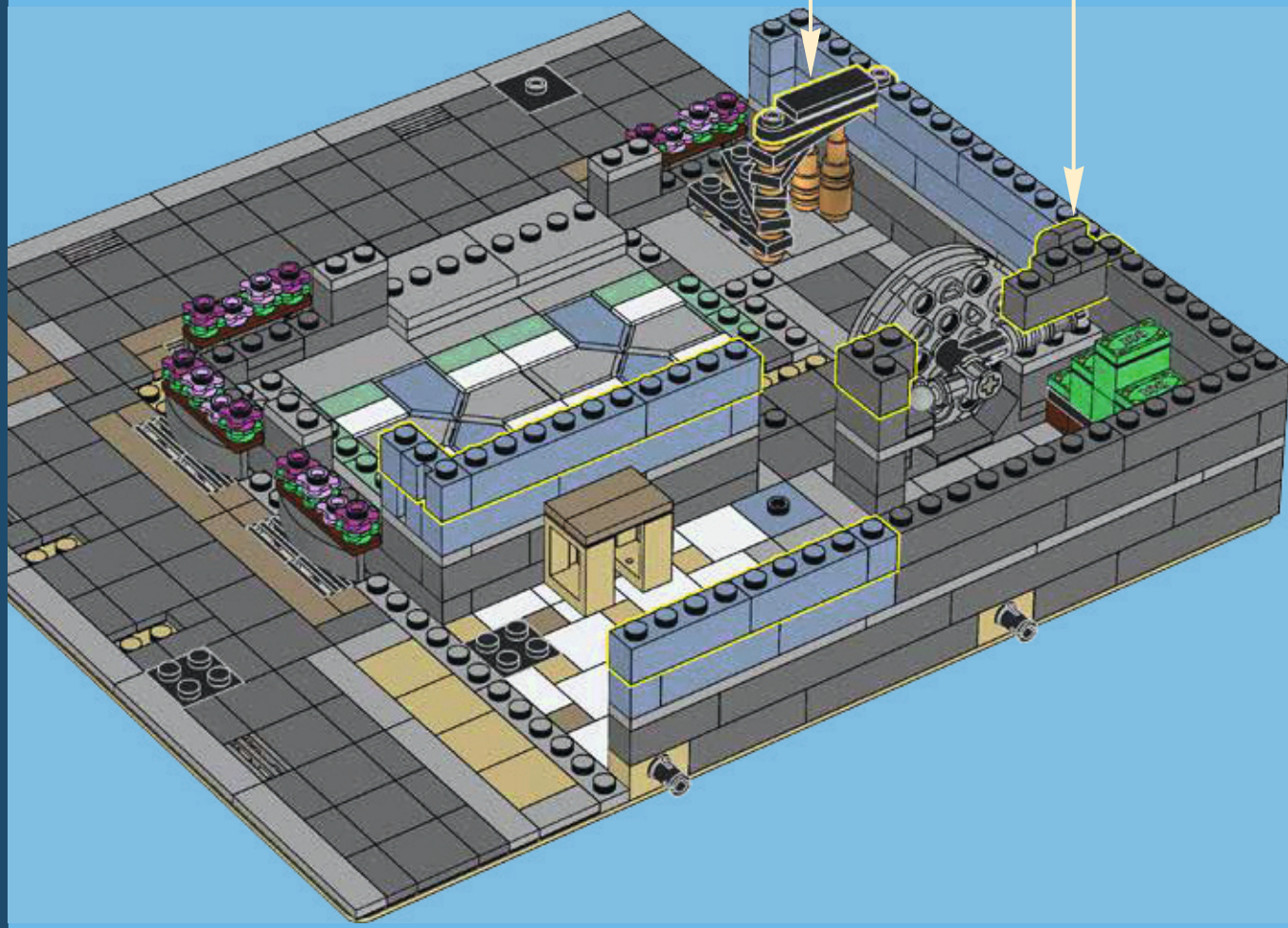
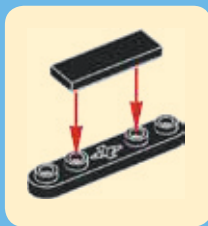
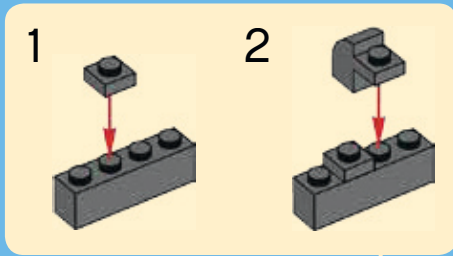

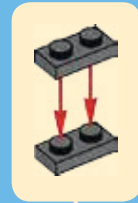
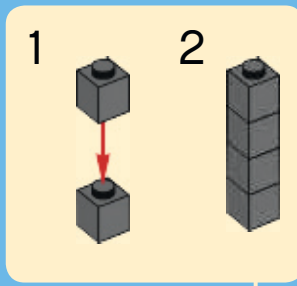
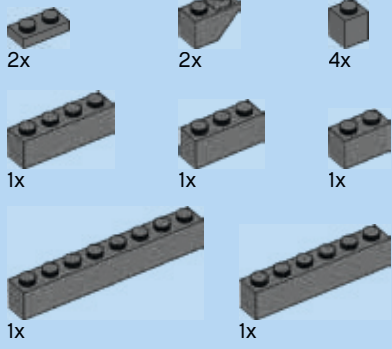

33

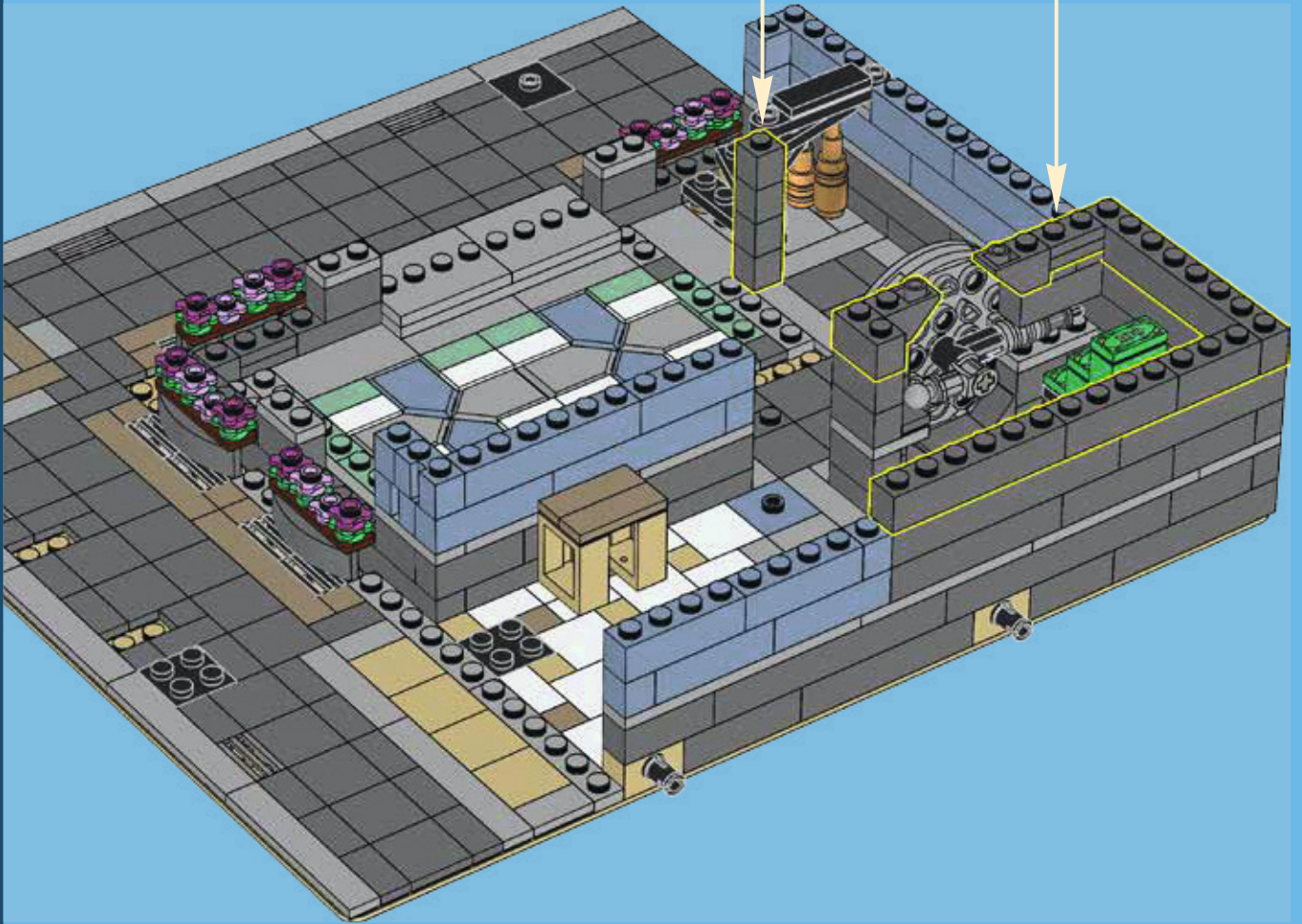



1x



4x



2x



7x

34

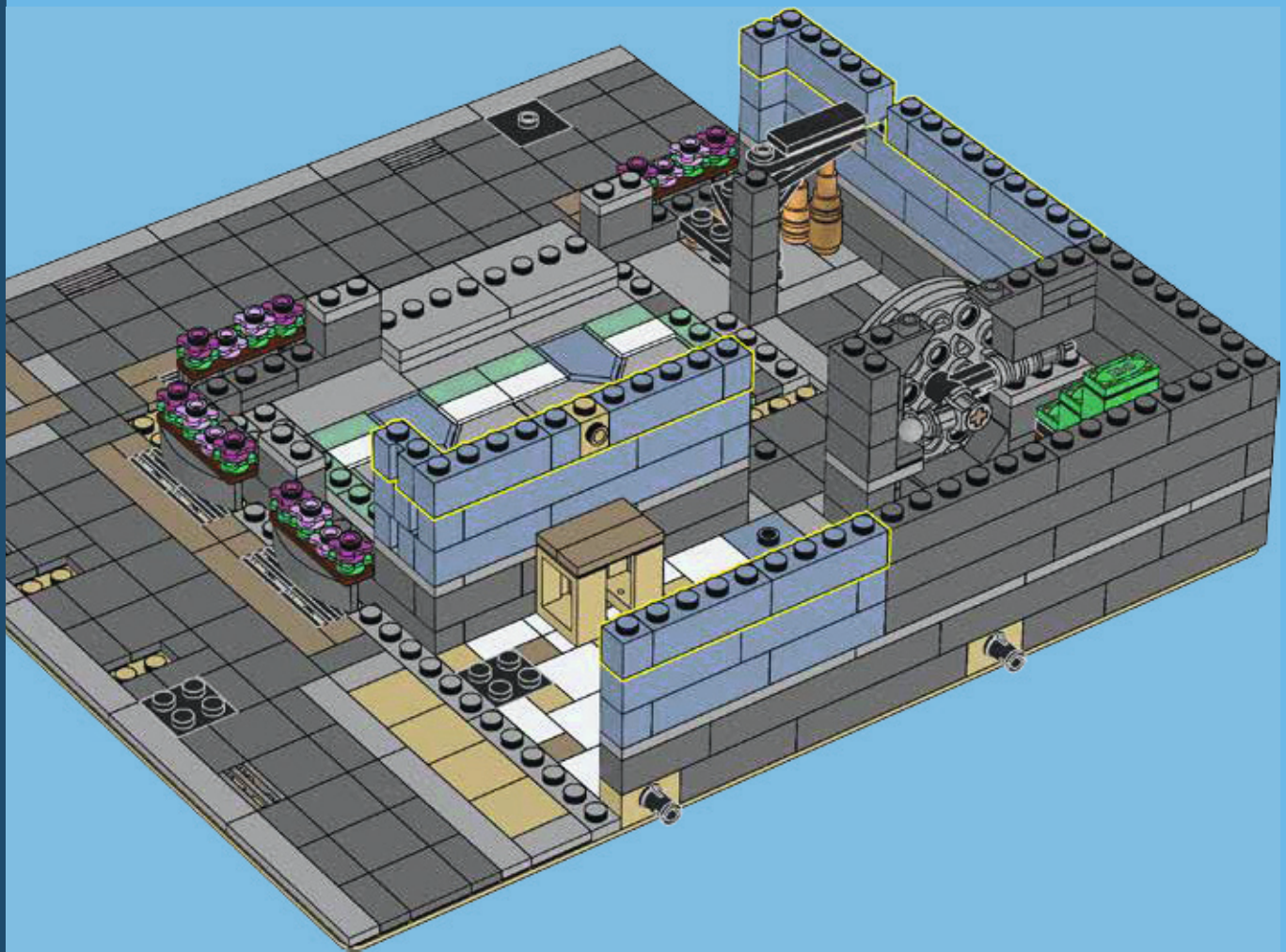



1x



1x

35

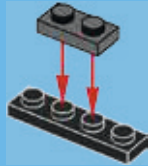

2x

36

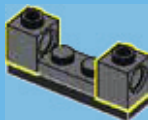

2x

37

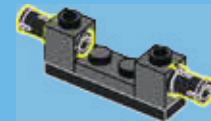

2x

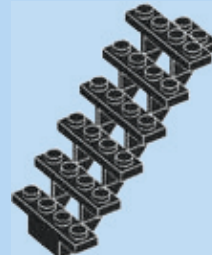

1x

38

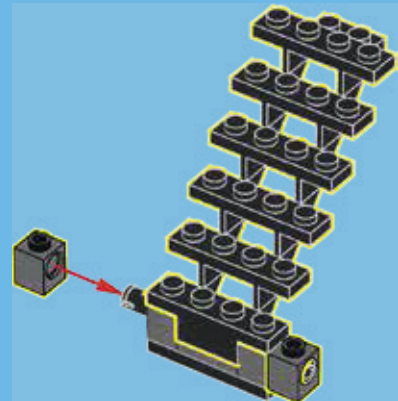

39

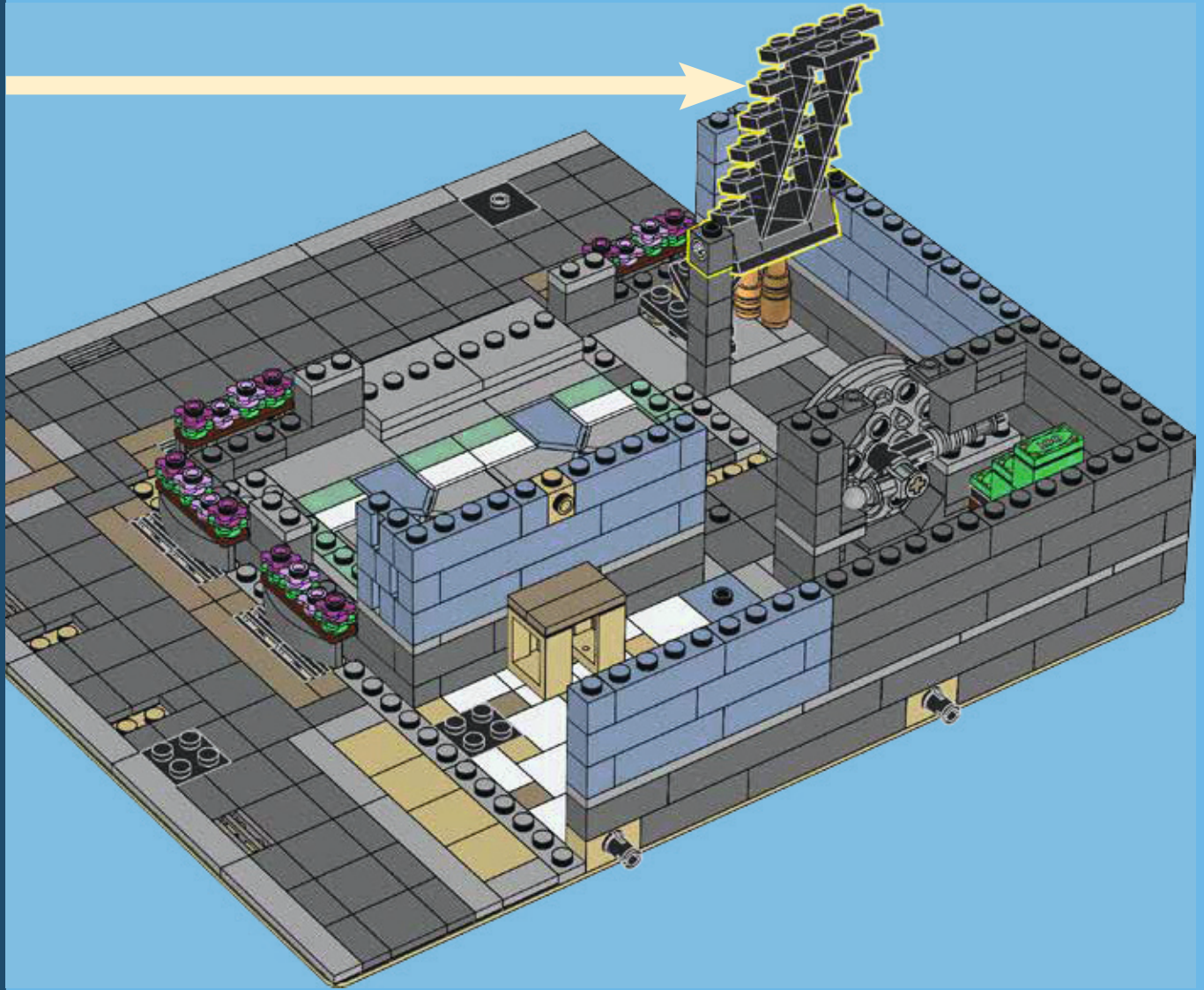

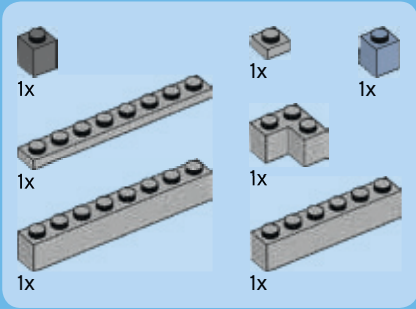

40

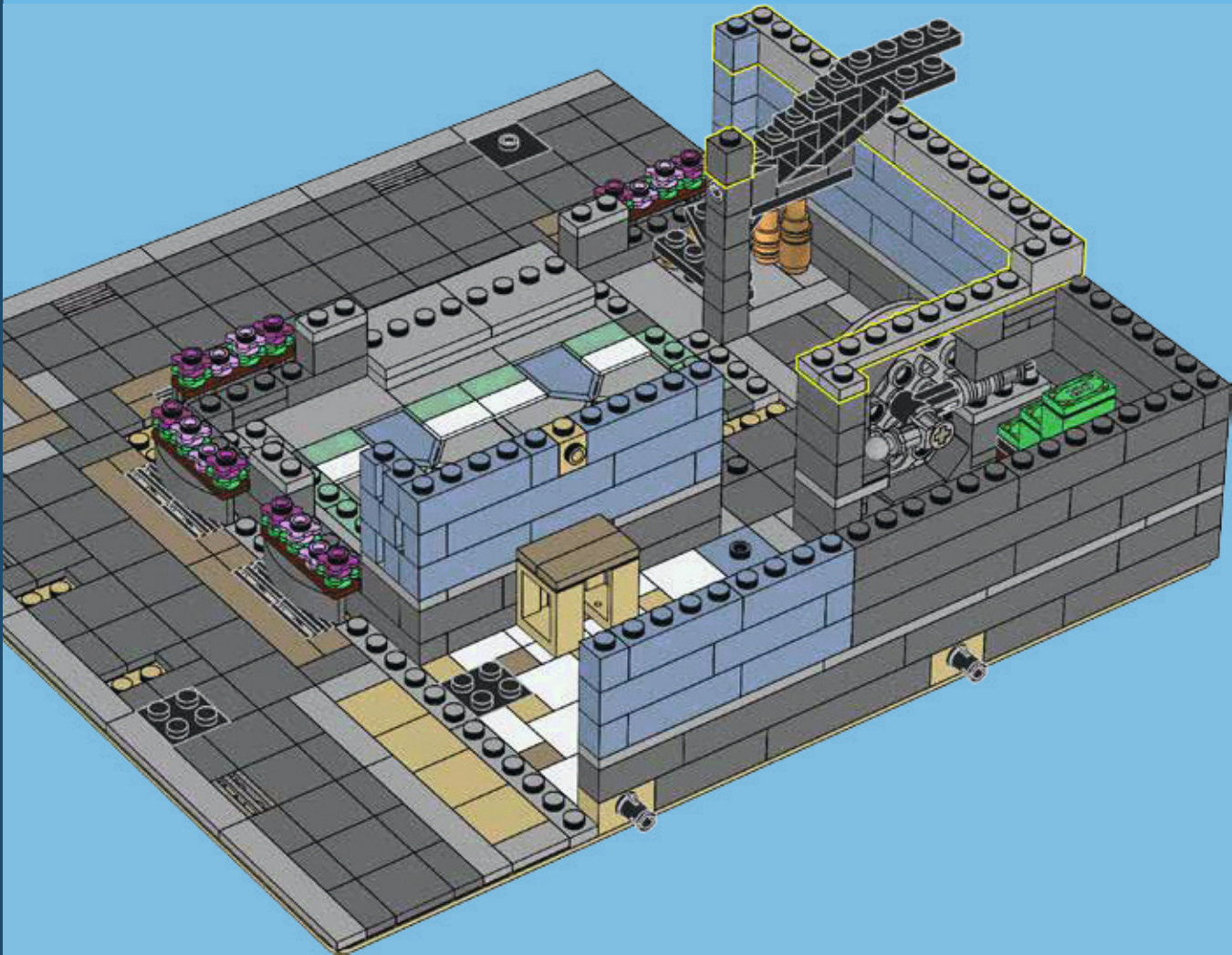

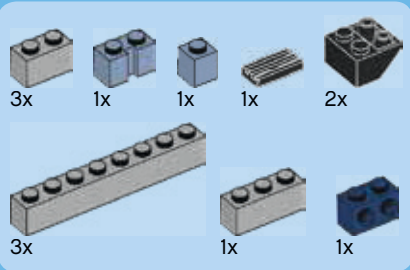

41

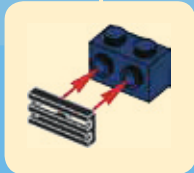
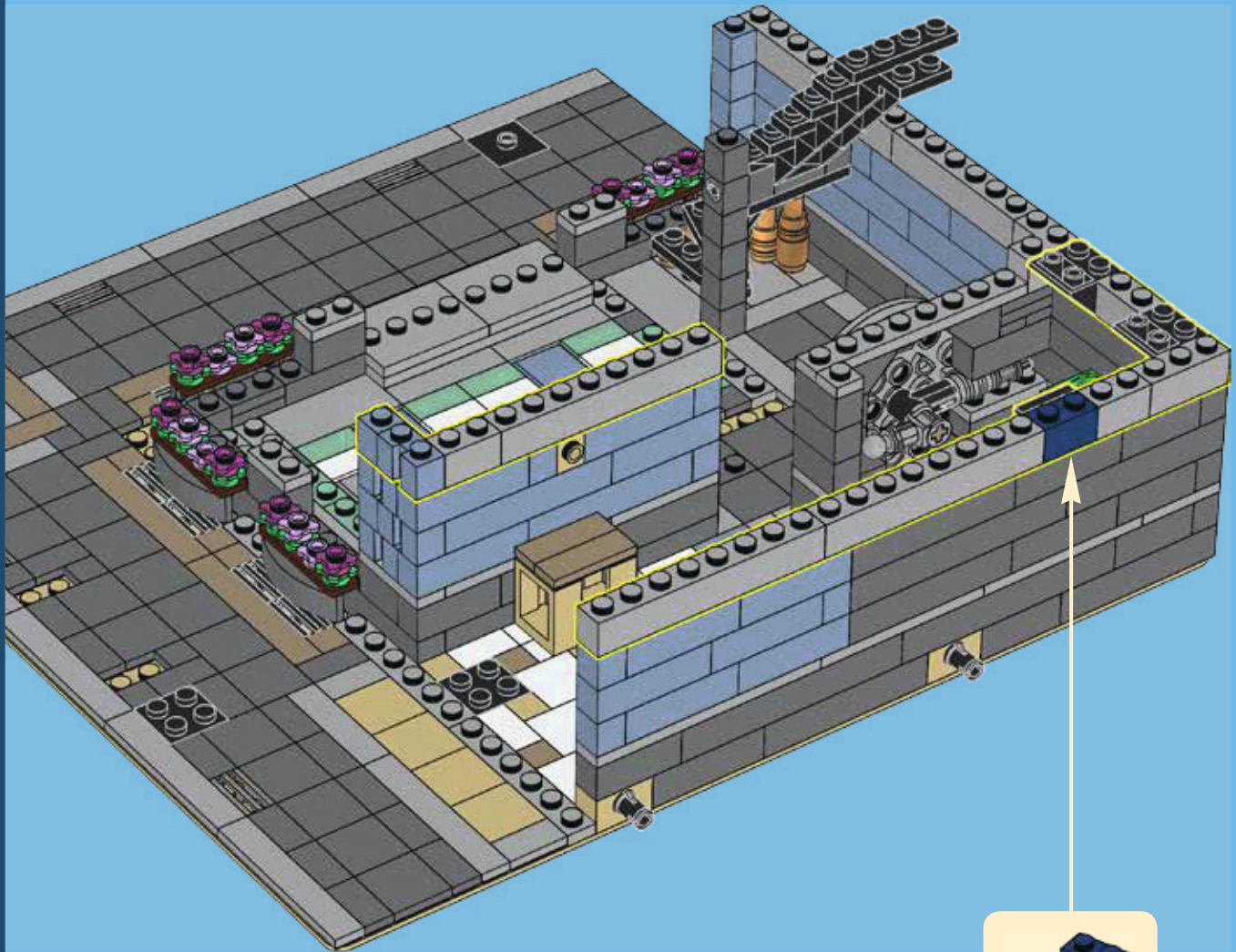

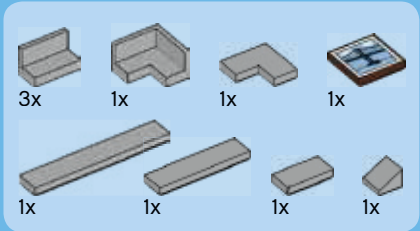

43



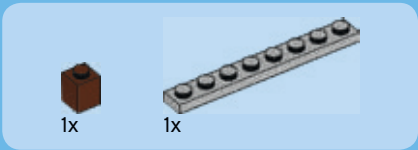
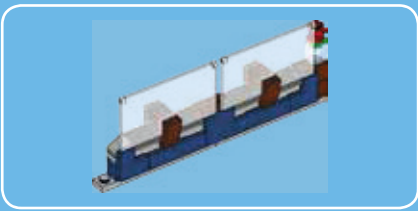

44

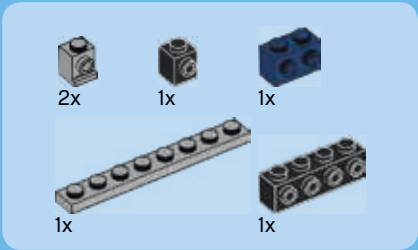
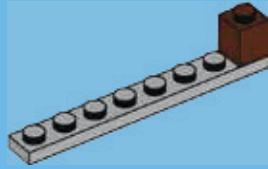

45

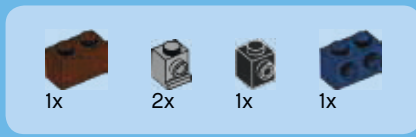
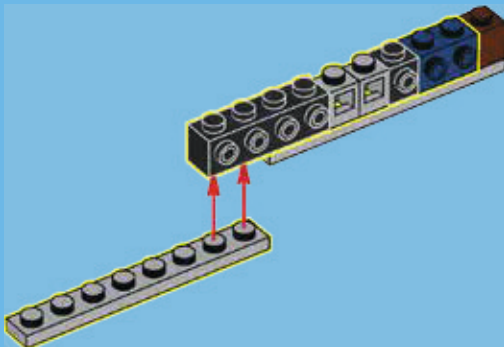

46

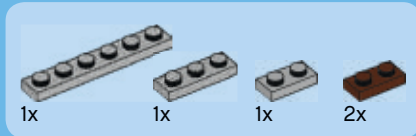
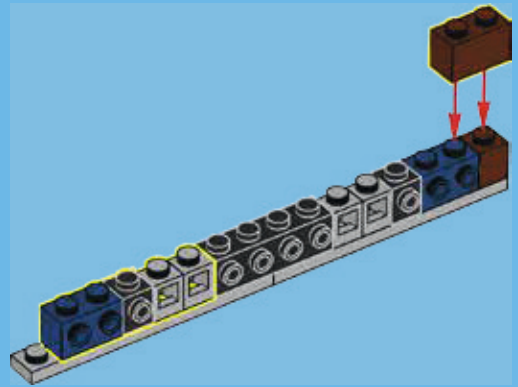

47

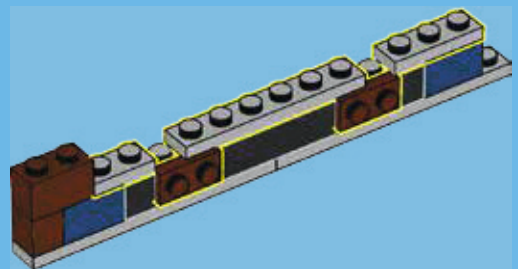



48

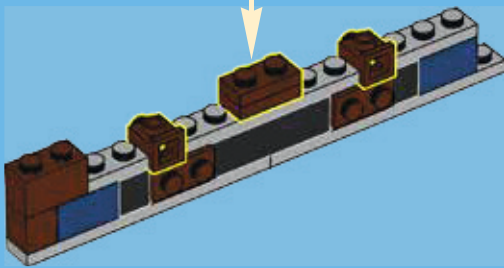
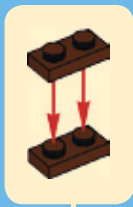

50

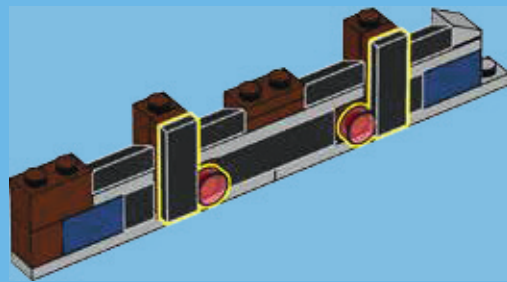

49

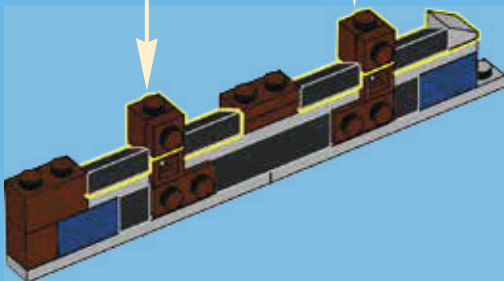
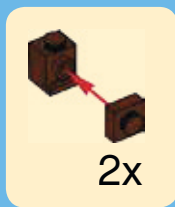

51

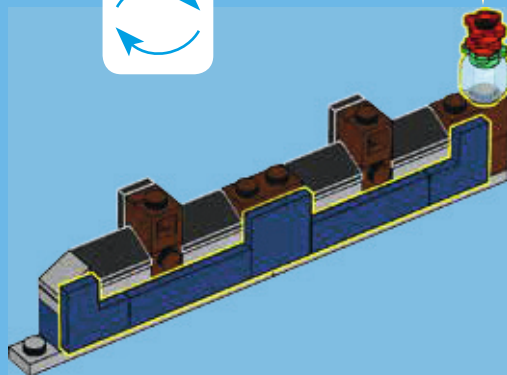



52

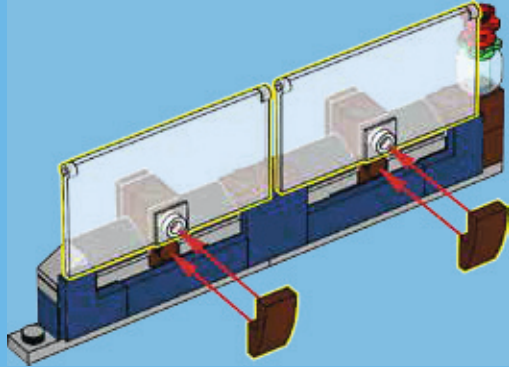

53



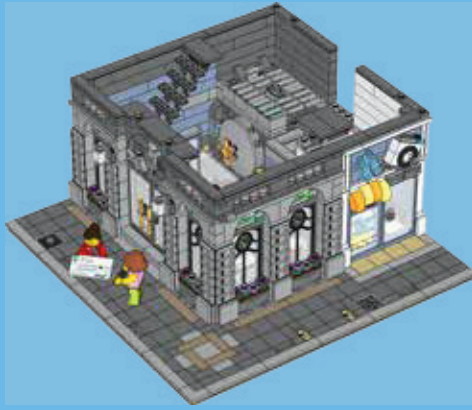
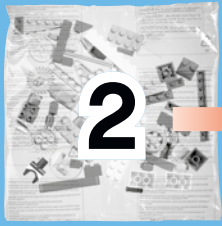

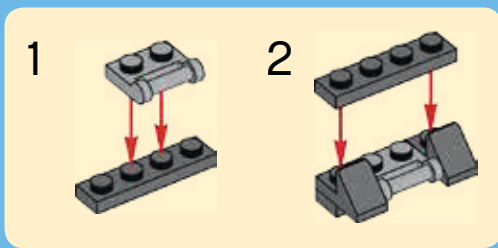
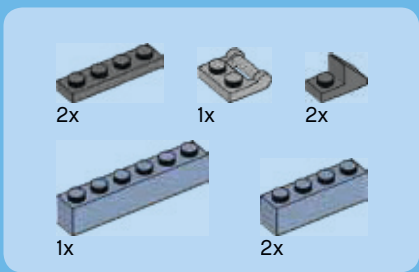

55

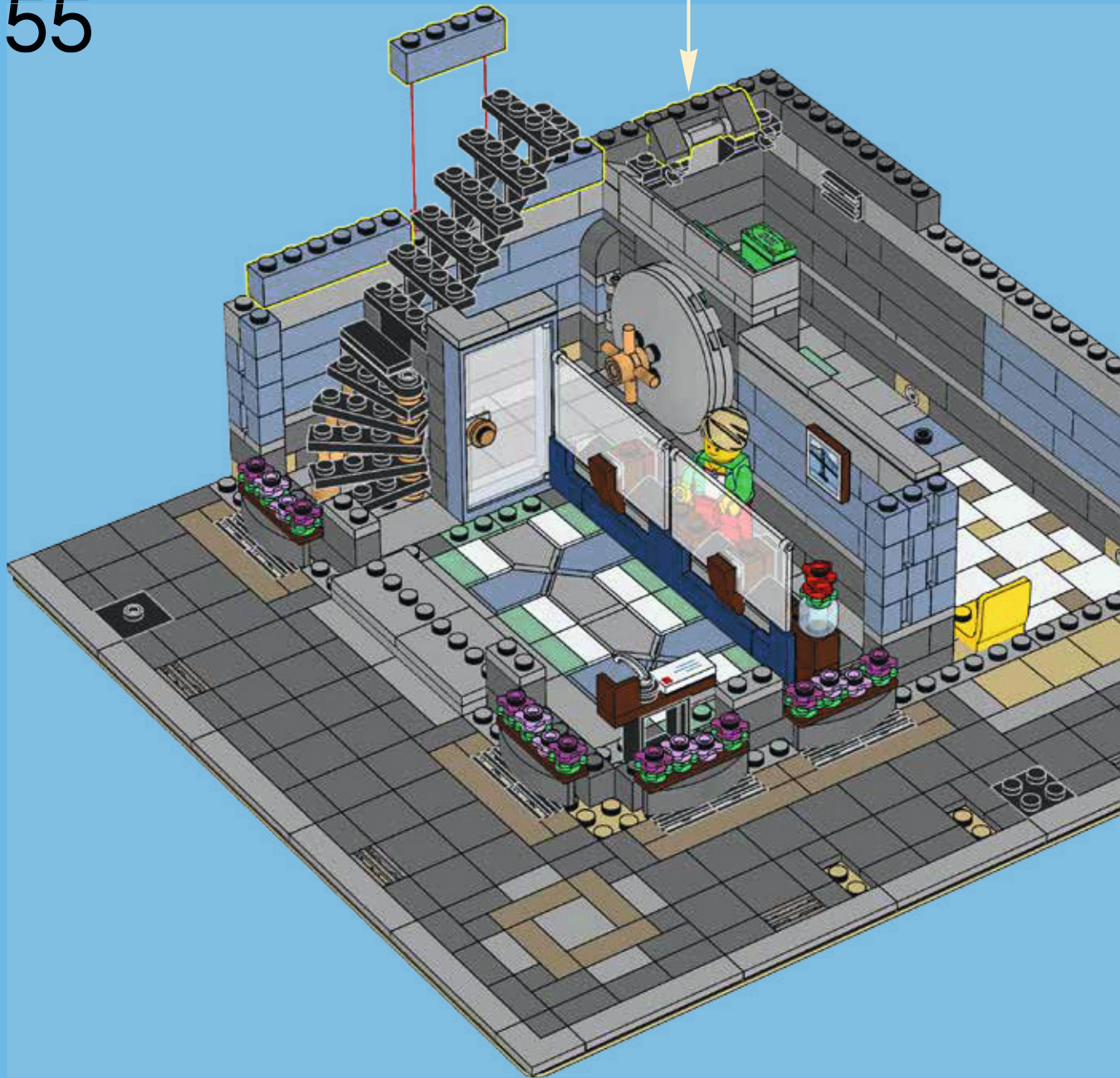

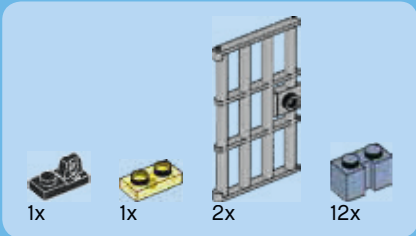

56

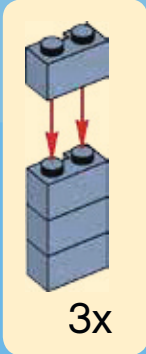
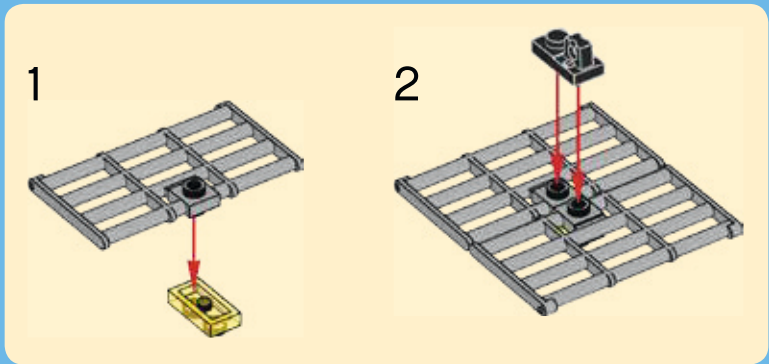

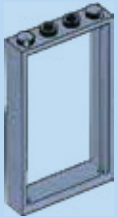

1x



1x

57

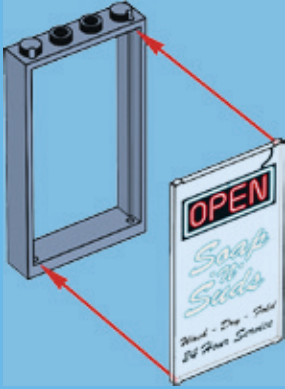

1x



1x



1x

58



2x



1x



1x

59



1x

60





2x



10x



5x

61





1x

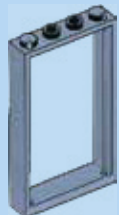

1x

62

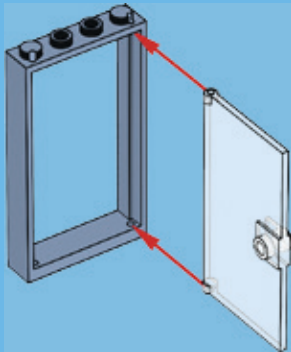

1x



1x

63

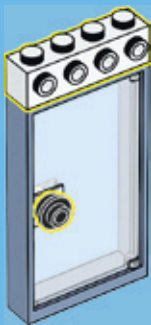

2x

64

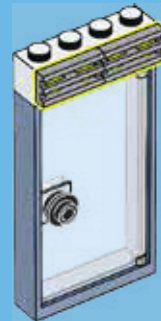

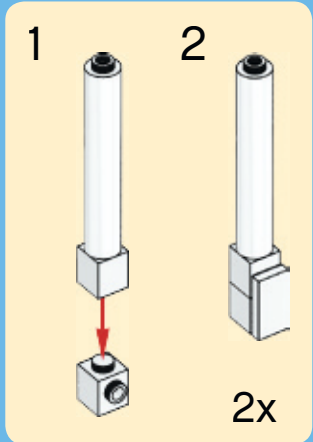
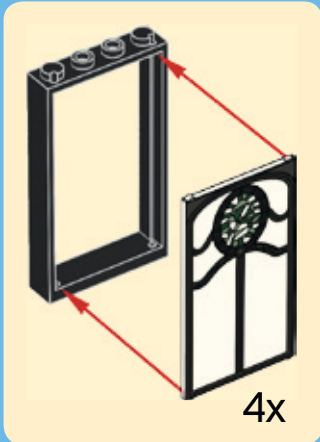
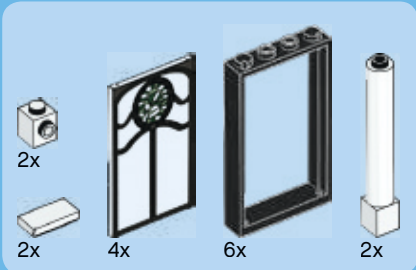

65

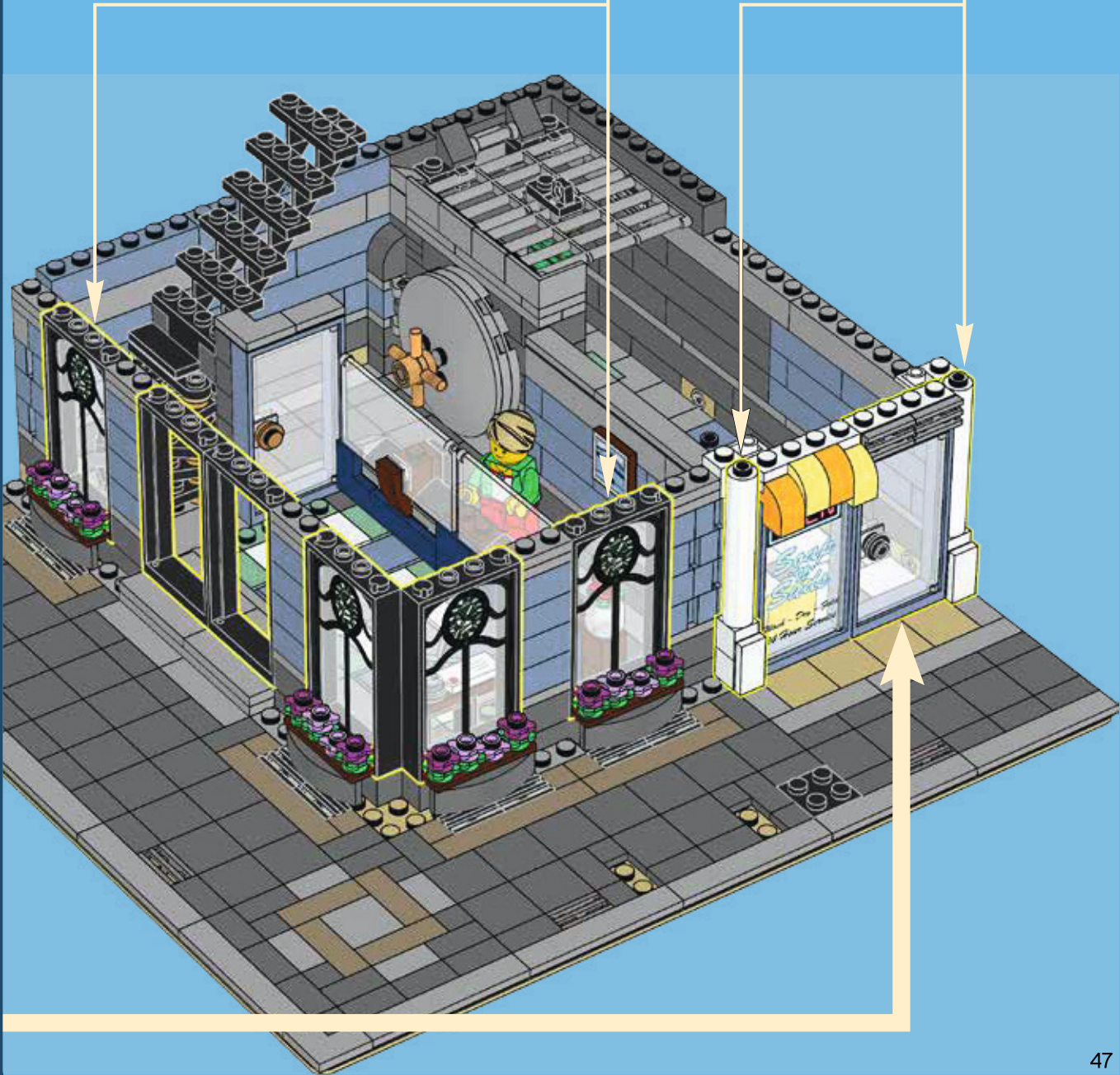



5x



5x



20x



30x

66

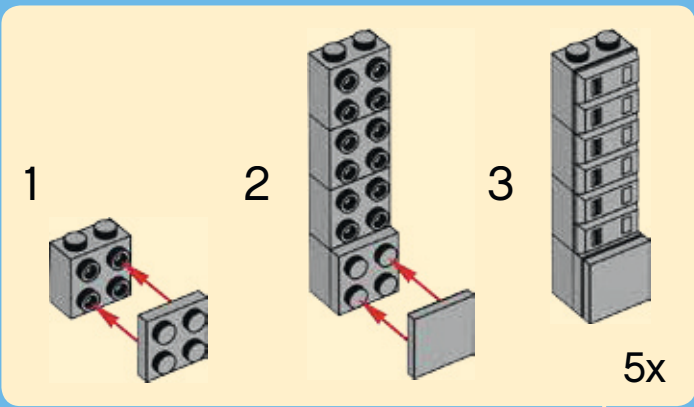



67

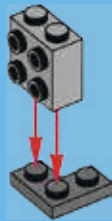

68

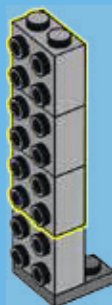

69

1

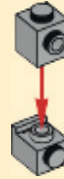

2



70





2x



1x

71

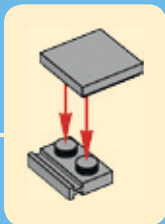
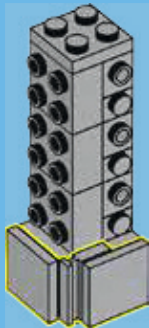

12x

72

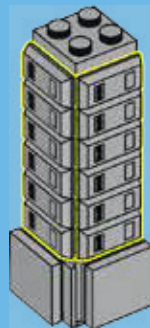

73



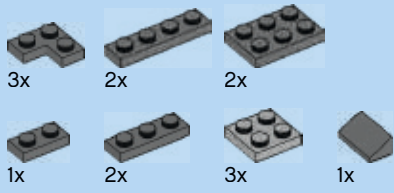

74



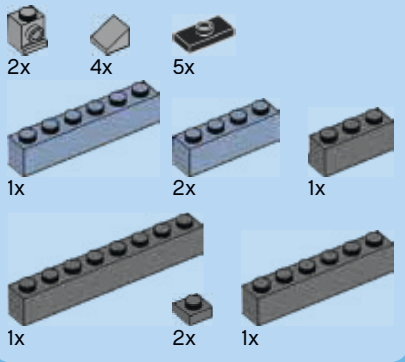

75

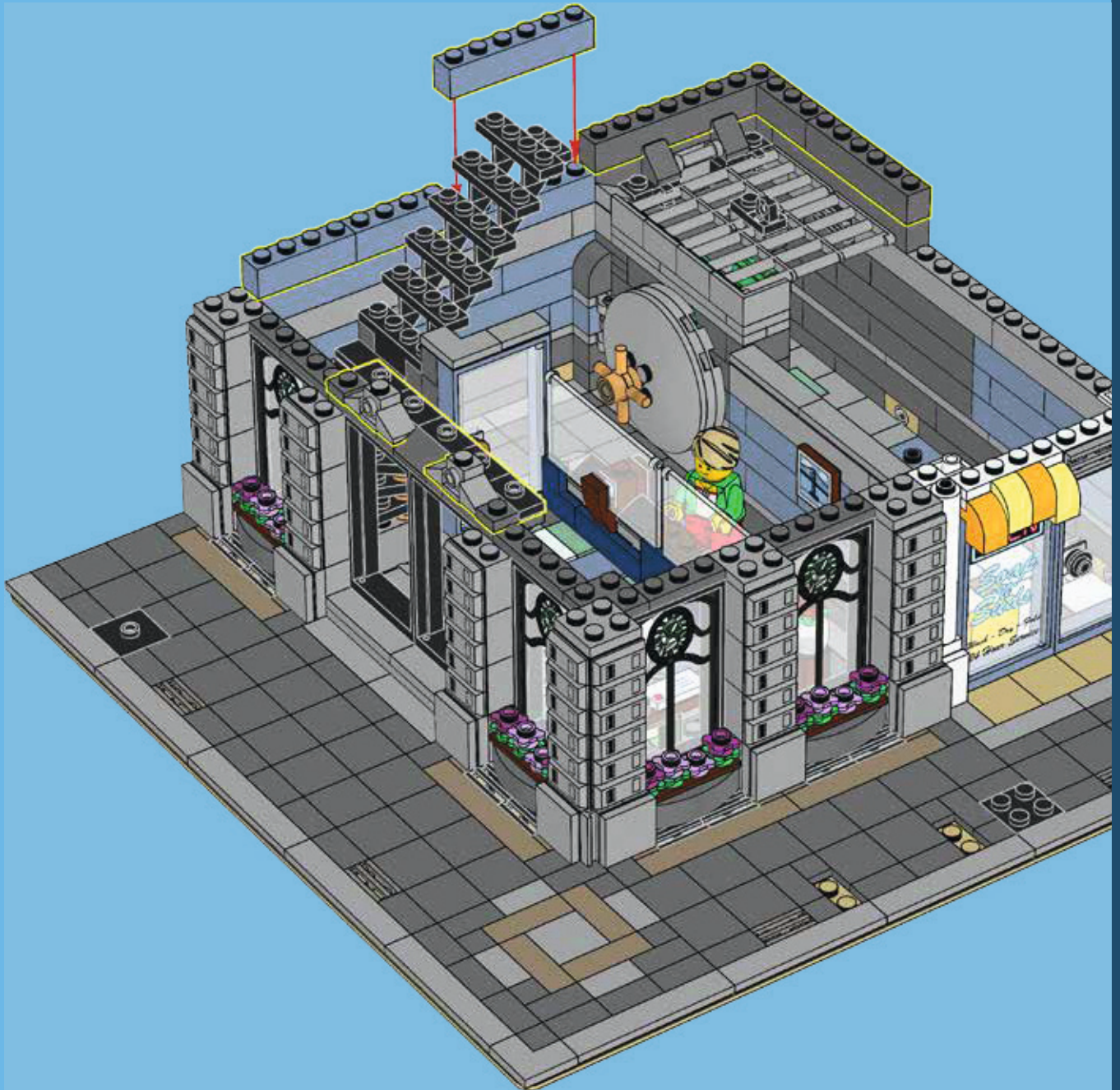

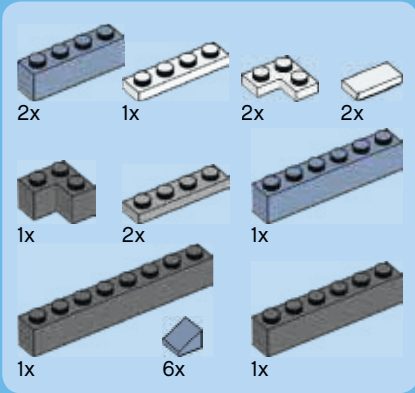

76

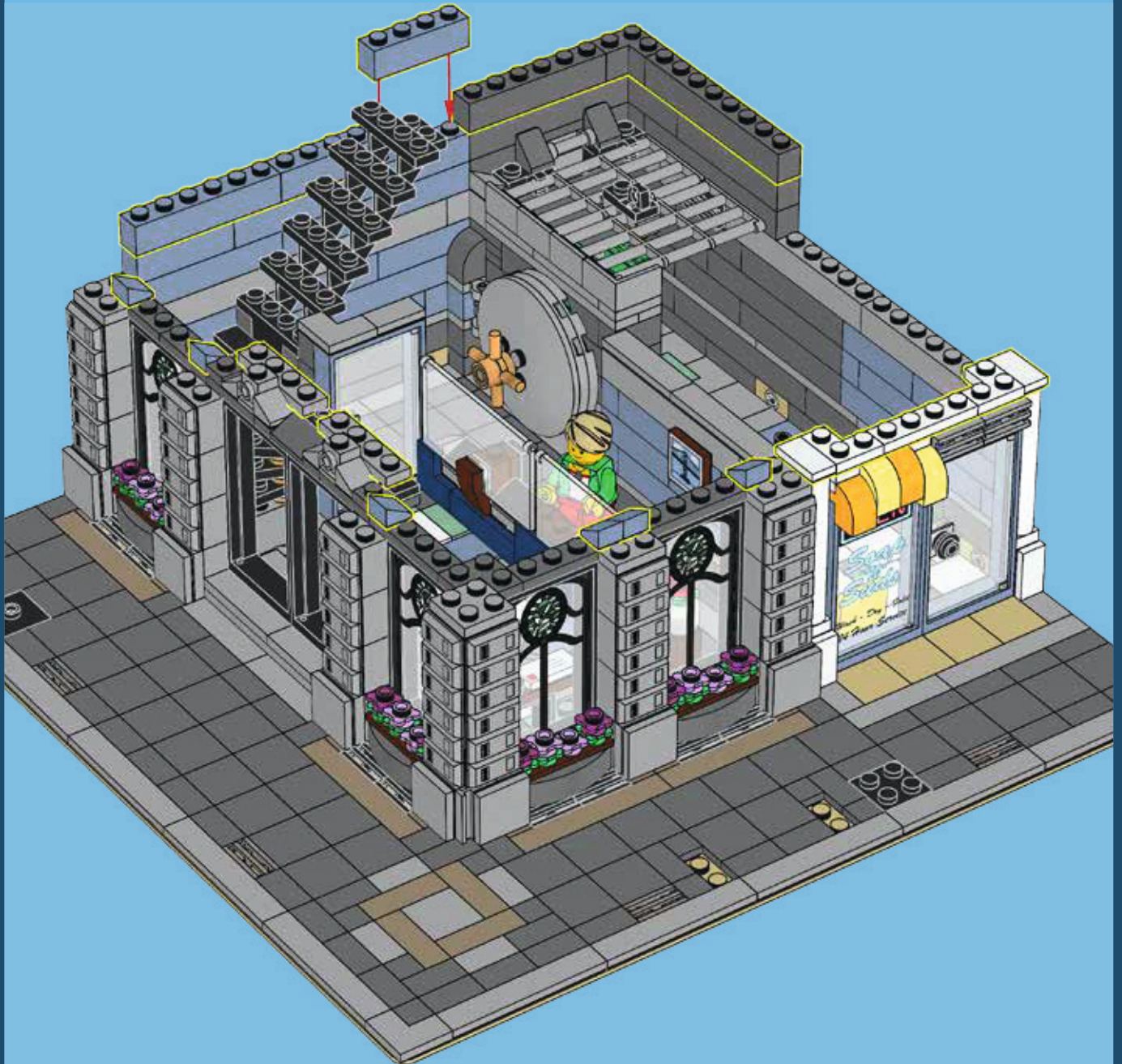

77

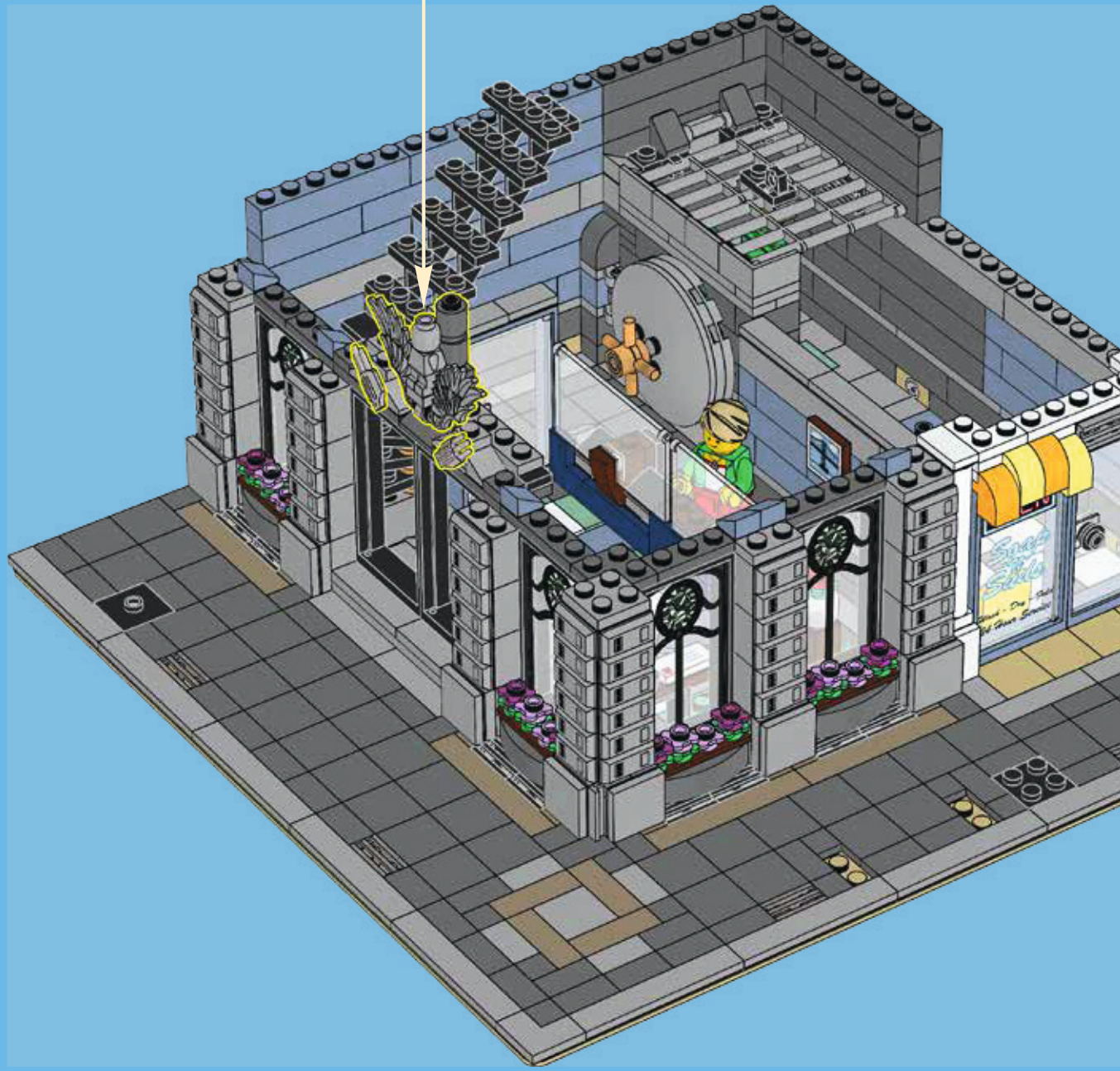
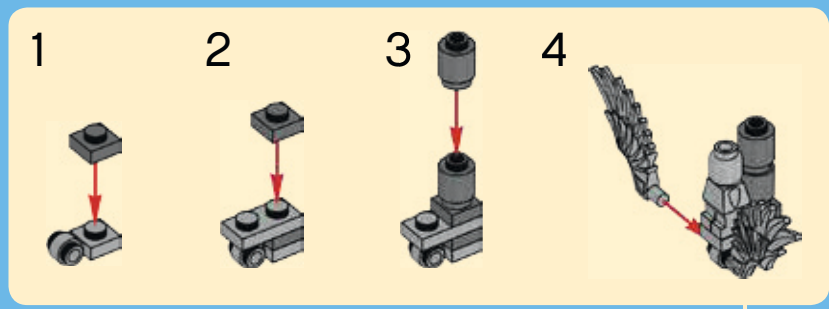
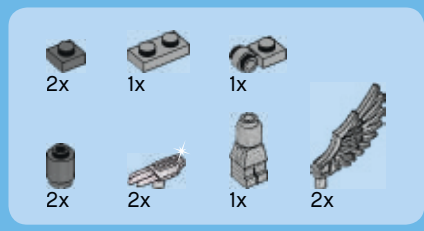

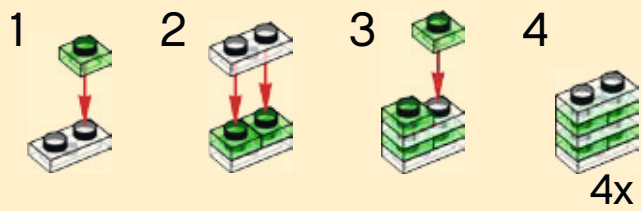
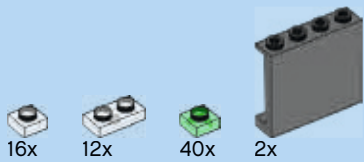

78

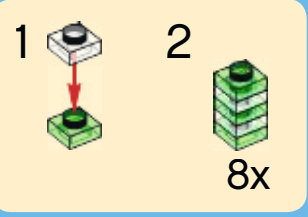
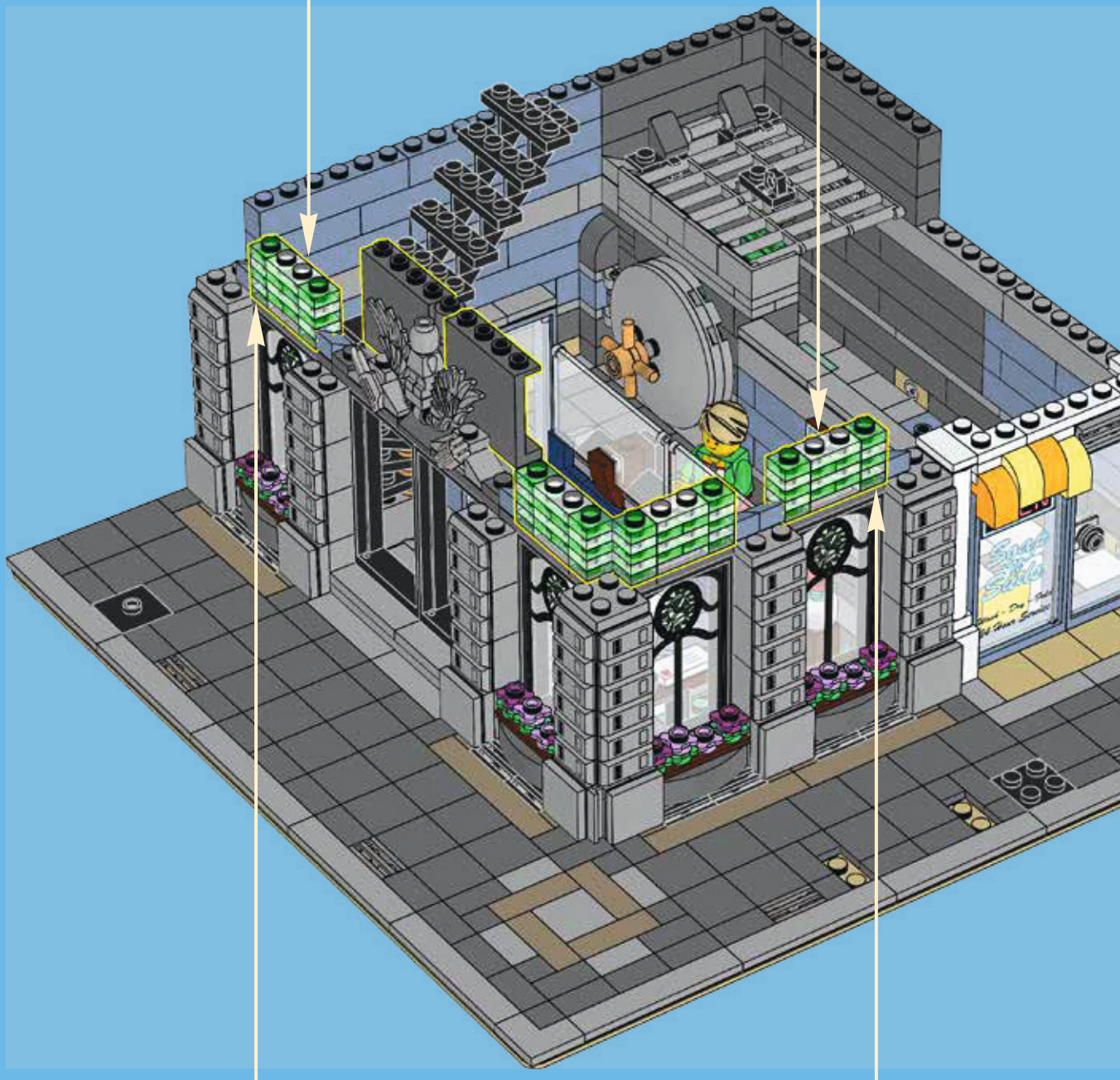

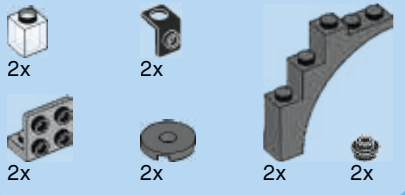

79

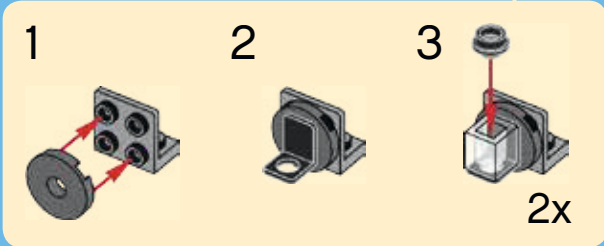
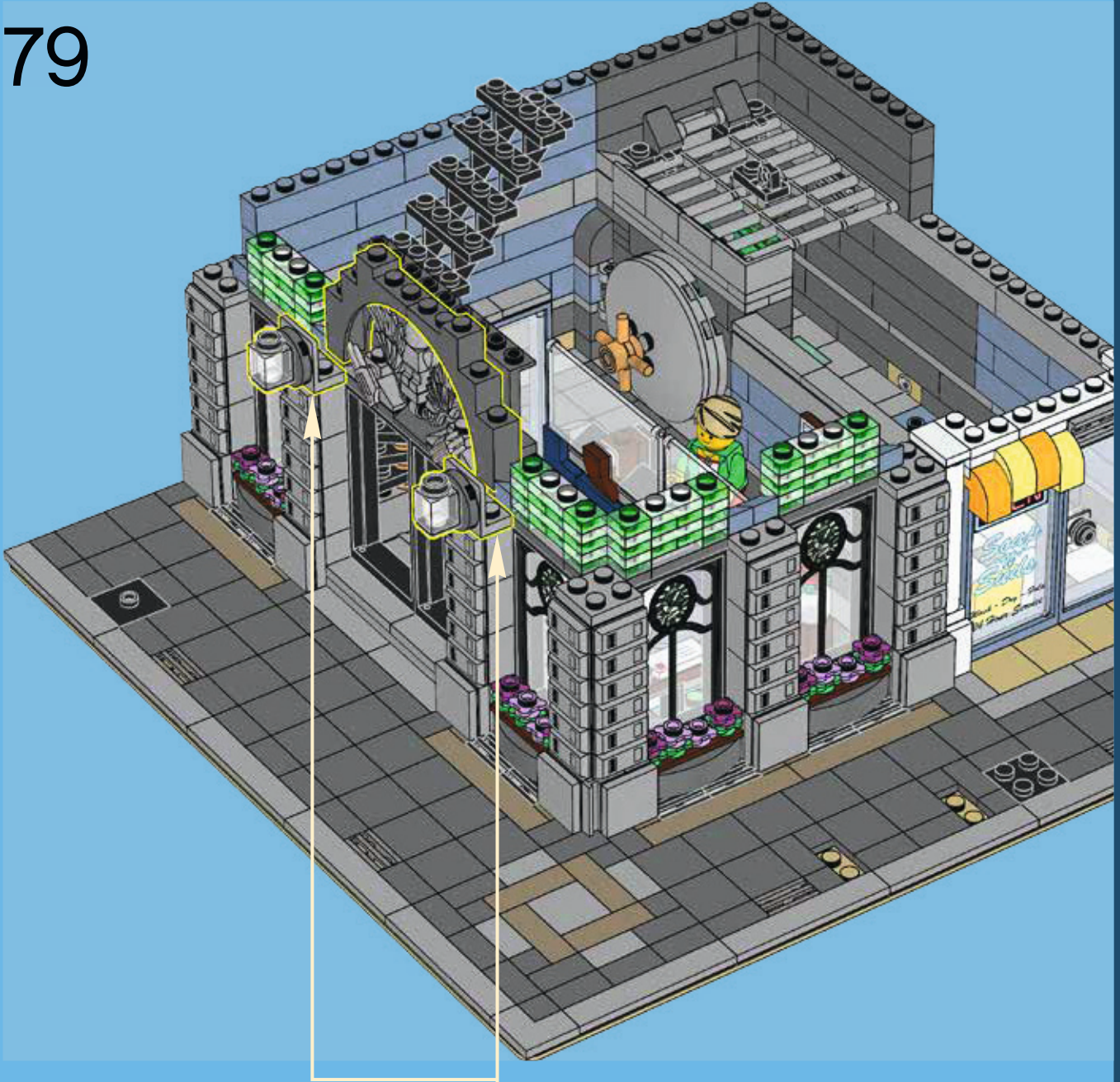

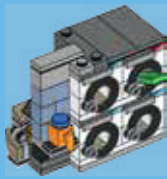

1x



1x

80



1x



1x



1x



1x

81

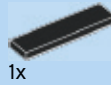
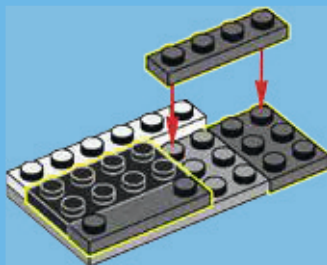

1x



2x



2x



4x

82



2x

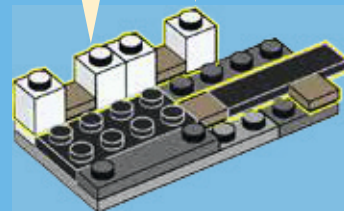

1x



1x



1x



1x

83

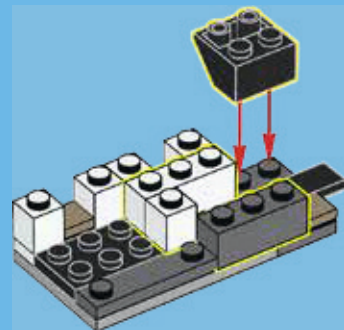

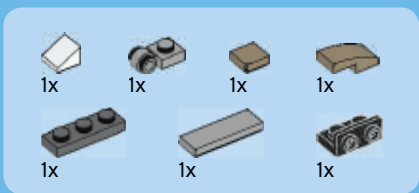

84

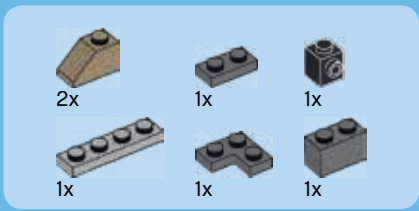
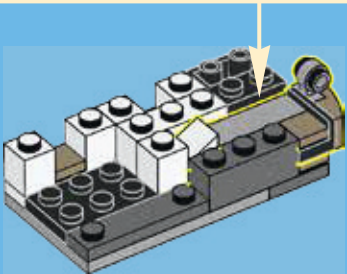
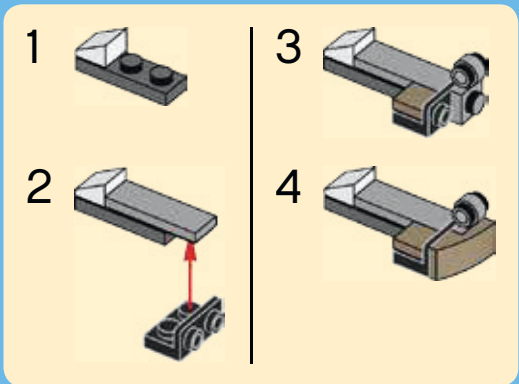

85

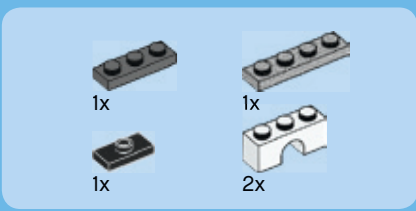
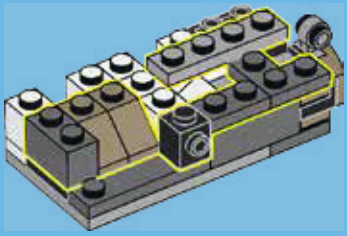

86

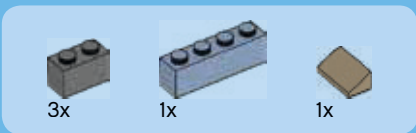
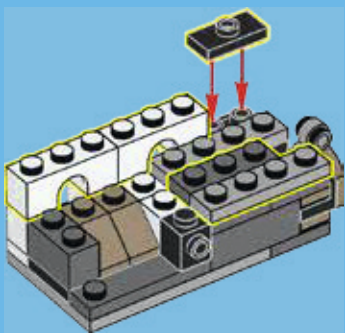

87

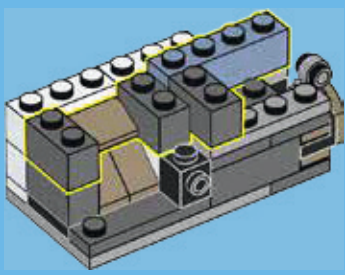



2x



1x



1x



1x

88

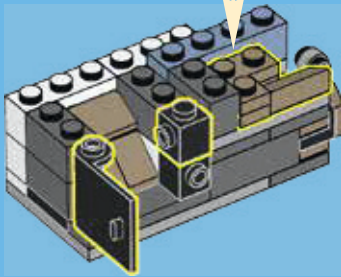
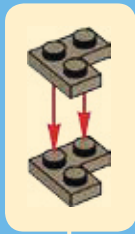

1x



2x



2x



2x



1x

89

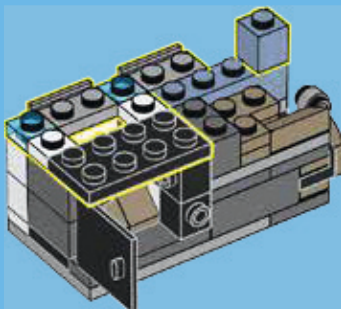

1x



1x



1x



1x



1x

90

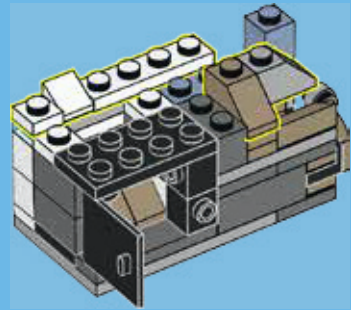

1x



1x



1x

91

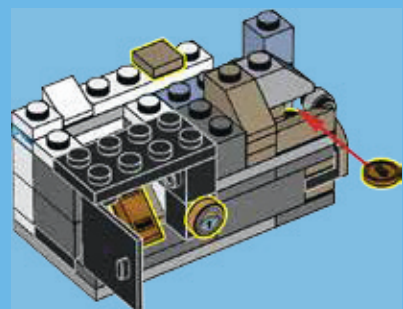



1x



1x



1x



1x



1x



1x

92

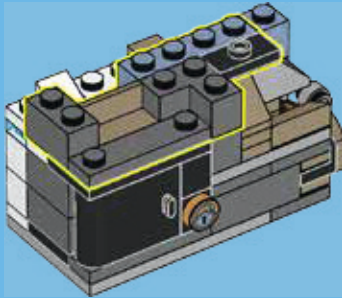

2x



2x



2x

93



2x

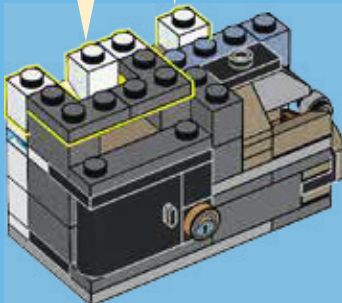

1x



1x



1x



2x

94



2x

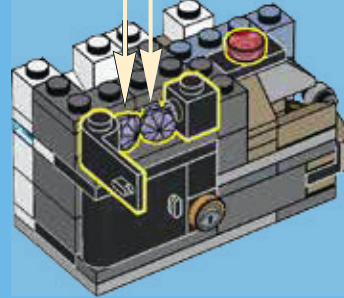

3x



2x



1x

95

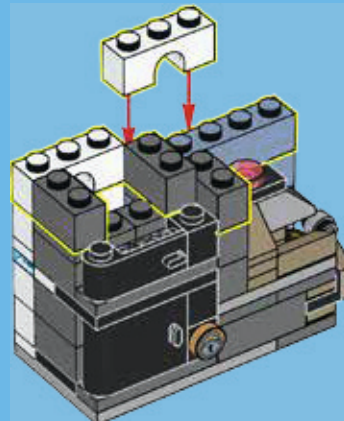

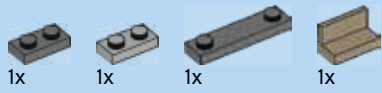

96

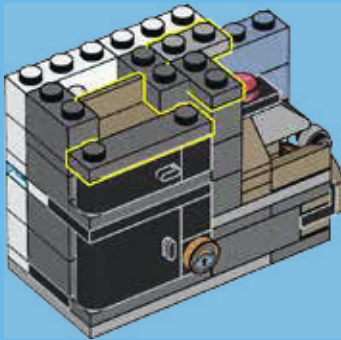

97

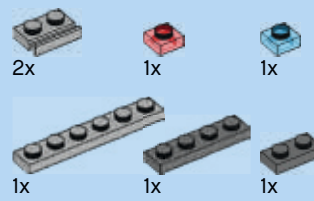
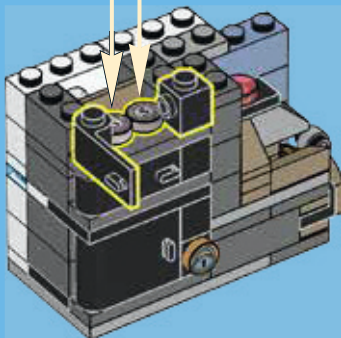
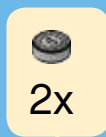

98

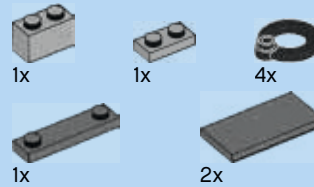
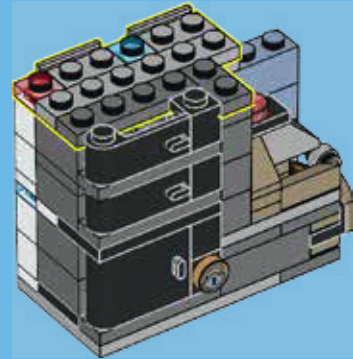

99

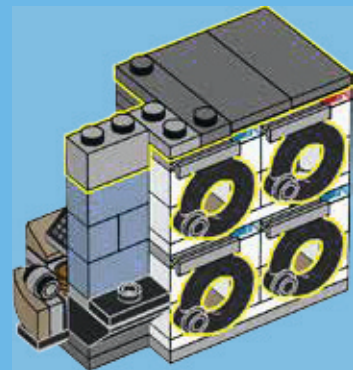



100

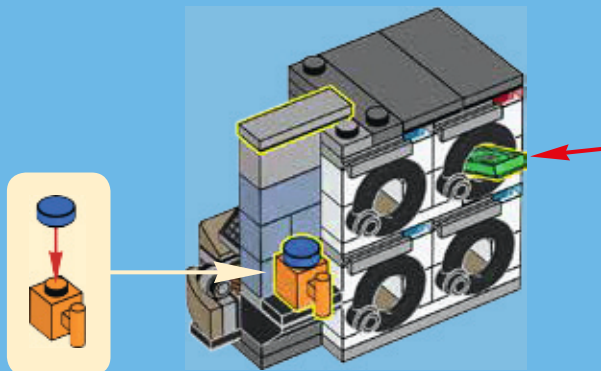

101

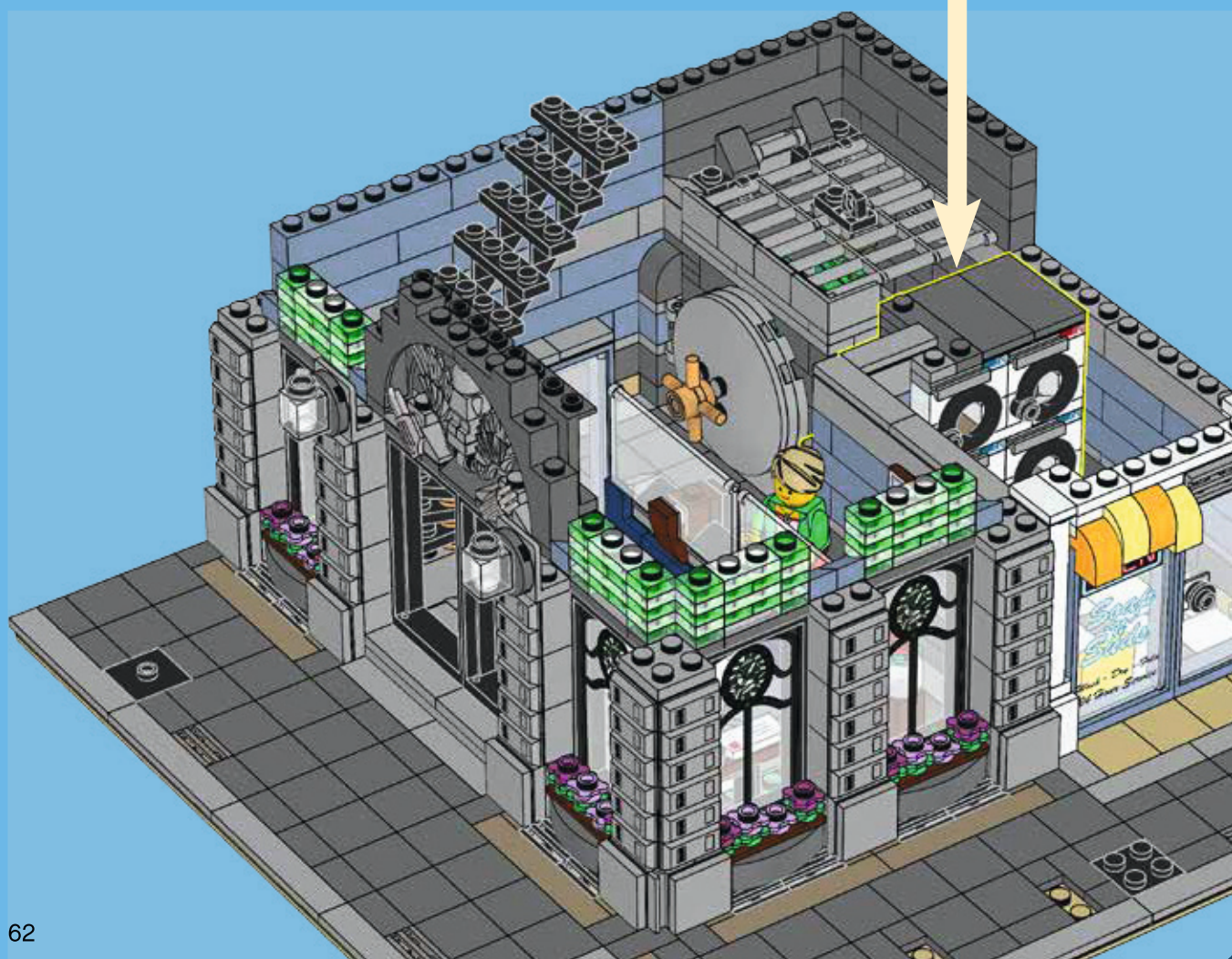

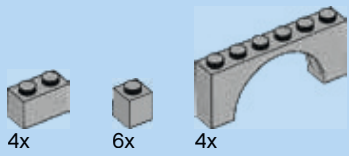

102



3x

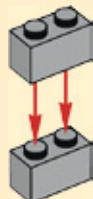
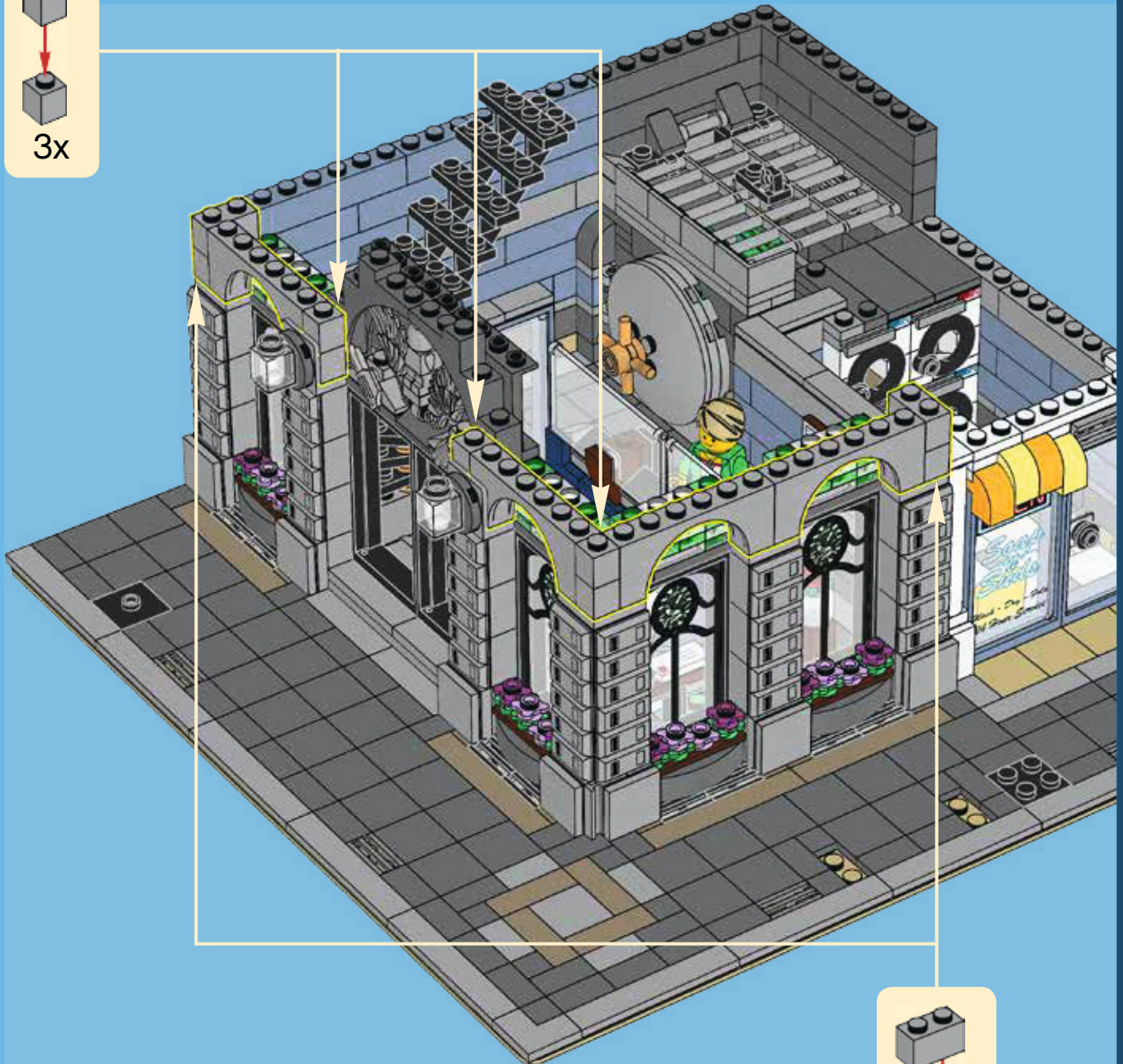

2x

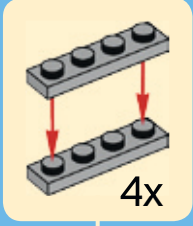
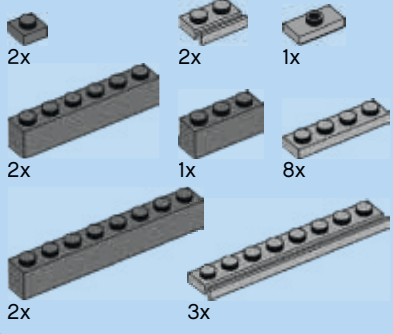

103

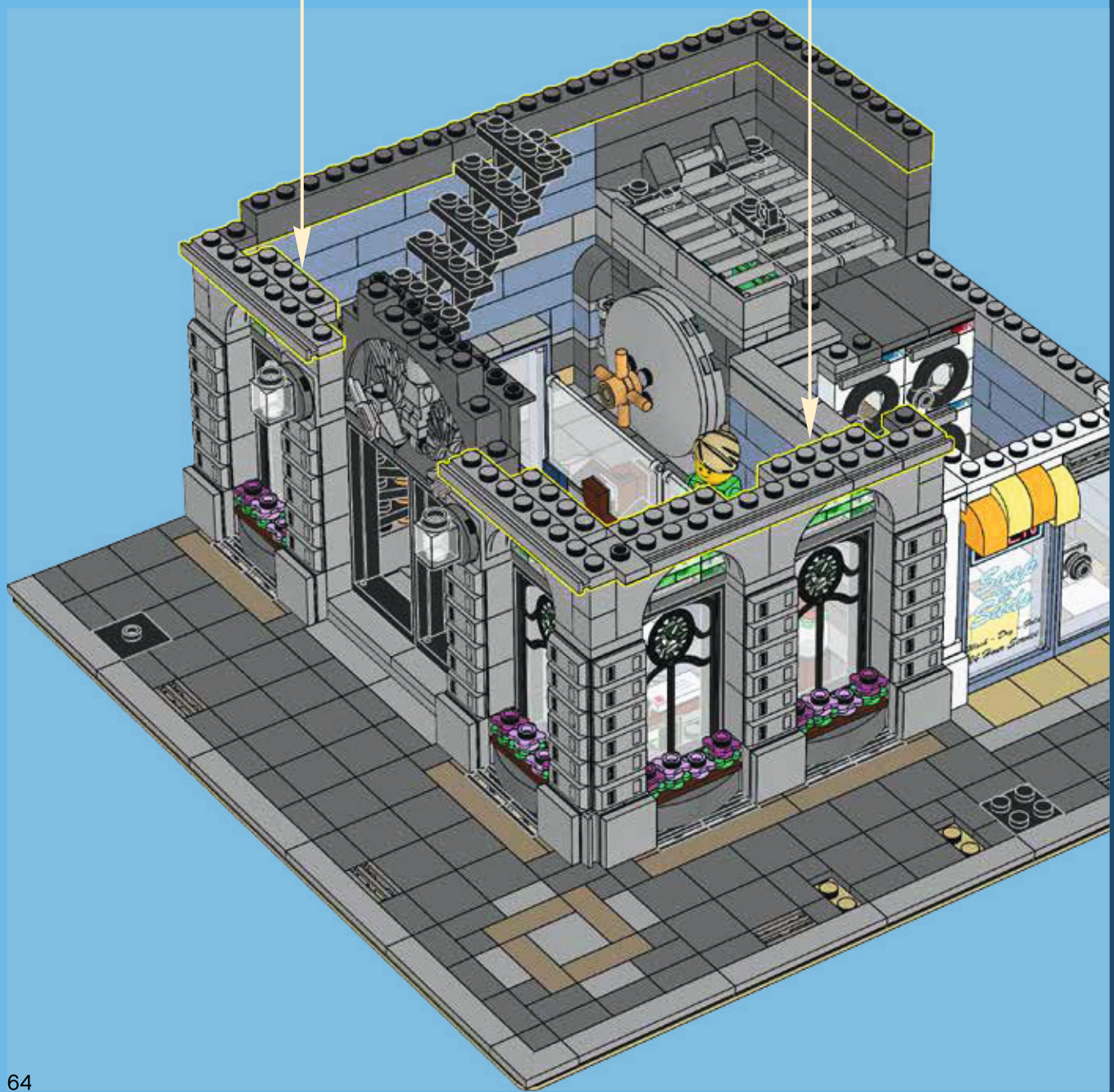

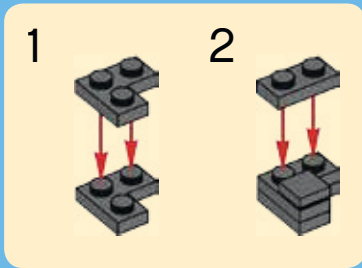
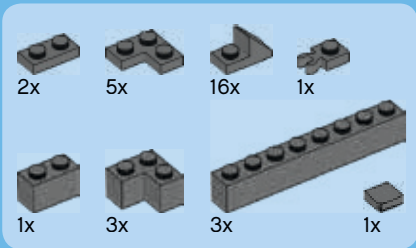

104

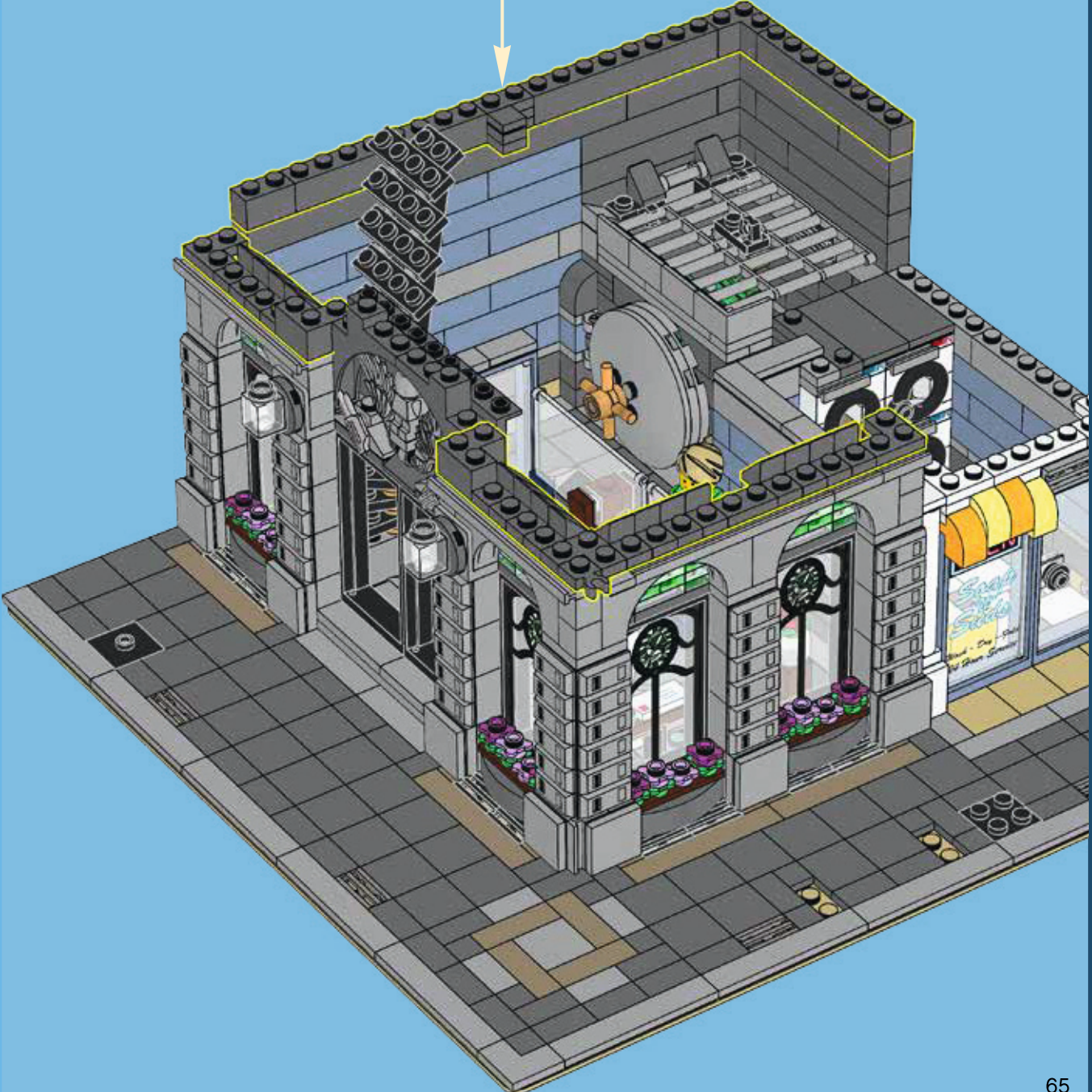

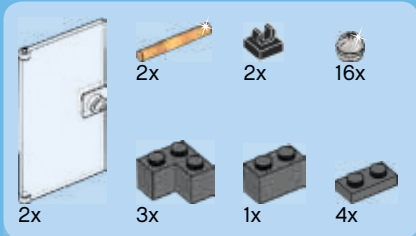

105

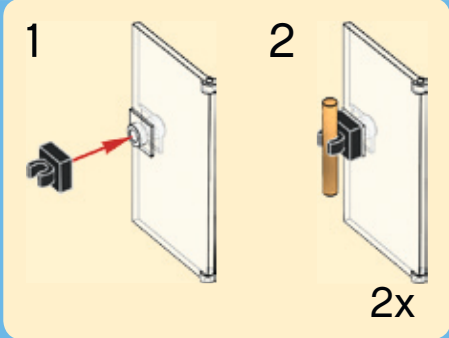
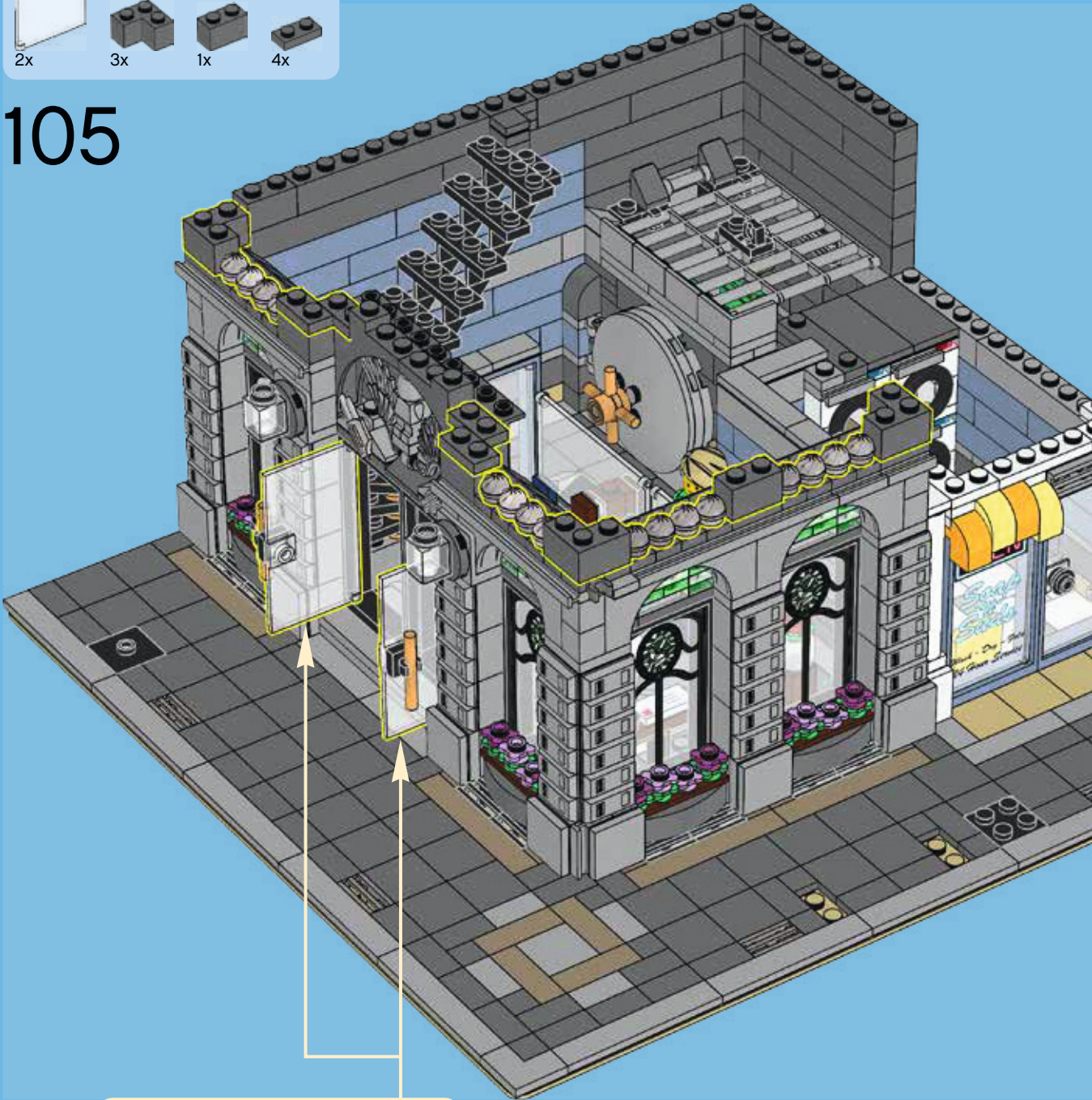

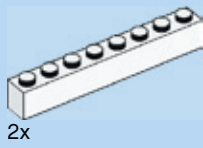

106

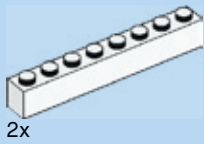
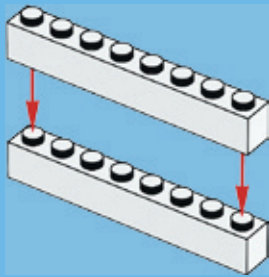

107

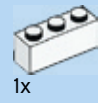
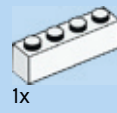
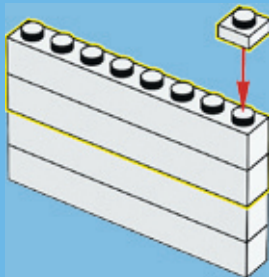

108

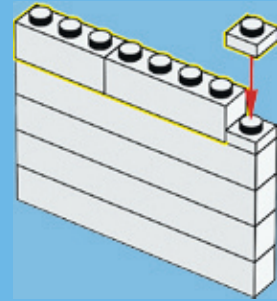

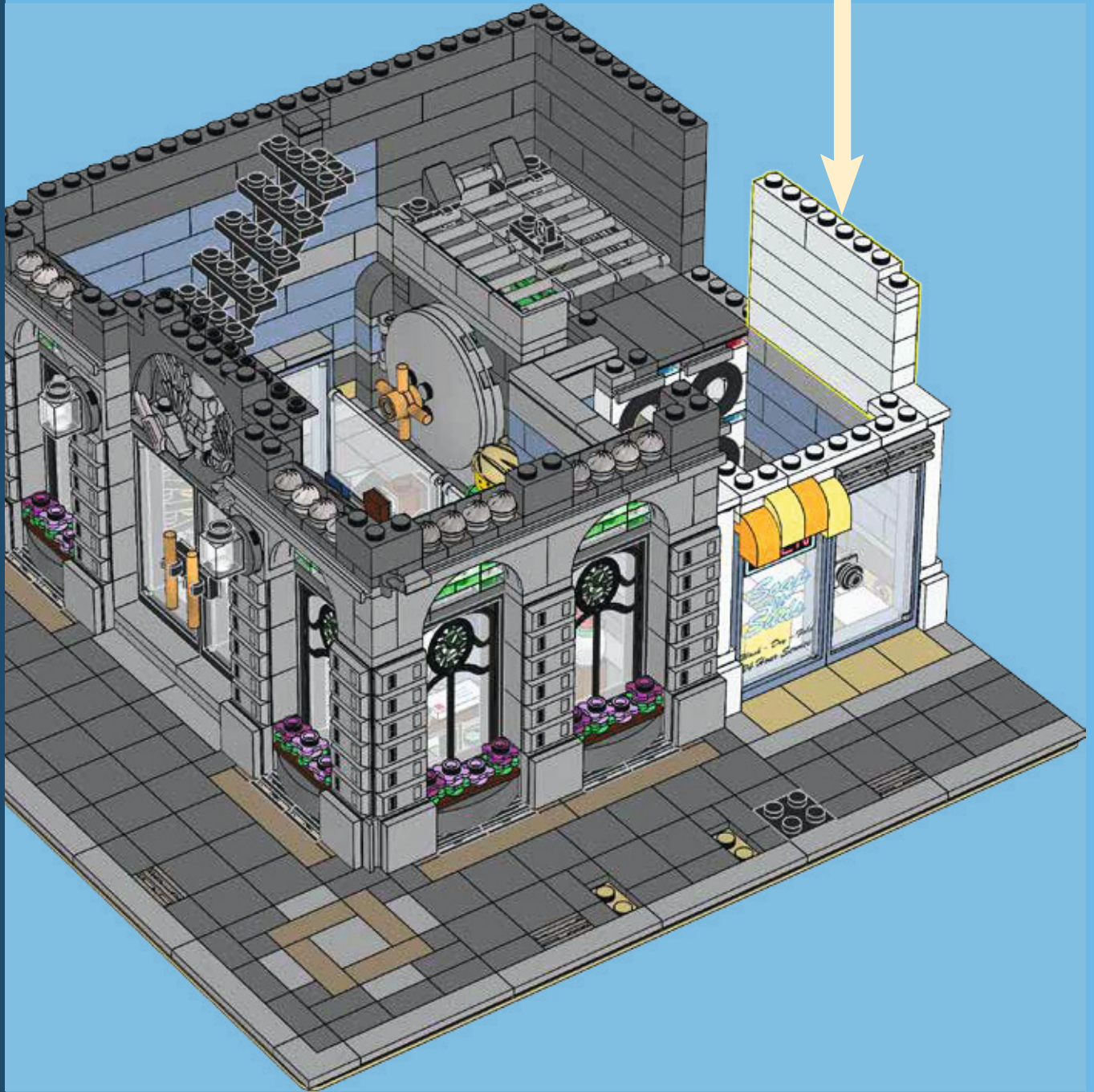



1x



1x

110

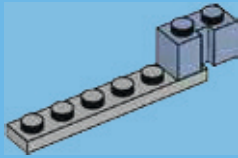

1x



1x



2x



2x

111

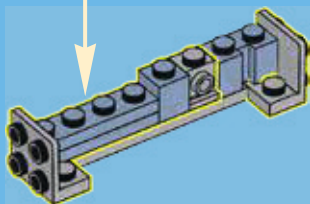
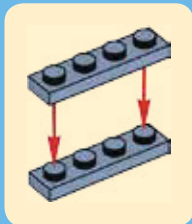

1x

1x

1x

1x

2x

112

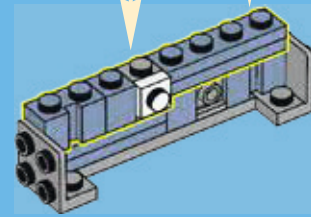
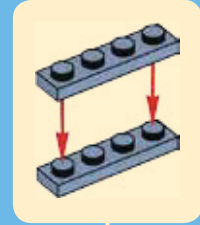
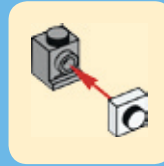

2x



2x

113

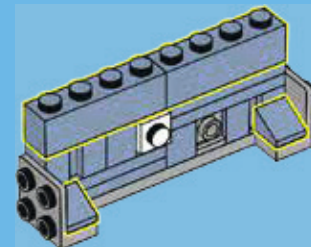



1x



2x

114

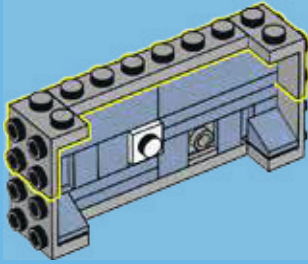

2x



2x

115

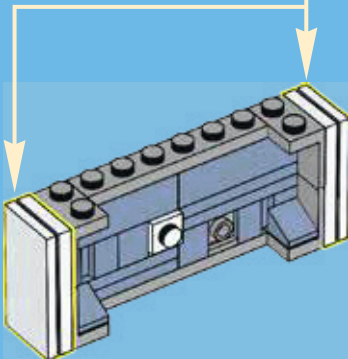
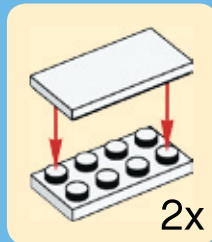

1x



1x



1x



2x



1x



1x



1x

116

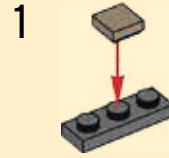

1

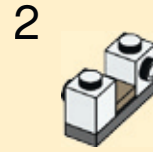

2

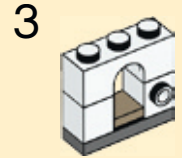

3

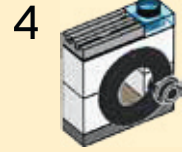

4

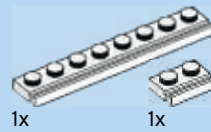
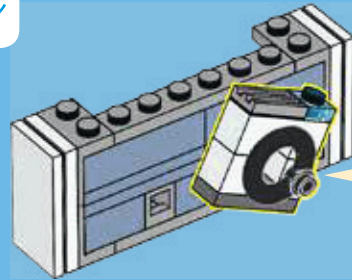

1x



1x



1x



1x

117

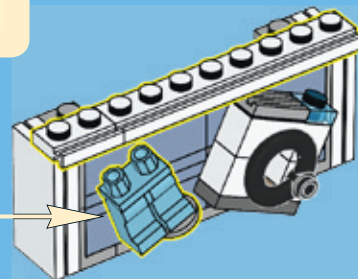
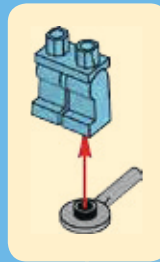

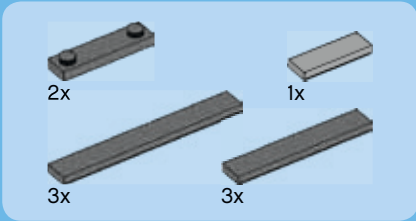

121

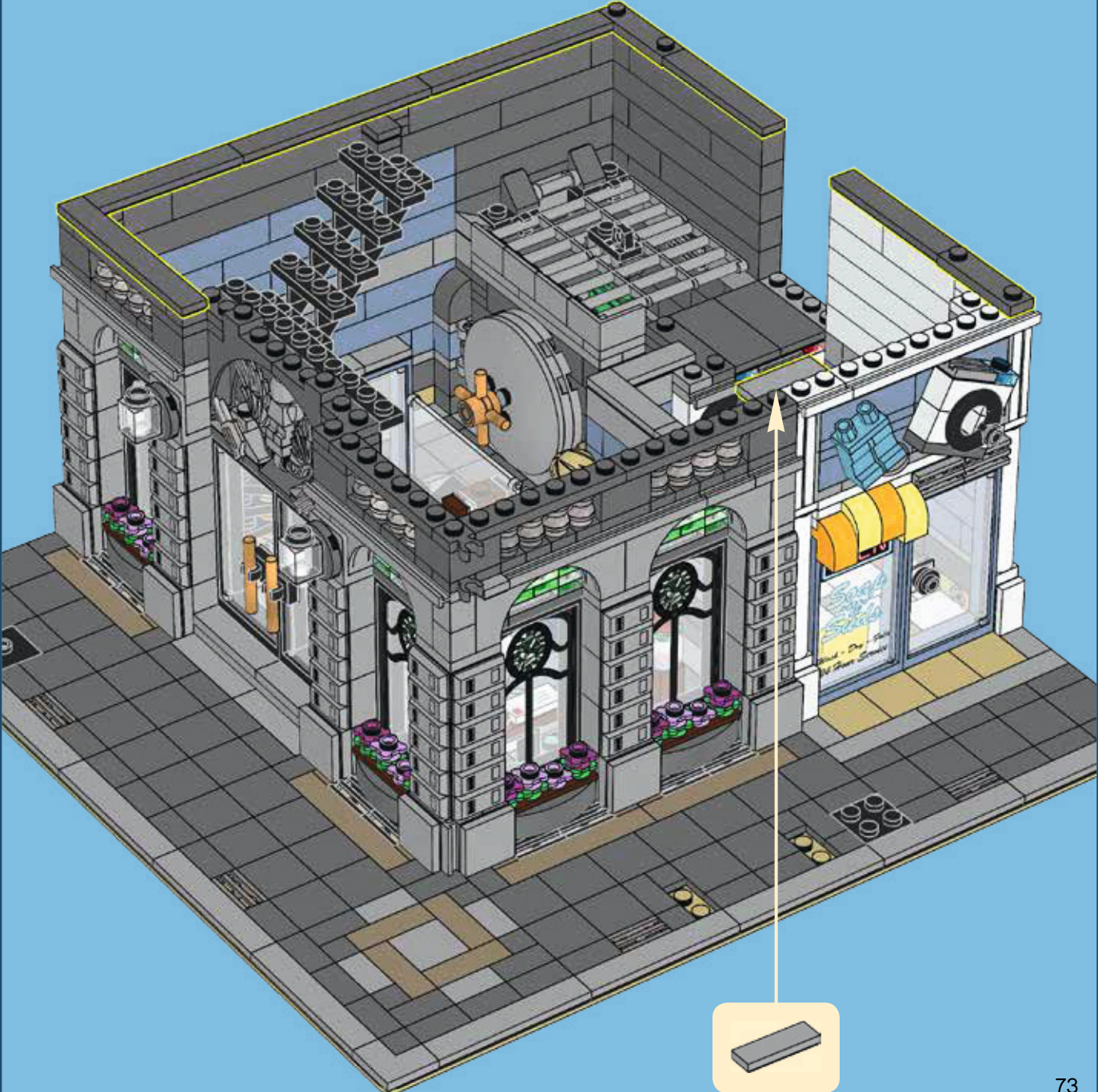

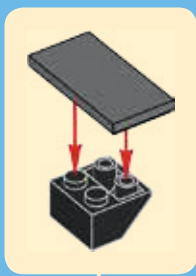
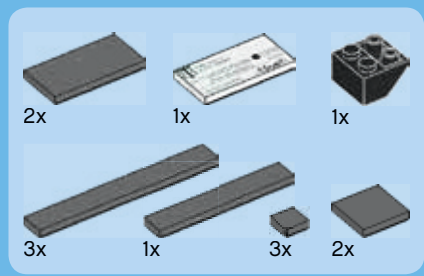

122

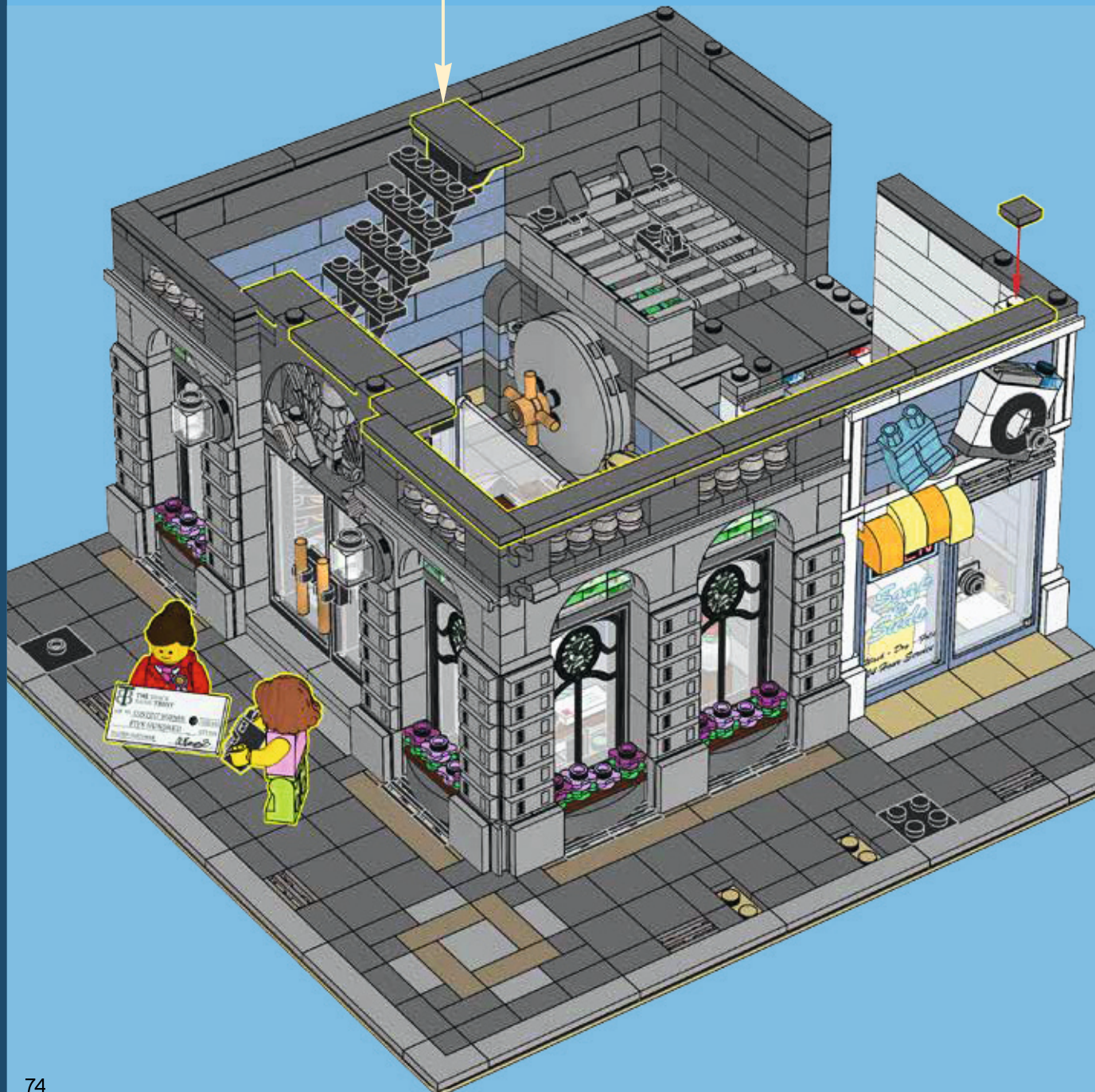

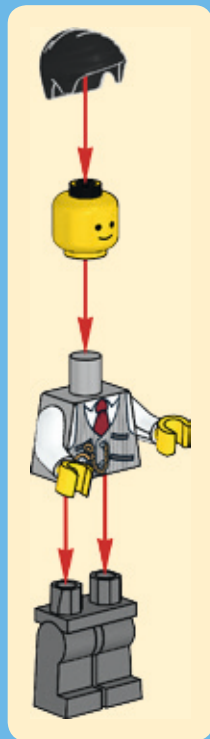
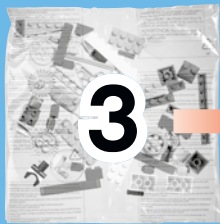



1x



1x

123



2x



2x

124

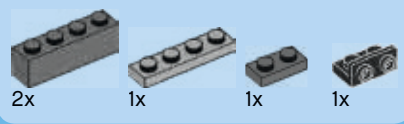

125

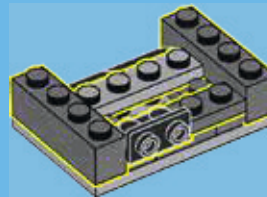

2x

126

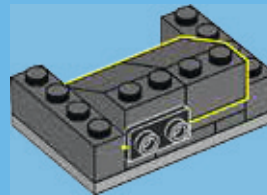



2x



1x

127

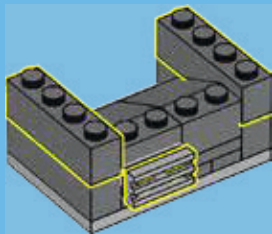

2x

128

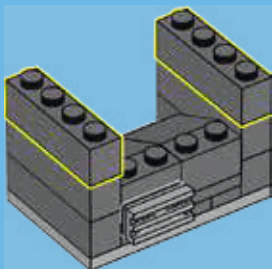

2x



6x

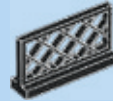

1x



2x



2x

129

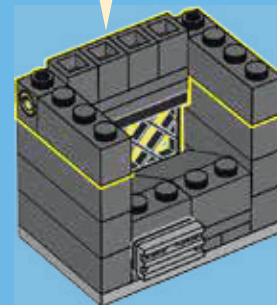
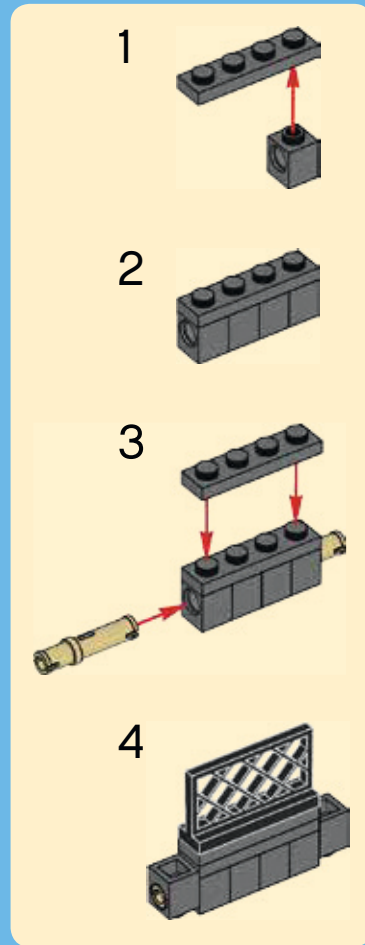



2x

130

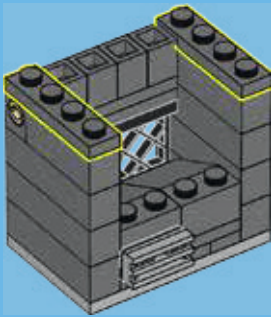

2x



4x

132

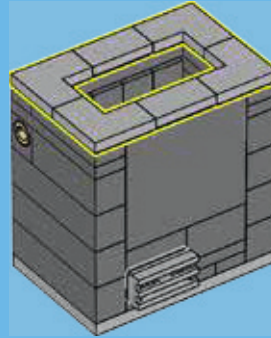

1x



2x



1x

131

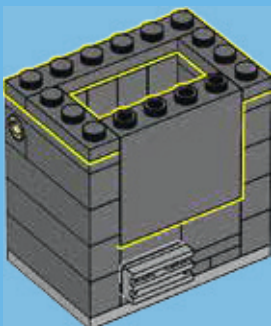

133

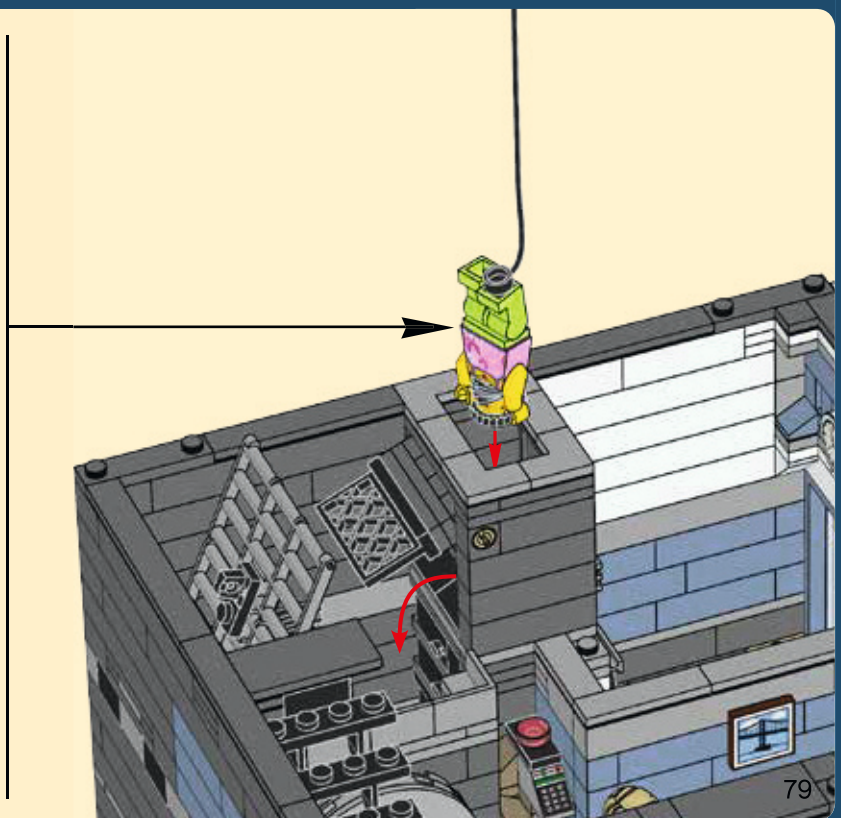
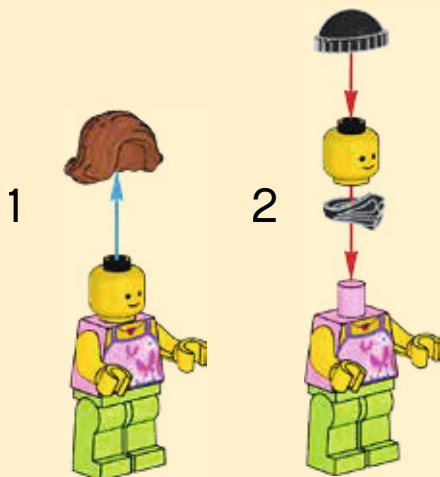
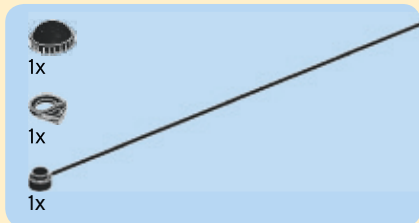
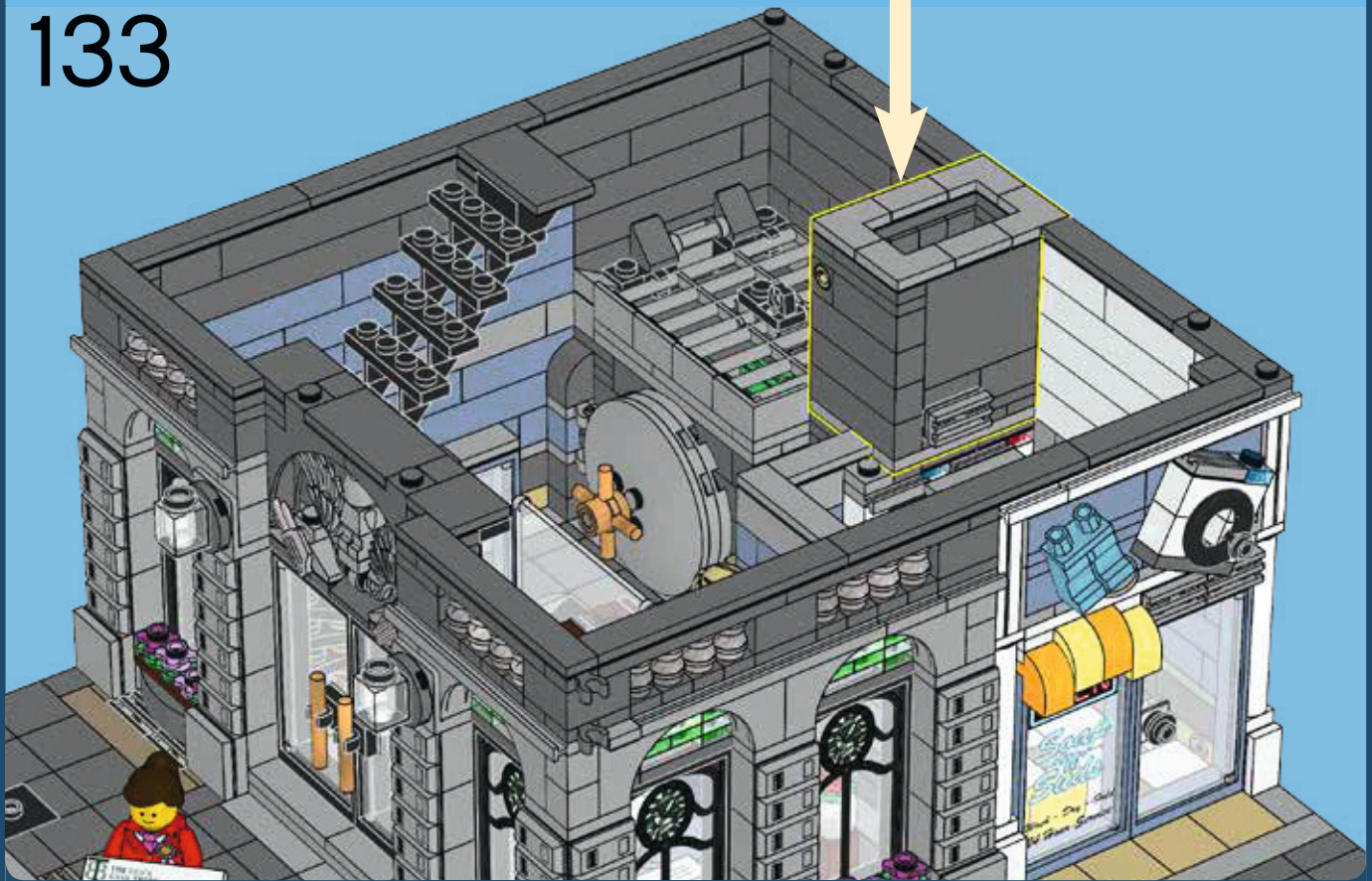

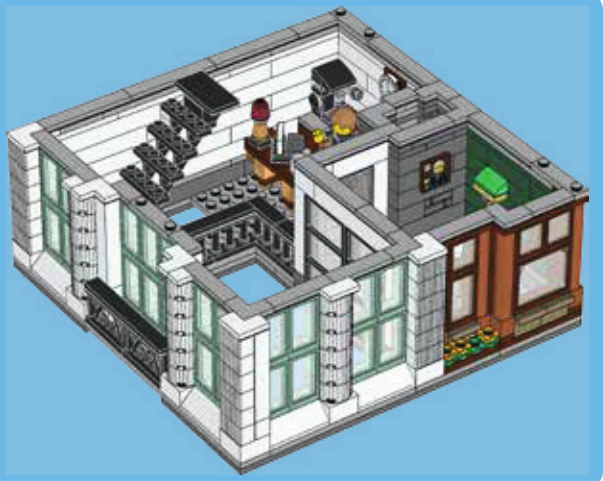

1x



1x

134

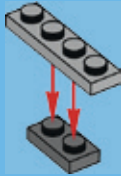

2x

135

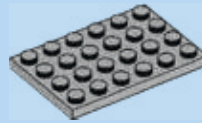
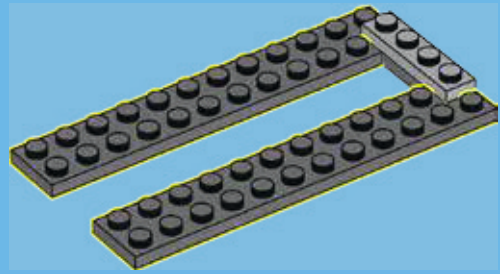

1x



3x

136

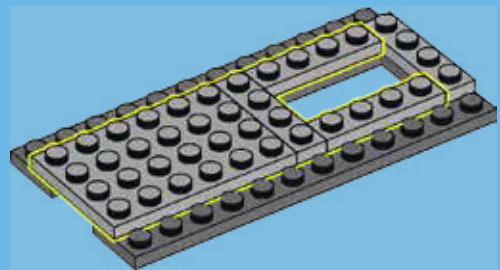



4x

137

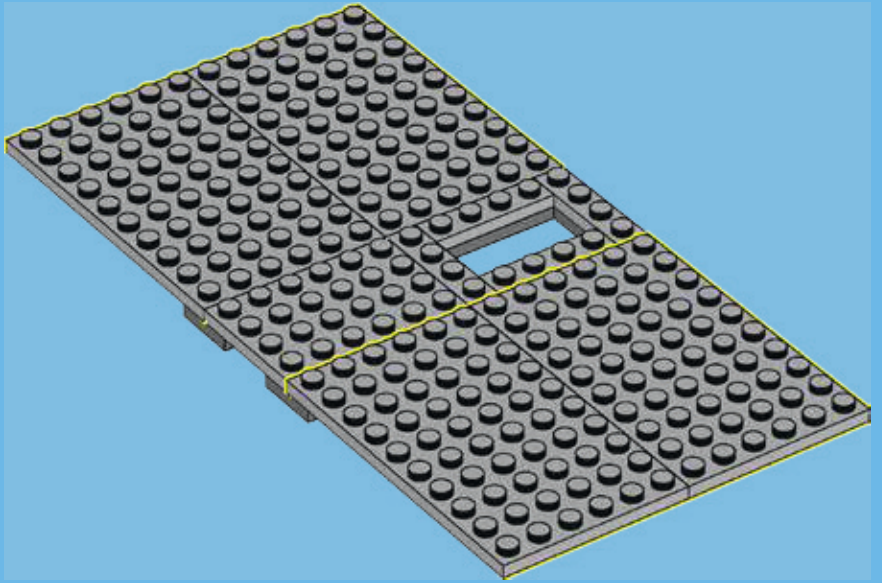

2x



1x



2x



4x

138

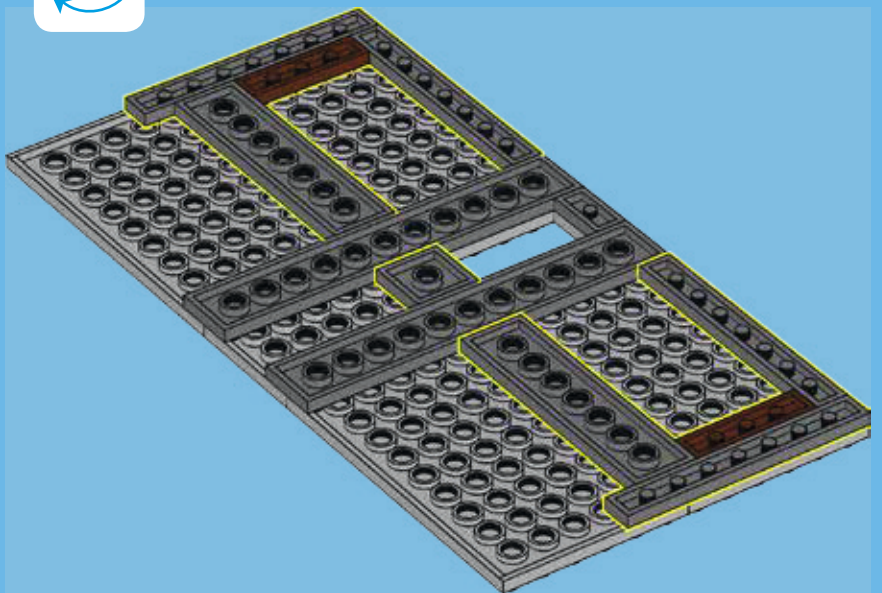

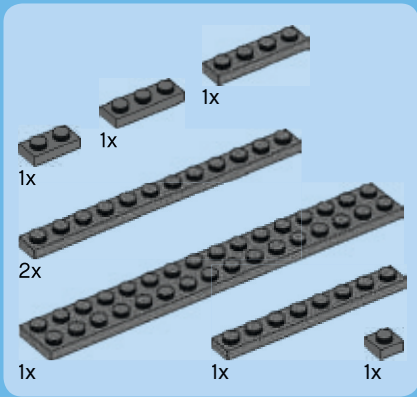

139

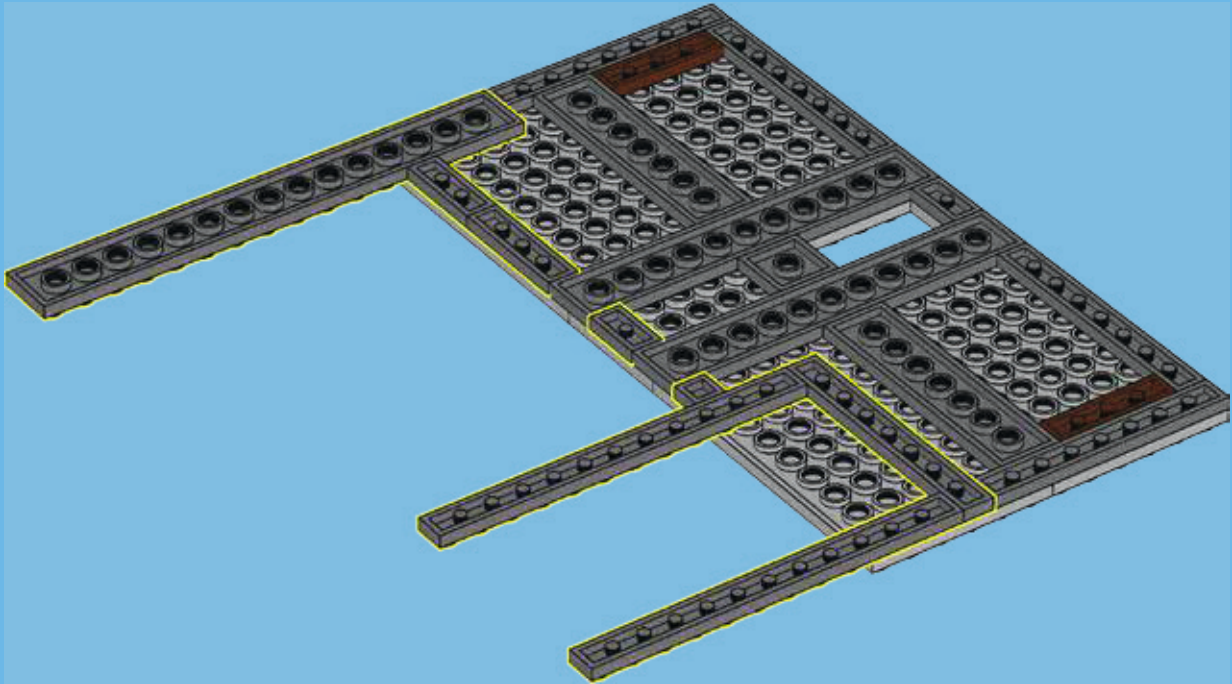

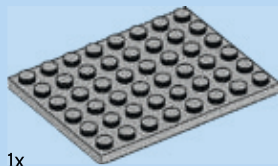

1x



1x

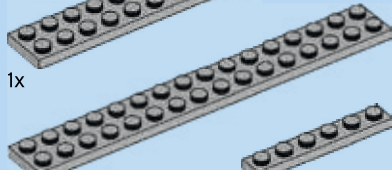

1x



2x

140

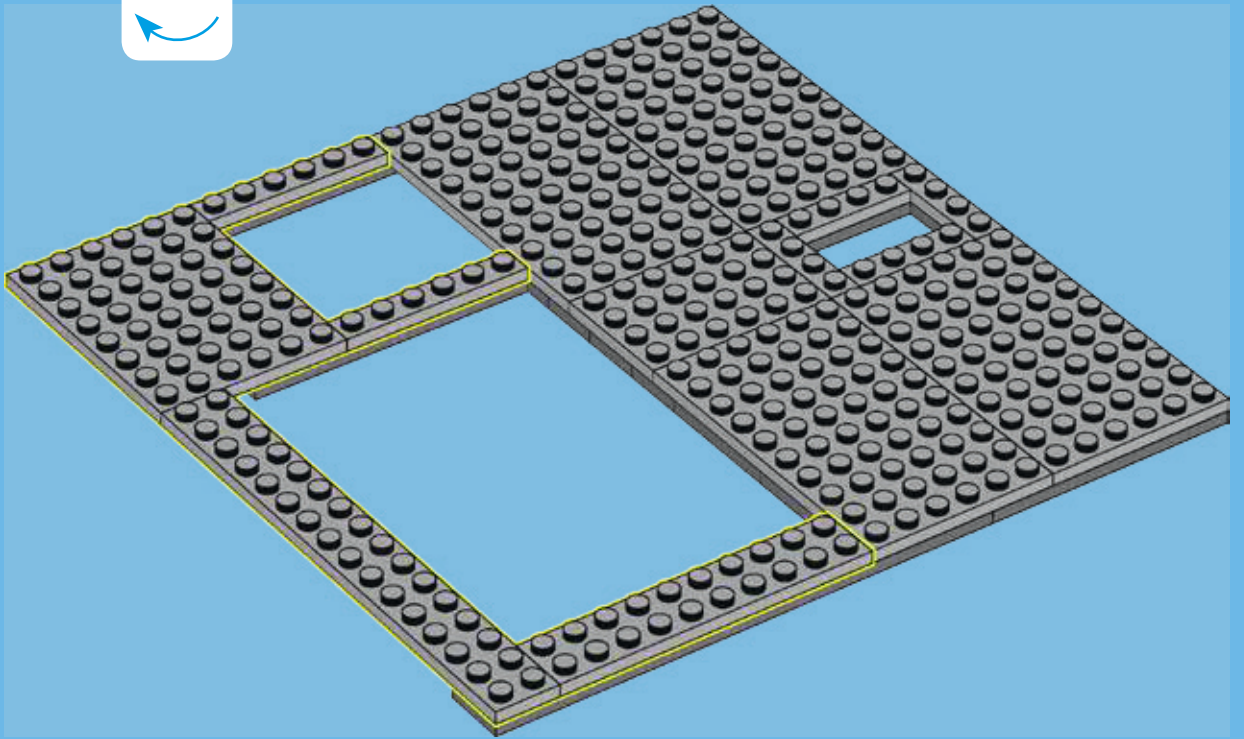

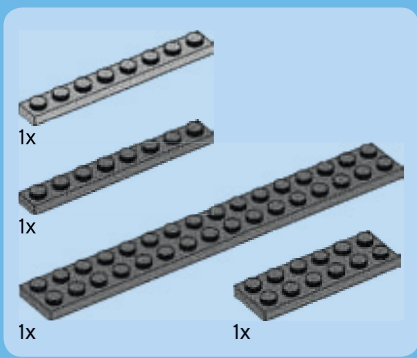

141

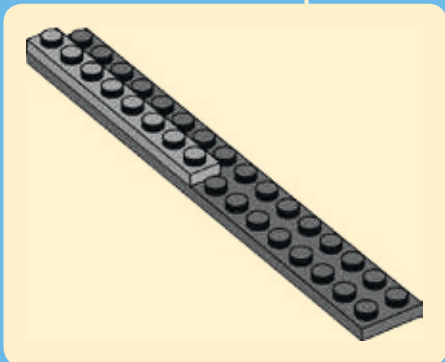
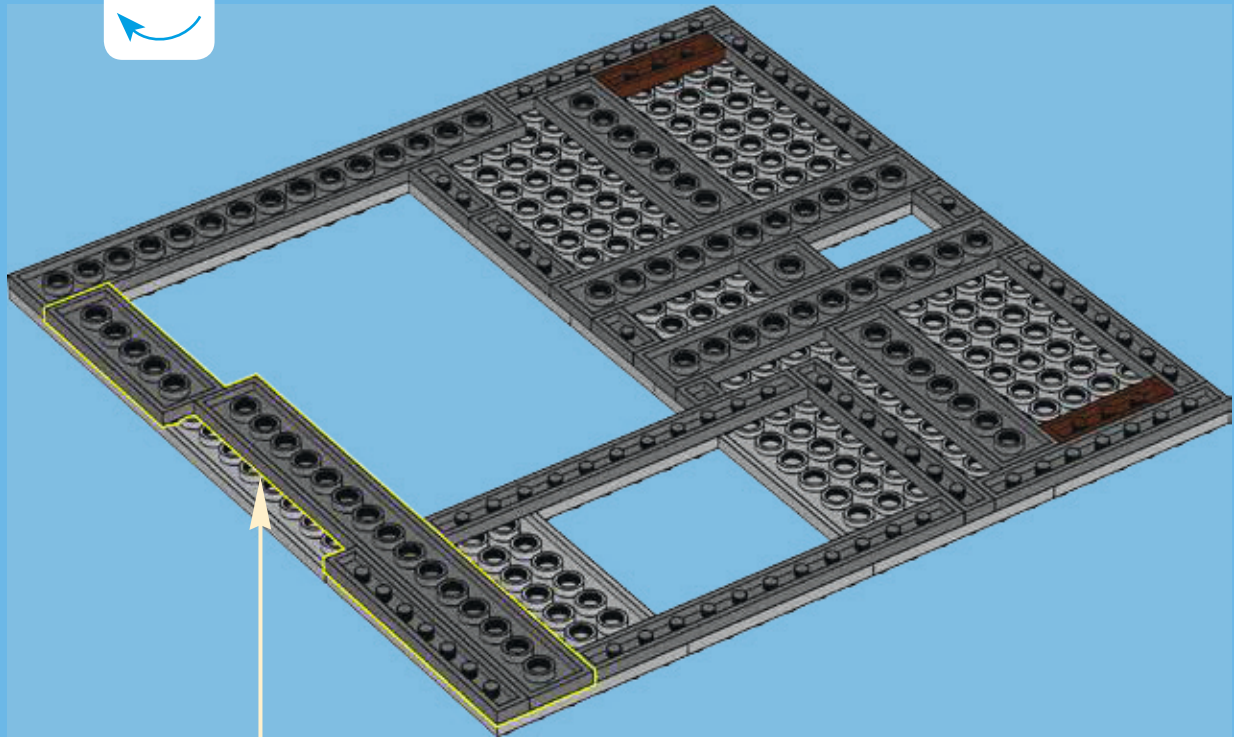

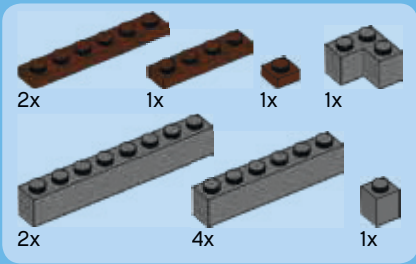

142

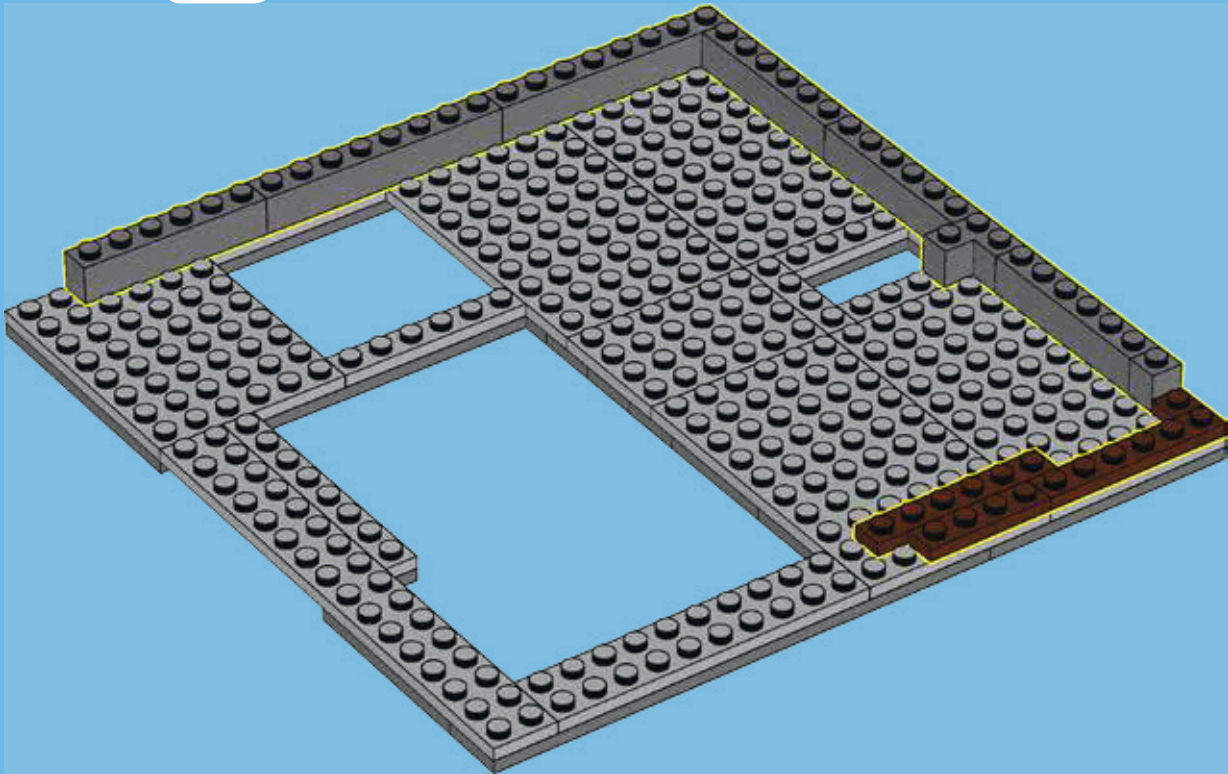

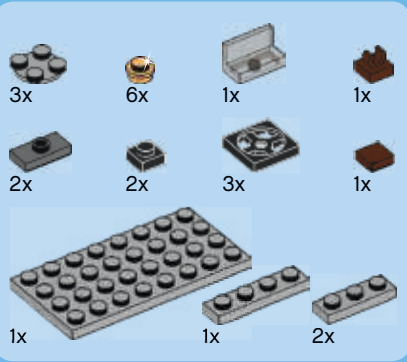

143

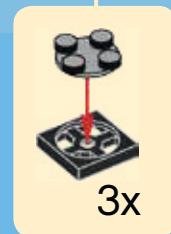
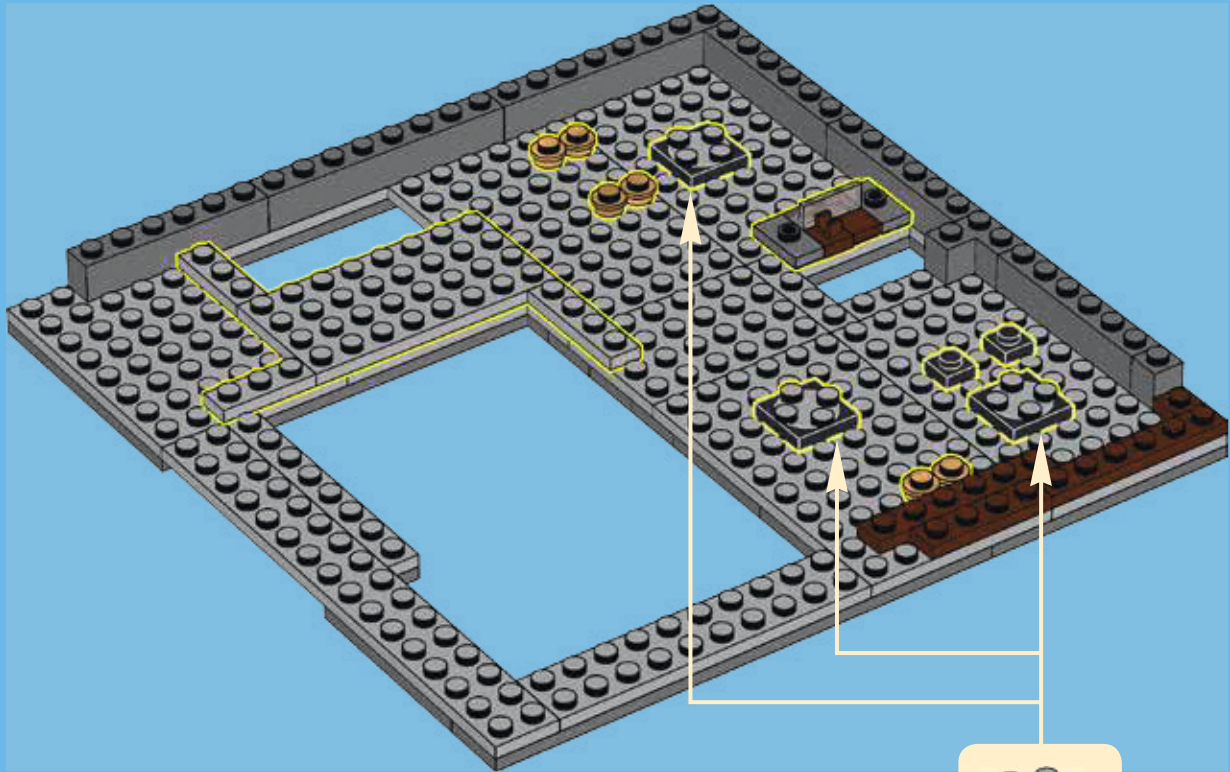



144

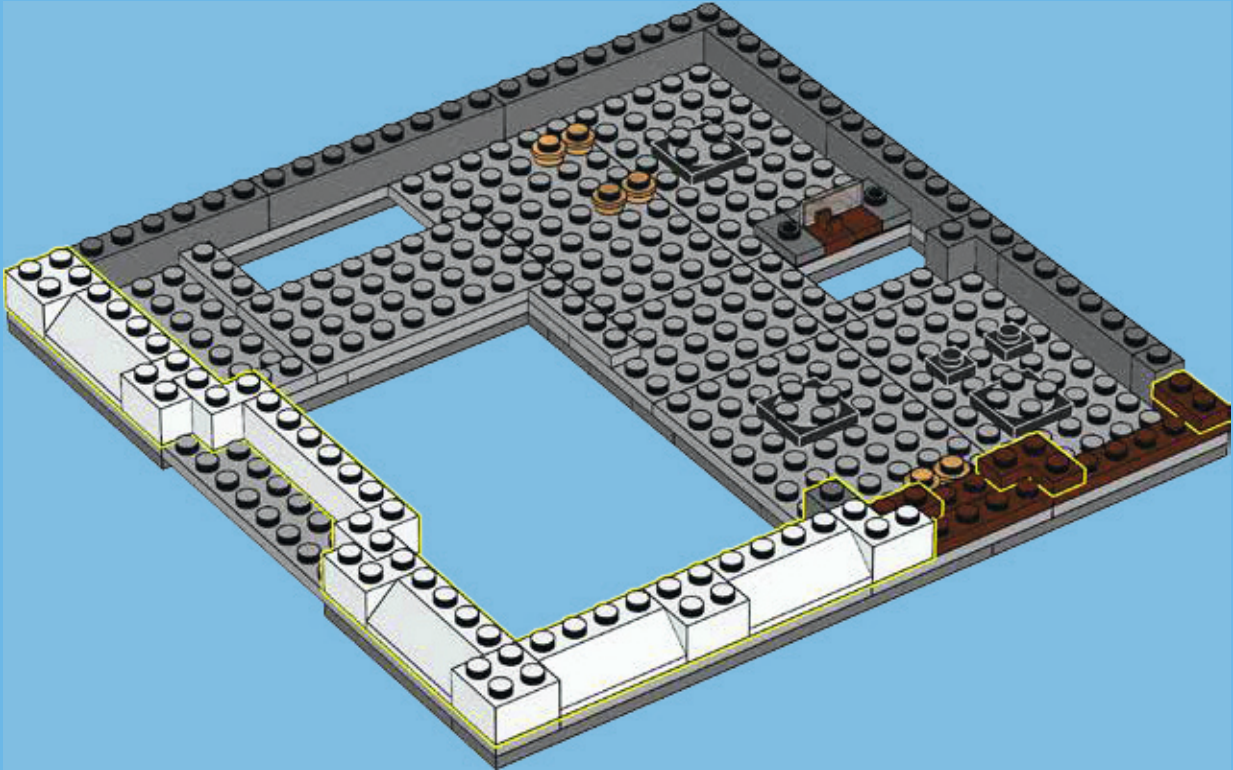

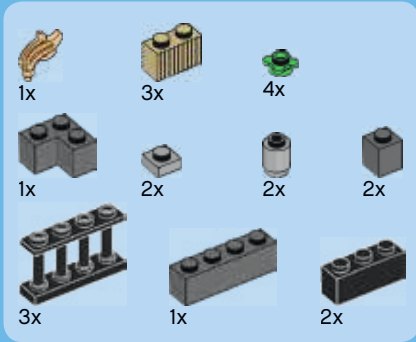

145

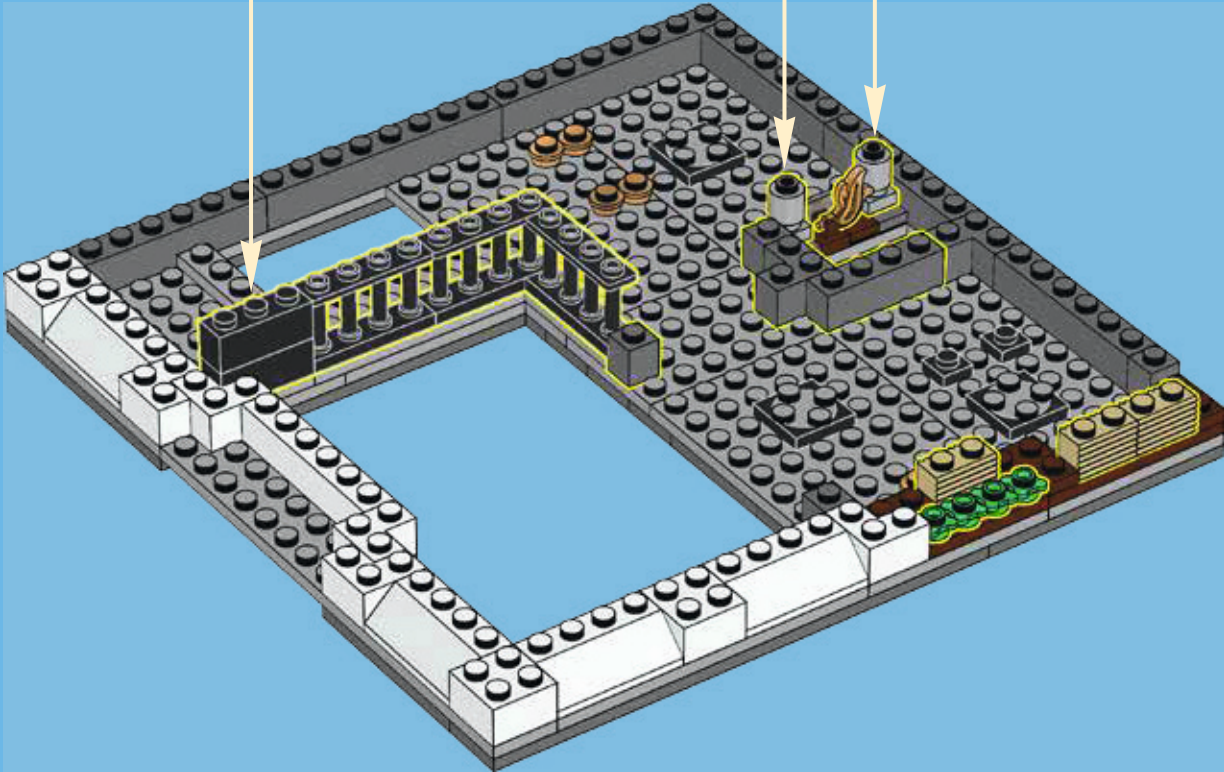
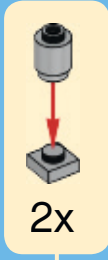
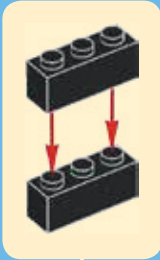

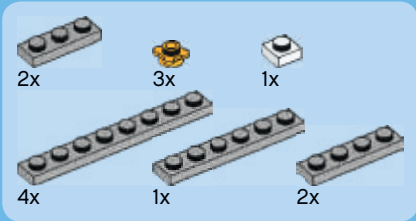

146

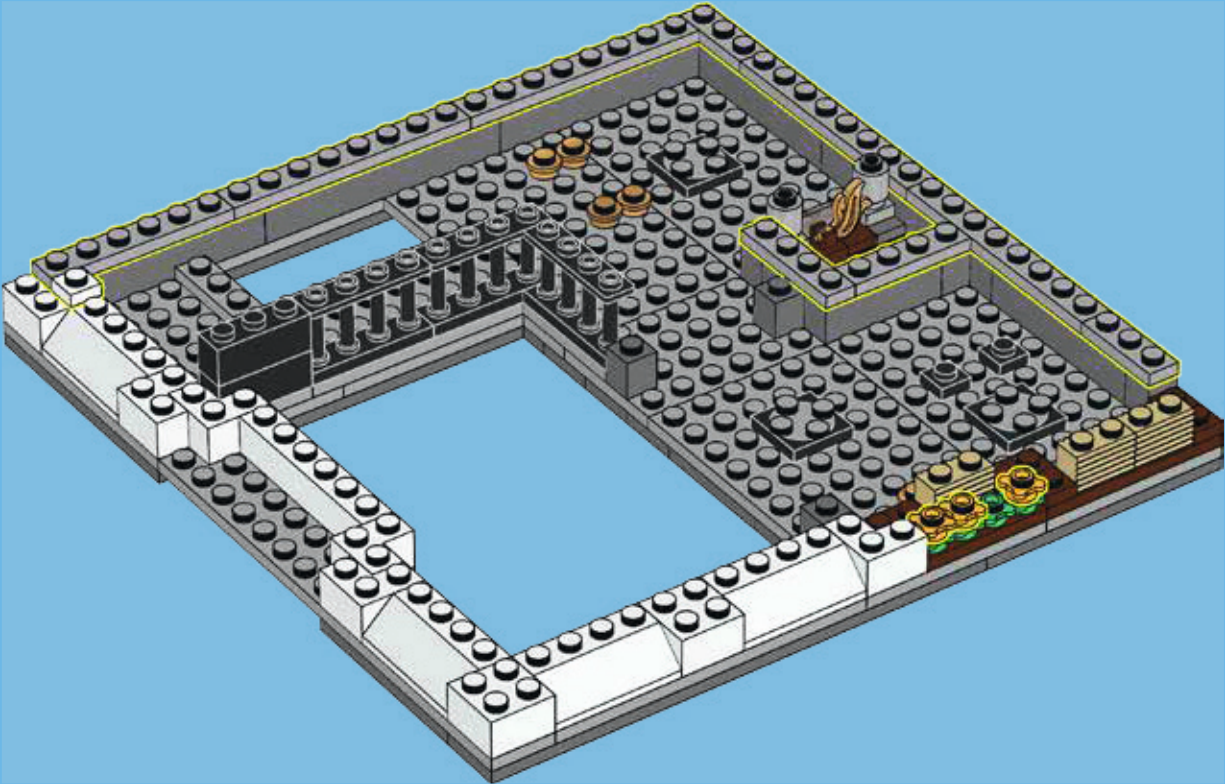

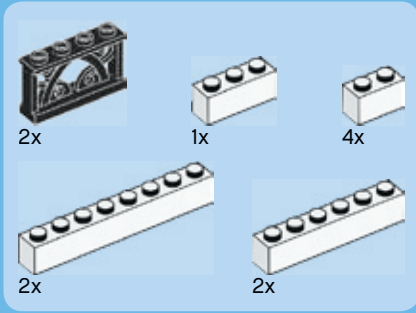

147

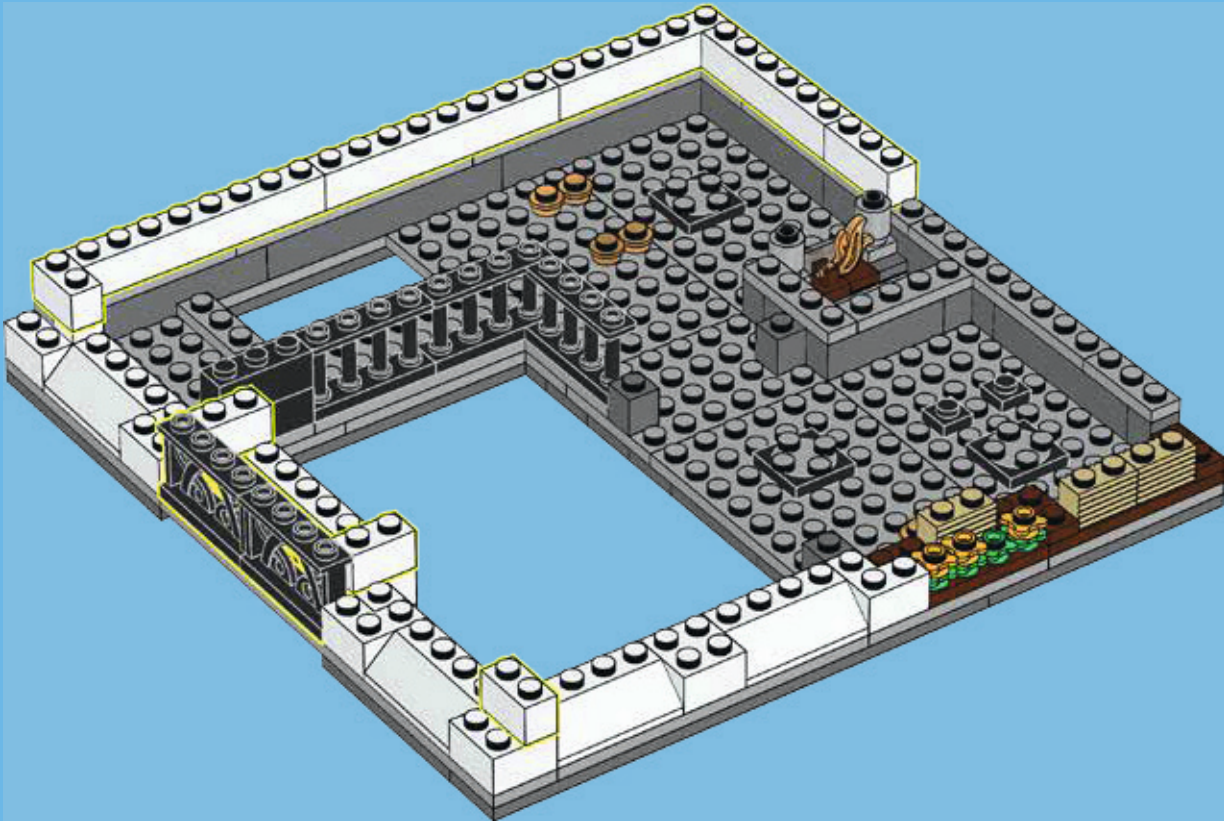

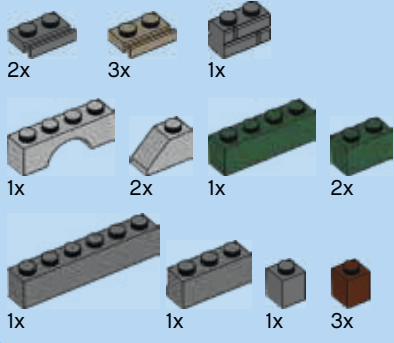

148

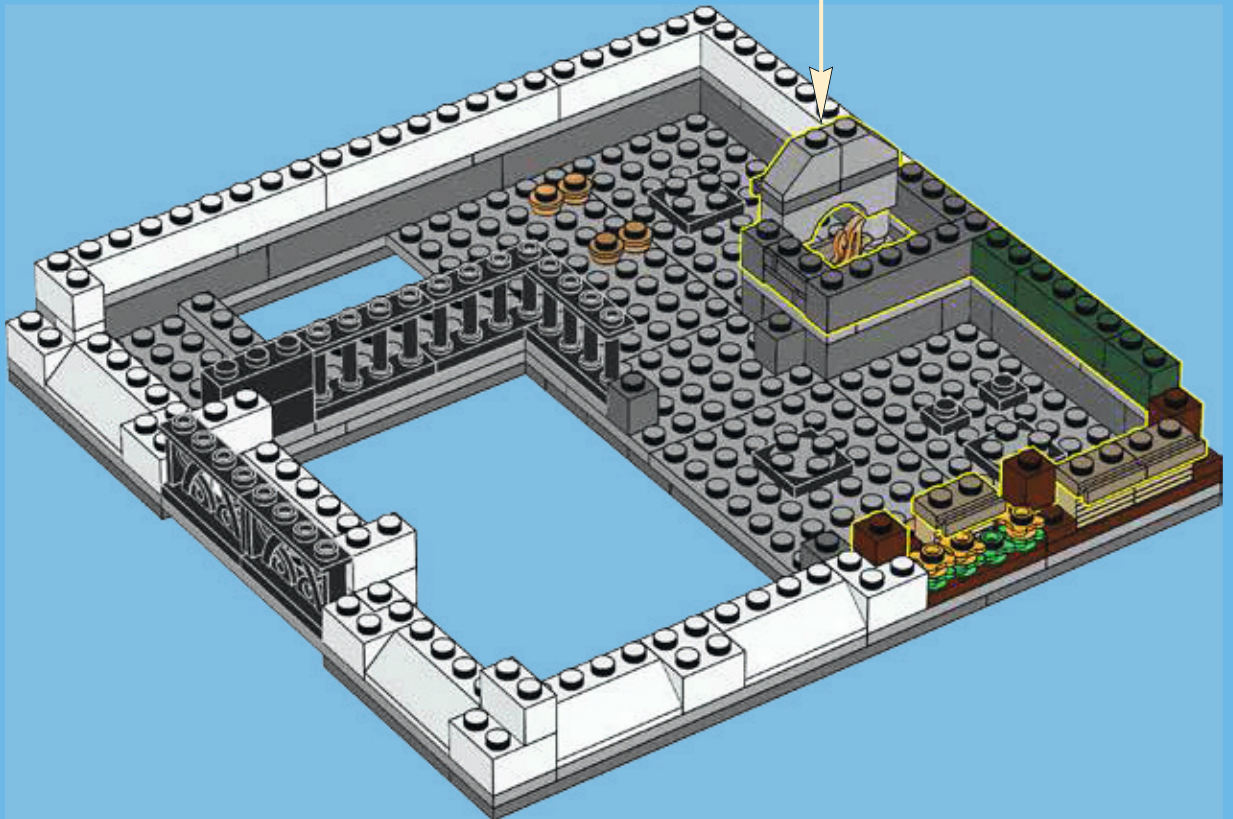
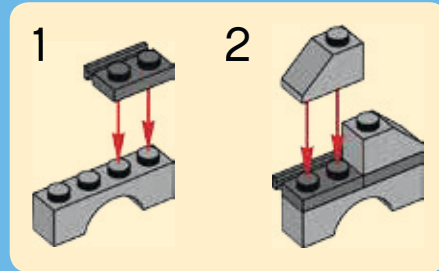

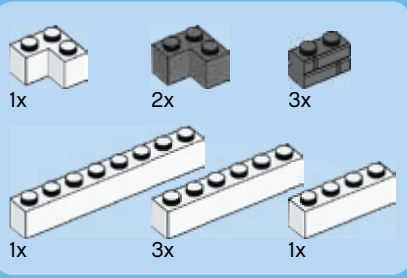

149

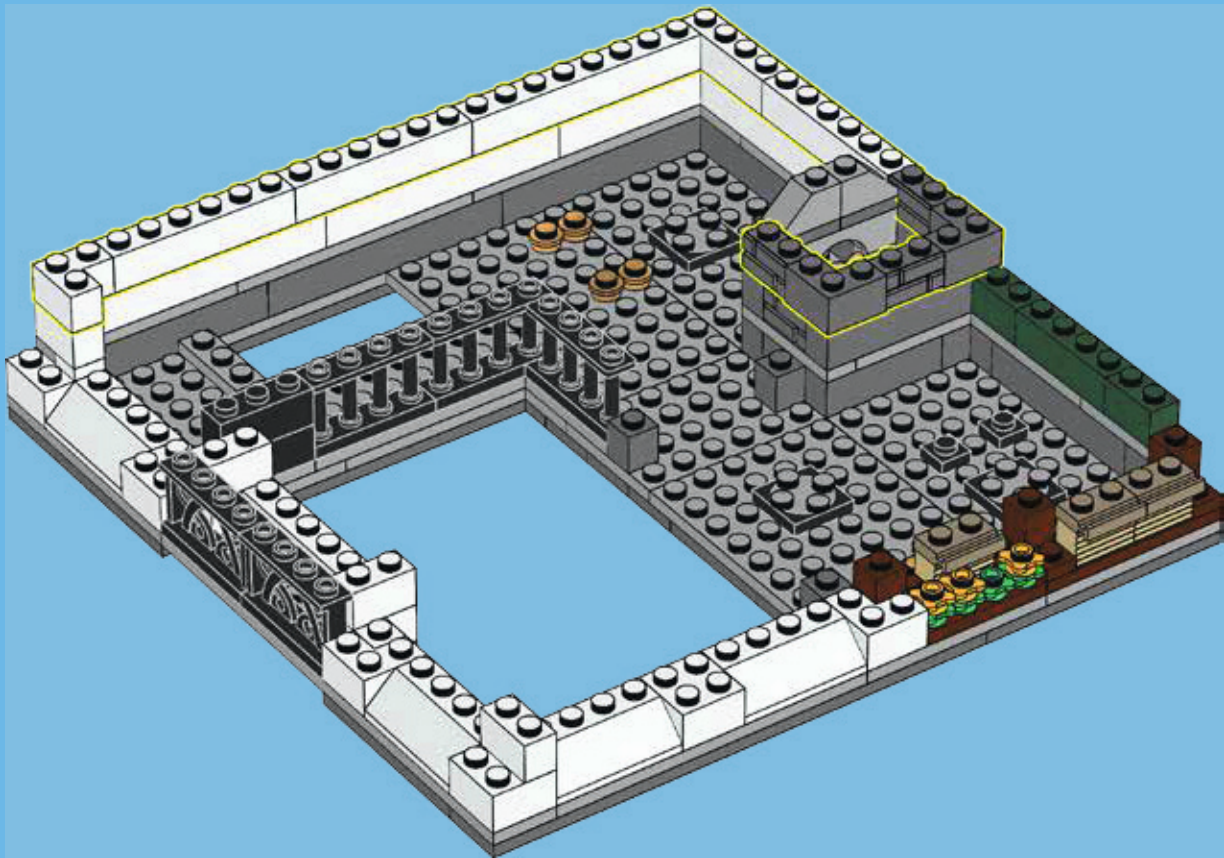

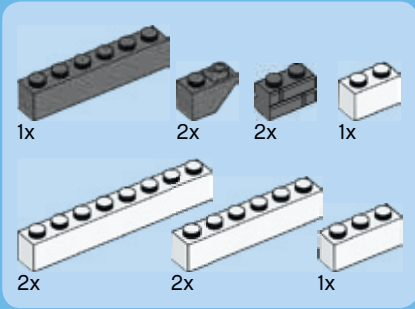

150

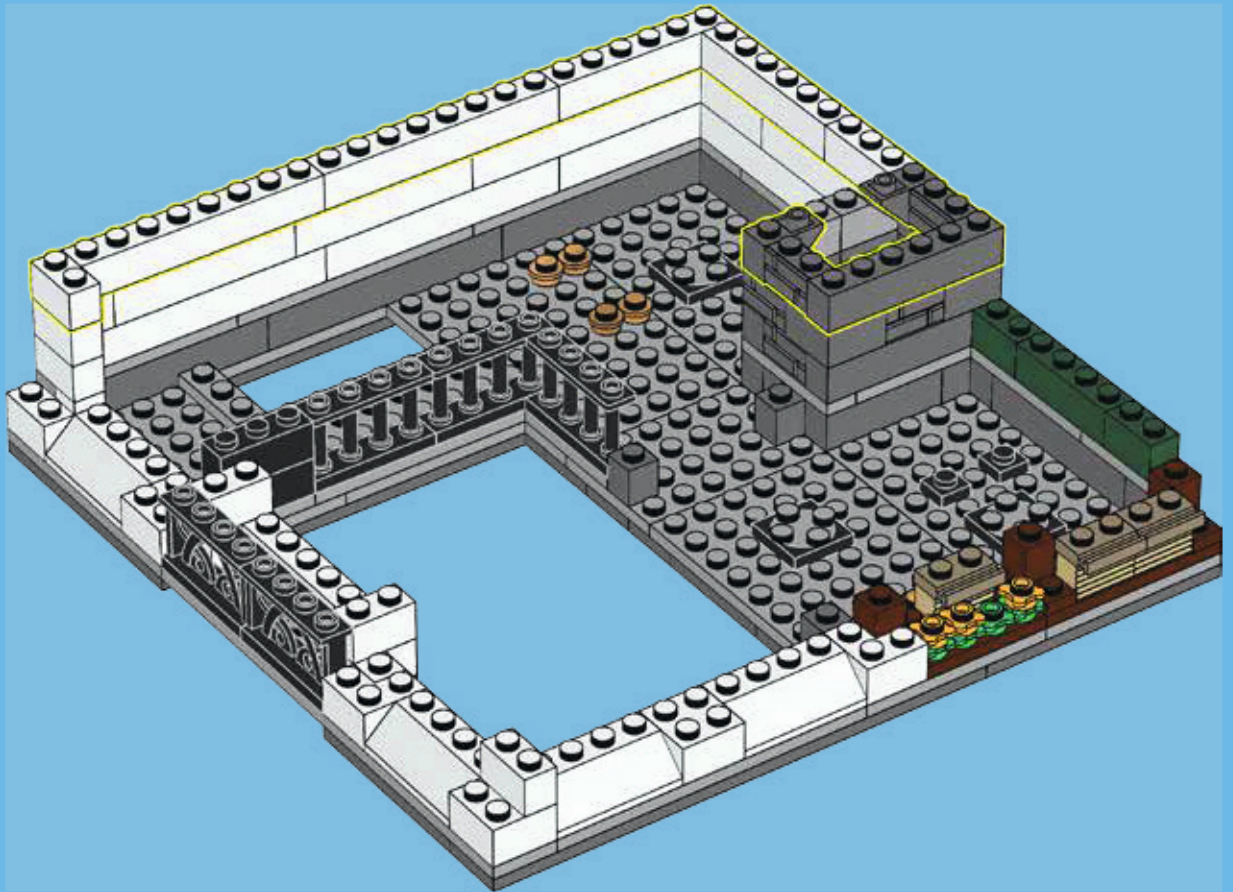

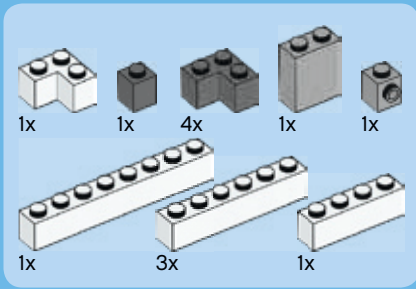

151

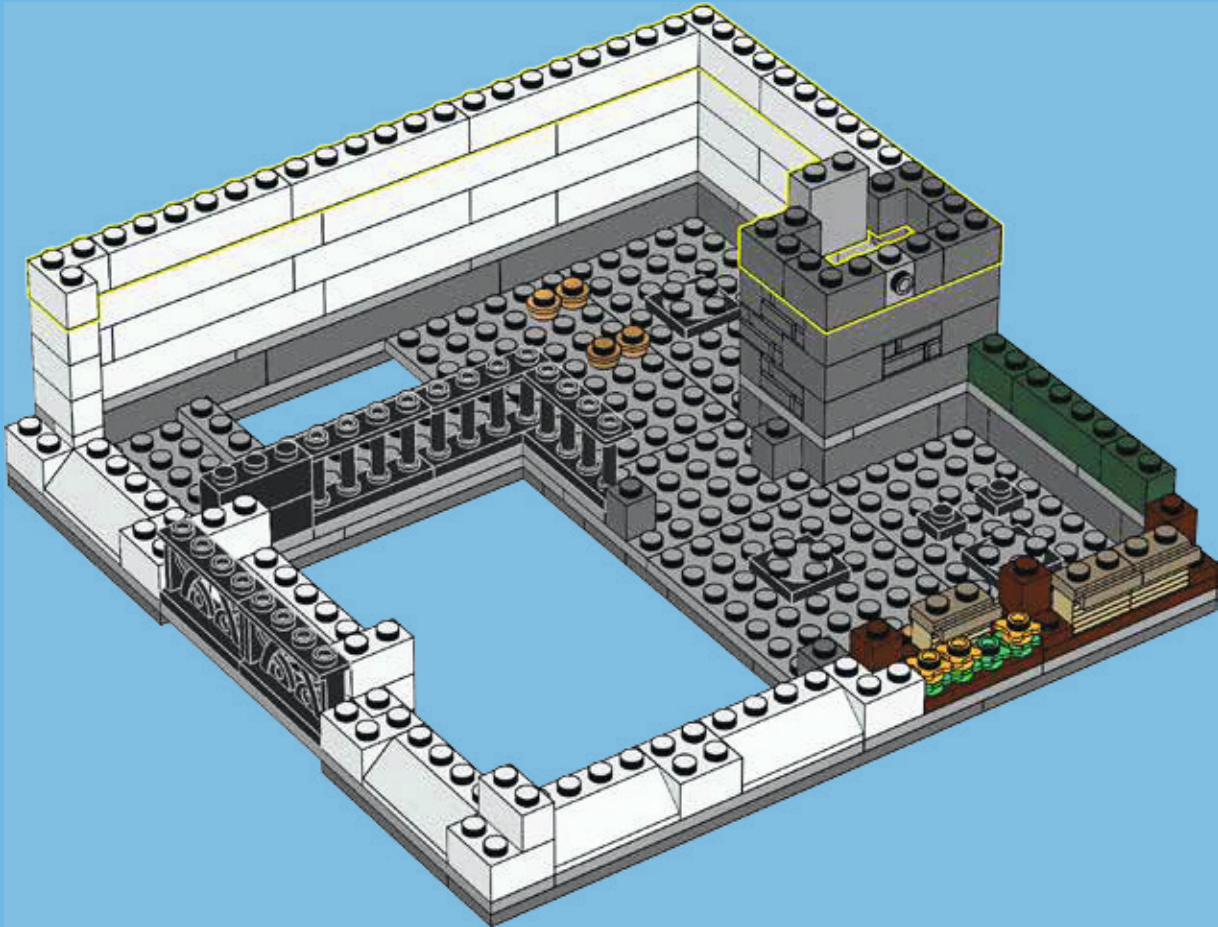

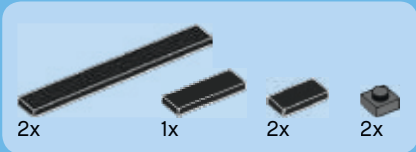

152

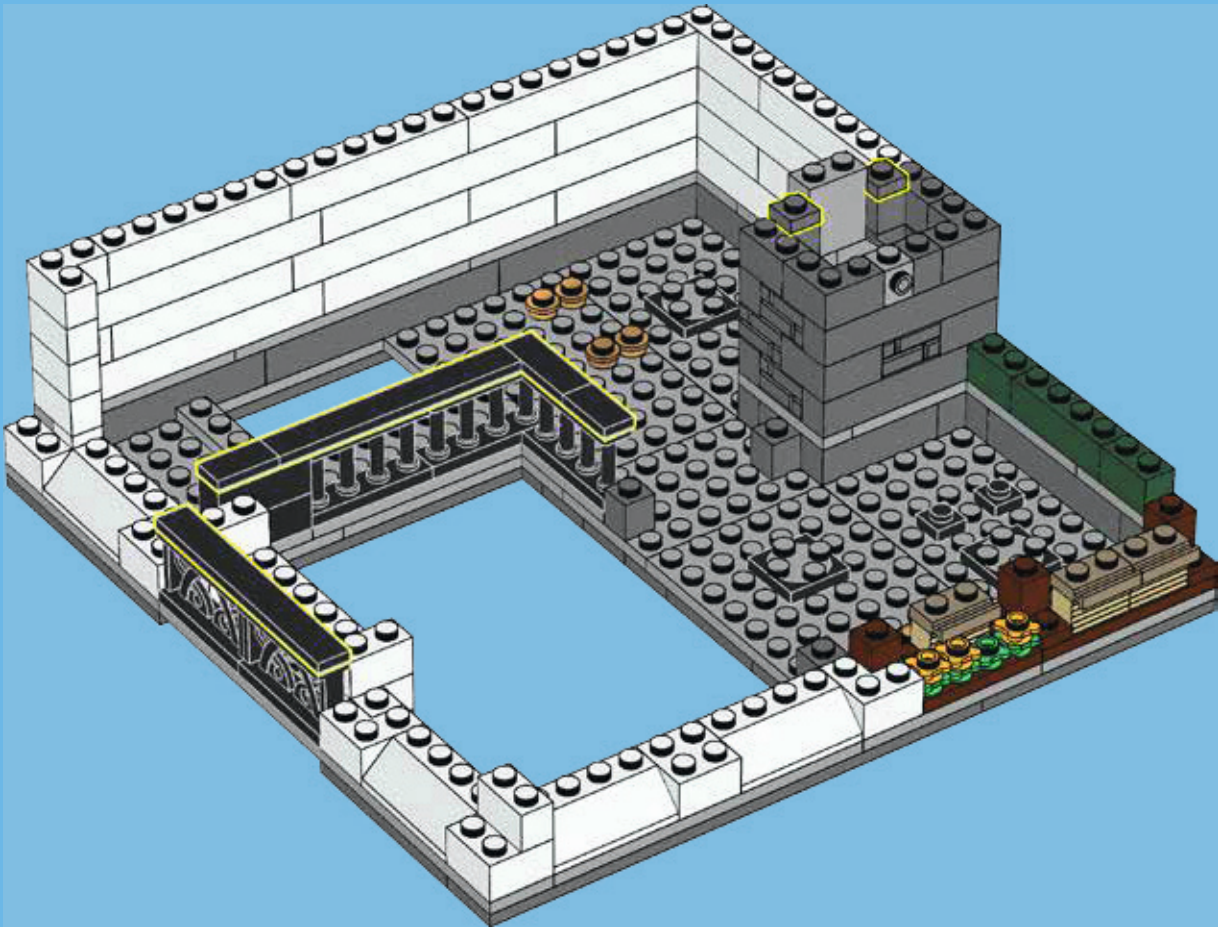

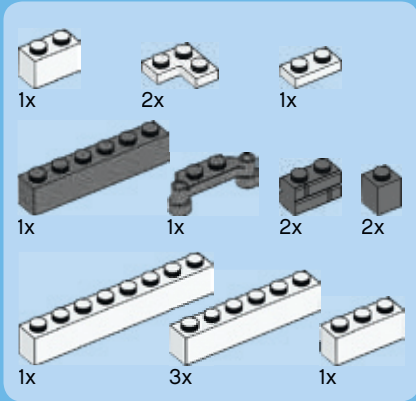

153

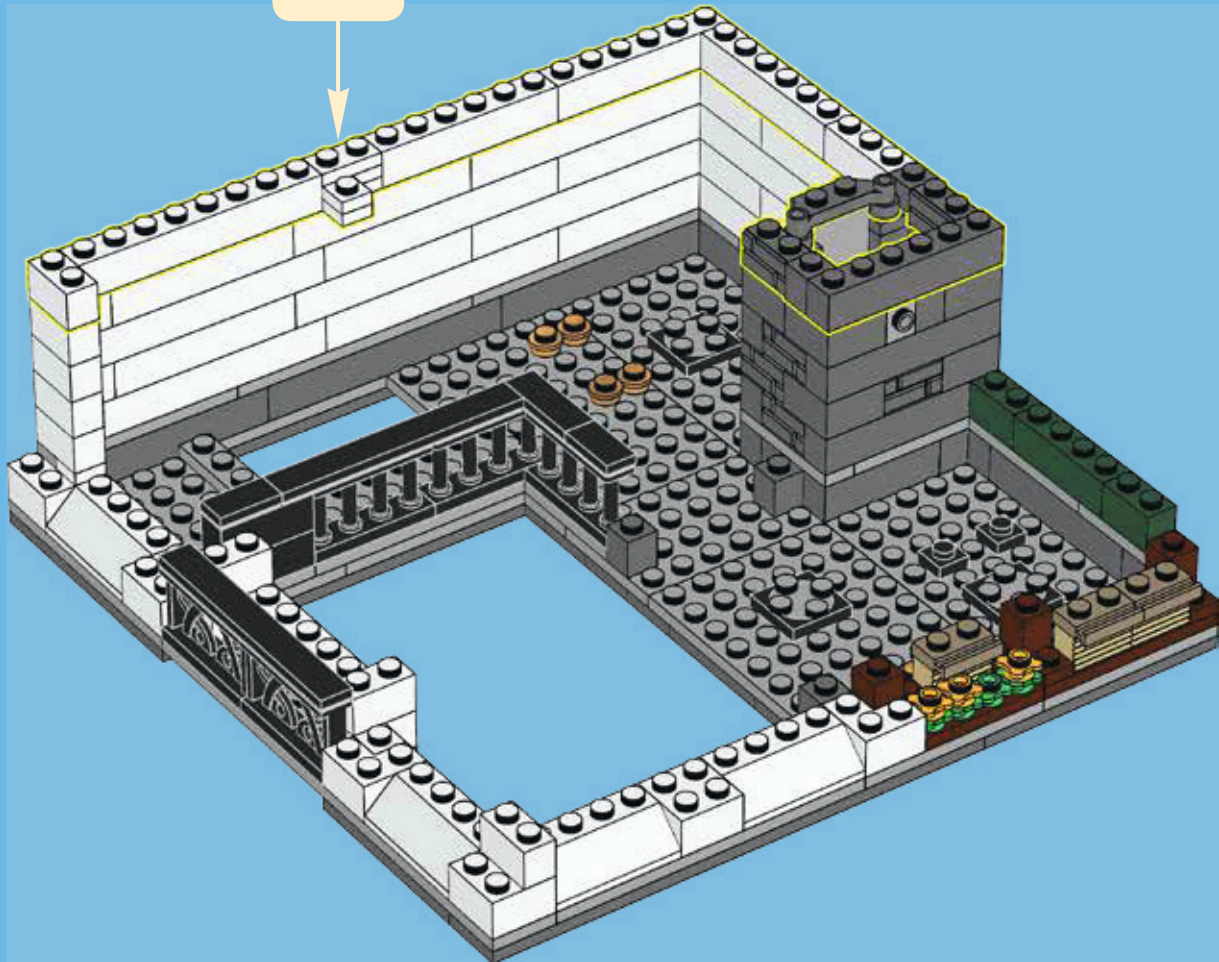
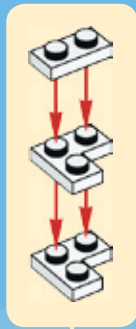

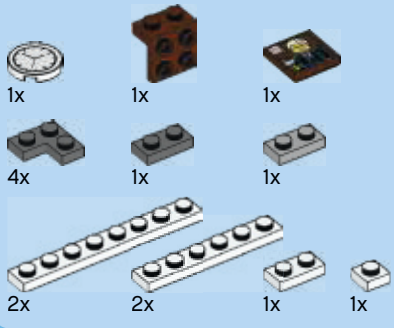

154

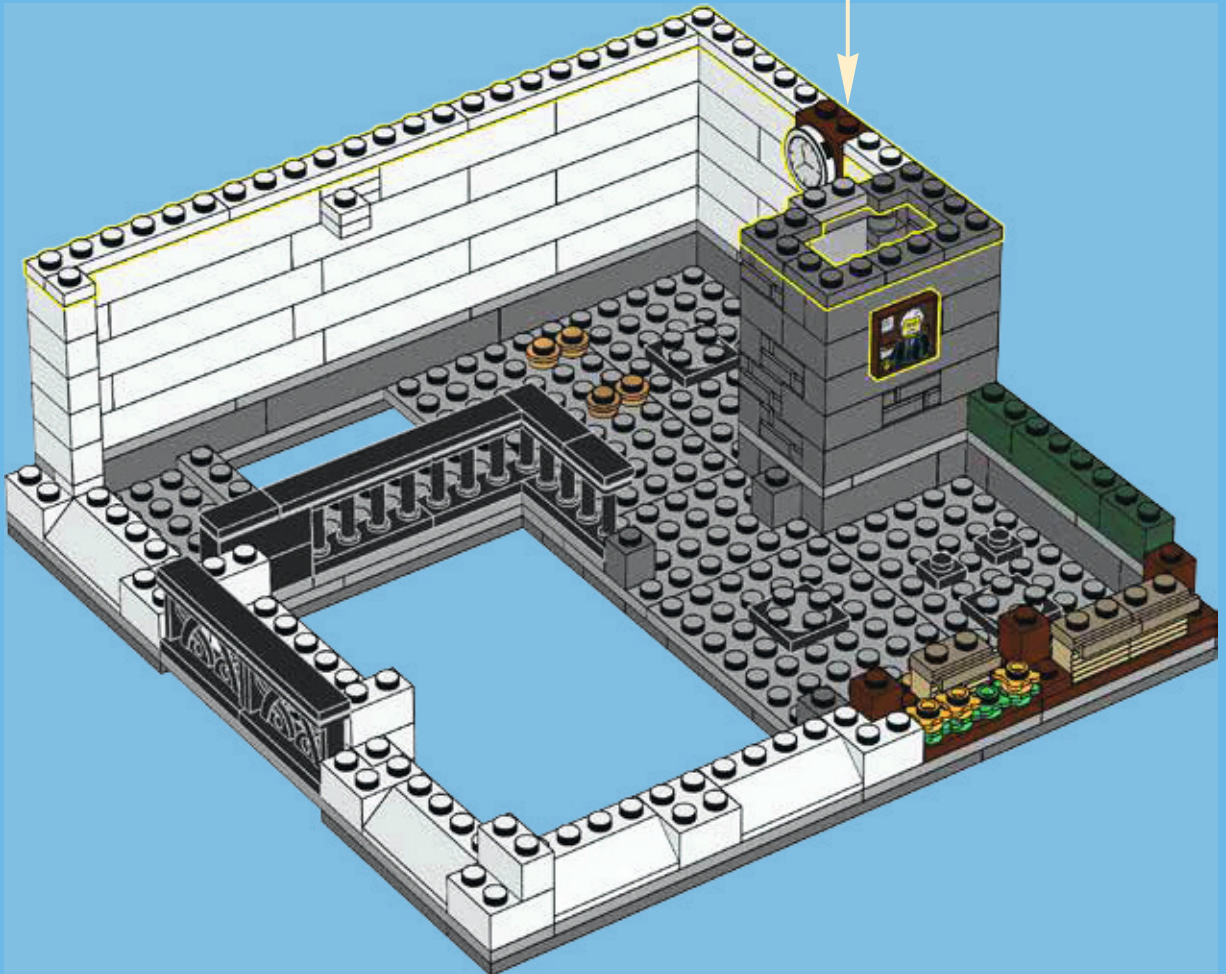
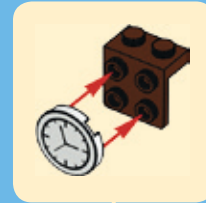



1x



1x

155

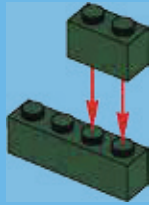

1x



2x

156

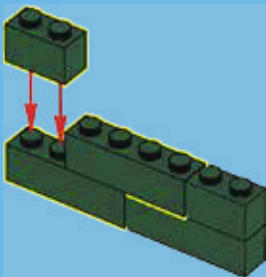

2x



3x

157

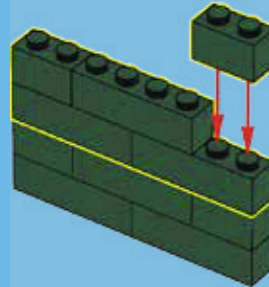

2x

158

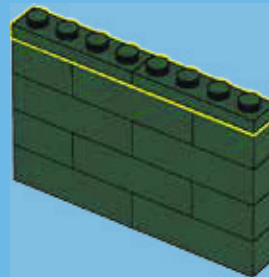

159

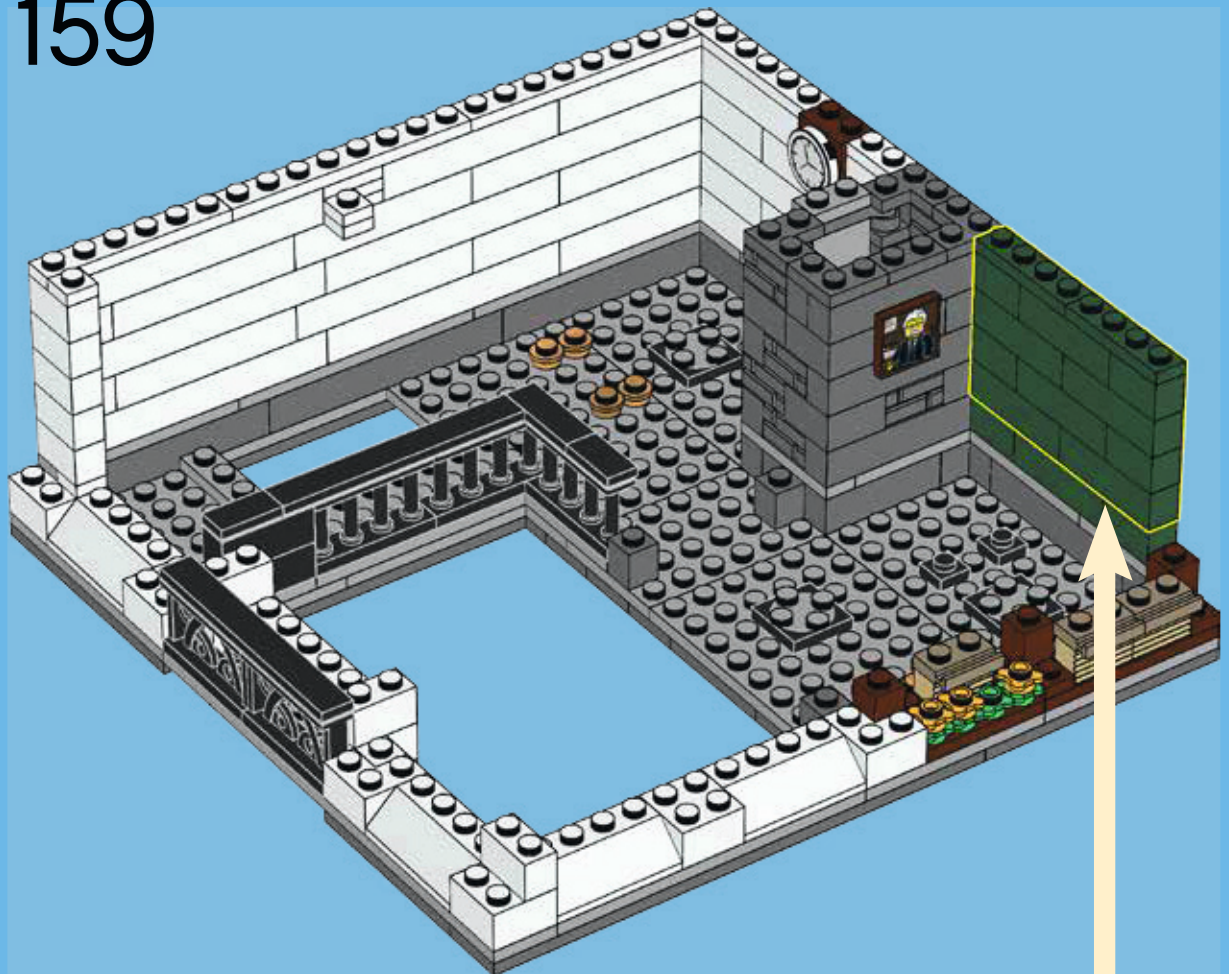

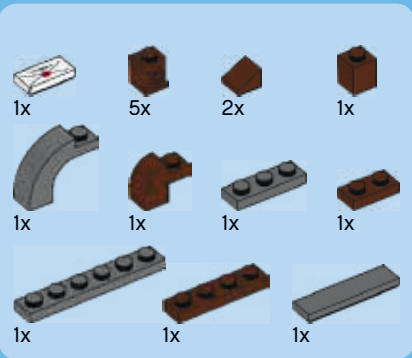

160

1



2



3

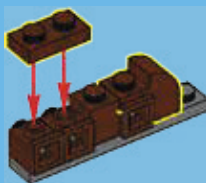

4

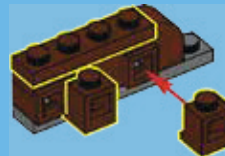

5

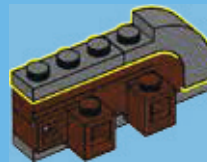

6



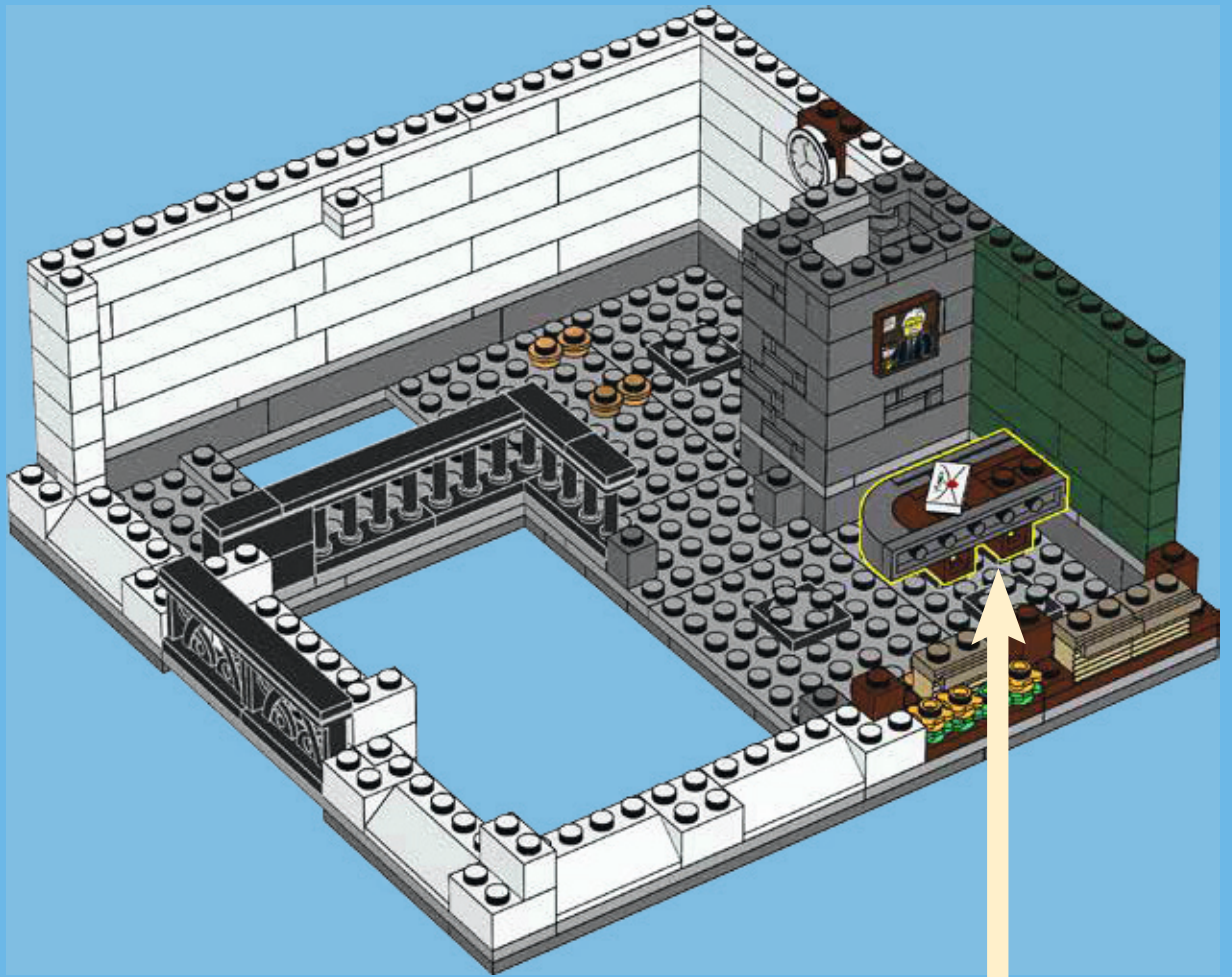

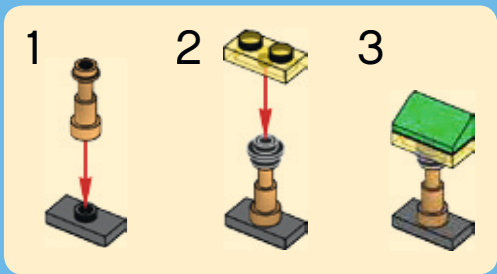
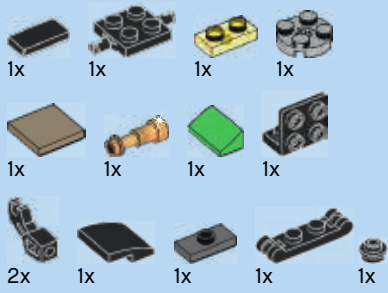

161

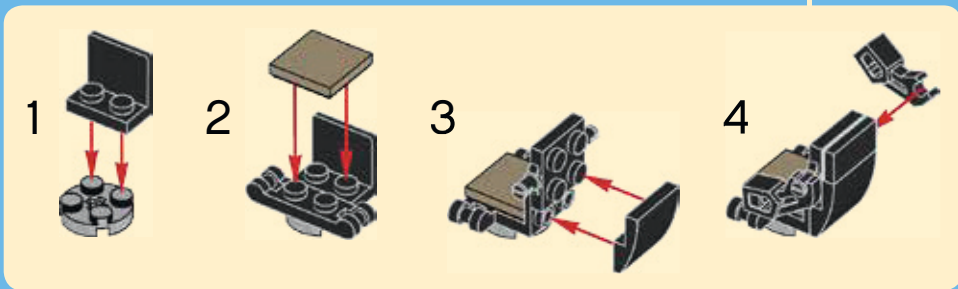
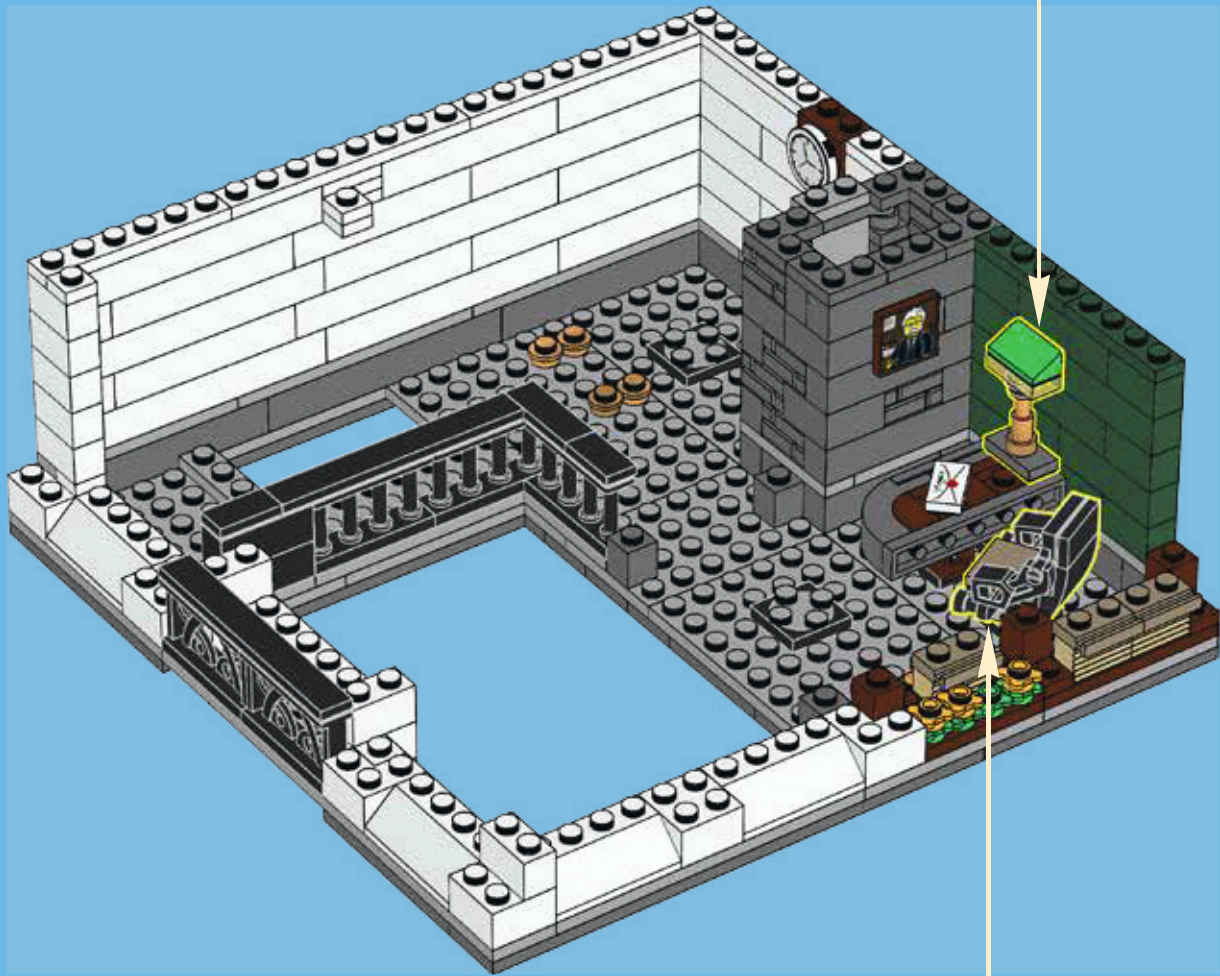



162

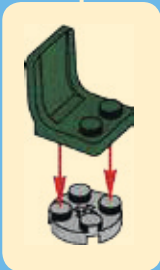
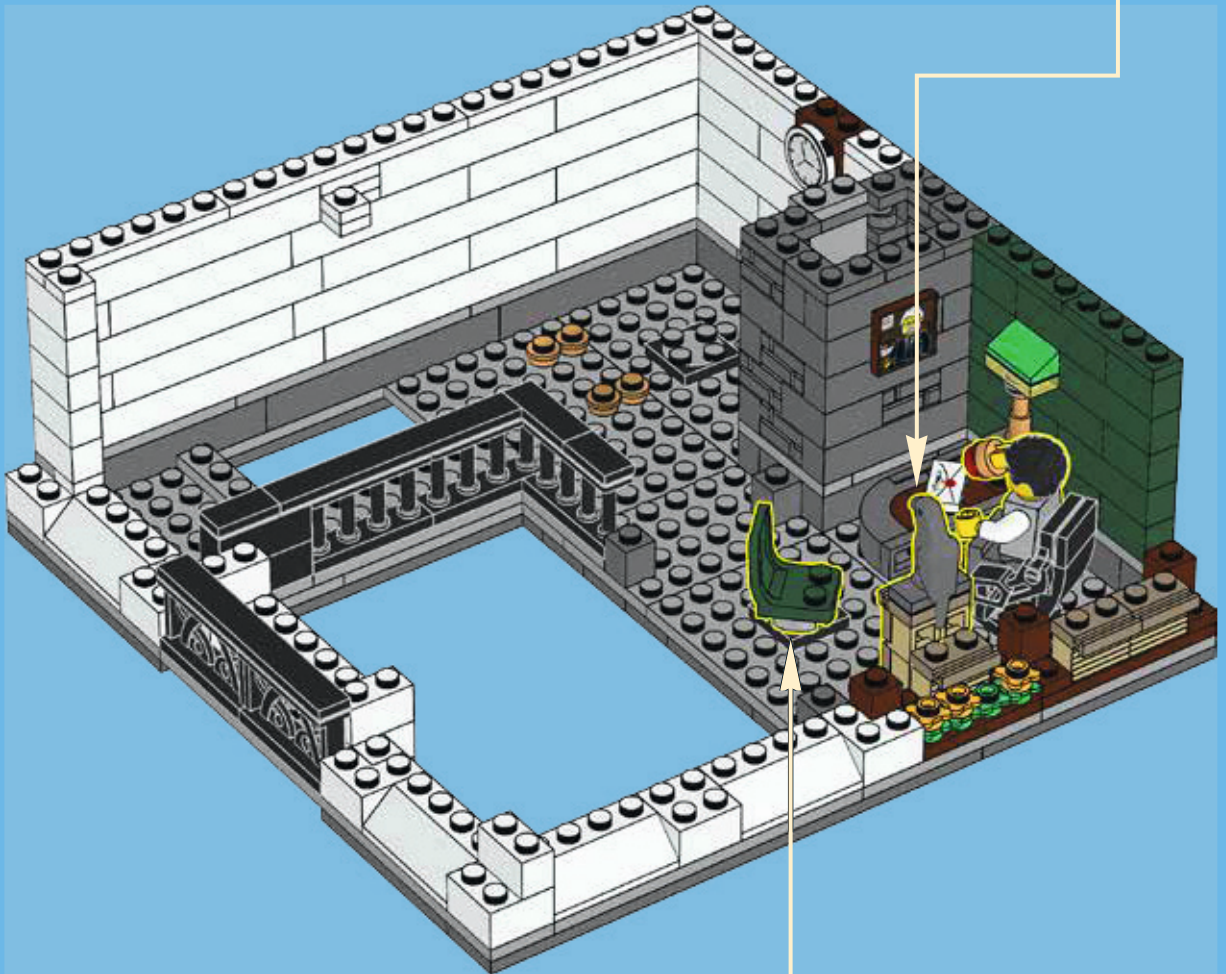
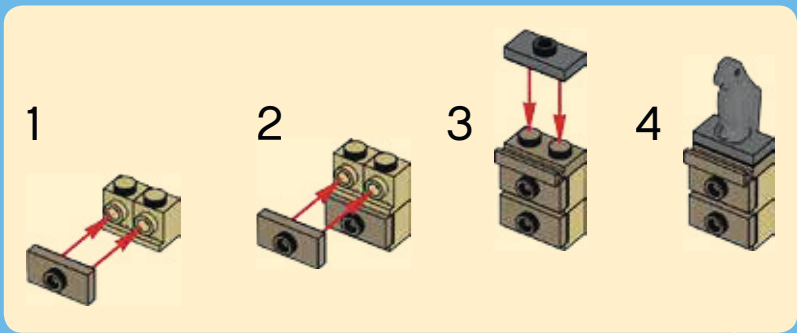

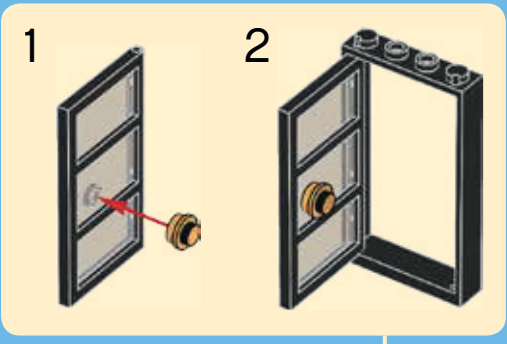
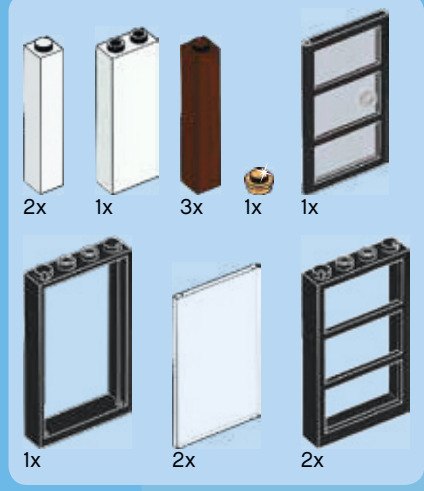

163

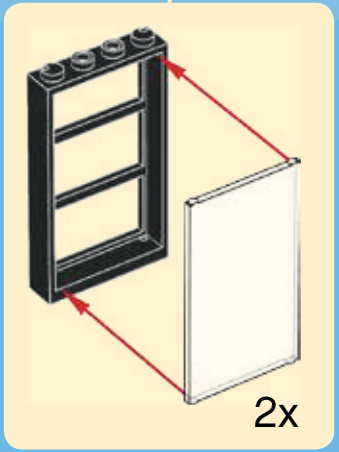
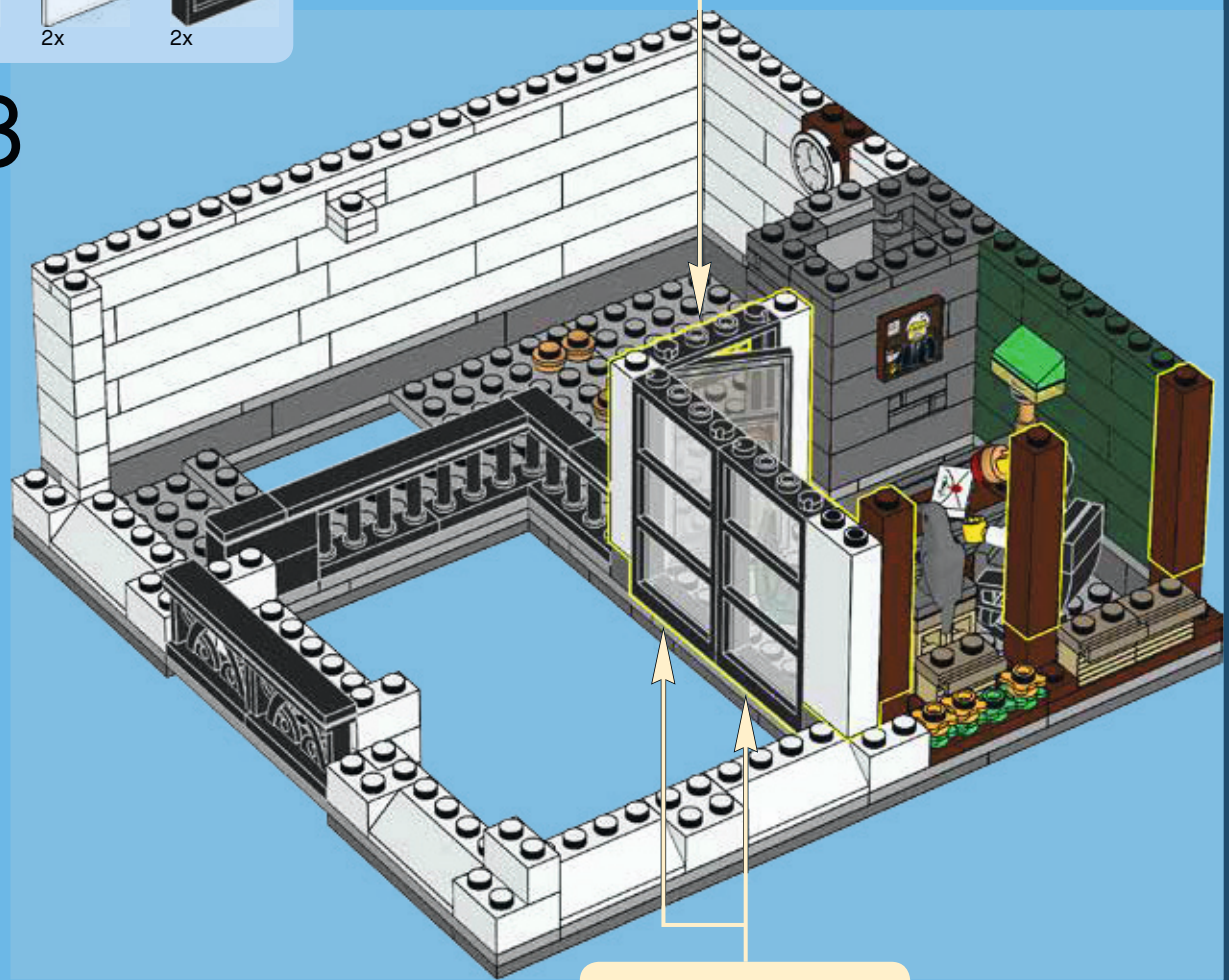

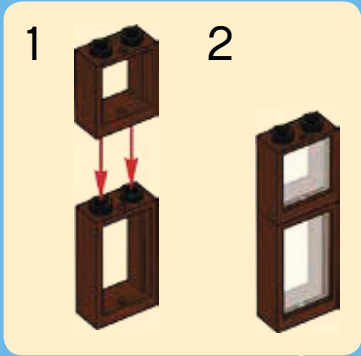
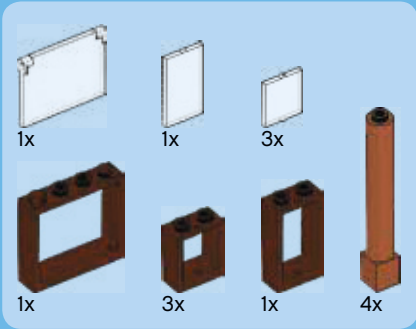

164

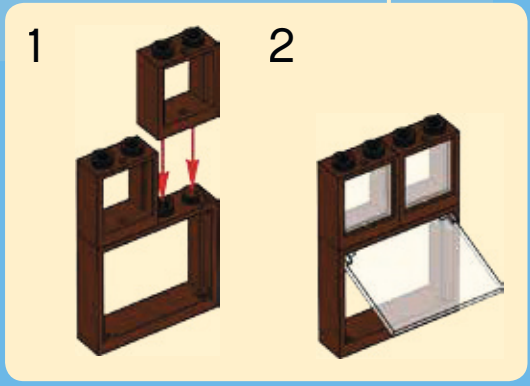
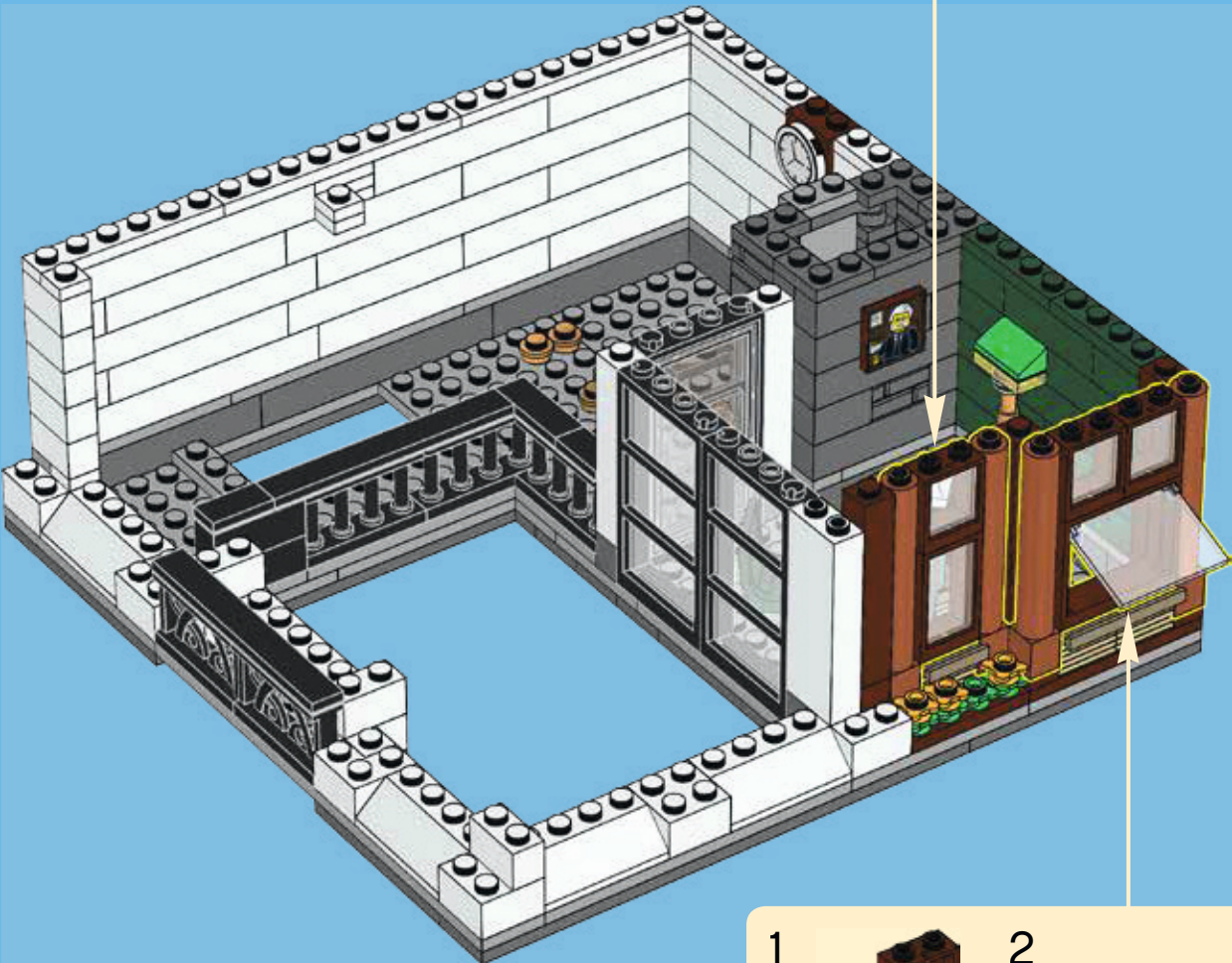

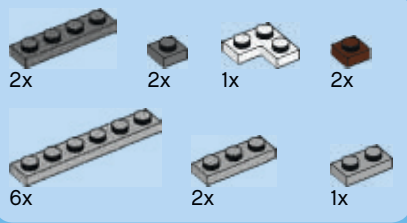

165

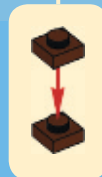
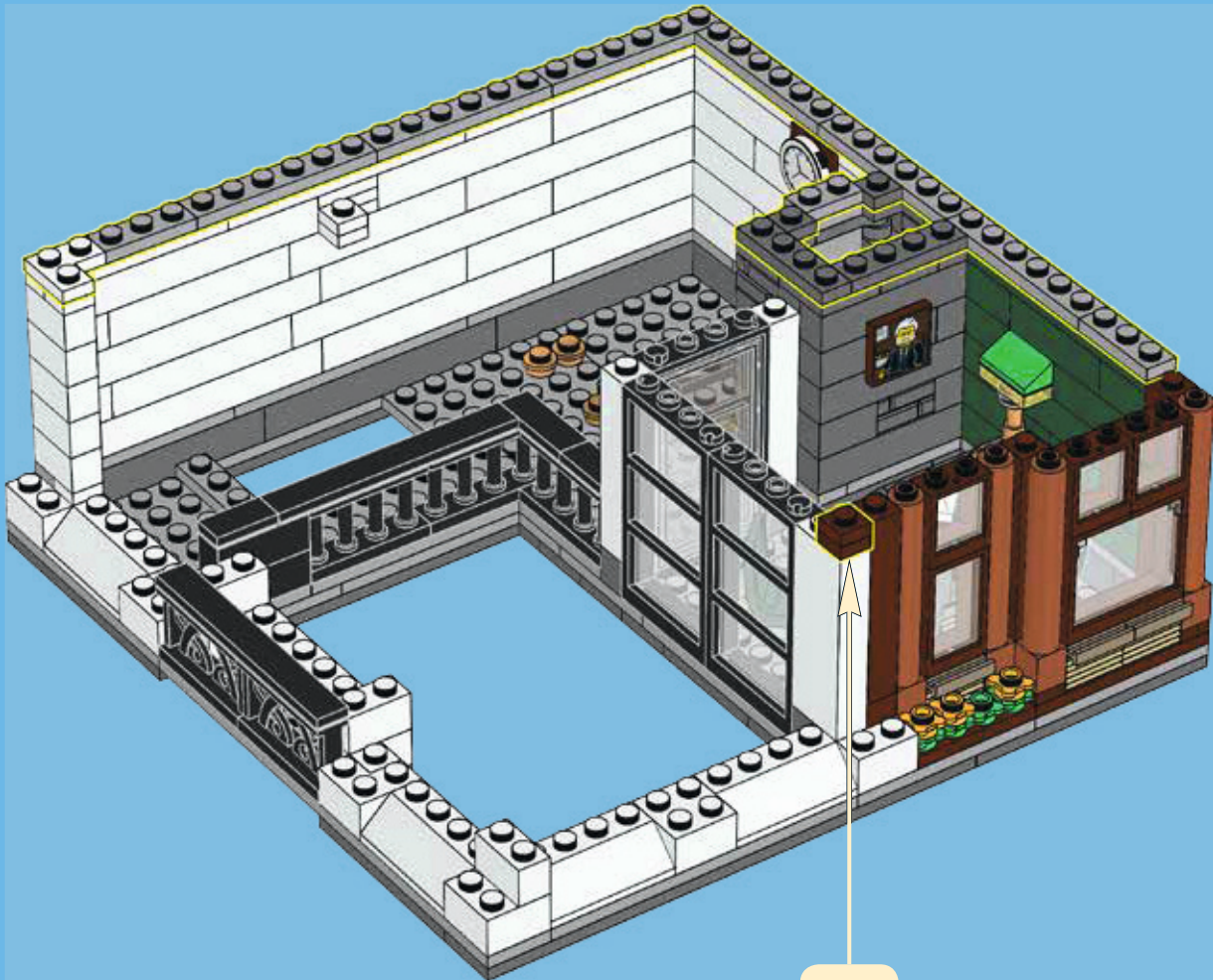



166

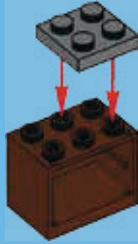

167

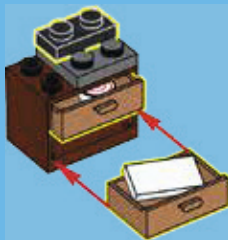

168



169





1x



1x

170



1x



1x

171



172

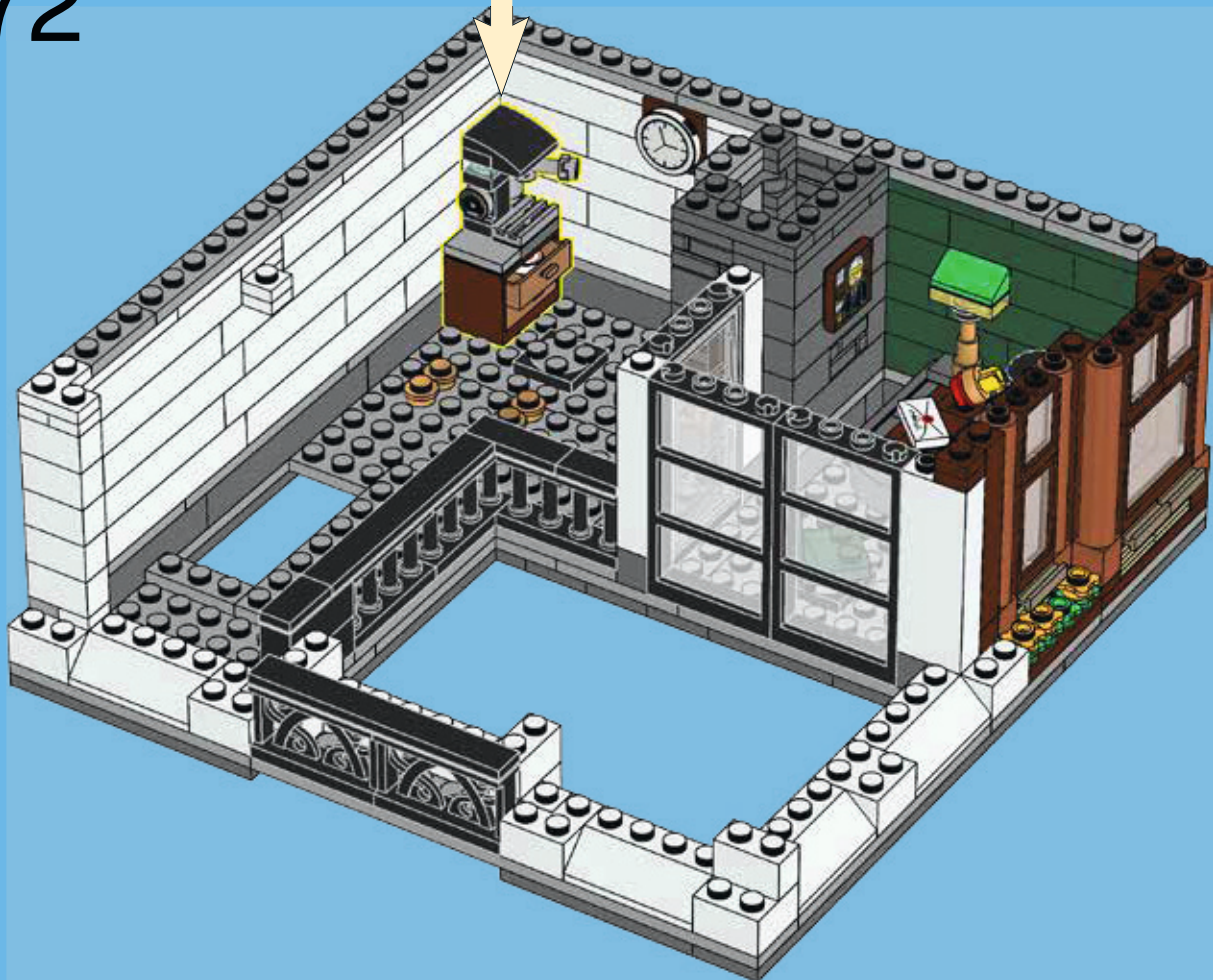

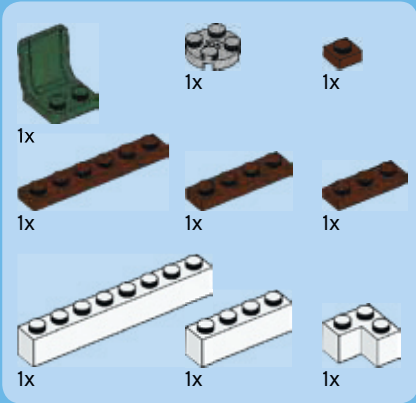

173

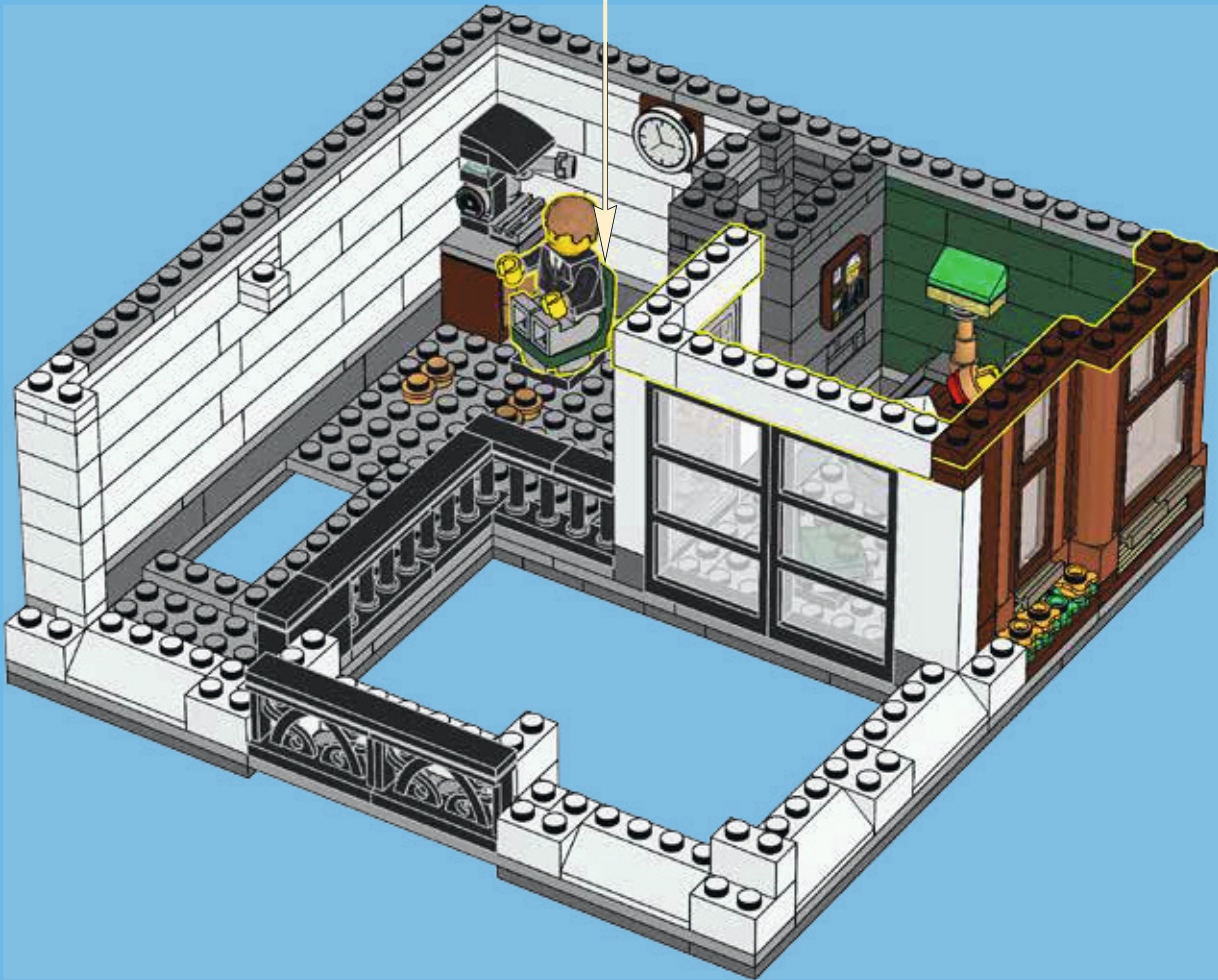



1x



174



4x

175

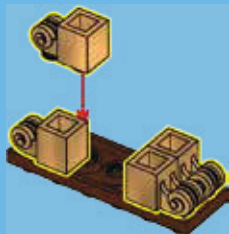

2x

176



1x



3x

177

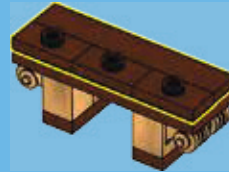

1x



1x



2x

178

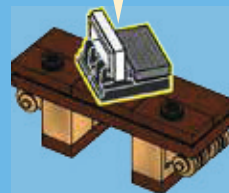

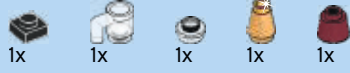

179

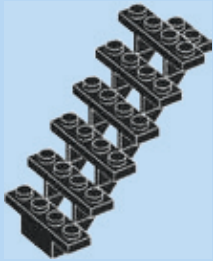
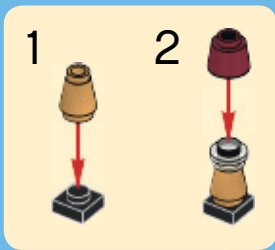

1x

180





3x



18x



18x

181



3x

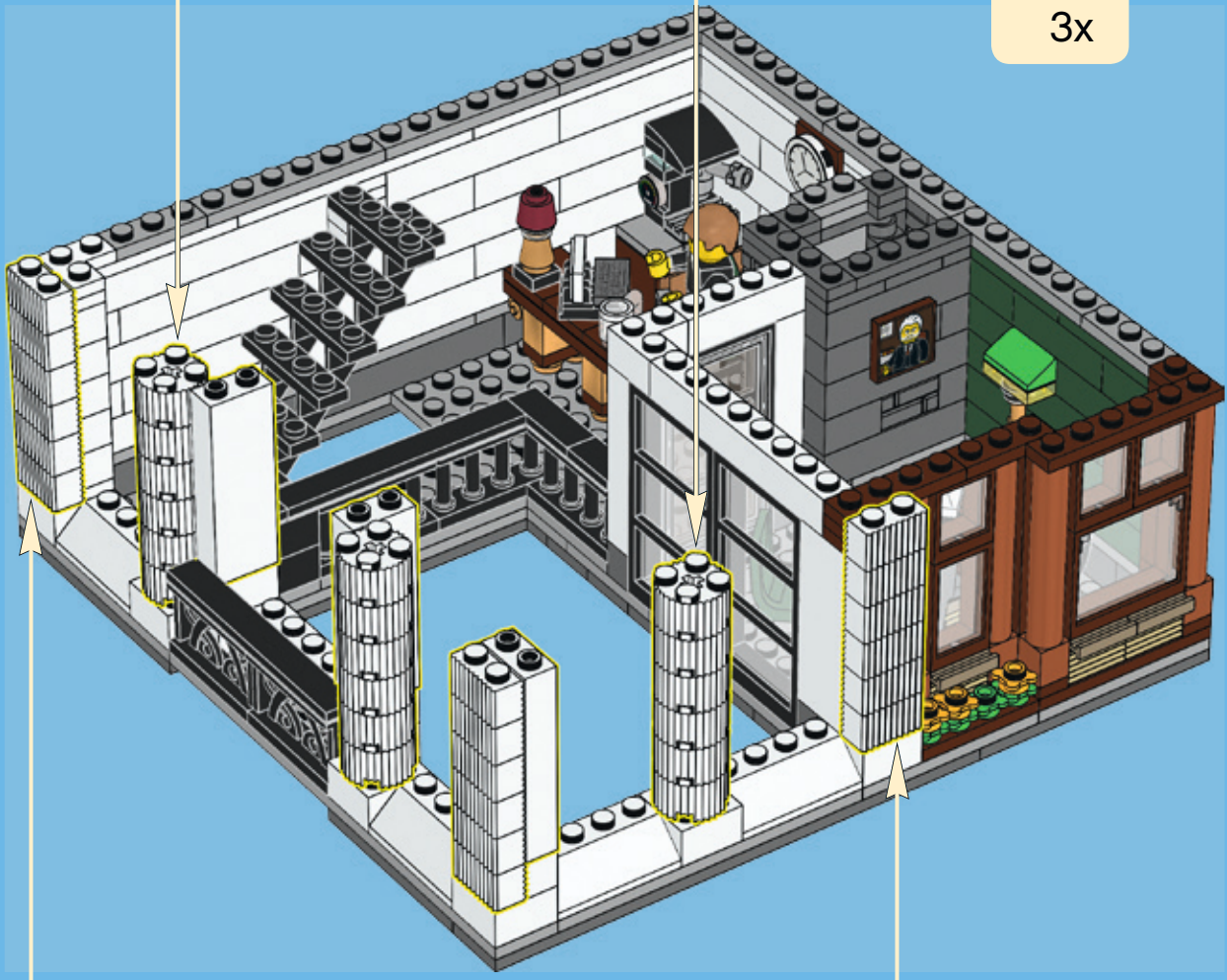

3x



22x



22x

182

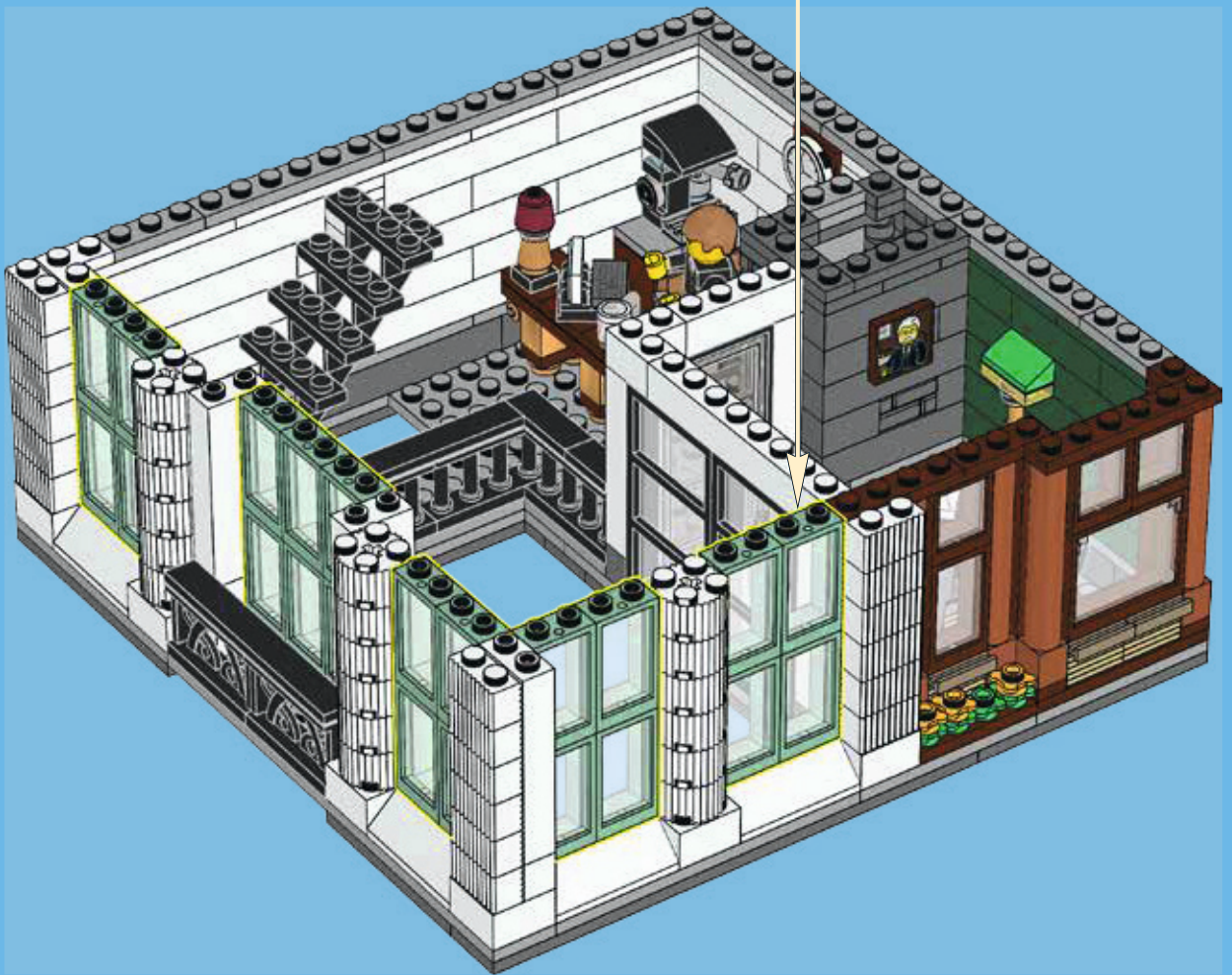
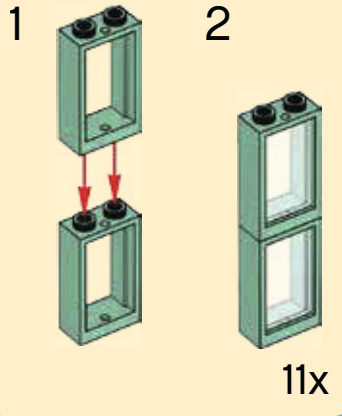

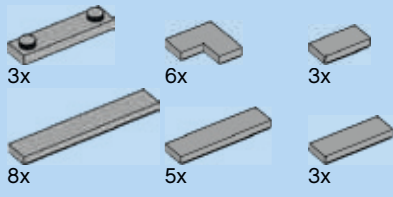

183

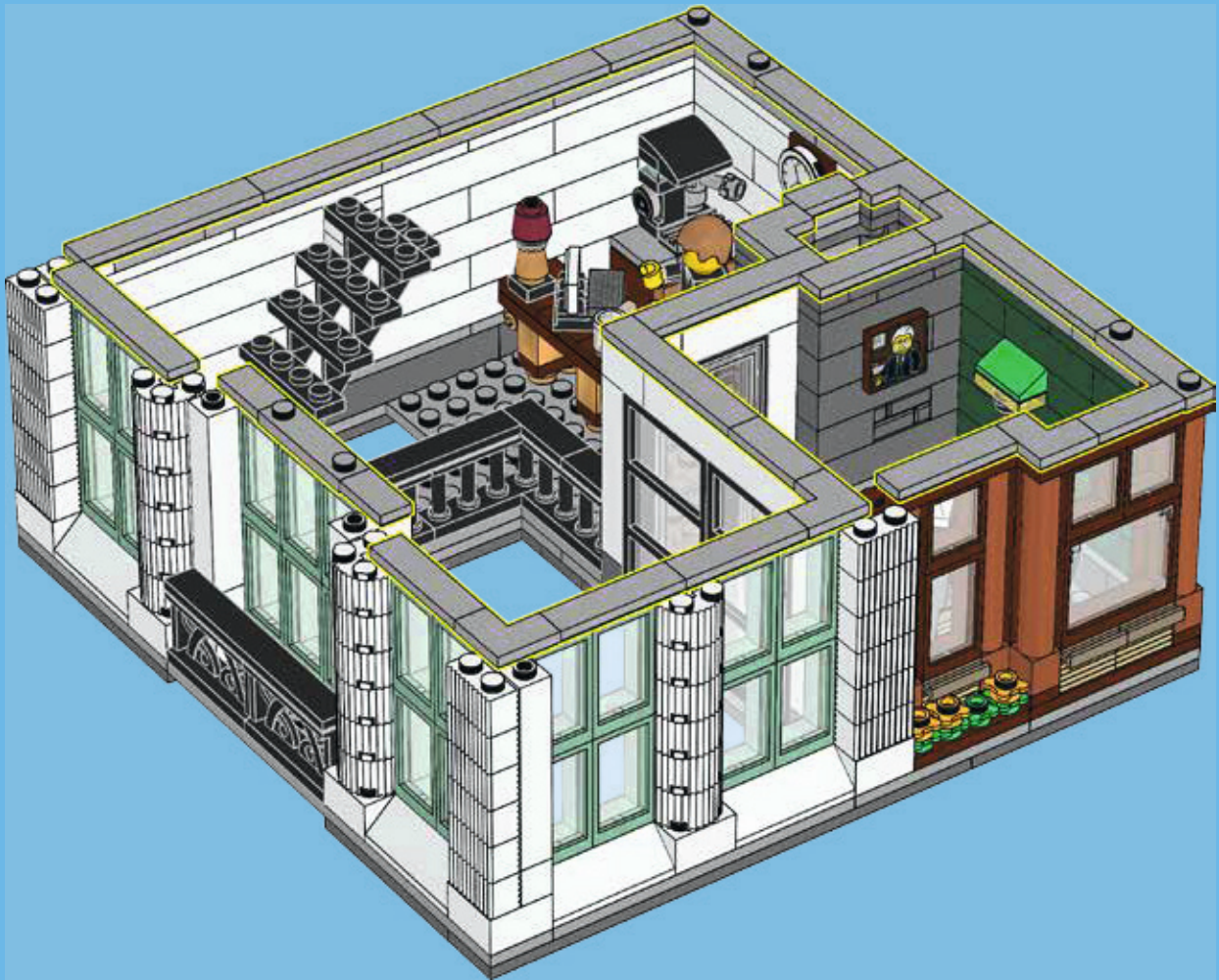



1x



2x



1x



1x



5x

184

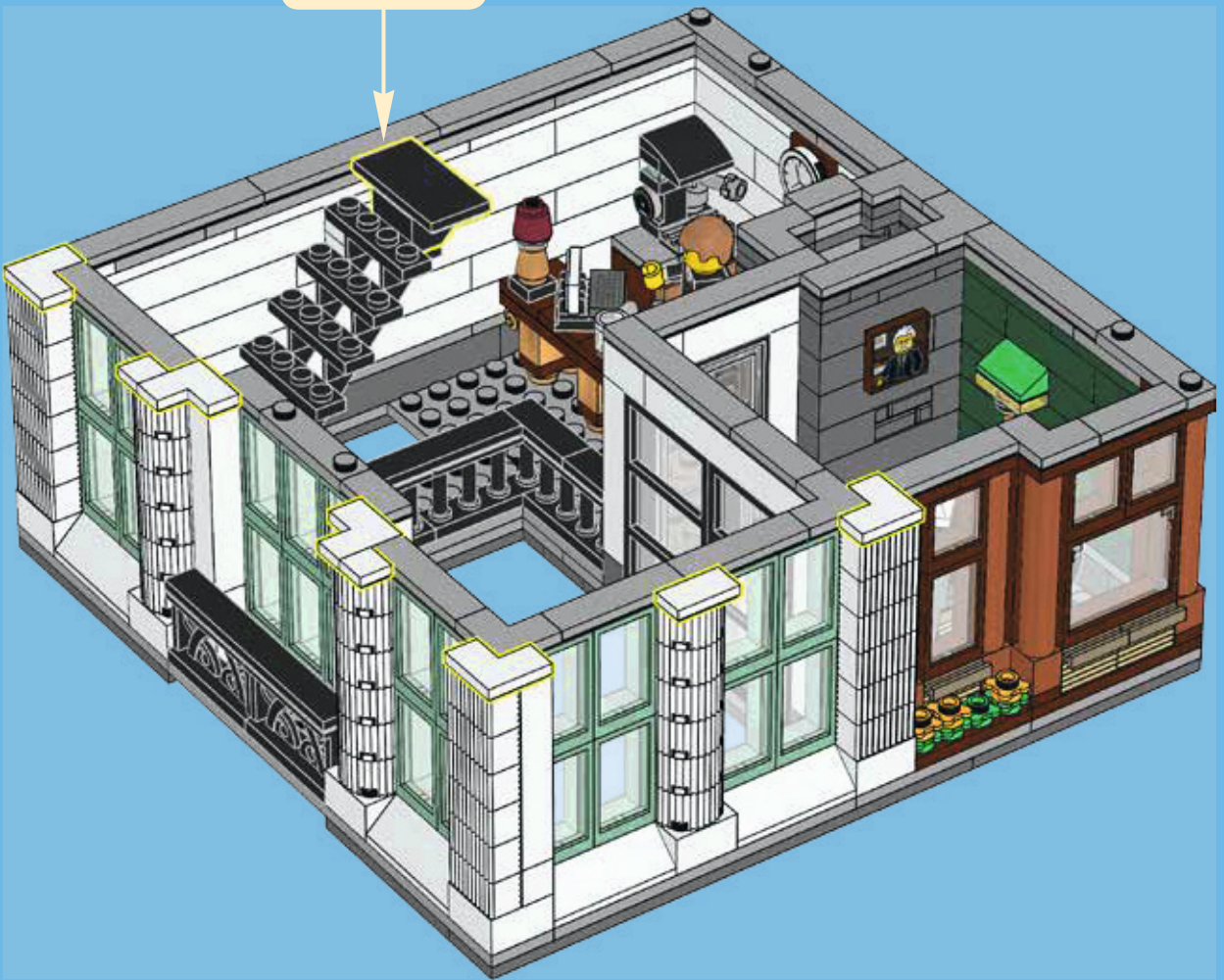
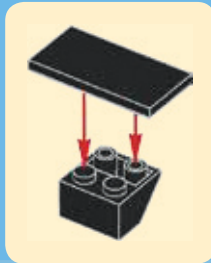





1x



2x

186



1x



1x

187



1x



1x

188



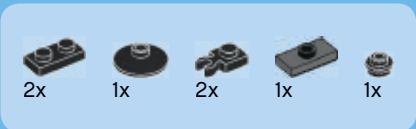

189

- 1
- 2
- 3
- 4

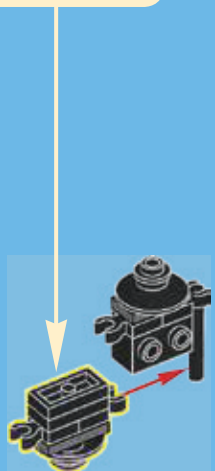

190

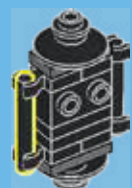

191

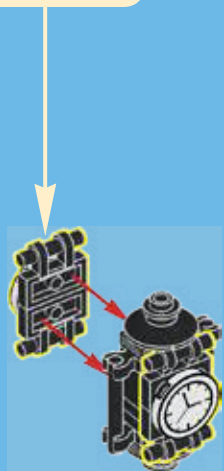
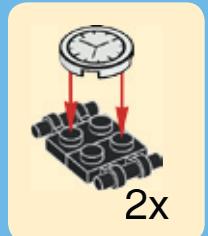

192



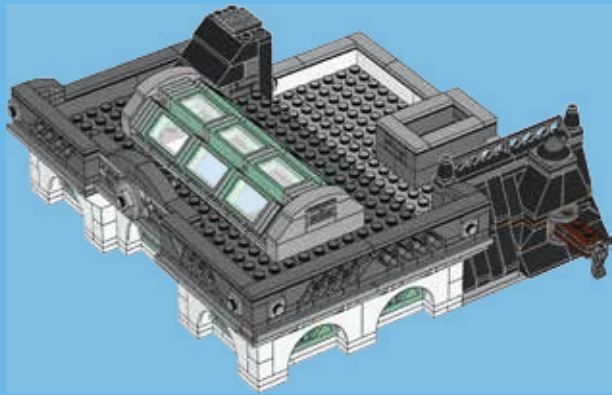
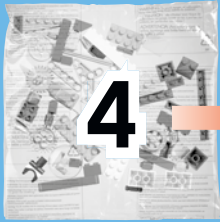

1x



1x

193

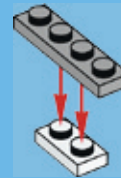

2x

194

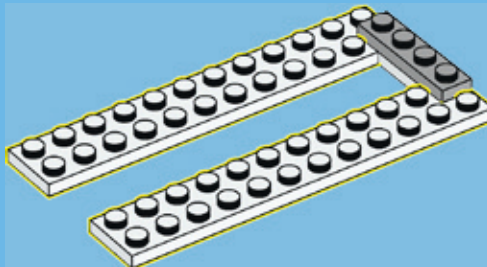

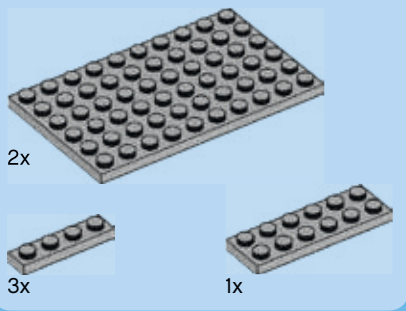

195

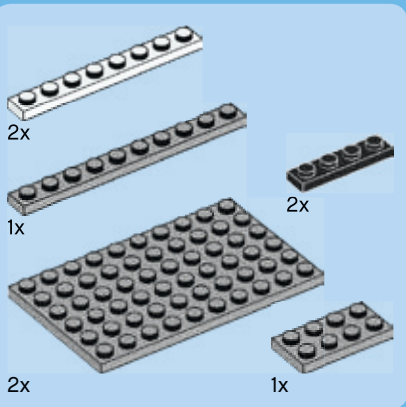
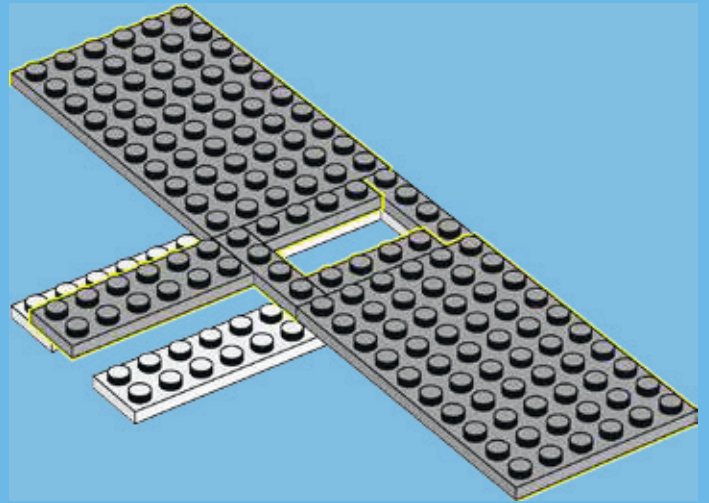

196

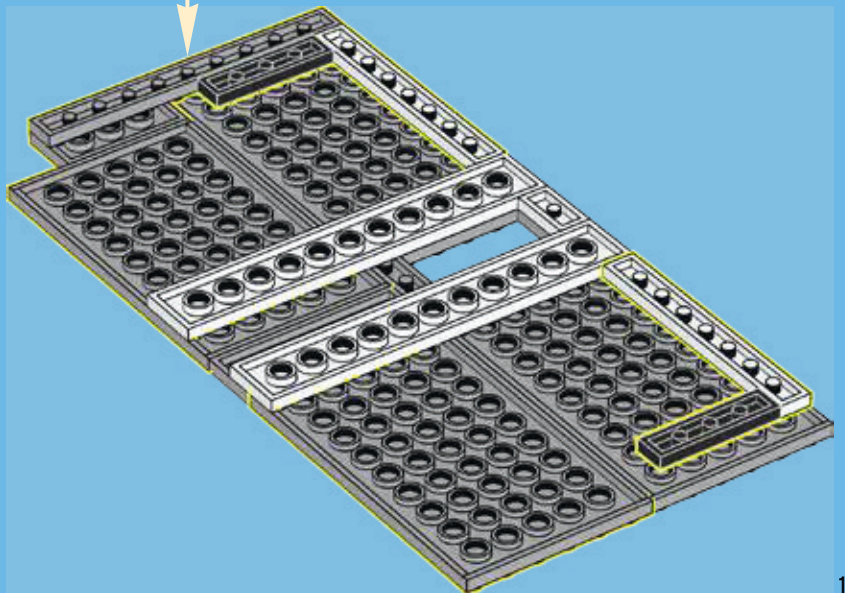
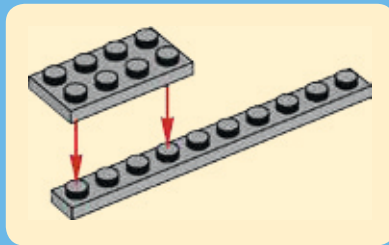

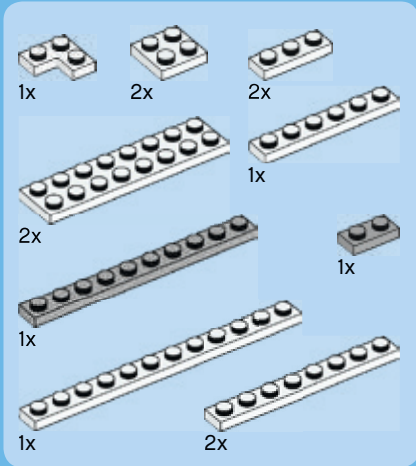

197

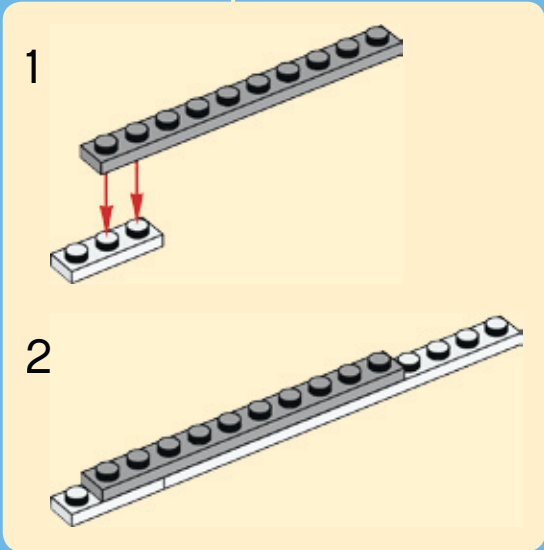
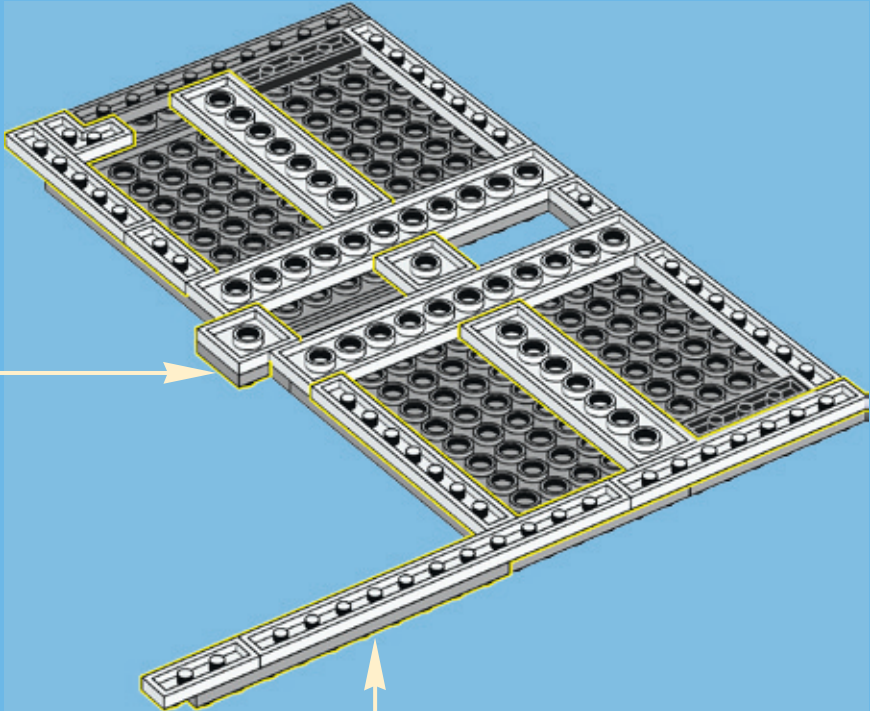
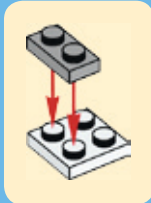

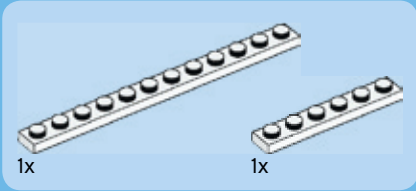
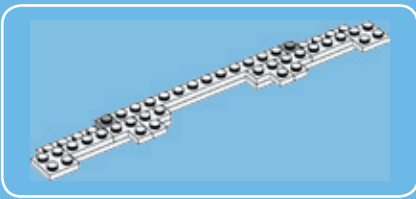

198

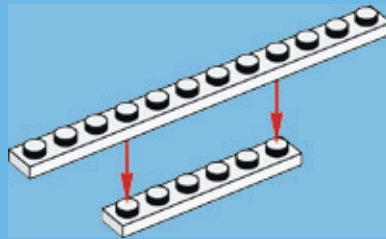

199

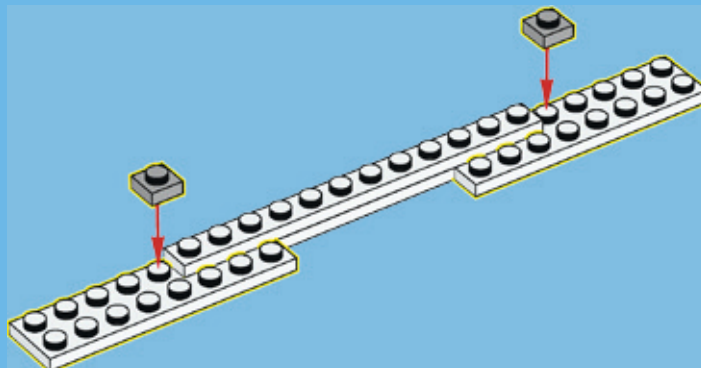



4x



2x



2x

200

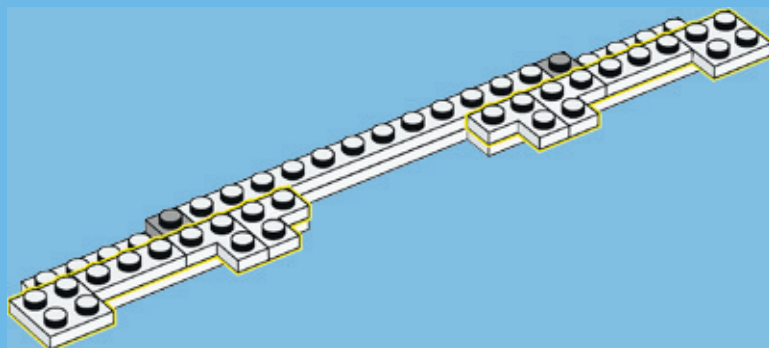

1x



1x

201

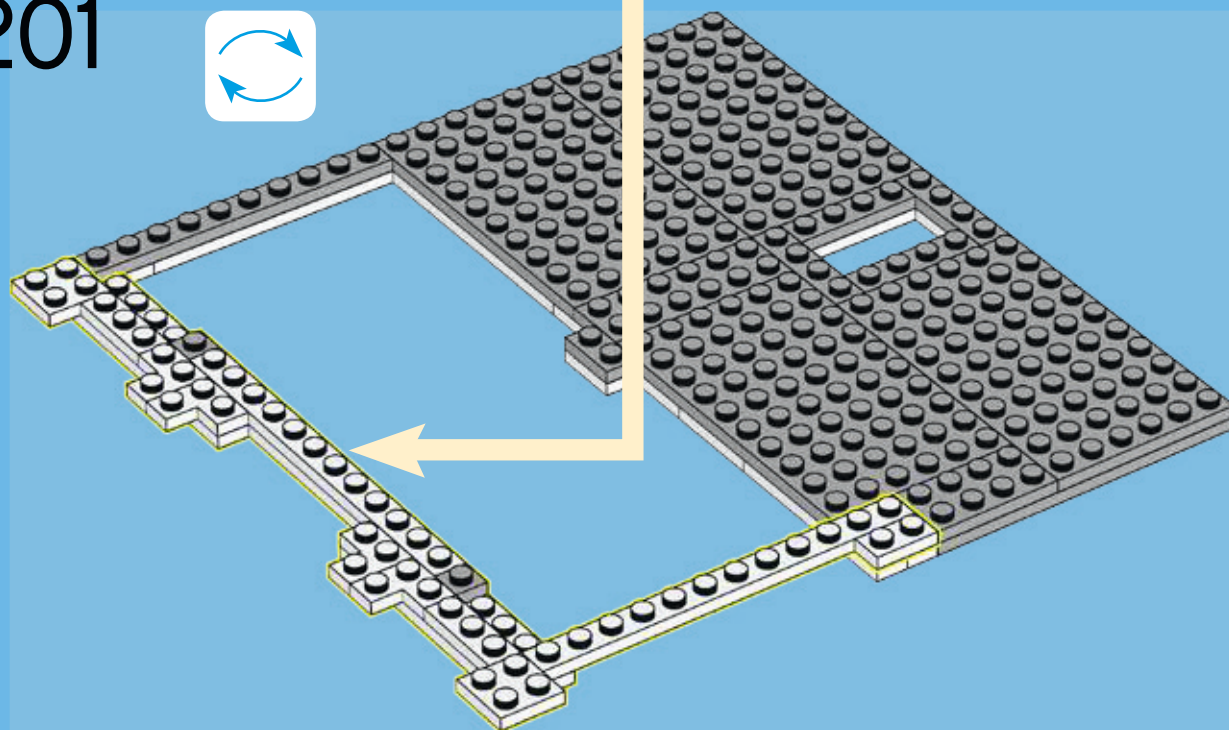



1x



1x



1x



1x



4x

202

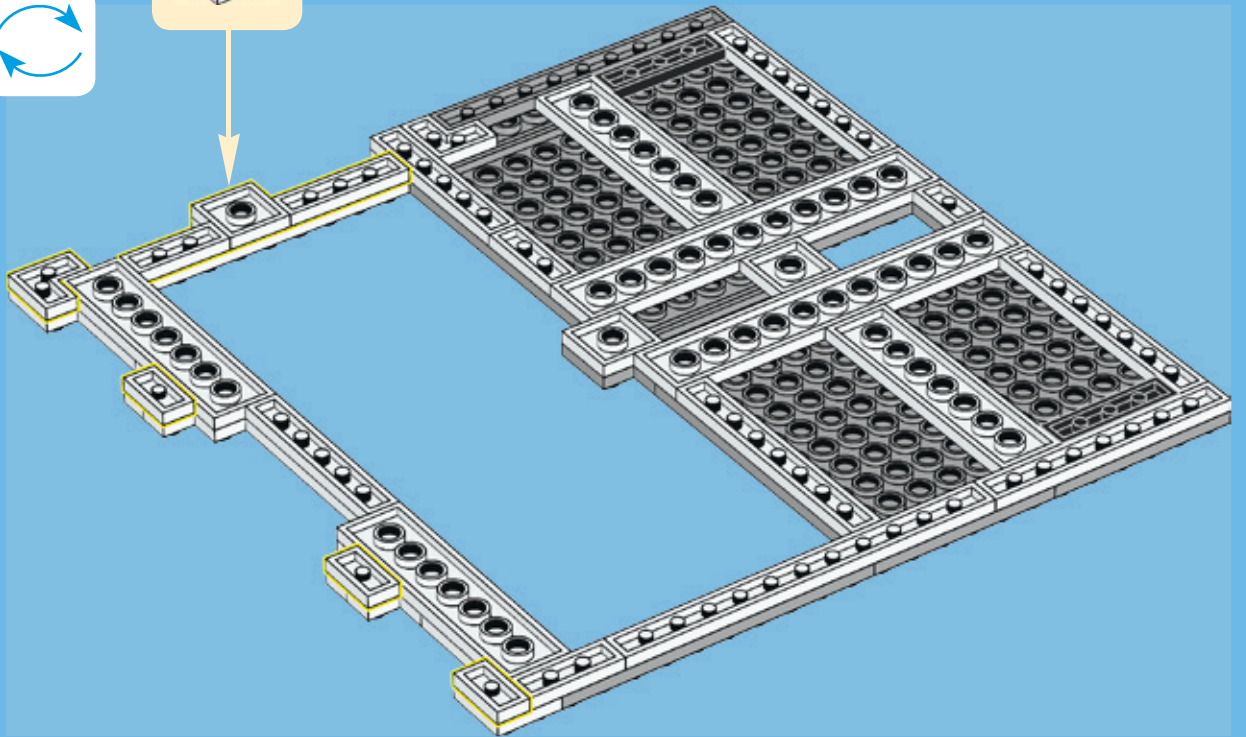
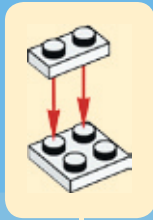

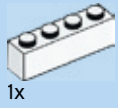

1x



4x



5x



6x



1x



1x

203

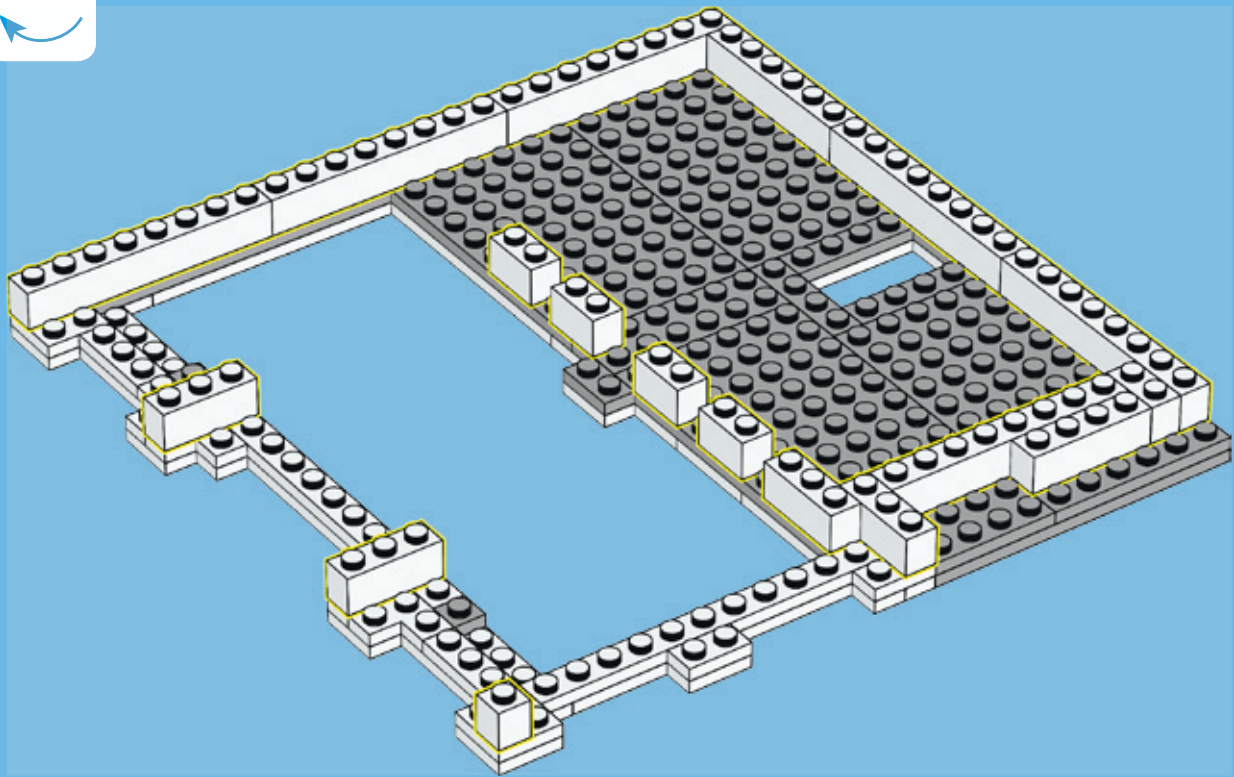

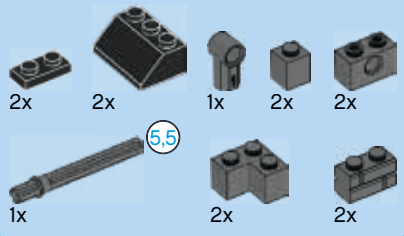

204

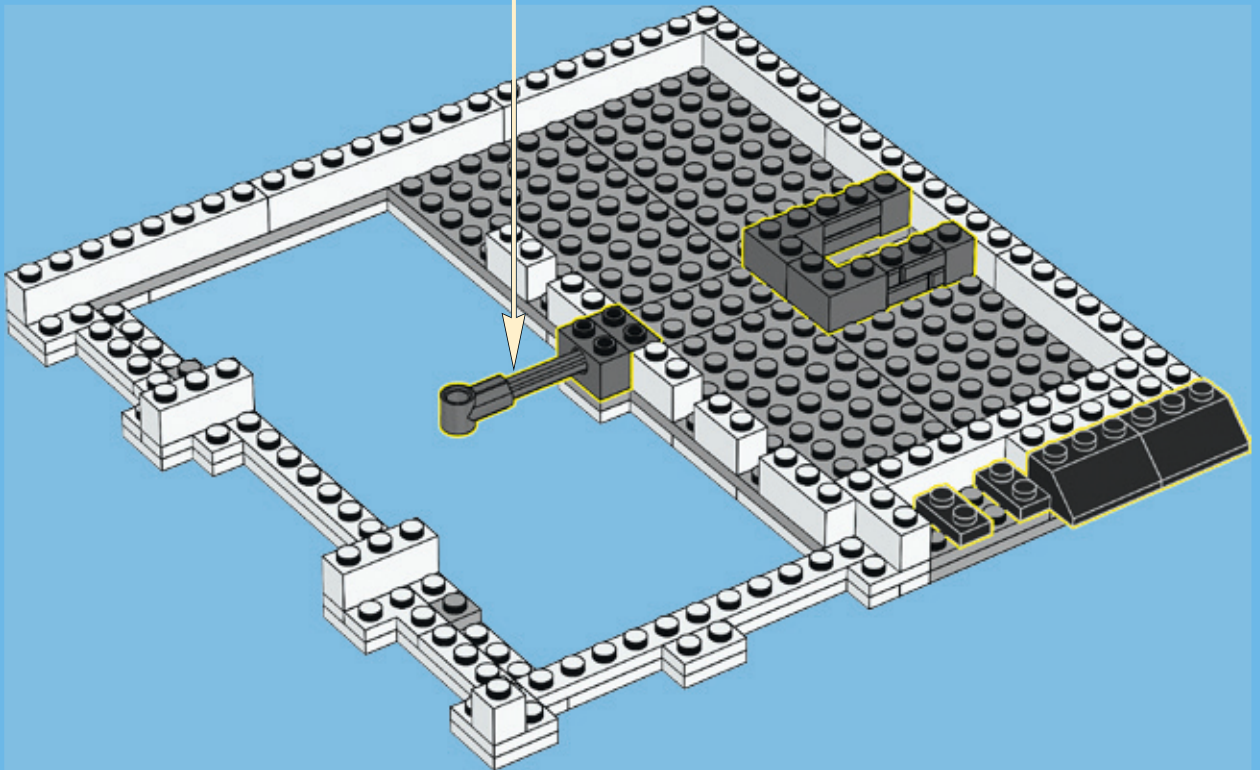
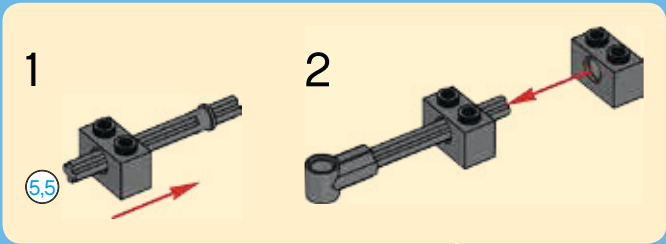



1x

205



4x

206



4x

207



1x



1x



1x

208



4x



4x

209



4x

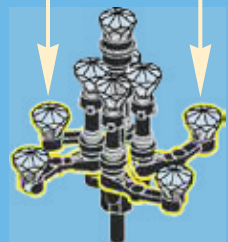

210

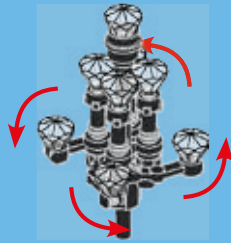

4x



4x



1x

1



2



3



211





1x

212



213

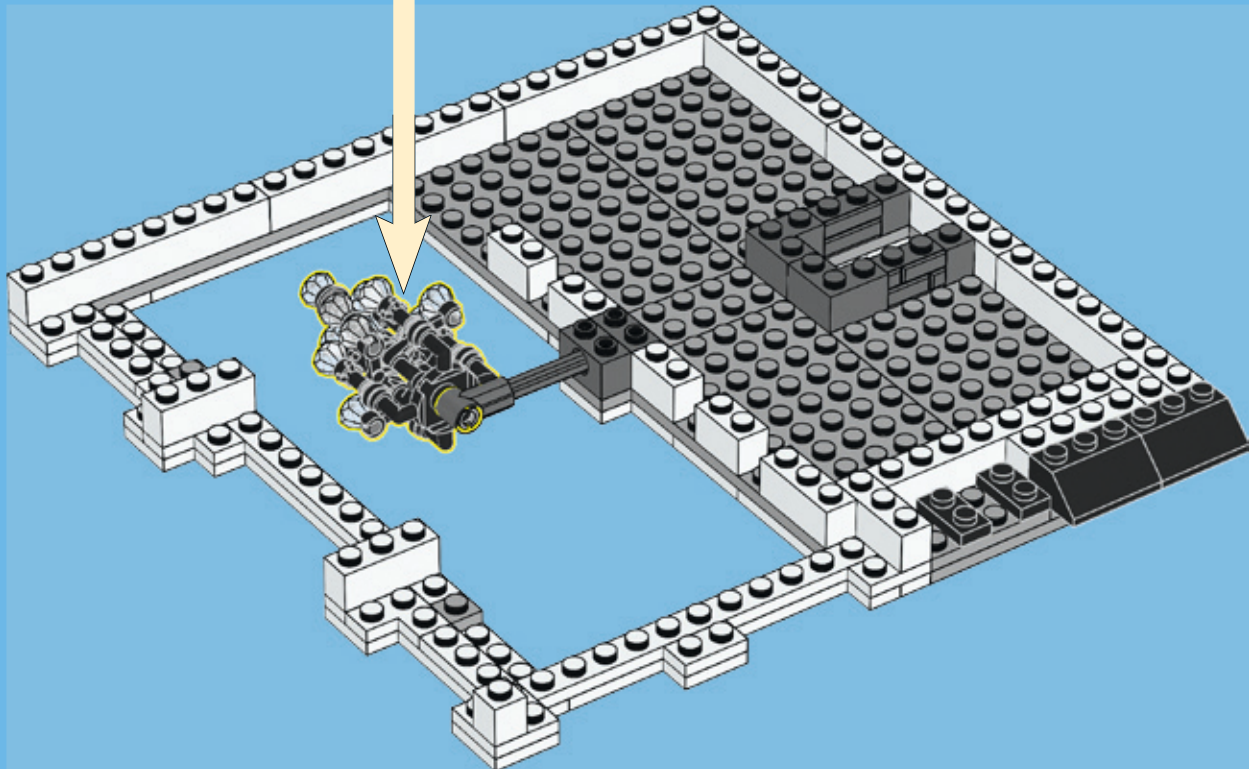

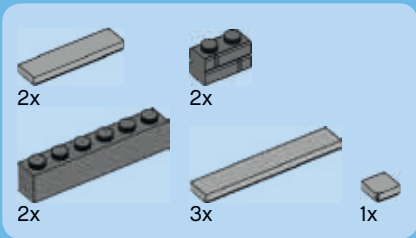

214

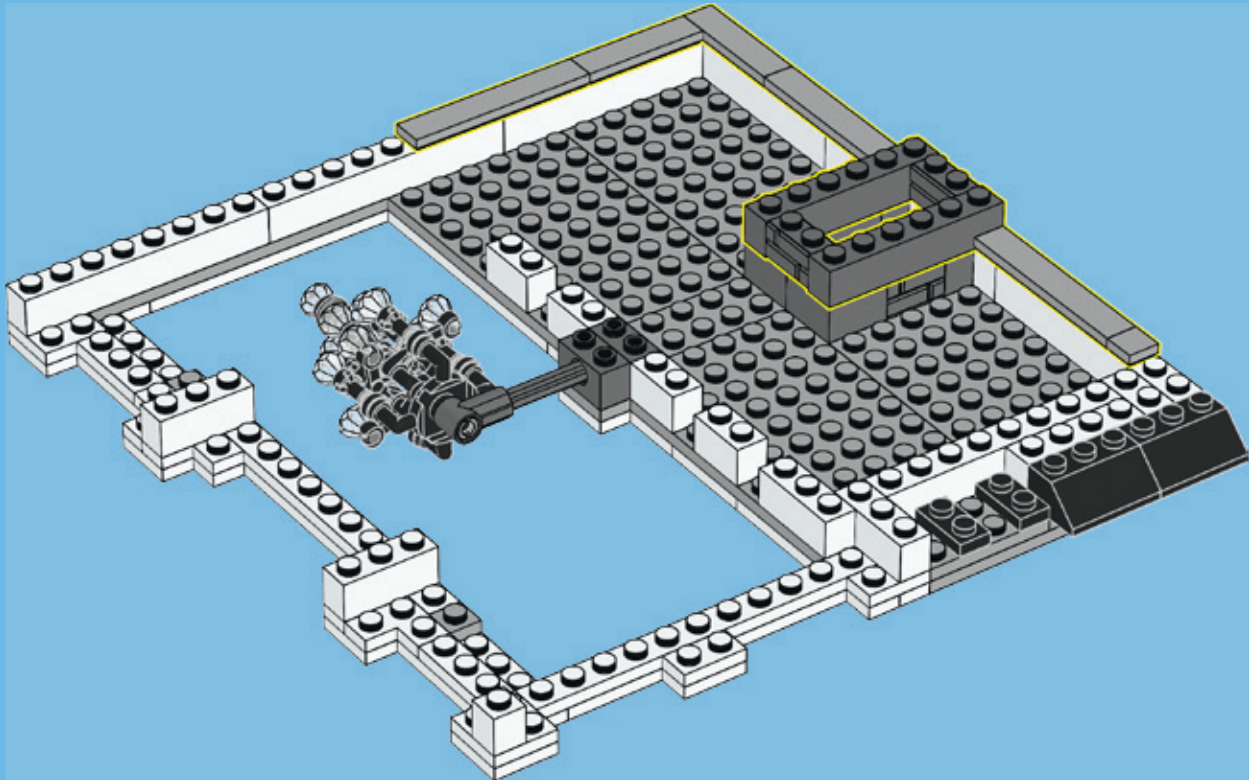

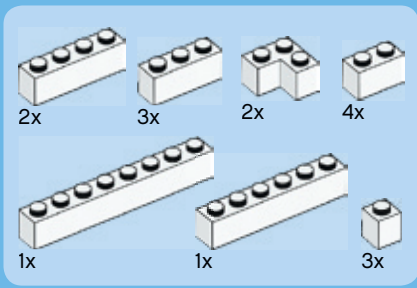

215

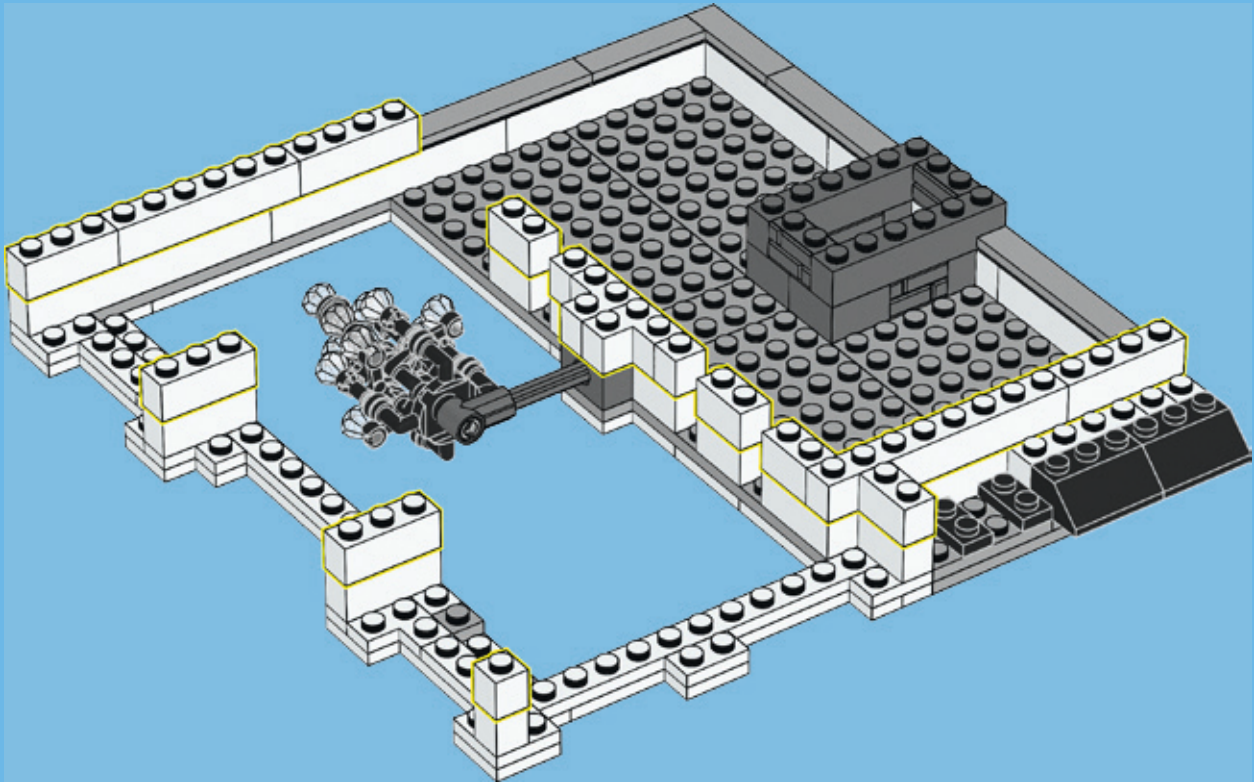

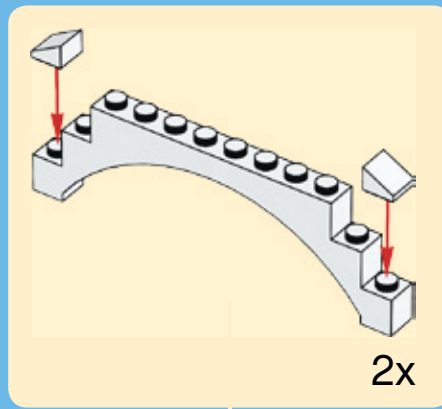
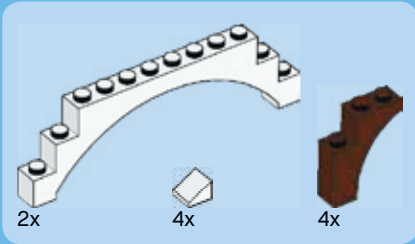

216

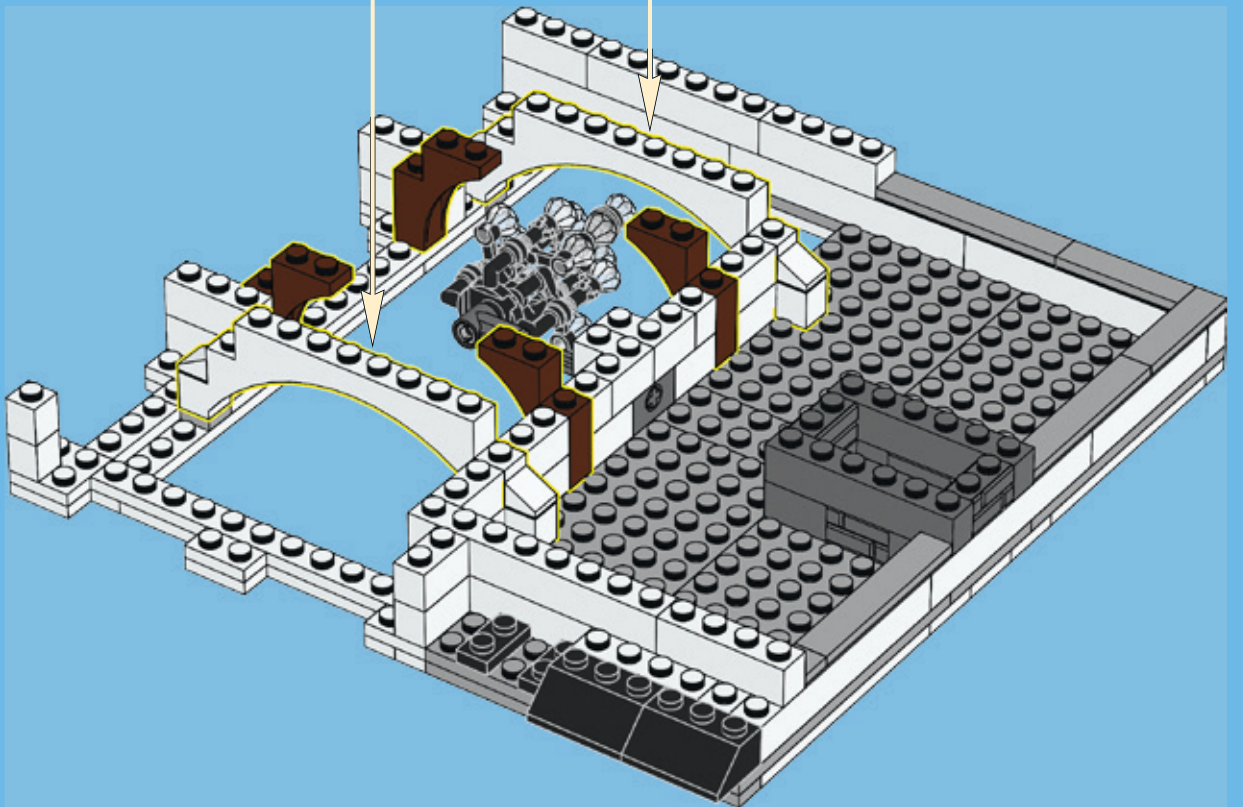



2x



4x



3x



3x



4x



1x

217

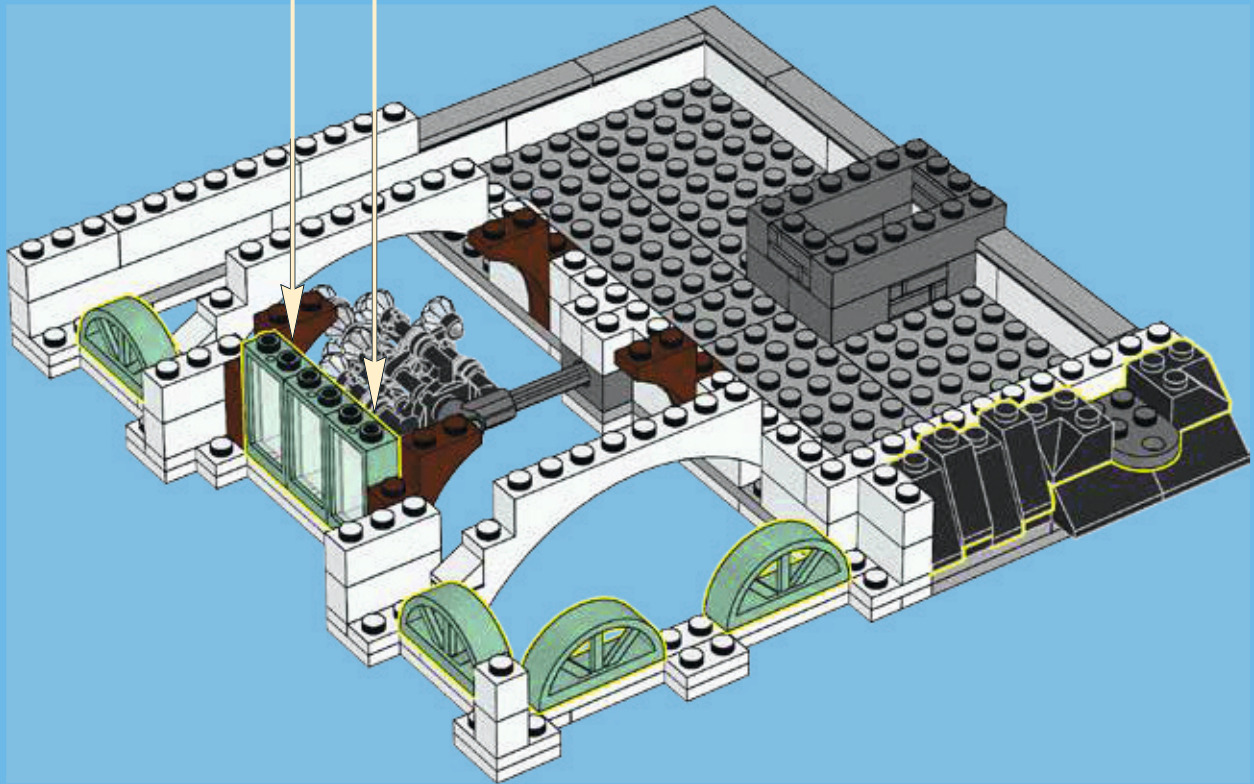
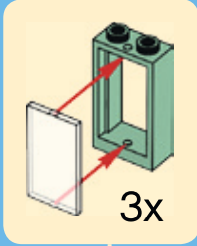

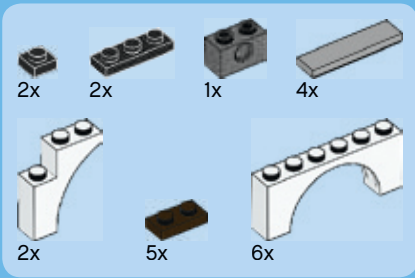

218

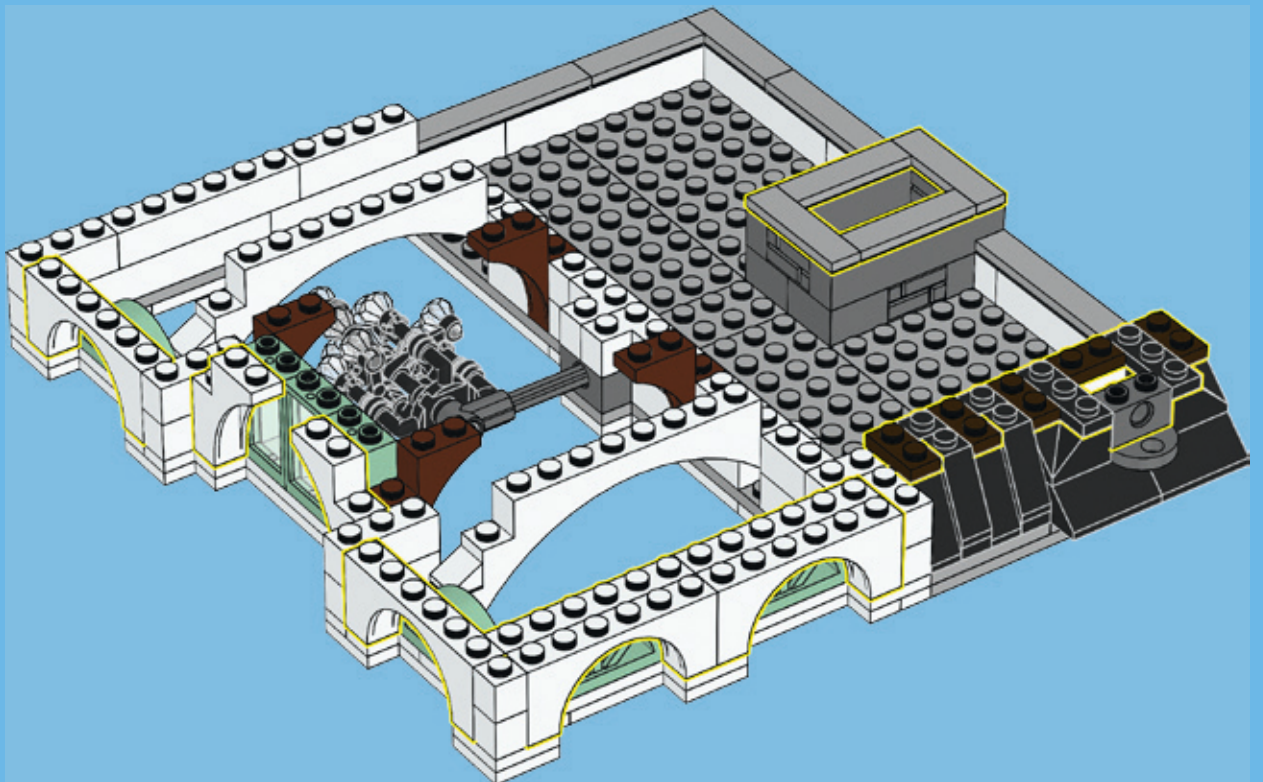

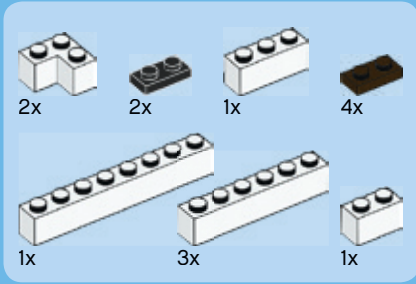

219

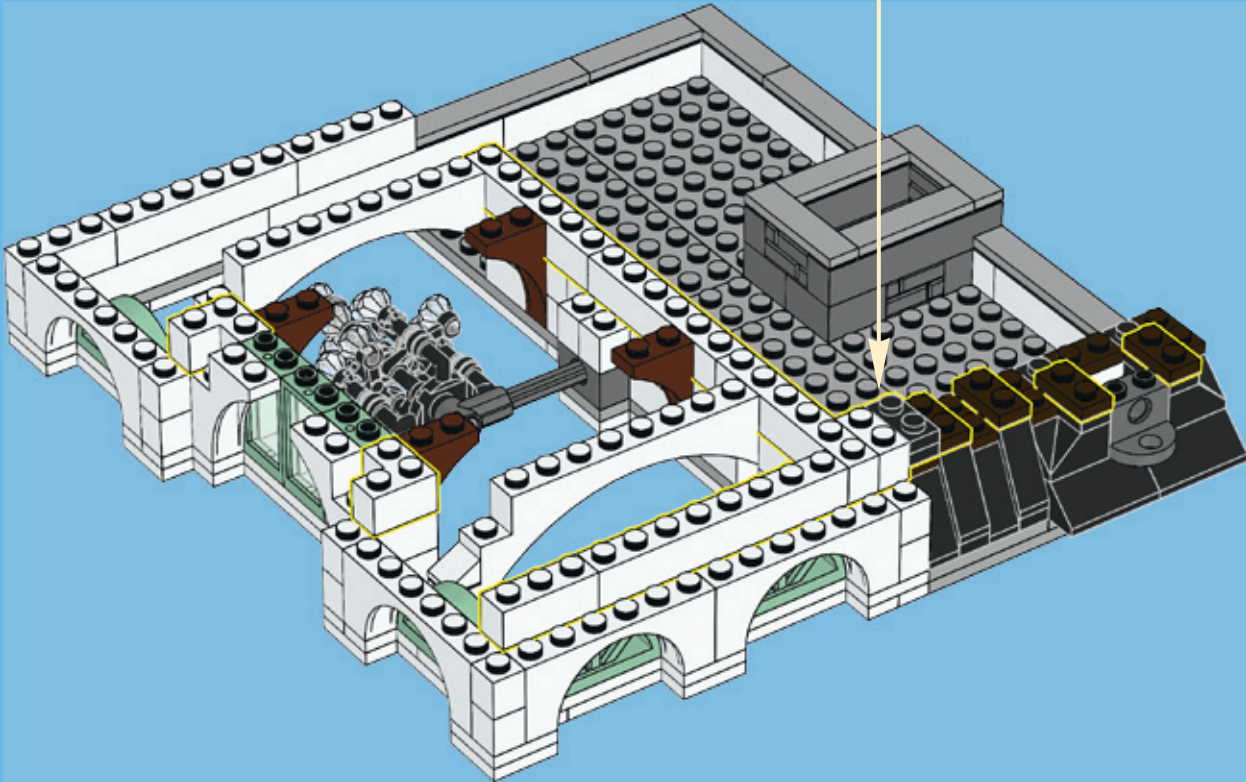
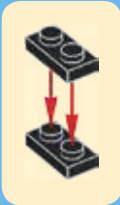

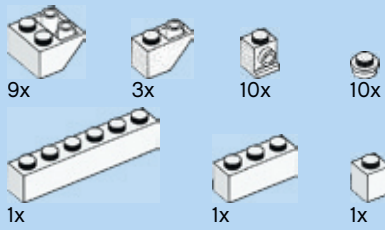

220

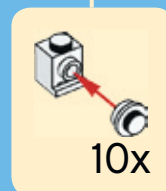
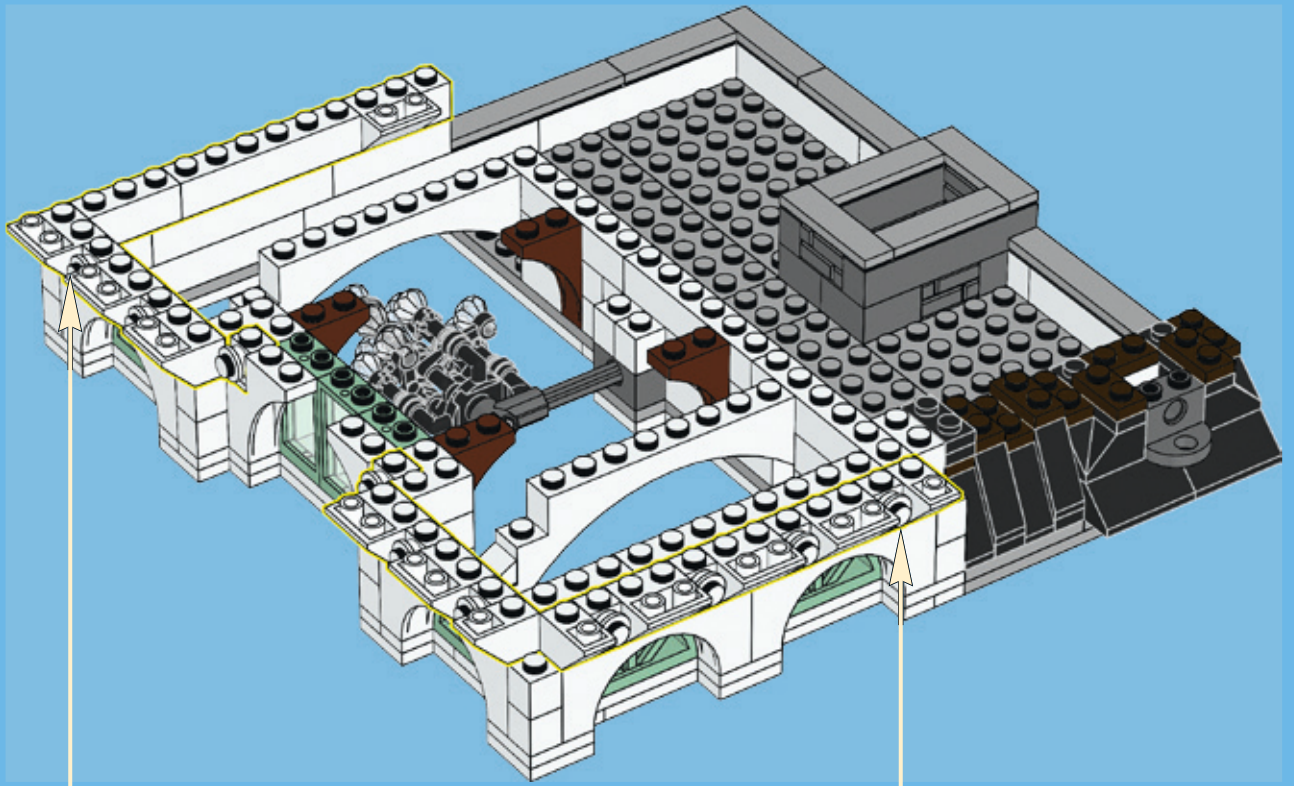

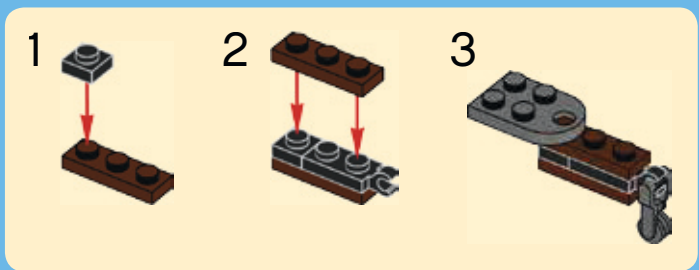

221

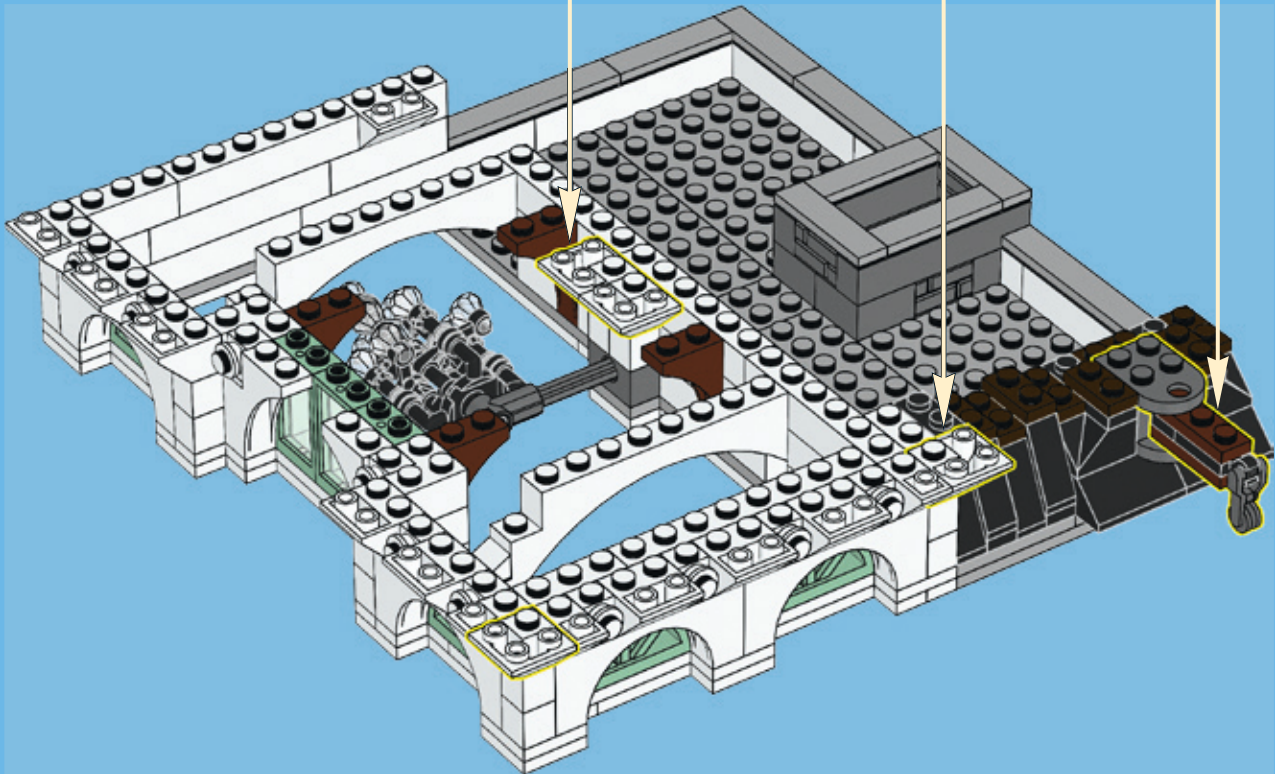
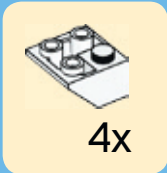



2x



2x



5x

222

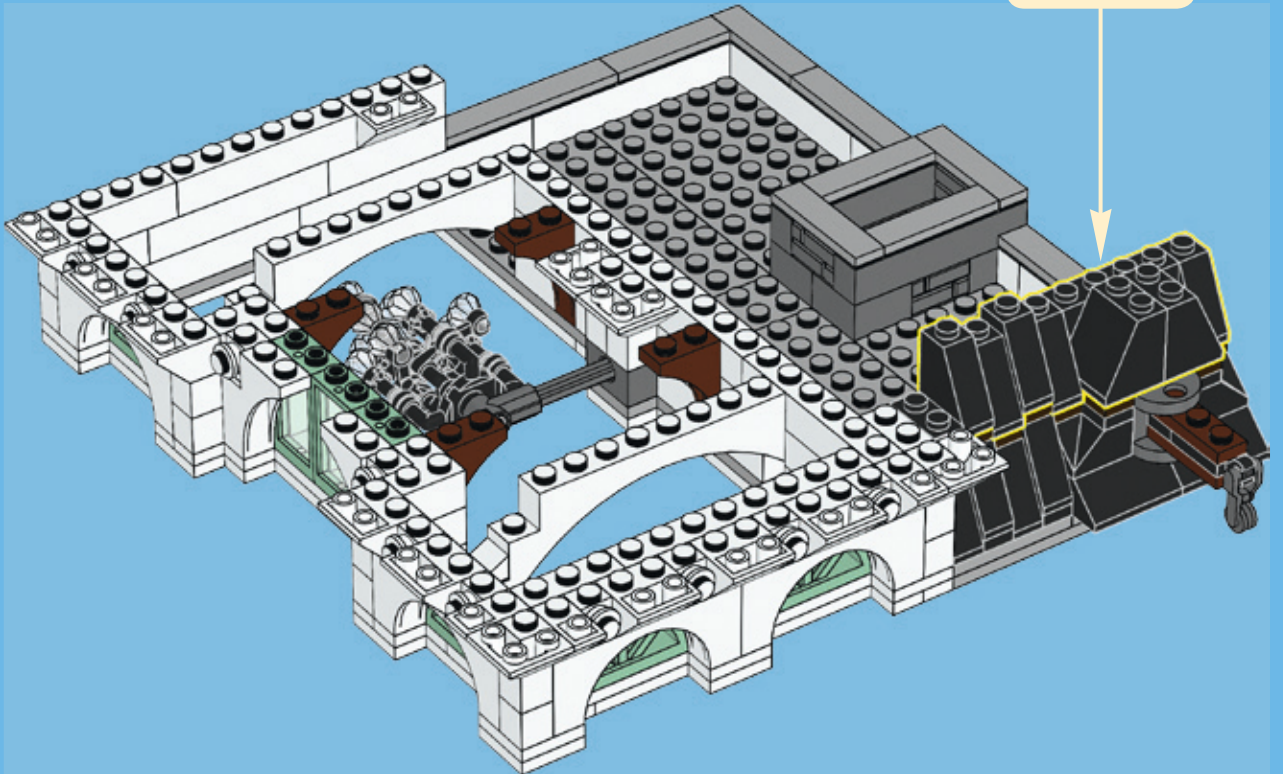
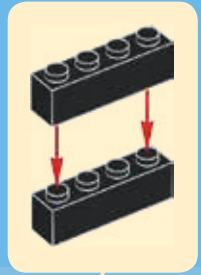

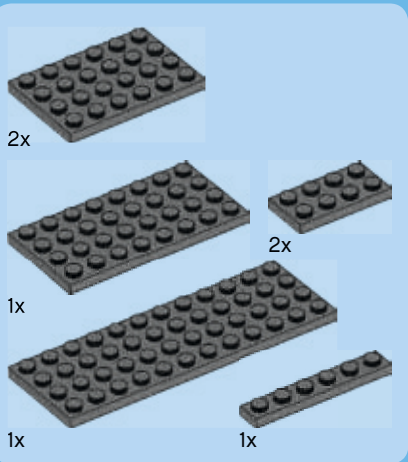

223

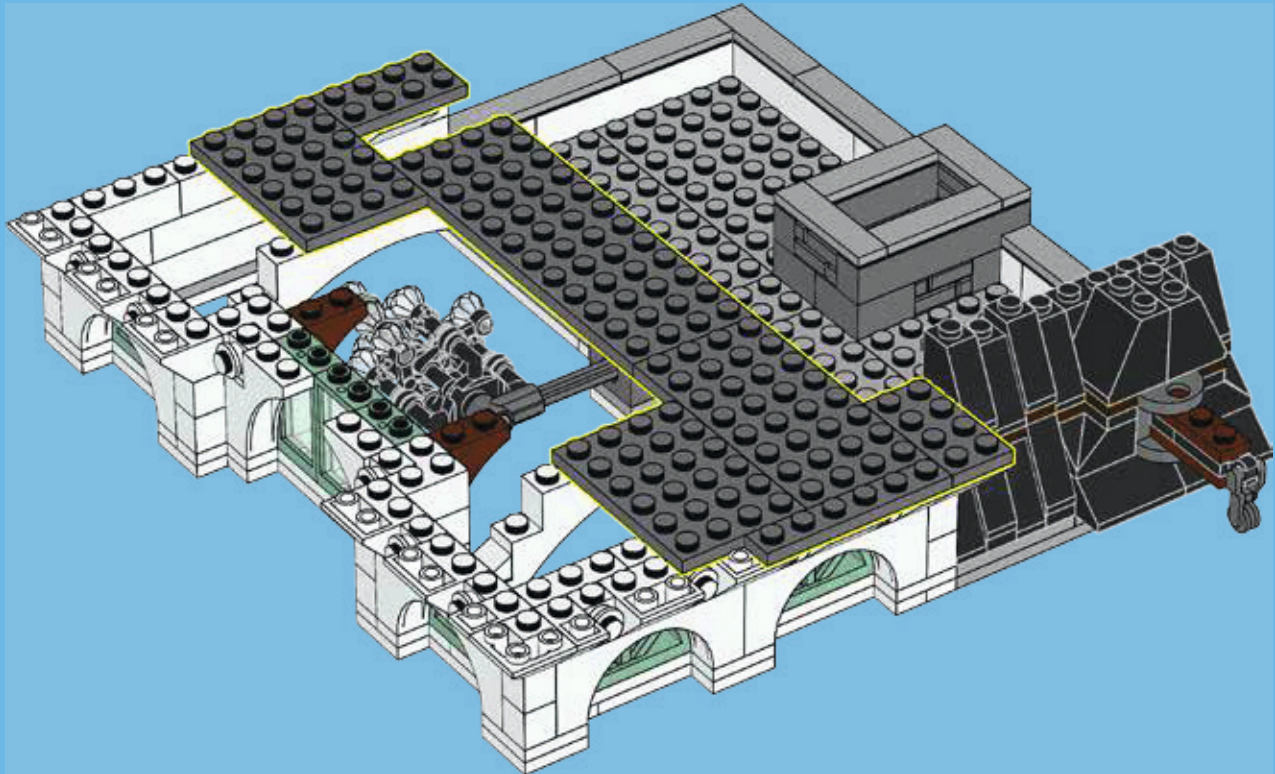

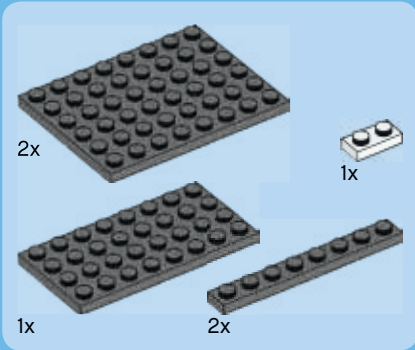

224

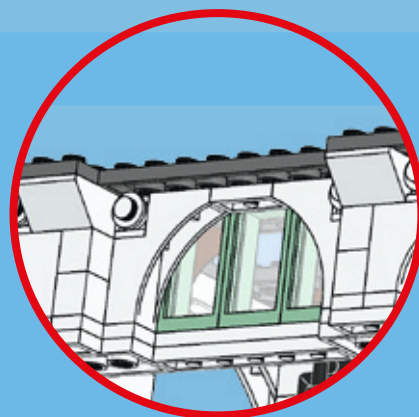
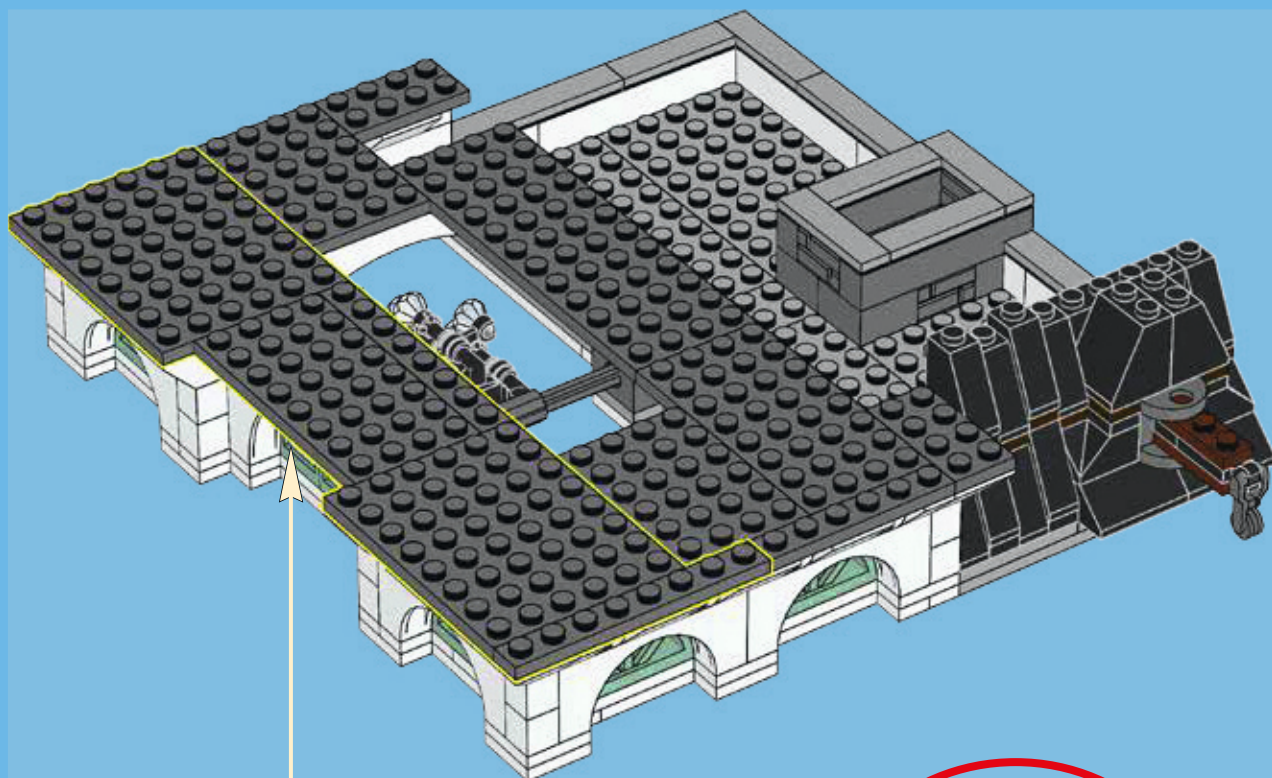

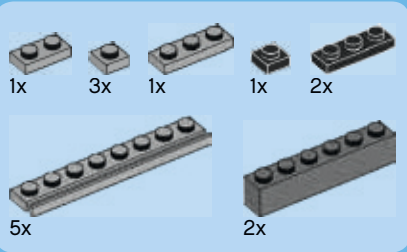

225

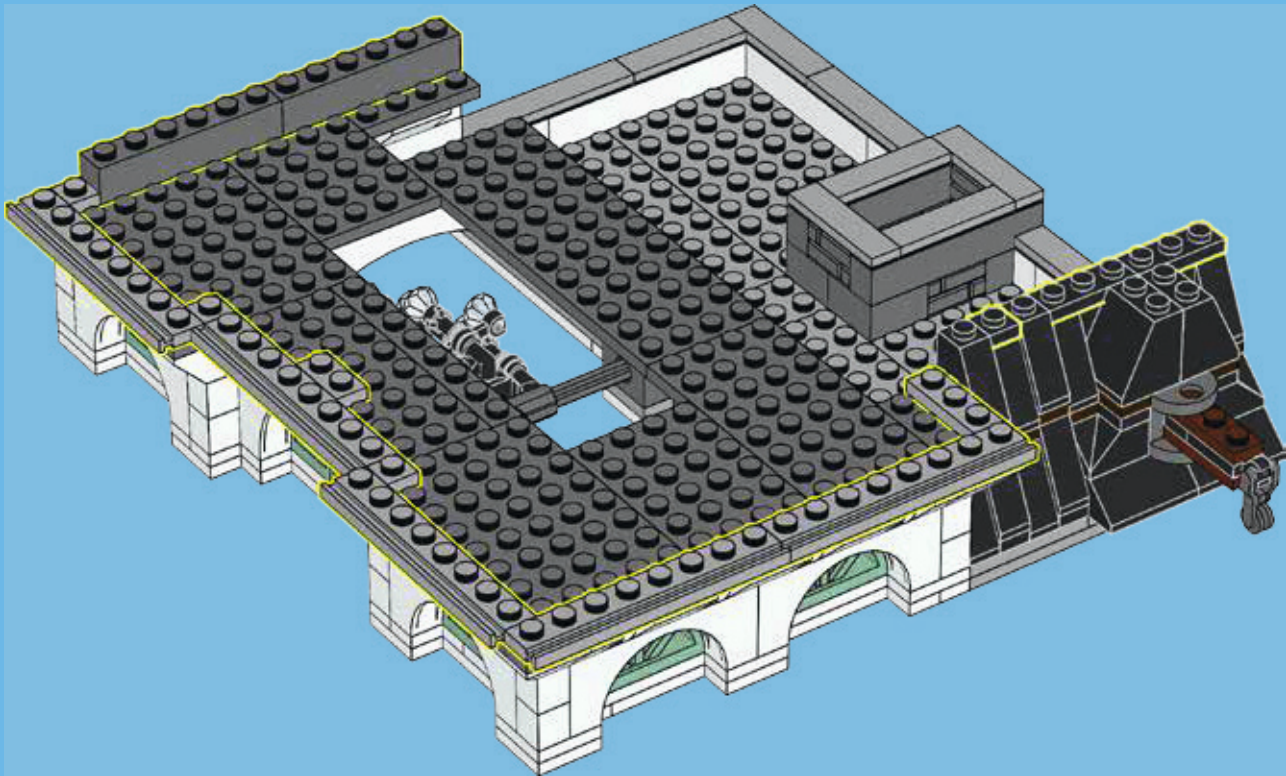

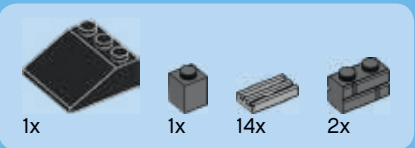

226

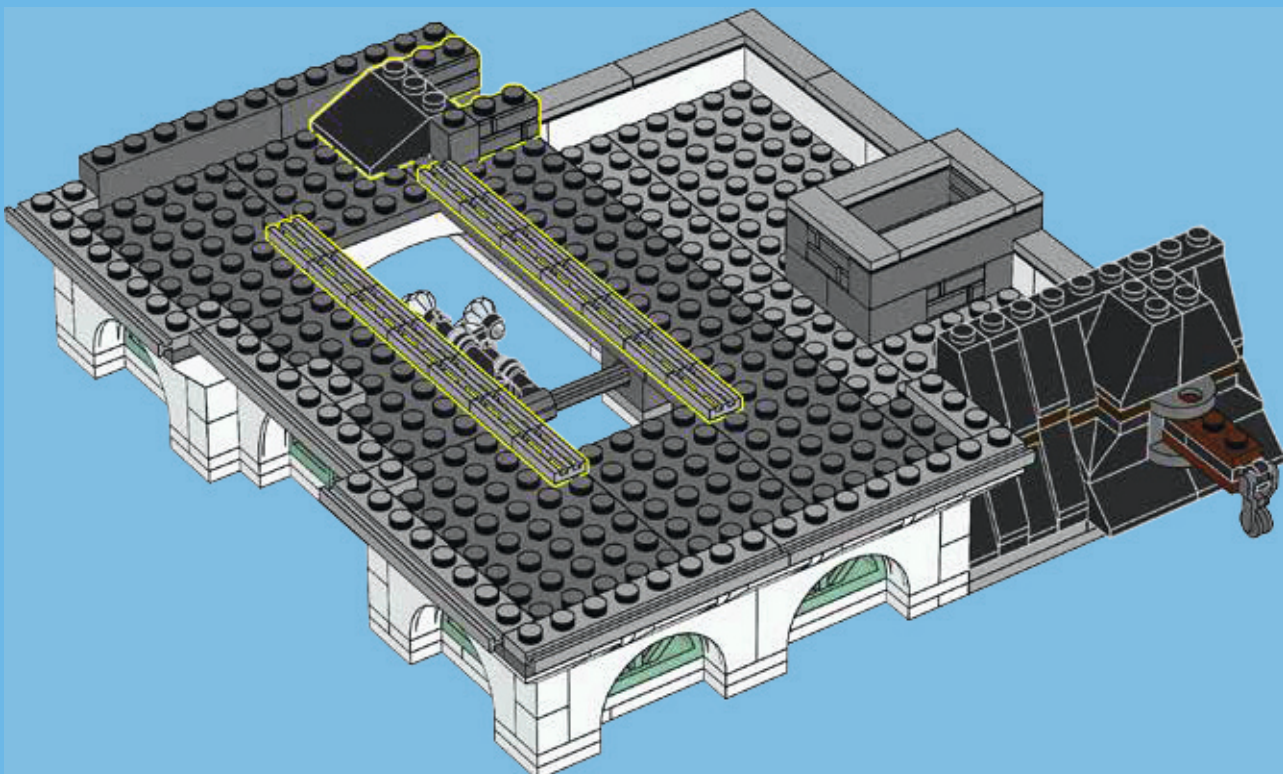



3x



3x

231

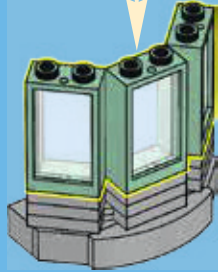
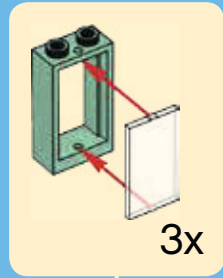

1x



1x

232

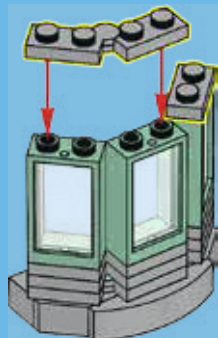

3x



3x

233

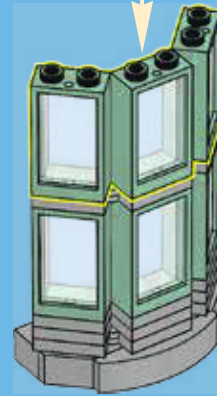
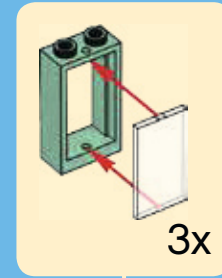

1x



1x

234

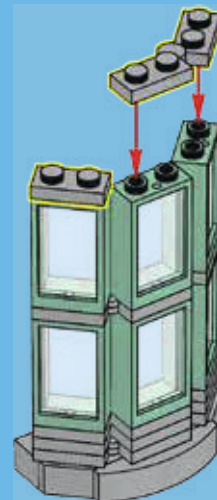



3x



3x

235

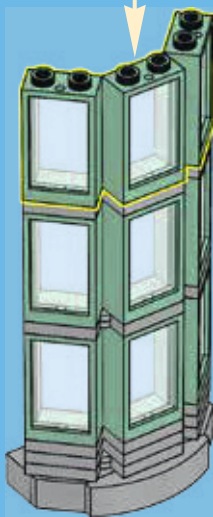
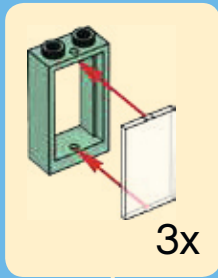

3x



2x



2x

236

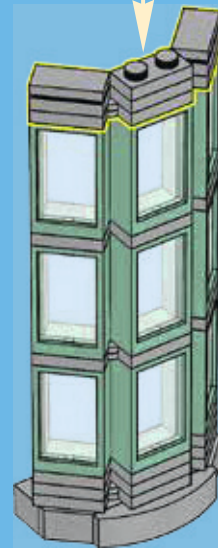
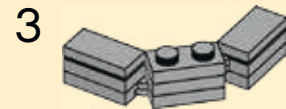
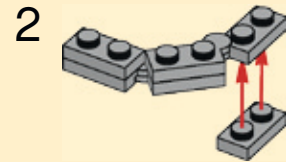
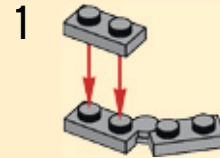

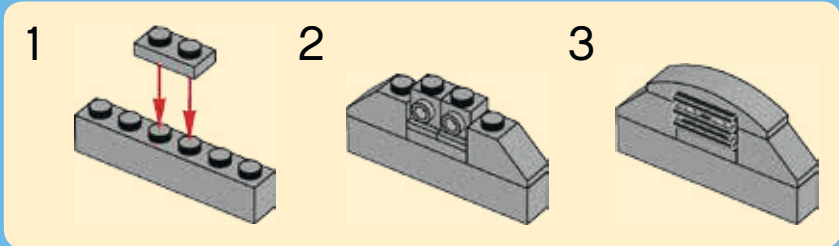
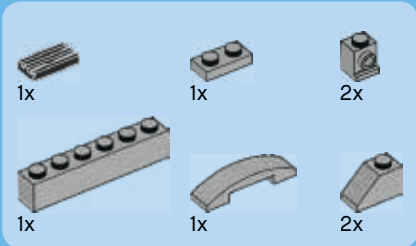

237

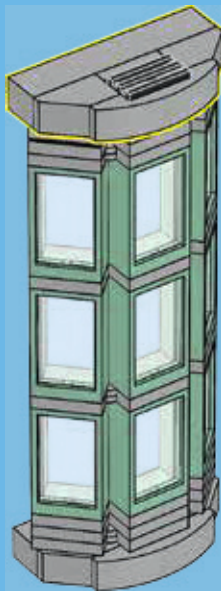

238

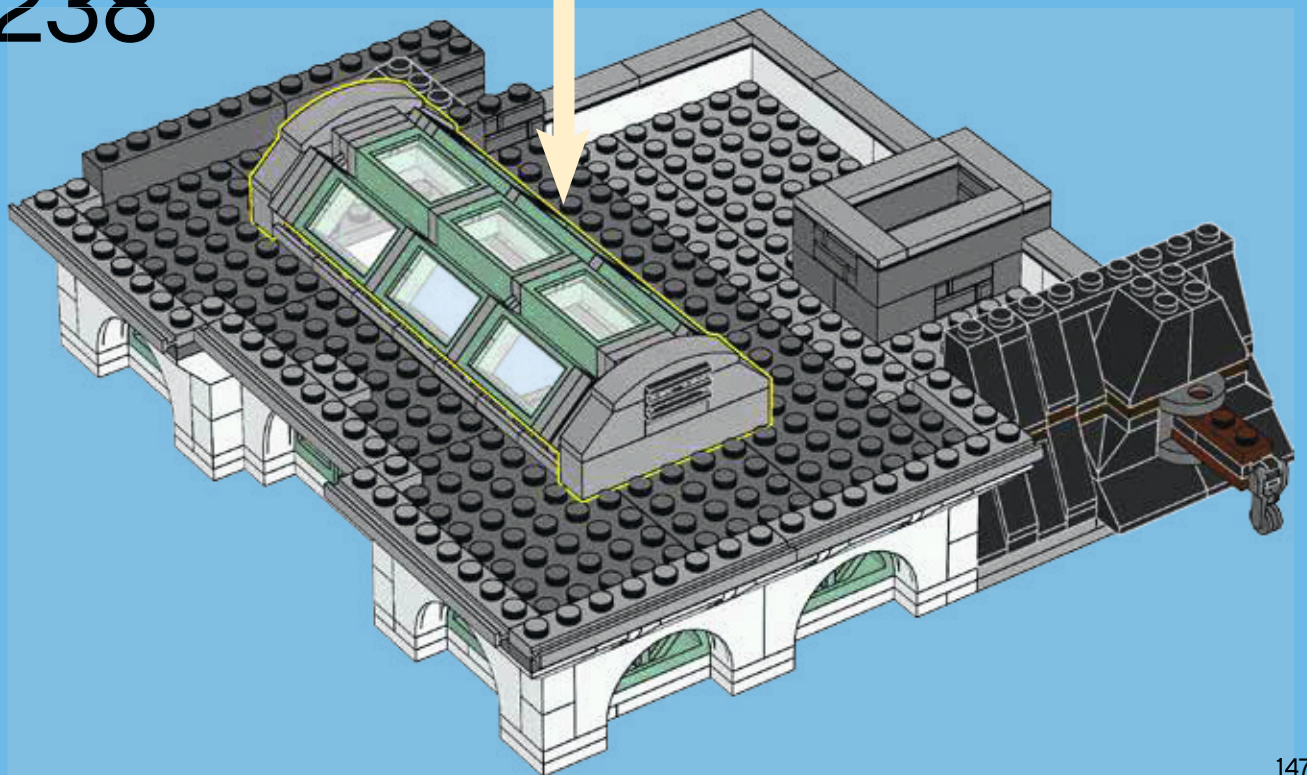

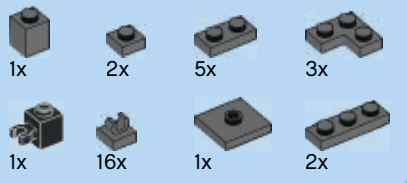

239

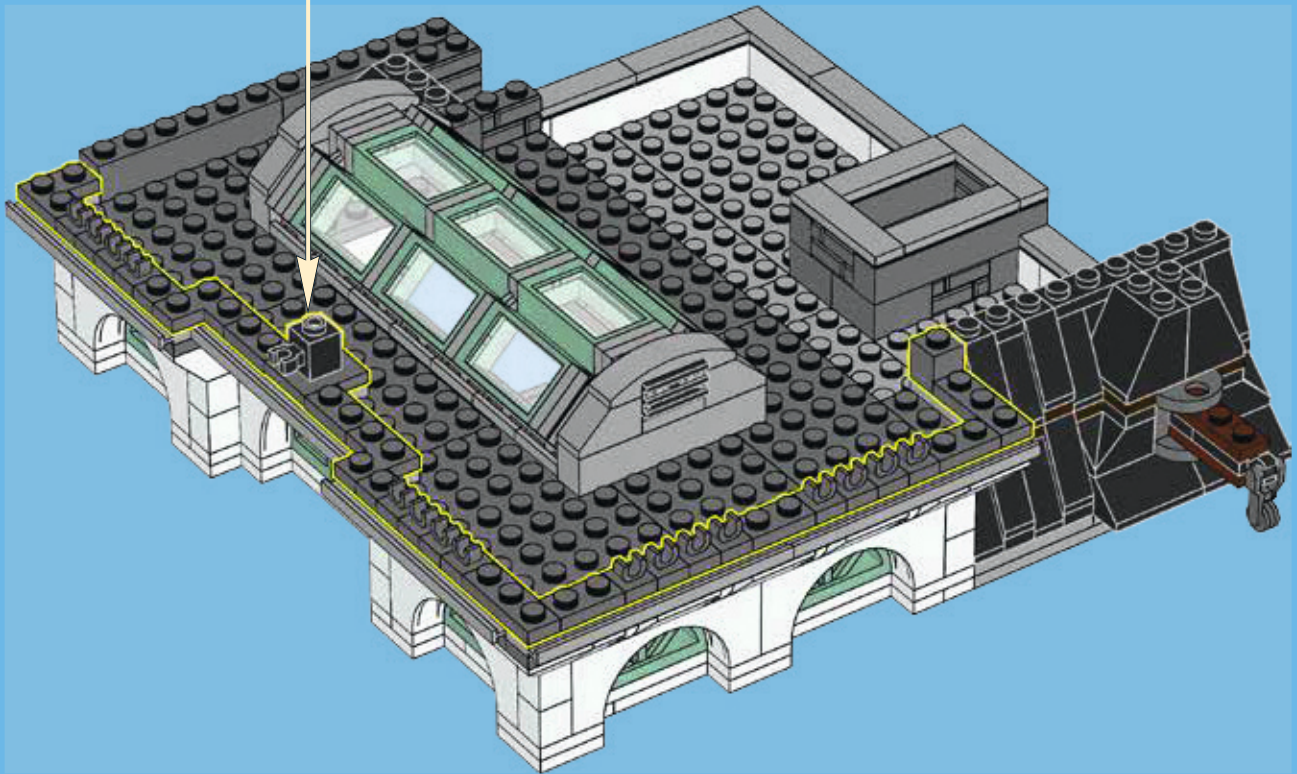

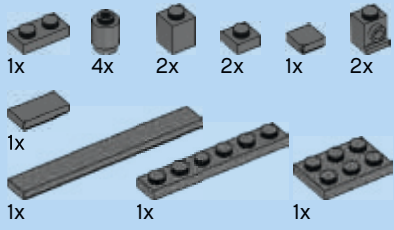

240

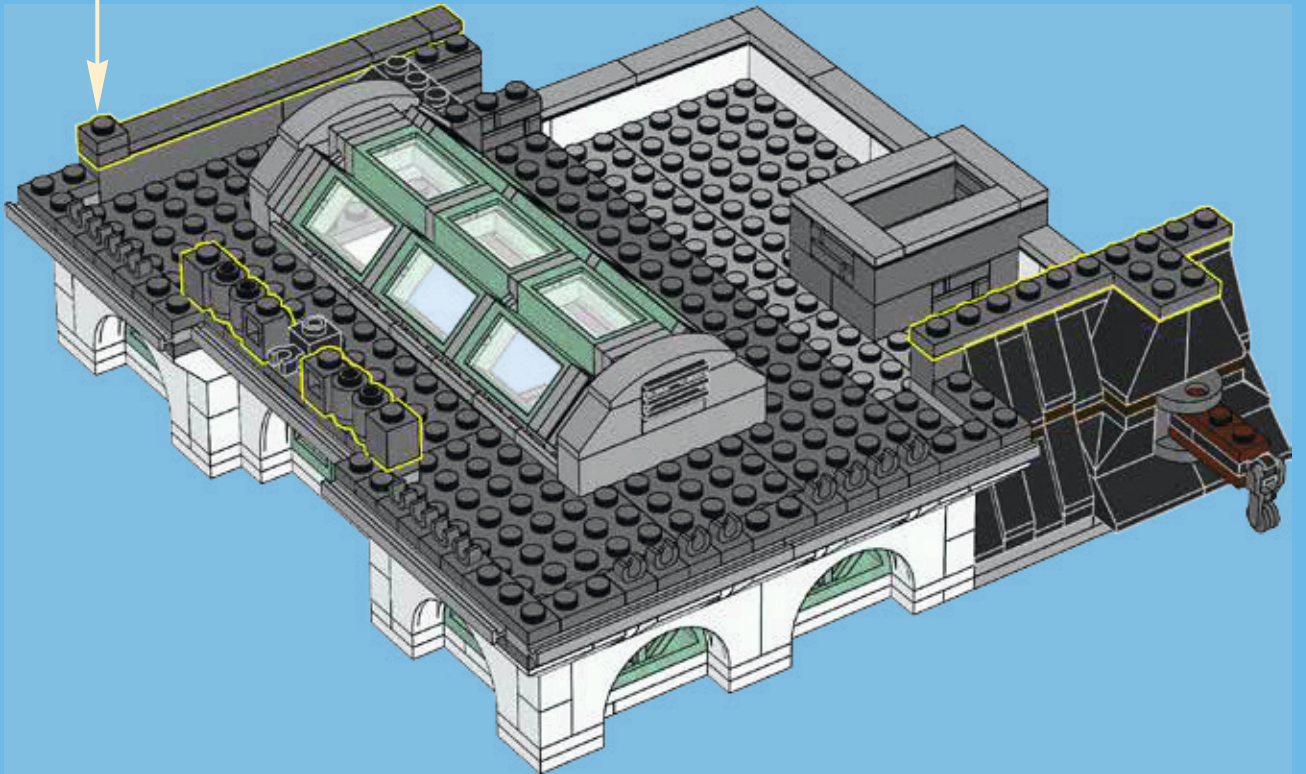
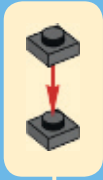



241

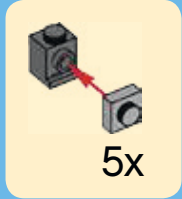
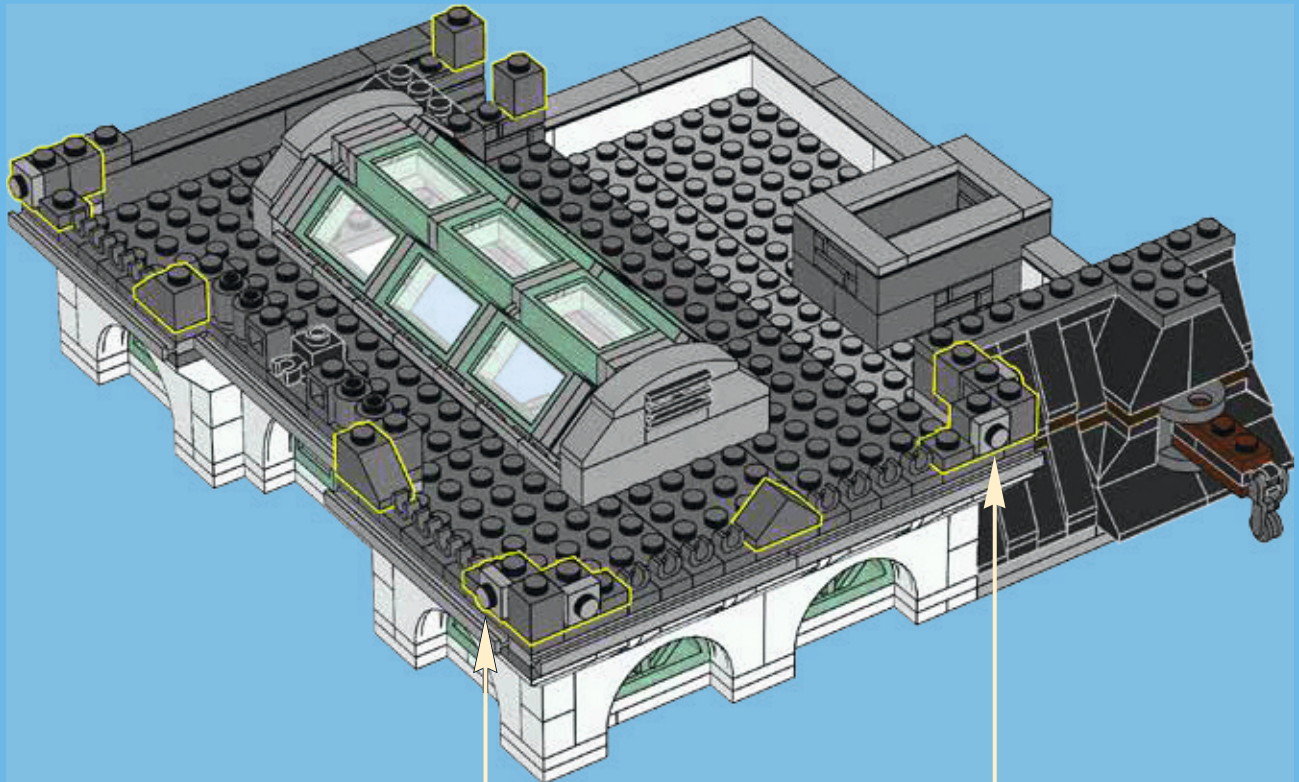



1x



16x



3x



2x



2x



1x



1x

1

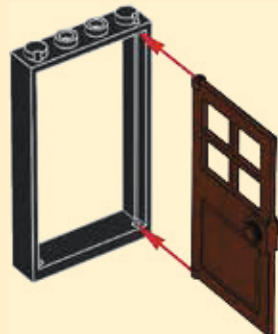

2



242

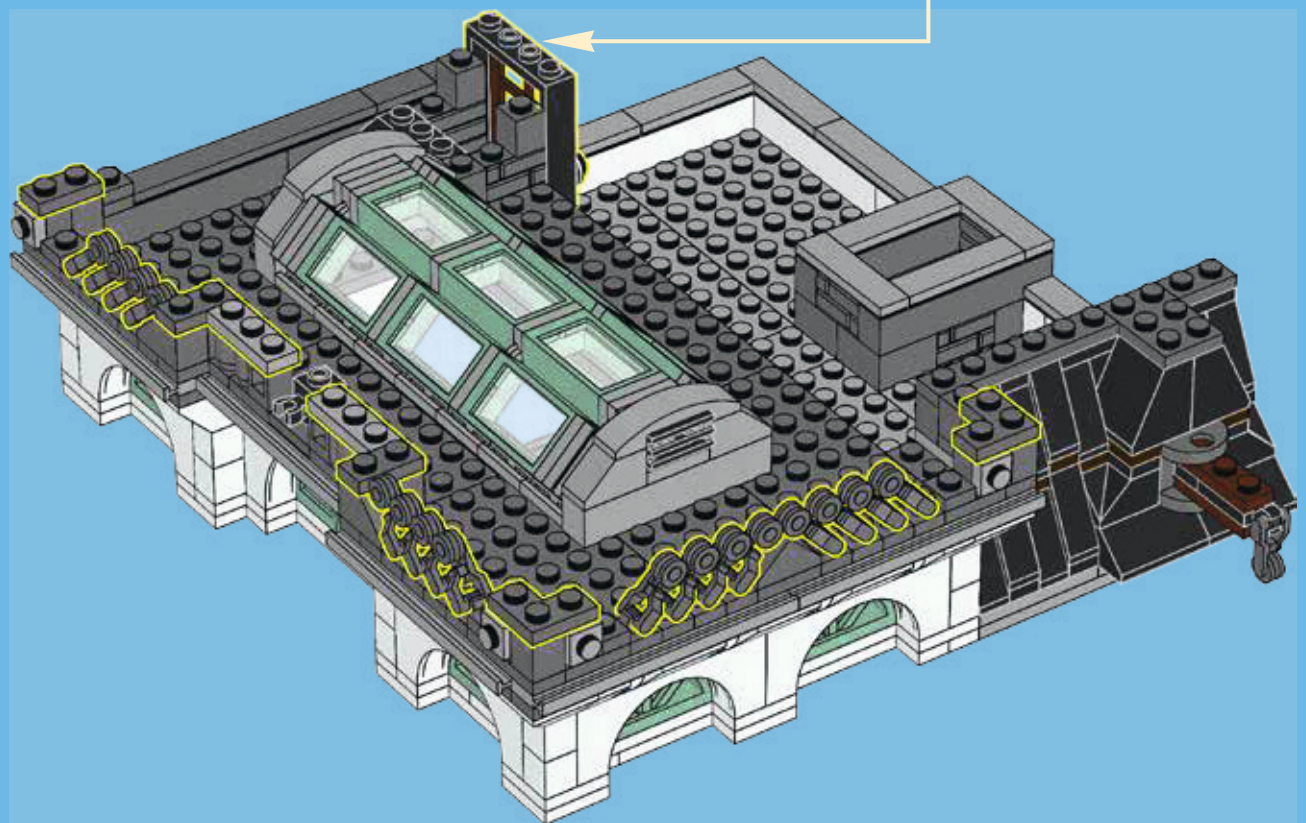

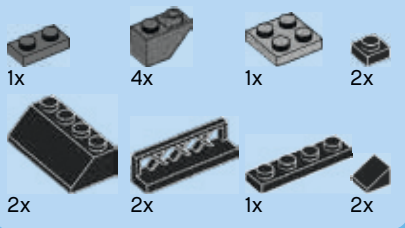

243

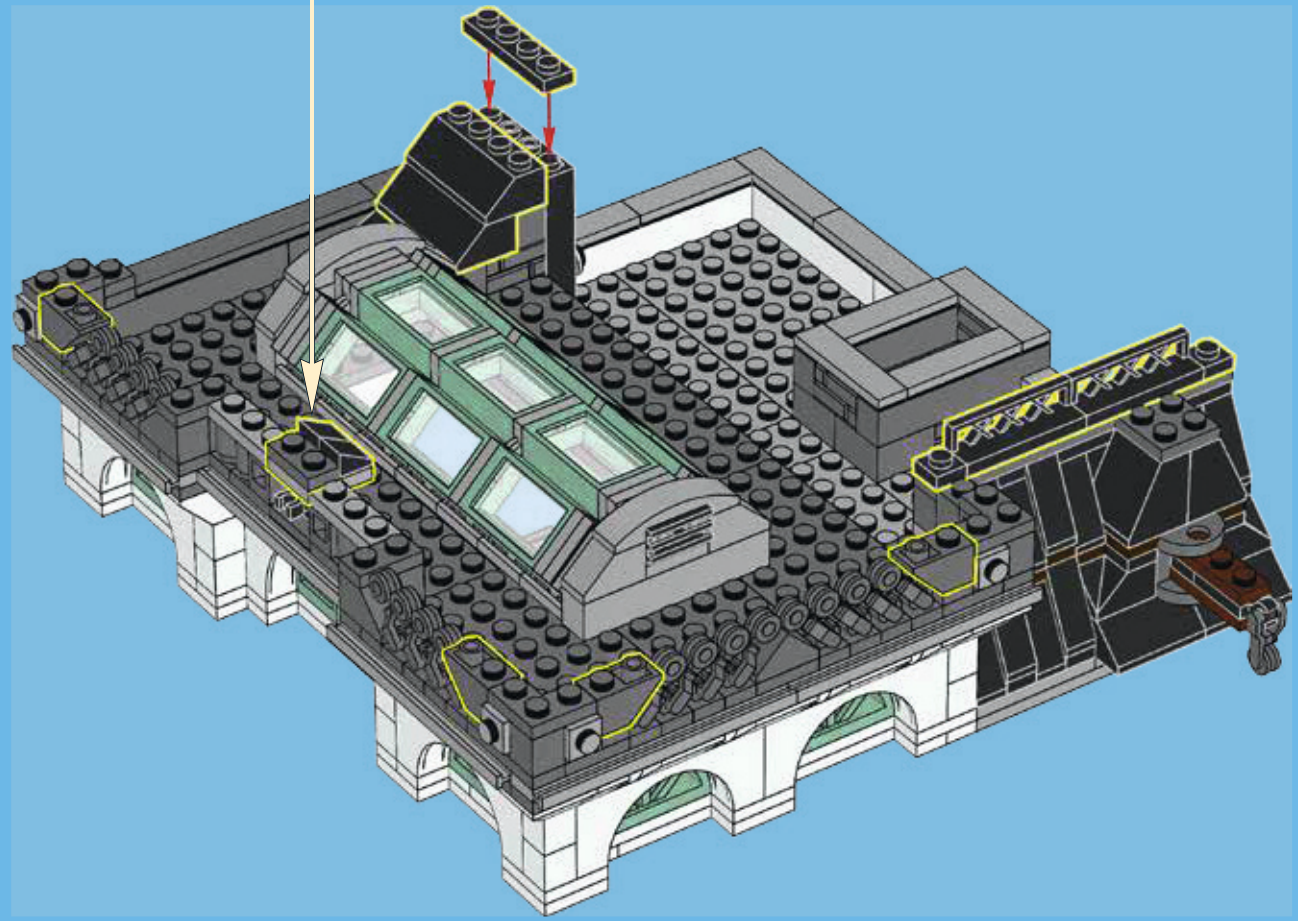
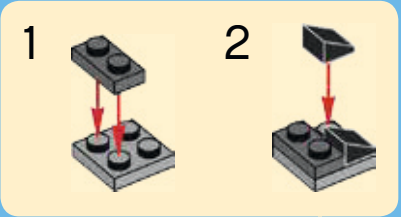

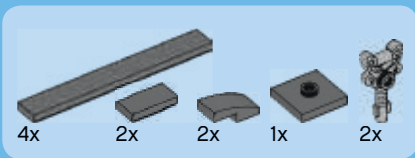

244

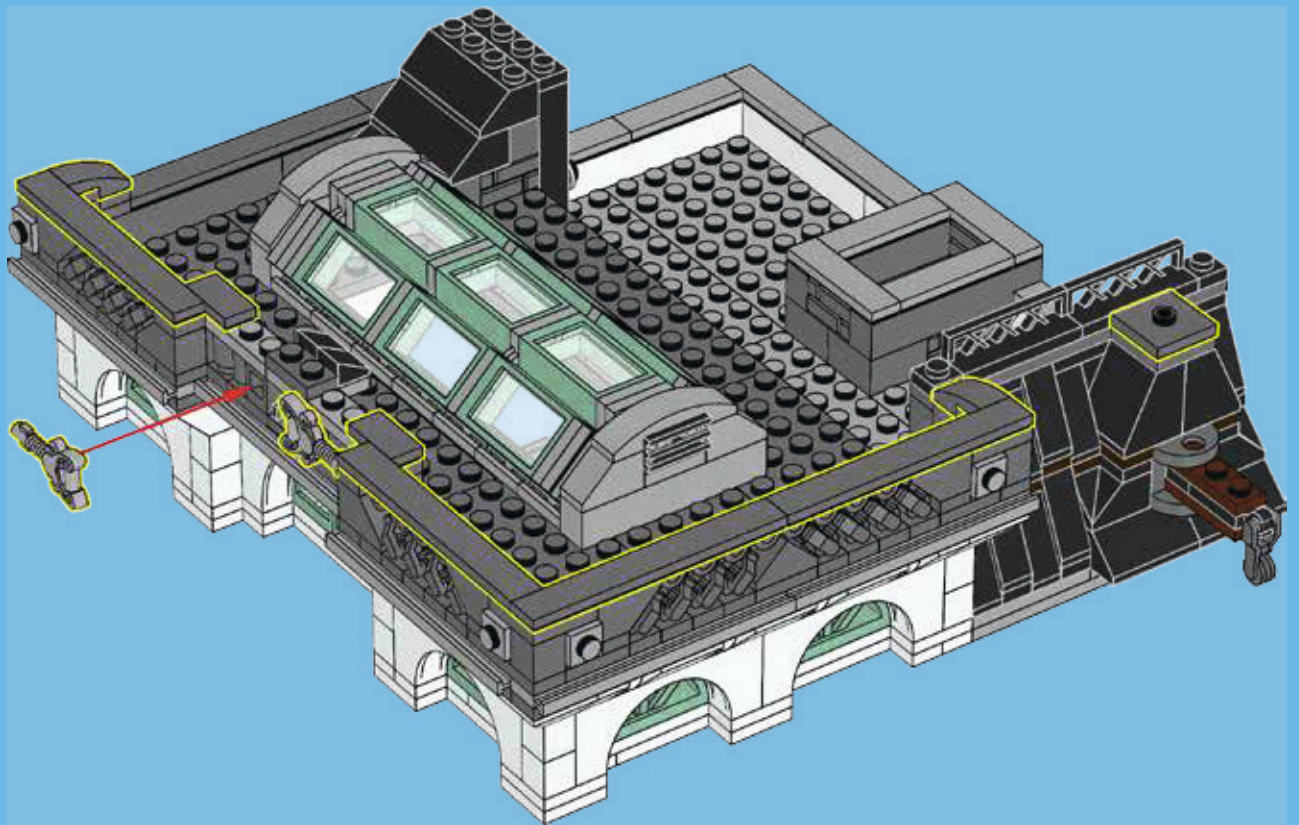



245

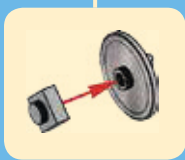
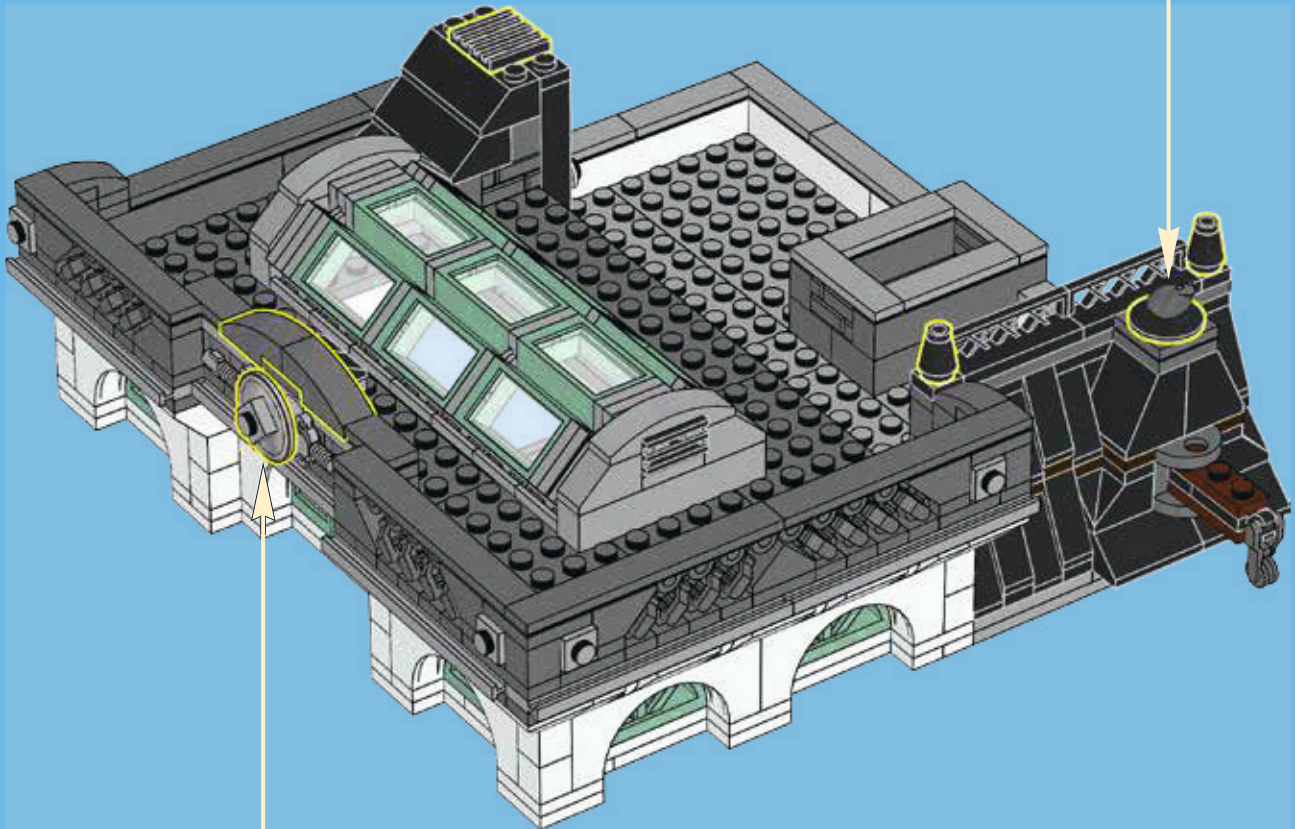

246



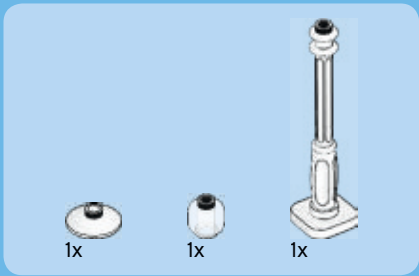

247

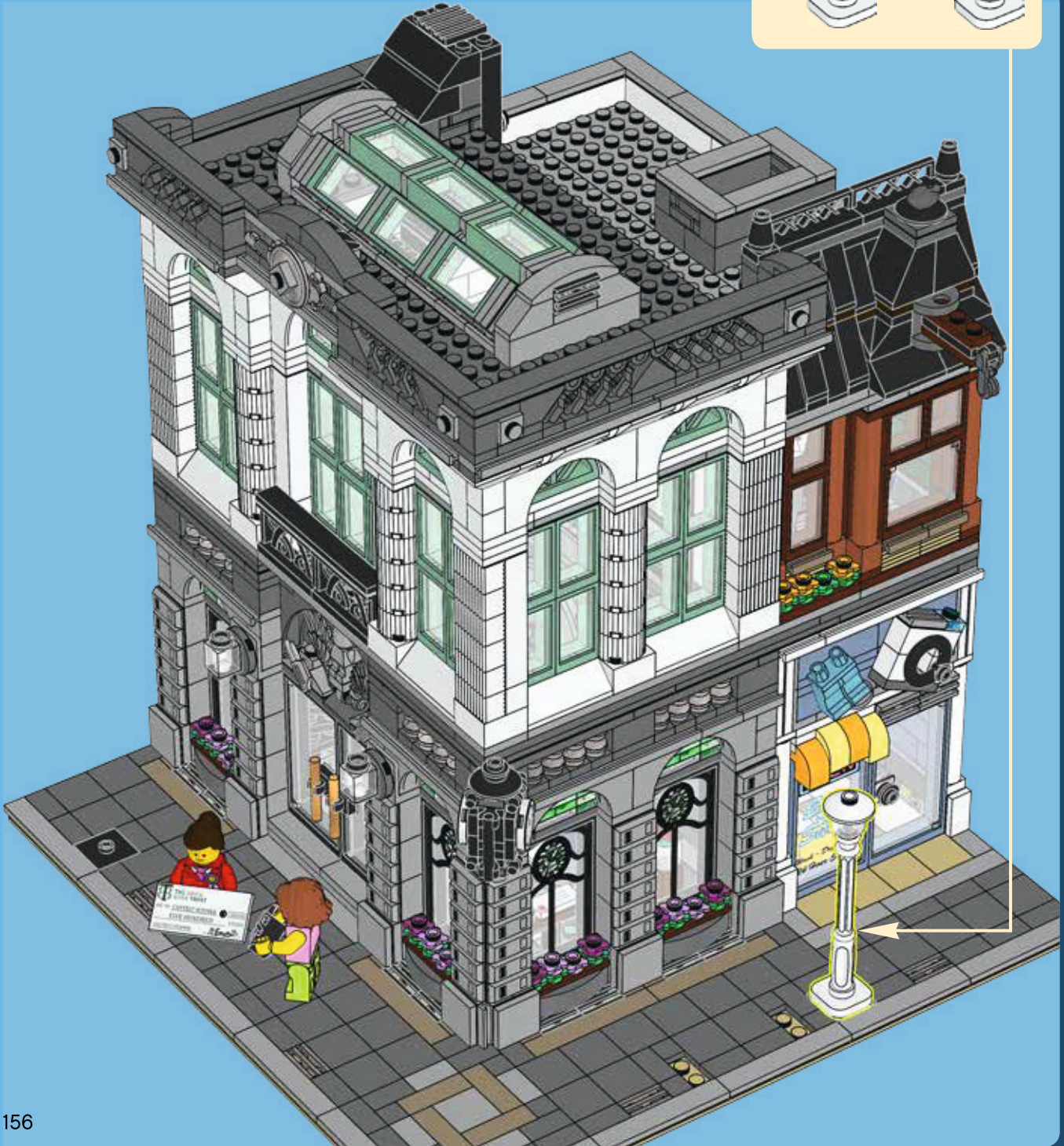
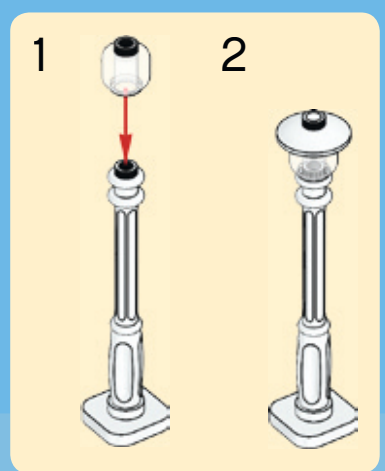



1x



1x

248

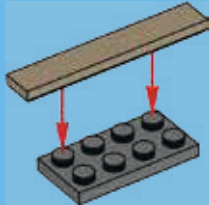

1x



2x

249

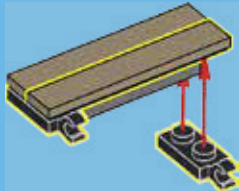

1x



2x

250

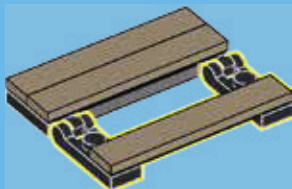

2x



2x

251

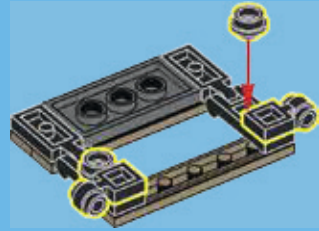

4x

252

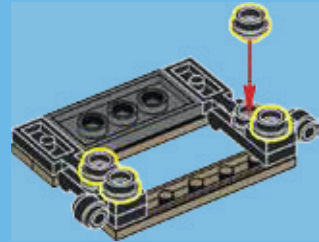

2x

253

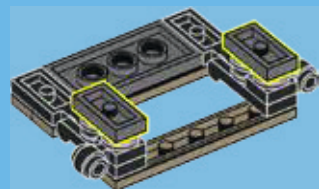



1x

254

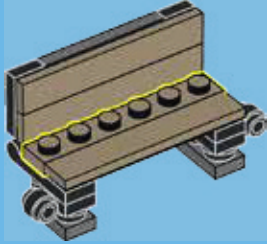

2x

255

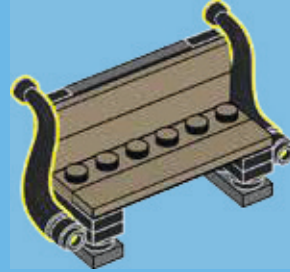

256





257



258



259



260





3x



3x



3x

261

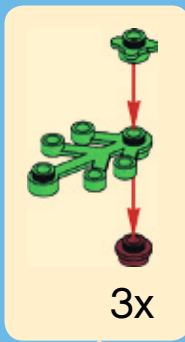

3x

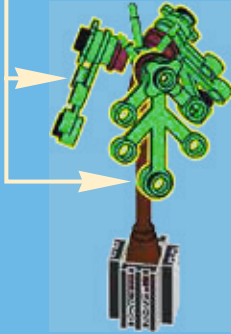

3x

262

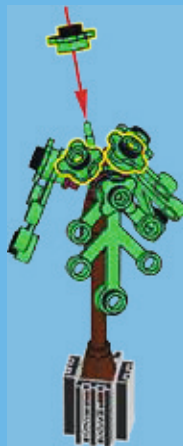

263





264



265



1x

1x

1x

1x

266



267



11x 614101
 1x 6037277
 1x 6139343
 2x 6073345
 10x 407001
 6x 4504369
 8x 4558952
 2x 245301
 2x 307001
 10x 302401
 10x 300501
 4x 6052201
 1x 474001
 18x 4650644
 18x 287701
 5x 366501
 9x 302301
 2x 6051511
 16x 300401
 1x 4119410

2x 4521848
 20x 306901
 4x 245401
 1x 6014274
 1x 4249563
 1x 6123040
 12x 242001
 10x 306801
 5x 302201
 3x 300301
 9x 366001
 12x 235701
 5x 6058329
 4x 6138740
 5x 4520970
 5x 362301
 14x 362201

2x 6038525
 1x 4143254
 7x 301001
 4x 371001
 4x 303701
 2x 302001
 2x 4560178
 1x 6142944
 5x 366601
 6x 6106183
 20x 300901
 20x 300801
 4x 4205107
 2x 4578107
 4x 4185177
 2x 4514554

6x 346001
 1x 4501853
 4x 303401
 2x 6090084
 3x 4514842
 2x 244501
 4x 4118793
 7x 4125253
 1x 4213568
 1x 6138703
 3x 4655900

1x 614121
 2x 6035617
 1x 6003001
 1x 9342
 1x 6009460
 5x 9336
 1x 407924
 1x 6116640
 1x 6057730
 1x 6155220
 1x 6022406
 1x 6100844

8x 4598897
 2x 4529236
 15x 6100627
 1x 4107085
 2x 4504382
 3x 6066102
 1x 6054856
 6x 4558954
 1x 407026
 9x 302426
 2x 6020192
 1x 473326
 1x 4532220
 1x 4653226

1x 4157108
 2x 6006739
 4x 4550017
 1x 4533771
 1x 4106552
 6x 4548180
 1x 4253815
 3x 474026
 2x 4632571
 4x 4121715
 2x 4598528
 4x 4223247
 3x 306926
 16x 241226
 8x 6092585

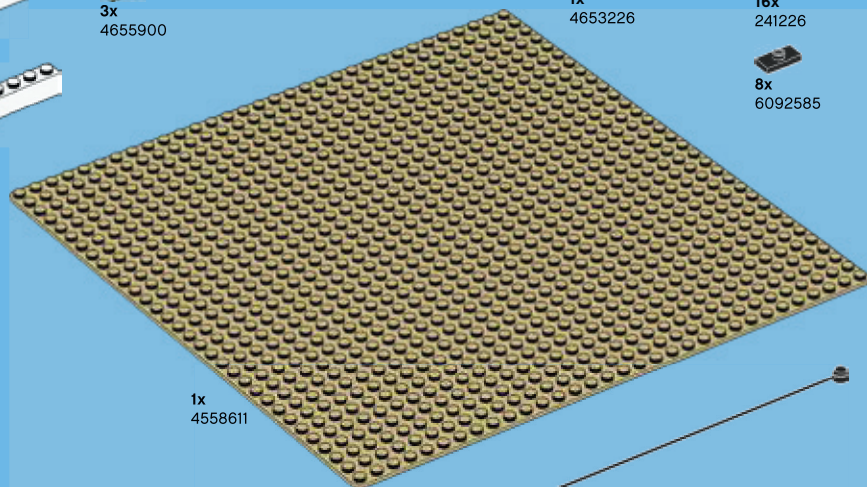

1x 455861

1x 6096957



9x 4515373
1x 4144575
1x 4521439
2x 6132731
9x 302326
1x 6000650
2x 6020193
5x 6097072
2x 4626202
4x 4140588
3x 4535739
2x 6093525
2x 302226
5x 366026
1x 4565323
3x 368026
2x 6053077

2x 4273703
2x 4218890
1x 6132261
2x 6024114
1x 4650145
2x 4515368
2x 362226
4x 362326
4x 4558170
1x 460026
1x 4534267
2x 303826
1x 6099483
1x 370526
2x 301026
1x 4162443

1x 4188953
9x 371026
1x 243126
3x 6066113
2x 6138726
2x 6126103
8x 4535834
2x 4187209
1x 379526
2x 416226
2x 4279270
1x 447726















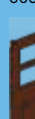

2x 303726
1x 416126
1x 395726
1x 4114689
2x 302026
1x 4560182
23x 6138691
1x 6000071
5x 4107736
7x 4295260
1x 6097232
3x 242328
4x 6030306
1x 6115306
3x 4194746
40x 4217436

13x 4248937
1x 3005740
1x 3001140
16x 3000840
2x 4645394
35x 4536998
3x 6024020
1x 626440
12x 4167842
1x 6142898
4x 6142942
2x 4639698
6x 4521504
1x 4552033

3x 4646864
1x 3000841
1x 4163917
1x 6051918
4x 4266417
1x 6020184
1x 4654448
1x 6069068
1x 6125731
8x 6078932
22x 6055172
1x 4626884
2x 6015449
1x 6101254
2x 6005897
2x 6092591
3x 4530678
4x 4616711
1x 4507045
5x 6073031
1x 4549992

2x 4550168
6x 6015452
1x 6055631
1x 6015424
7x 4507047
3x 6135606
1x 4205004
2x 6103392
2x 6103985
6x 4245570
2x 4538760
7x 4245571
2x 6020923
1x 6071581
4x 4655080
12x 4616578
34x 6138723
4x 6138738

 1x 4649066
 3x 4624184
 2x 6023185
 2x 4529242
 5x 4211242
 2x 4504376
 9x 4225469
 1x 6071274
 3x 4226966
 1x 4211288
 1x 4645400
 6x 4221744
 1x 4211159
 3x 6092590
 3x 4211149
 9x 4211150
 1x 6035547
 2x 6069984
 1x 6058084
 3x 4595814

 1x 6117976
 1x 6075208
 1x 4211257
 1x 6122977
 1x 6142949
 3x 4211152
 4x 6055086
 1x 6103769
 4x 6123759
 1x 6132732
 6x 4211190
 1x 4595889
 1x 4211157
 1x 6081990
 1x 4211204
 3x 4221590
 1x 4211247

 2x 6030812
 3x 4211412
 1x 4640844
 3x 4211573
 1x 4558465
 1x 4211483
 14x 4211476
 6x 4521921
 1x 4558953
 17x 4211399
 1x 4211415
 6x 4211389
 2x 6138743
 4x 4213567
 1x 4211375
 2x 4594238
 3x 4211475
 3x 4540203
 2x 4632575
 1x 4211553
 1x 4227657

 19x 4211350
 1x 6066097
 3x 4211515
 8x 4211388
 51x 4211398
 17x 4211414
 42x 6134378
 1x 4211564
 1x 6015344
 6x 4211614
 24x 6123809
 1x 4228198
 2x 6117967
 4x 4654580
 7x 4211568
 1x 4244627
 2x 6074698
 12x 4211397
 11x 4211413
 1x 4211349

 19x 6065824
 1x 4211753
 1x 6008311
 4x 6138695
 19x 4211429
 1x 4211428
 6x 4558169
 2x 4610149
 29x 4211356
 28x 4211445
 3x 4599498
 2x 4622803
 1x 4211435
 6x 6102769
 4x 4560183
 1x 4211395
 2x 6079461
 3x 4211393

 4x 6106189
 25x 4211549
 21x 4211438
 2x 6015349
 1x 4211796
 1x 4211452
 4x 4211392
 13x 4211425
 3x 4211404
 8x 4211498
 2x 4251149
 1x 4211407
 1x 4211462
 1x 4211408
 8x 4211405
 1x 4211486

6x 4211090	1x 4567887	2x 4211094	1x 4508553	3x 6008715	2x 6060800
17x 4211081	1x 4222693	23x 4210635	24x 4211100	4x 4560184	18x 4523159
1x 6061590	8x 4211096	52x 4211055	8x 4211056	3x 4211065	1x 4529247
1x 4210658	6x 6092572	23x 4211109	4x 4210651	1x 6126113	1x 6039771
28x 4211098	1x 4493478	1x 4618881	1x 4211002	2x 6075060	4x 6112307
23x 4210719	3x 4211111	13x 4211133	11x 4211008	8x 6062686	4x 4538126
20x 6071226	20x 6069164	15x 4211104	8x 4210998	15x 4620077	2x 6093529
7x 4211044	57x 4211052	2x 4246896	18x 4210999	21x 4620991	1x 4587274
19x 4210848	14x 6000311	2x 4225733	2x 4211099	3x 6057880	1x 6093516
10x 4210639	19x 4211088	1x 6086709	2x 4211115	4x 6139341	9x 6058221
1x 4272368	1x 4210797	4x 4211043	2x 4210997	1x 6082516	2x 6126118
1x 6020189	35x 4211063	2x 4211106	2x 421061	26x 4620993	16x 6058160
2x 4587212	2x 6029948	1x 4211053	2x 4210794	4x 6111685	16x 4633691
2x 6055313	2x 4211135	17x 4211103	2x 6133611	3x 6138708	2x 6078241
1x 4226221	4x 6000606	13x 4211001	2x 4211067	2x 4636105	1x 6030333
	2x 4543086	4x 4648256	1x 4210706	1x 6076677	2x 4636105
	2x 4565322	8x 4598769	2x 4210796	1x 6104570	1x 6029933
			4x 6051422	8x 6074906	



Customer Service
Kundenservice
Service Consommateurs
Servicio Al Consumidor
LEGO.com/service or dial

00800 5346 5555 :

1-800-422-5346 :



CREATOR

10251

10246

10243



EXPERT

[LEGO.com/creator](https://www.lego.com/creator)



CREATOR



LEGO.com/creator



Apple, the Apple logo, iPad, iPhone and iPod touch are trademarks of Apple Inc. Apple, le logo Apple, iPad, iPhone et iPod touch sont des marques de commerce d'Apple Inc. Apple, el logotipo de Apple, iPad, iPhone e iPod touch son marcas comerciales de Apple Inc. Google Play is a trademark of Google Inc. Google Play est une marque de commerce de Google Inc. Google Play es una marca comercial de Google Inc.



JOIN THE LEGO® VIP LOYALTY PROGRAM! NIMM AM LEGO® VIP-PROGRAMM TEIL! REJOINS LE PROGRAMME DE FIDÉLITÉ LEGO® VIP!

EARN POINTS TOWARDS VALUABLE REWARDS EVERY TIME YOU SHOP!



Get 1 VIP Point for every Dollar, Pound or Euro spent*

*For other exchange rates, please see VIP.LEGO.com



For every 100 Points you earn, enjoy a \$5 / £5 / 5€ reward!

SAMMLE BEI JEDEM EINKAUF PUNKTE FÜR WERTVOLLE PRÄMIEN!



Erhalte 1 VIP-Punkt für jeden Euro, Pfund oder Dollar, den du aus gibst*

*Den Umrechnungsfaktor für andere Währungen erhältst du auf VIP.LEGO.com



Für 100 VIP-Punkte erhältst du eine Prämie von 5 € / £5 / 5\$!

GAGNE DES POINTS À CHAQUE ACHAT ET OBTIENS DE FORMIDABLES RÉCOMPENSES !



Gagne 1 point VIP pour chaque euro, livre ou dollar dépensé !*

*Pour d'autres taux de change, rends-toi sur VIP.LEGO.com



Par tranche de 100 points gagnés, bénéficie d'une récompense de 5 € / 5 £ / 5 \$!

- o Be the first to purchase selected items.
- o Take advantage of bonus or double points.

PLUS MUCH, MUCH MORE!

- o Kaufe ausgewählte Produkte noch vor allen anderen.
- o Profitiere von Bonus- und Doppelten Punkten.

UND VIELES MEHR!

- o Sois le premier à acheter certains produits.
- o Obtiens des points bonus ou doublés.

ET BIEN D'AUTRES CHOSES ENCORE !

Visit VIP.LEGO.com for more information!

Besuche VIP.LEGO.com für weitere Informationen!

Rends-toi sur VIP.LEGO.com pour en savoir plus !

Redeem your rewards in LEGO Stores and shop.LEGO.com.

Löse deine Prämien in den LEGO Stores und auf LEGO.com/shop ein.

Utilise tes récompenses dans les LEGO Stores et sur LEGO.com/shop



WIN

GO TO WWW.LEGO.COM/PRODUCTFEEDBACK
AND GIVE US YOUR SHORT **FEEDBACK**
ABOUT THIS LEGO® SET FOR A CHANCE
TO WIN A COOL LEGO PRIZE.



LEGO.com/productfeedback

GEWINNE



Erzähle uns auf
www.LEGO.com/productfeedback

etwas über die Erfahrungen, die du
mit diesem LEGO® Set gemacht hast,
und sichere dir die Chance auf einen
coolen LEGO Preis!

GAGNE



Rends-toi sur
www.LEGO.com/productfeedback

et donne-nous quelques commen-
taires sur ce produit LEGO® pour avoir
une chance de gagner un prix LEGO !

GANAN



Visita
www.LEGO.com/productfeedback

y envíanos tu opinión acerca de este
set LEGO®. ¡Participarás en el sorteo
de un premio LEGO!

获取奖品



登录
www.LEGO.com/productfeedback

给出关于此乐高®套装的简短反馈，
就有机会获得炫酷乐高奖品

경품 당첨 기회



www.LEGO.com/productfeedback

페이지로 이동하여 이 레고® 세트에
대한 간략한 피드백을 보내 주시고
멋진 레고 경품을 탈 수 있는 기회도
잡으십시오

ЗАПОЛНИ АНКЕТУ И ПОЛУЧИ ПРИЗ



Перейди по ссылке
www.LEGO.com/productfeedback

ответь всего на несколько вопро-
сов об этом наборе LEGO®, и у тебя
появится шанс выиграть замеча-
тельный приз от компании LEGO.