

The LEGO logo is displayed in its characteristic white font on a red rectangular background.

BIONICLE®

70792



WARNING: CHOKING HAZARD.
Toy contains small parts and a small ball.
Not for children under 3 years.



LEGO.com/bionicle





AVERTISSEMENT :

RISQUE D'ÉTOUFFEMENT. Le jouet contient des petites pièces ainsi qu'une petite boule. Il ne convient pas aux enfants de moins de 3 ans.



ADVERTENCIA:

PELIGRO DE ASFIXIA. Juguete que contiene partes pequeñas y una pelota pequeña. No recomendado para niños menores de 3 años.

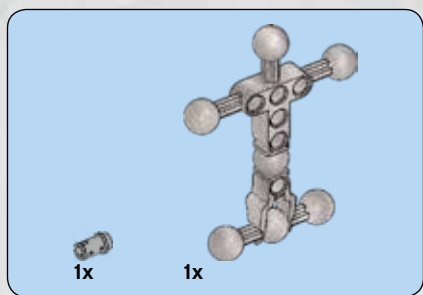

1

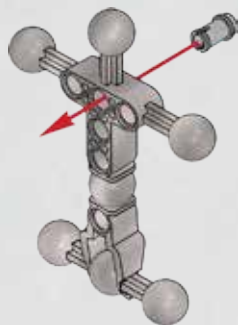

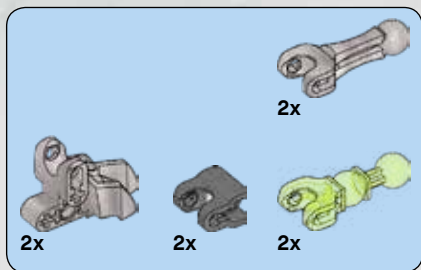

2

1

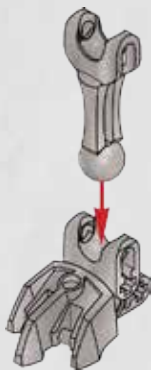

2



2x

3

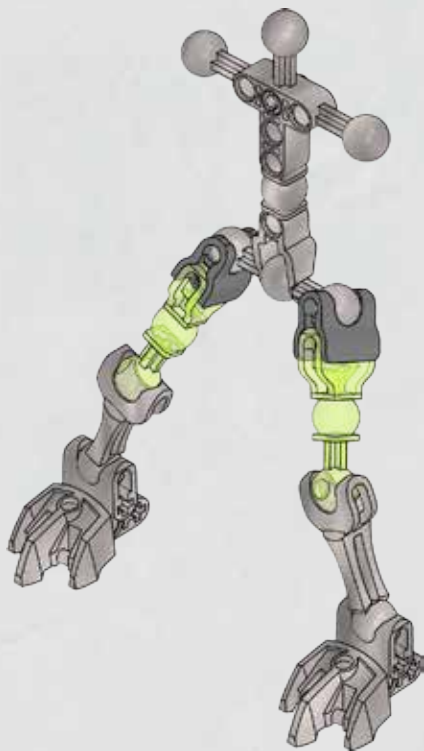

6



2x



2x

4

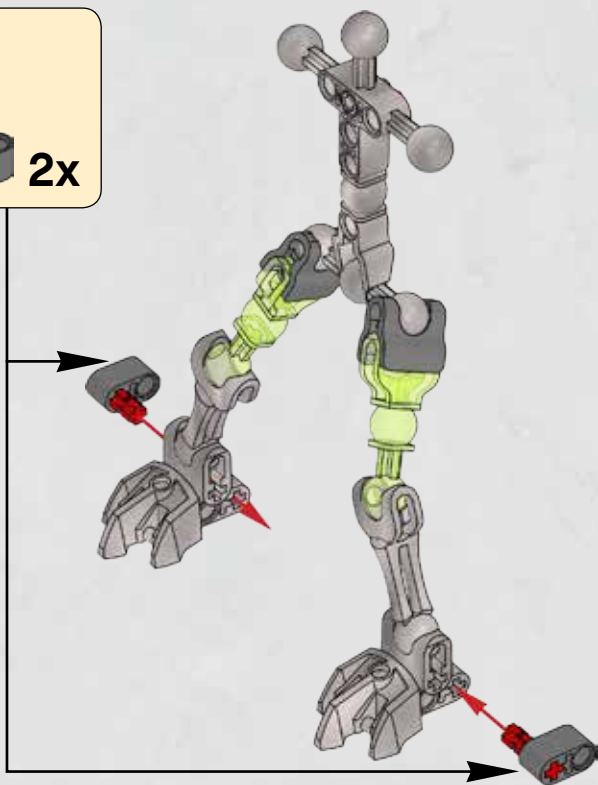
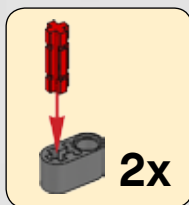

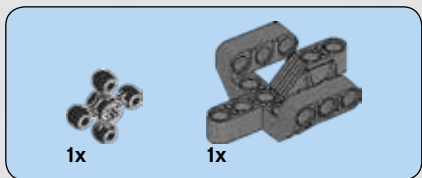

5

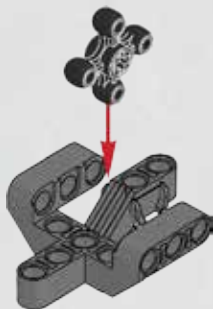

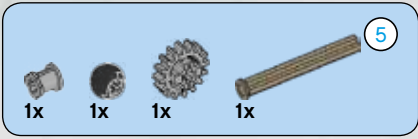

6

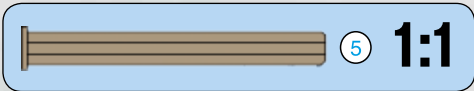
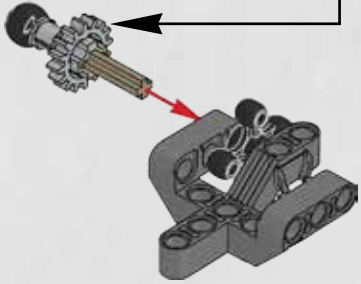
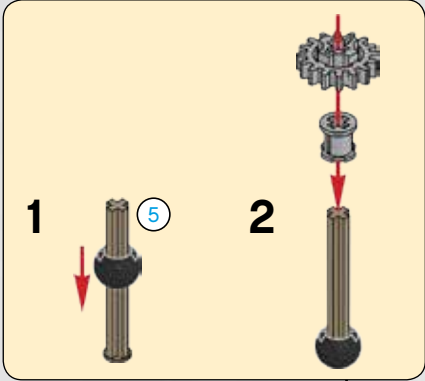



1x

7

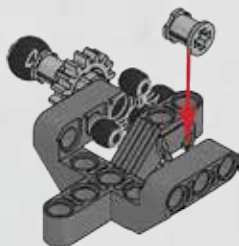

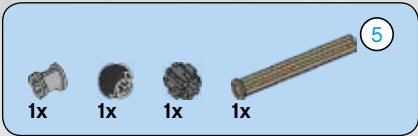

8

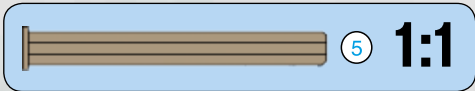
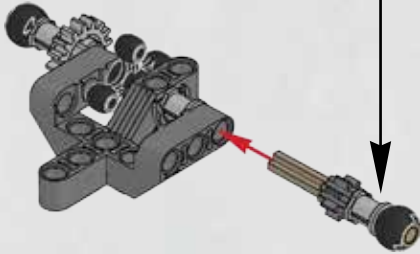
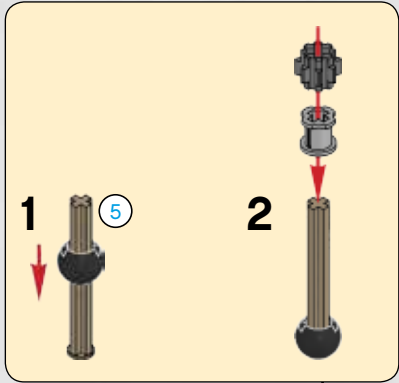

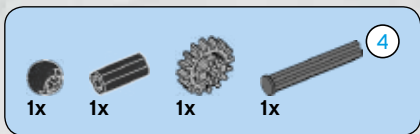

9

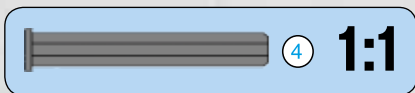
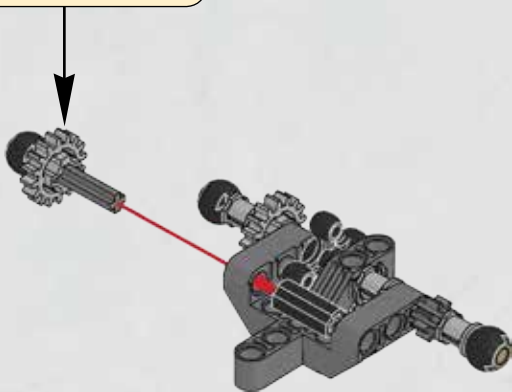
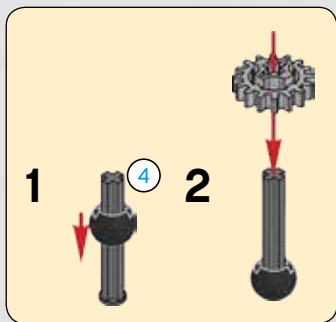



1x



1x

10

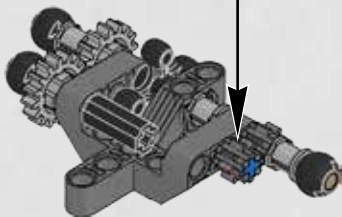
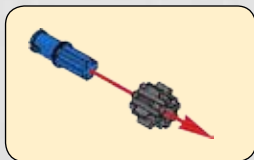

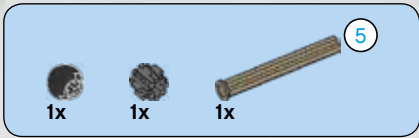

11

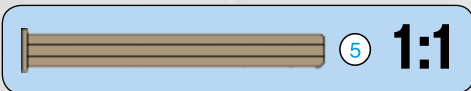
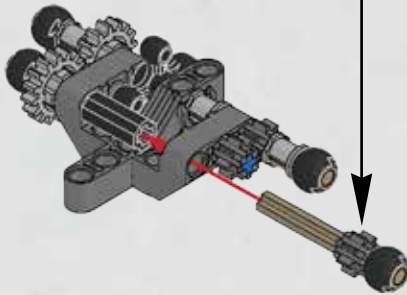
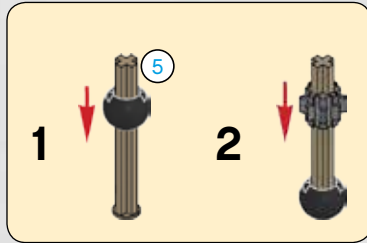



1x

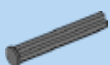

4

1x

12

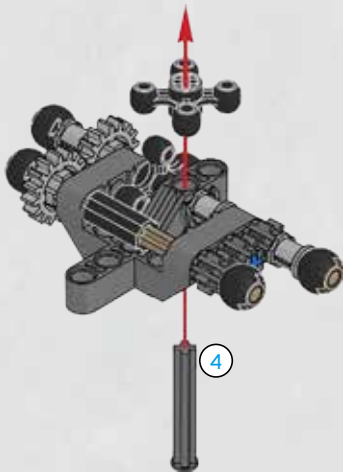

4

1:1



1x



1x

13

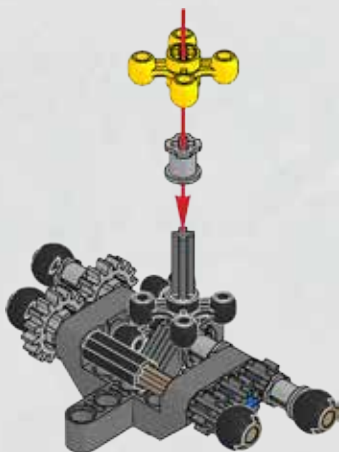



2x

14

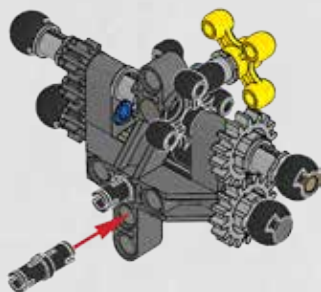

15

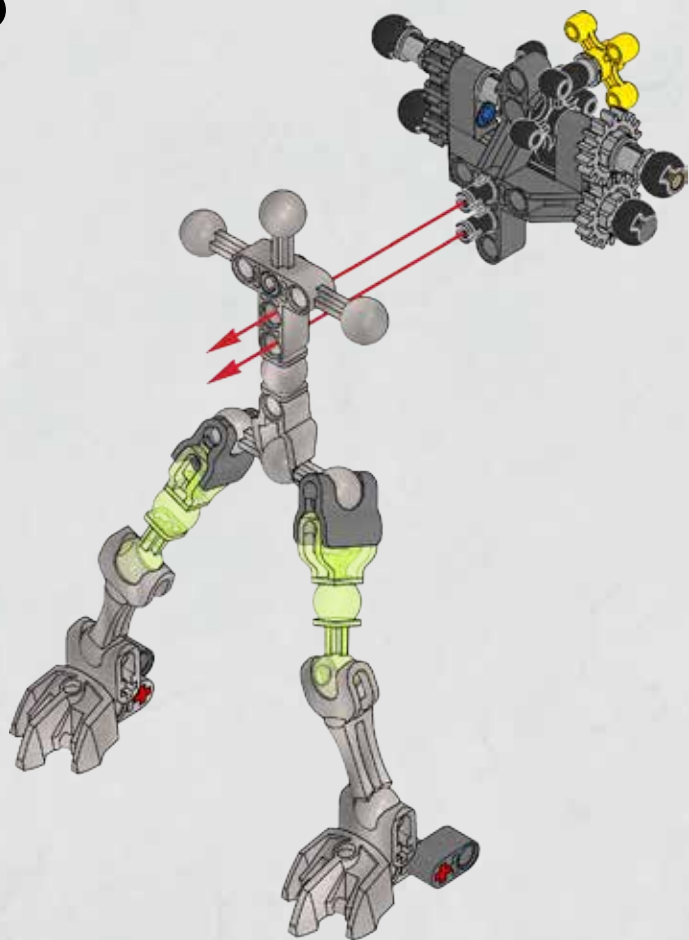

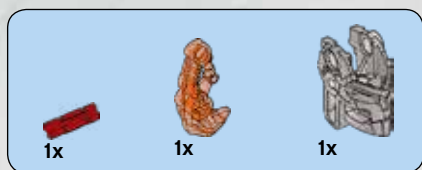

16

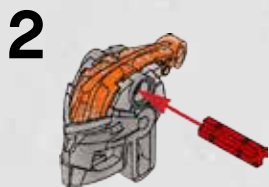
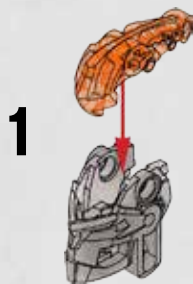

17

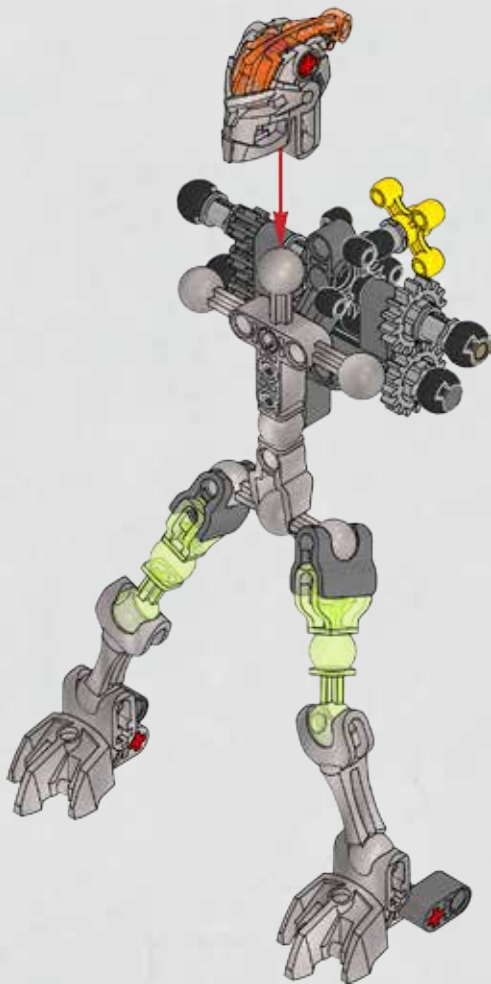



18

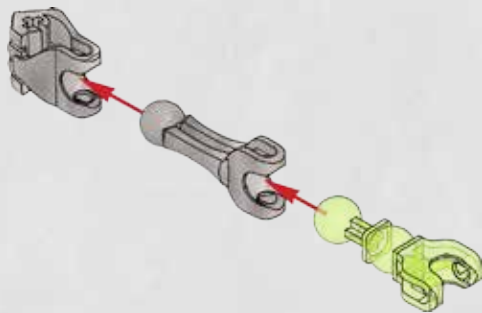

4x

19

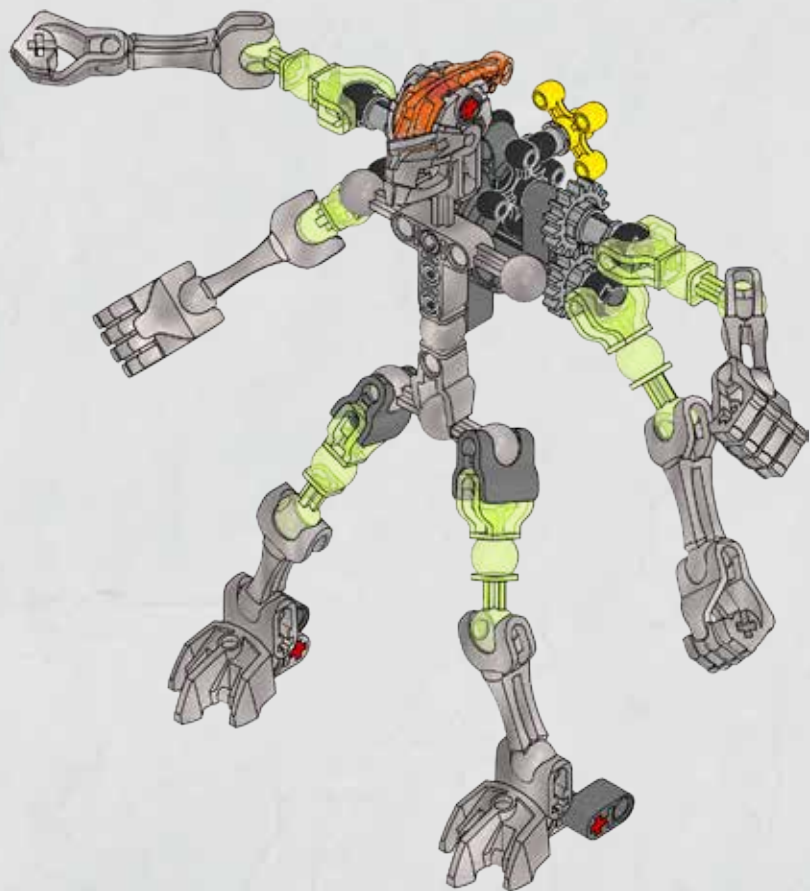

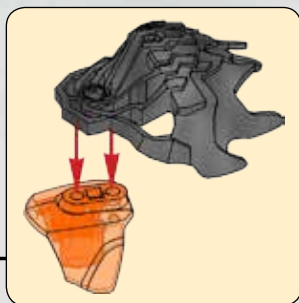
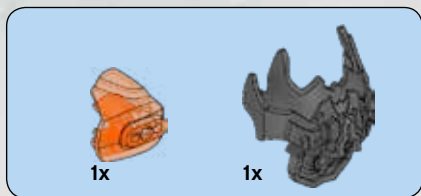

20

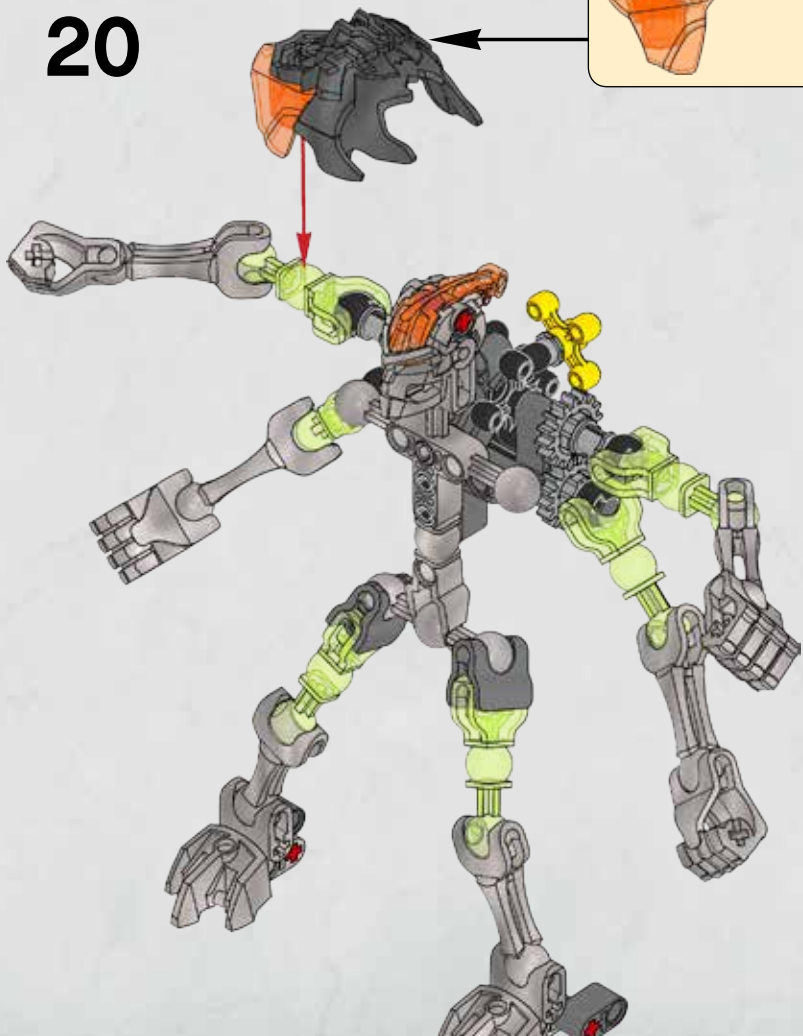



1x



1x

21

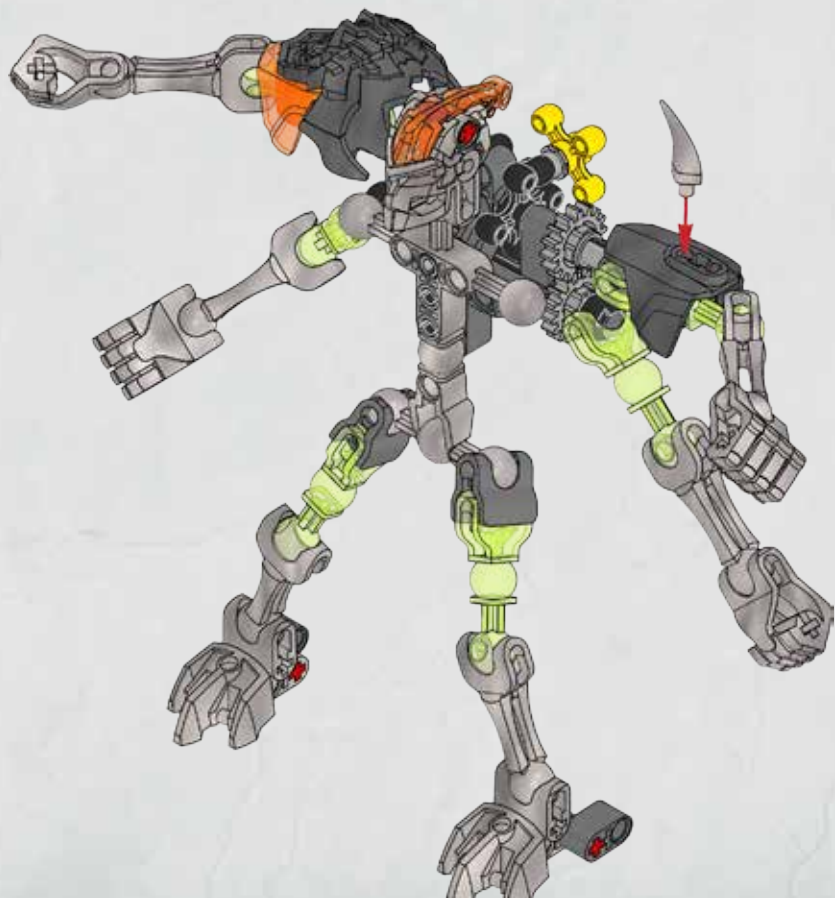



22

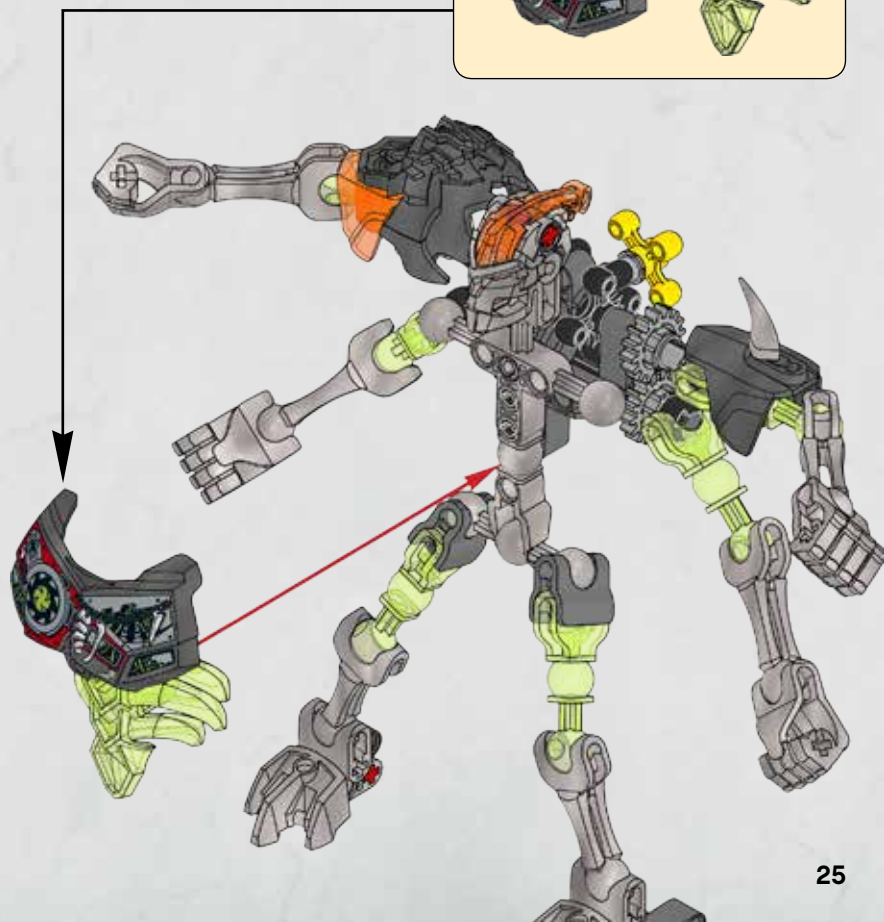
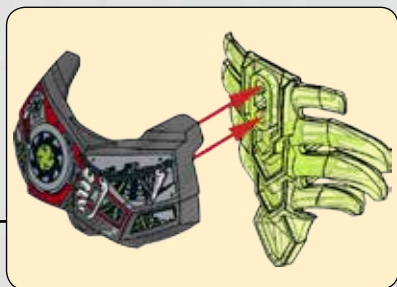

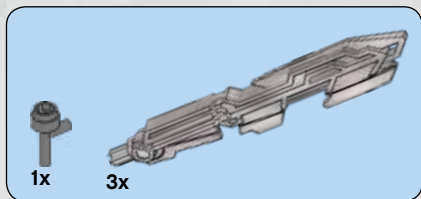

23



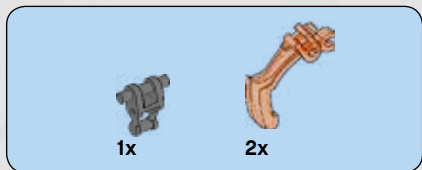

24

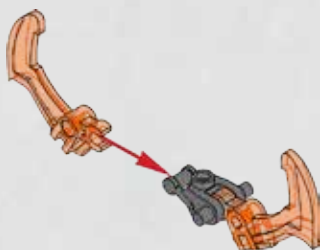

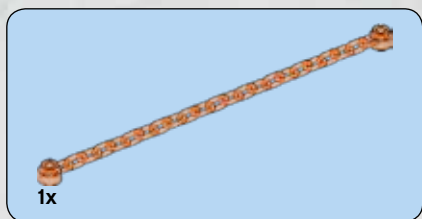

25

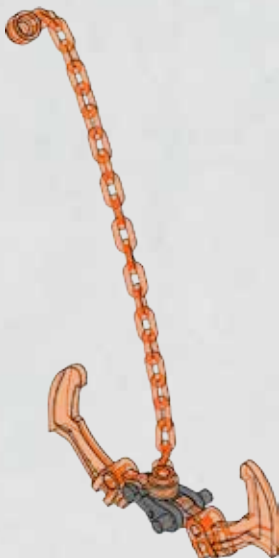

26





27



3x
4142865

1x
4206482

1x
4203493

4x
4286267

2x
4121715

1x
4512363

2x
4248204

1x
6114401

2x
6111272

1x
6102640

1x
6045953

3x
6055631

1x
4211483

4x
4211622

2x
4640536

1x
4521512

1x
4566028



2x
6006141

1x
6102645

2x
6106472

2x
6083620

3x
6012451

6x
6107475

1x
6114322

1x
4617190

6x
6114326

1x
6115891

4x
4619077

2x
6100892

1x
6102606

1x
6106710

3x
6114379

1x
6061054

1x
6114328

1x
6115546

1x
6114250



Customer Service
Kundenservice
Service Consommateurs
Servicio Al Consumidor

LEGO.com/service or dial



: 00800 5346 5555

: 1-800-422-5346



70791



70792



70793



 LEGO.com/bionicle/bi

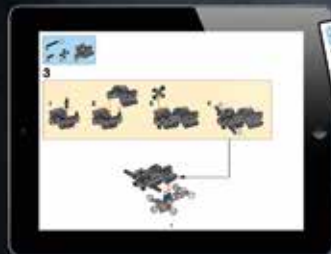

 LEGO.com/bionicle



Download App
Télécharger l'application
Descarga la App



Available on the
 **App Store**

Apple, the Apple logo, iPad, iPhone and iPod touch are trademarks of Apple Inc.
Apple, le logo Apple, iPad, iPhone et iPod touch sont des marques de commerce d'Apple Inc.
Apple, el logotipo de Apple, iPad, iPhone e iPod touch son marcas comerciales de Apple Inc.

GET IT ON

Google Play is a trademark of Google Inc.
Google Play est une marque de commerce de Google Inc.
Google Play es una marca comercial de Google Inc.





70791

70794



70795



70792



70793

WIN

GO TO WWW.LEGO.COM/PRODUCTFEEDBACK
AND GIVE US YOUR SHORT **FEEDBACK**
ABOUT THIS LEGO® SET FOR A CHANCE
TO WIN A COOL LEGO PRIZE.



LEGO.com/productfeedback

GEWINNE



Erzähle uns auf
www.LEGO.com/productfeedback

etwas über die Erfahrungen, die
du mit diesem LEGO® Set gemacht
hast, und sichere dir die Chance
auf einen coolen LEGO Preis!

GAGNE



Rends-toi sur
www.LEGO.com/productfeedback

et donne-nous quelques com-
mentaires sur ce produit LEGO®
pour avoir une chance de gagner
un prix LEGO !

GANA



Visita
www.LEGO.com/productfeedback

y envíanos tu opinión acerca de
este set LEGO®. ¡Participarás en el
sorteo de un premio LEGO!

获取奖品



登录
www.LEGO.com/productfeedback

给出关于此乐高®套装的简短反馈，
就有机会获得炫酷乐高®奖品

경품 당첨 기회



www.LEGO.com/productfeedback

페이지로 이동하여 이 레고® 세트에
대한 간단한 피드백을 보내 주시고
멋진 레고 경품을 탈 수 있는 기회도
잡으십시오

ЗАПОЛНИ АНКЕТУ И ПОЛУЧИ ПРИЗ



Перейди по ссылке
www.LEGO.com/productfeedback

ответь всего на несколько во-
просов об этом наборе LEGO®,
и у тебя появится шанс выиграть
замечательный приз от компа-
нии LEGO.

LEGO, the LEGO logo and BIONICLE are trademarks of the/son des marques de commerce du/
son marcas registradas de LEGO Group. ©2015 The LEGO Group.

6123864