



CREATOR

10245



2

 LEGO.com

EXPERT



1



2



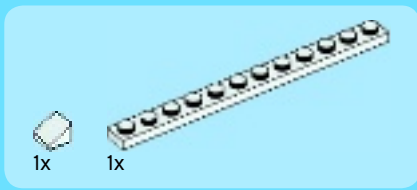

1

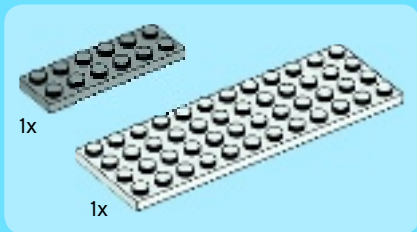
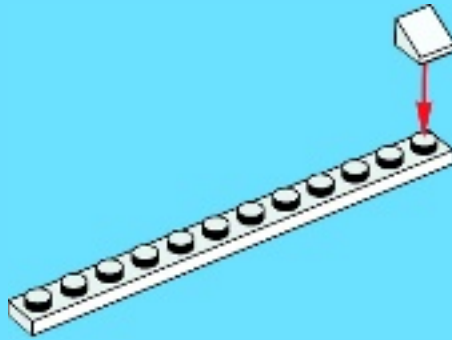

2

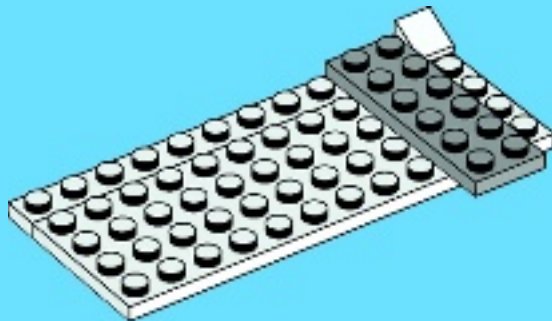



2x



1x

3

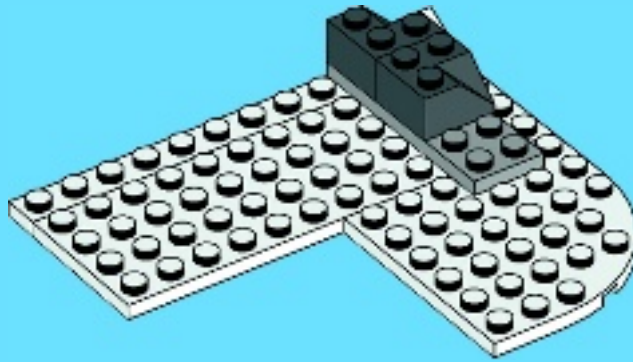

1x



1x



1x

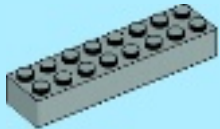

1x



1x

4

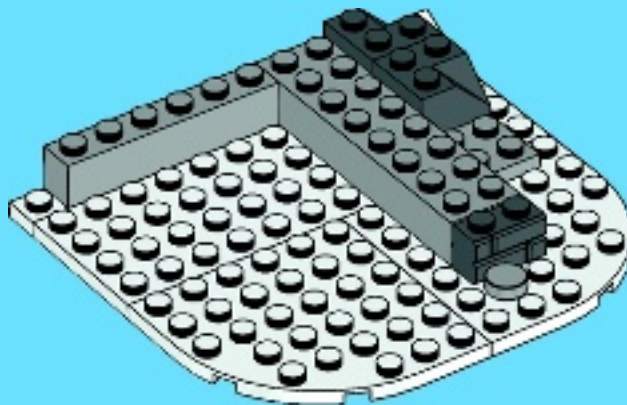



5

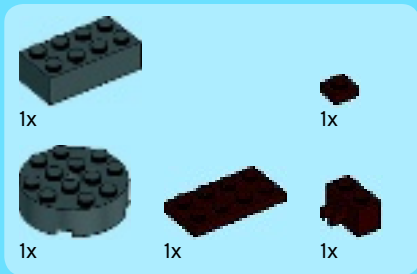
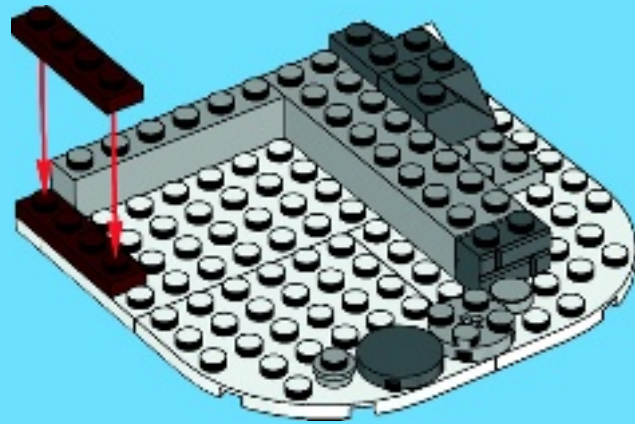

6



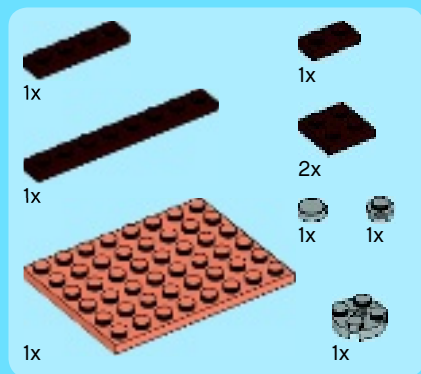

7

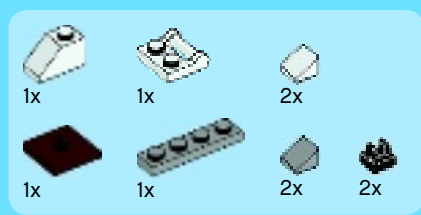
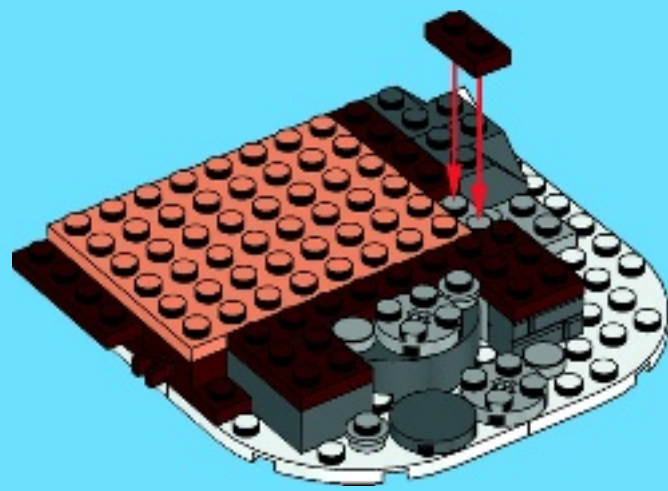

8

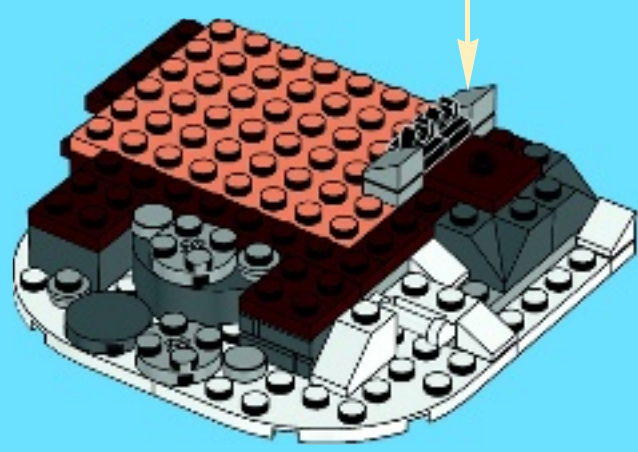
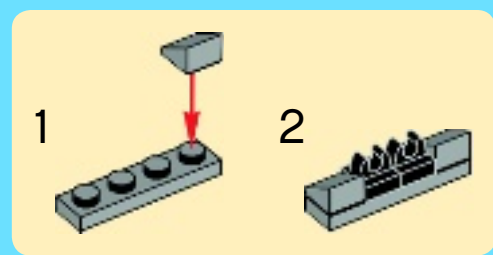

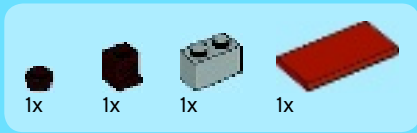

9

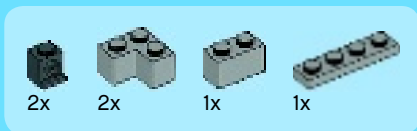
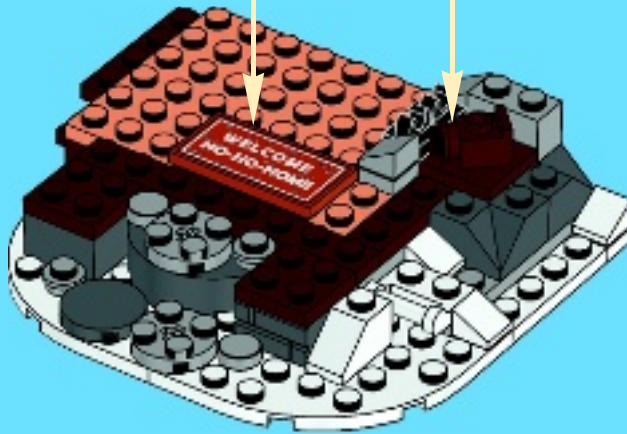
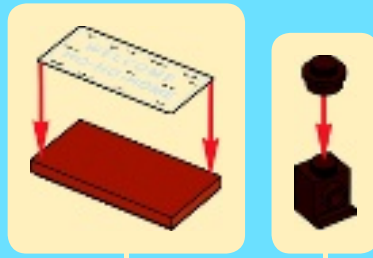

10

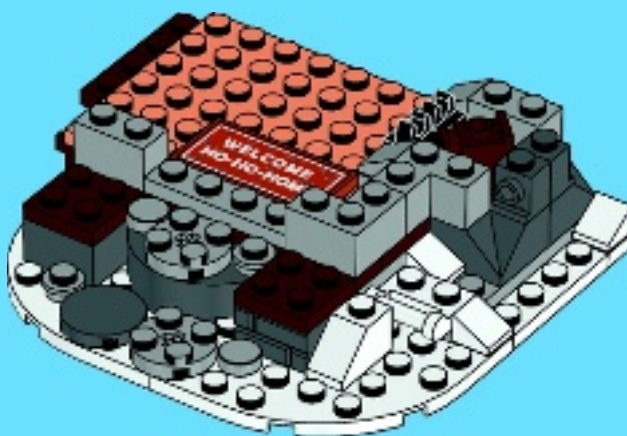



1x



2x



2x



1x

11



2x



2x



1x



1x



2x



2x

12

1

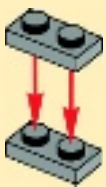

2

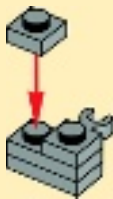

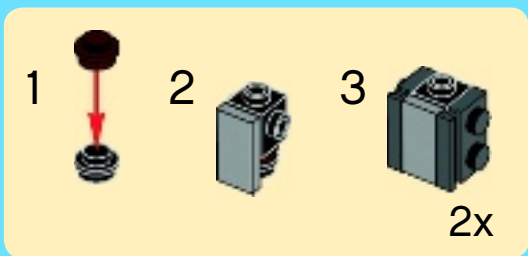
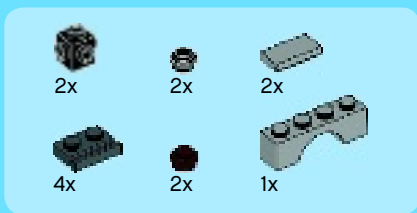

13

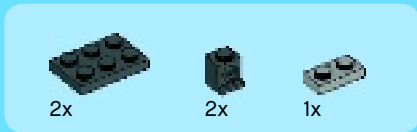
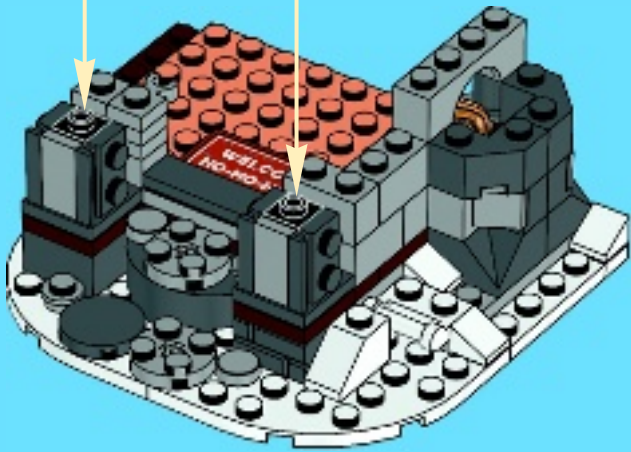

14

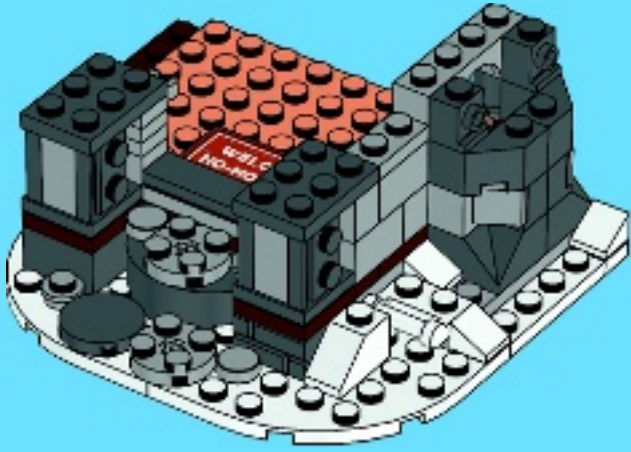



1x



1x



1x



2x



1x



2x



2x

15

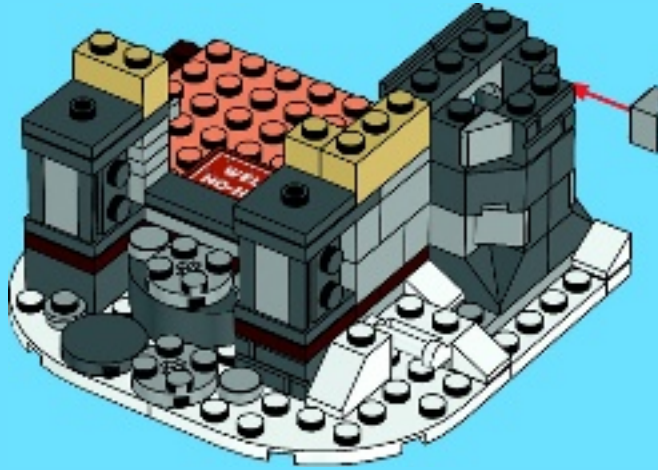

2x



2x

16

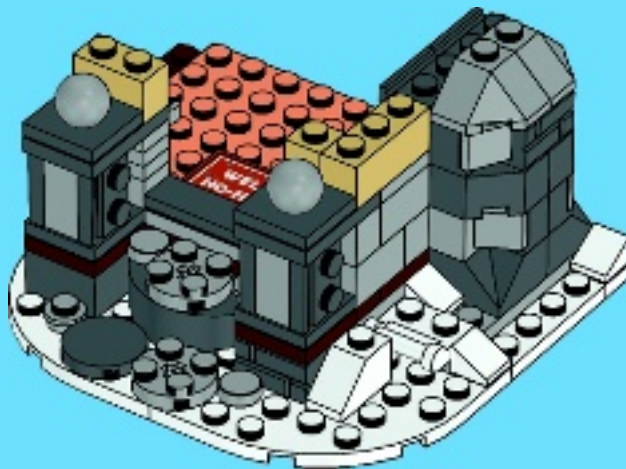

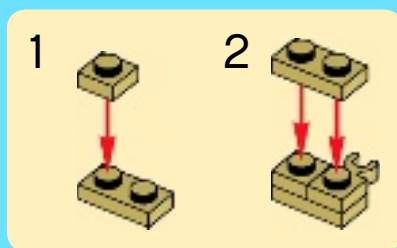
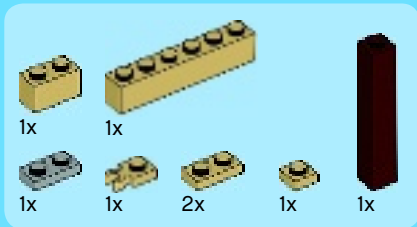

17

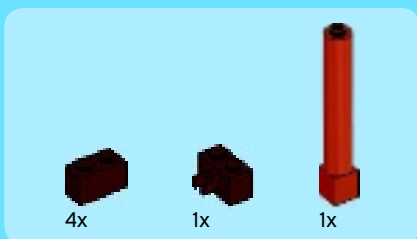
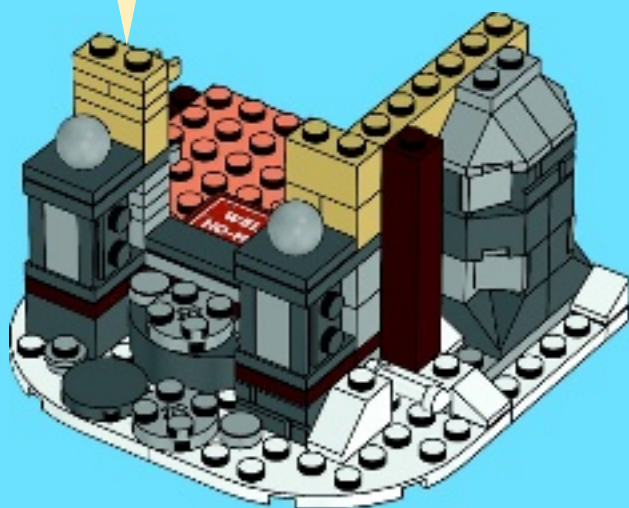

18

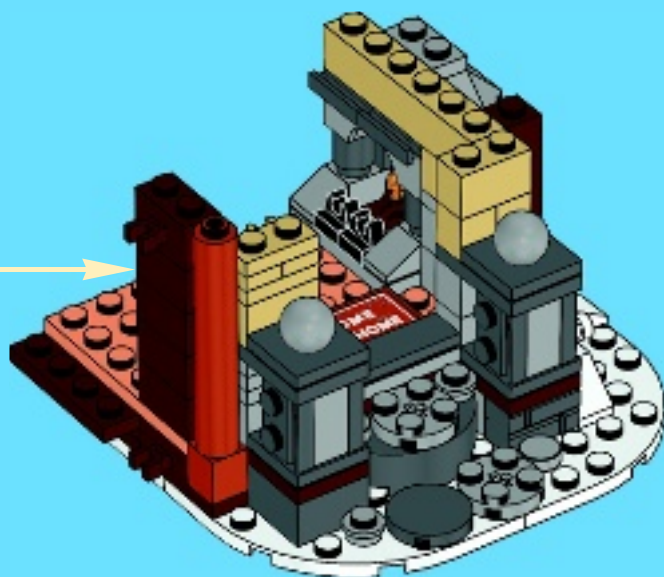
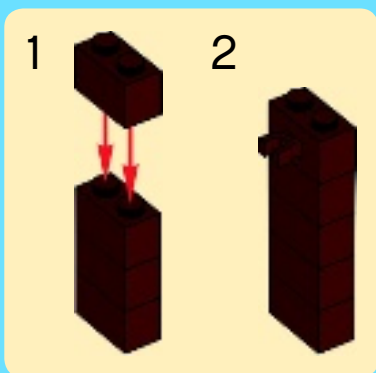

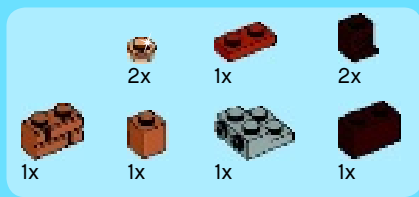

19

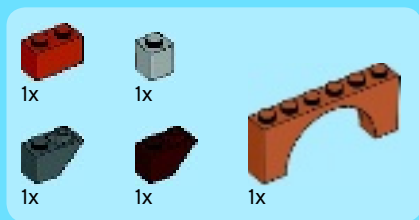
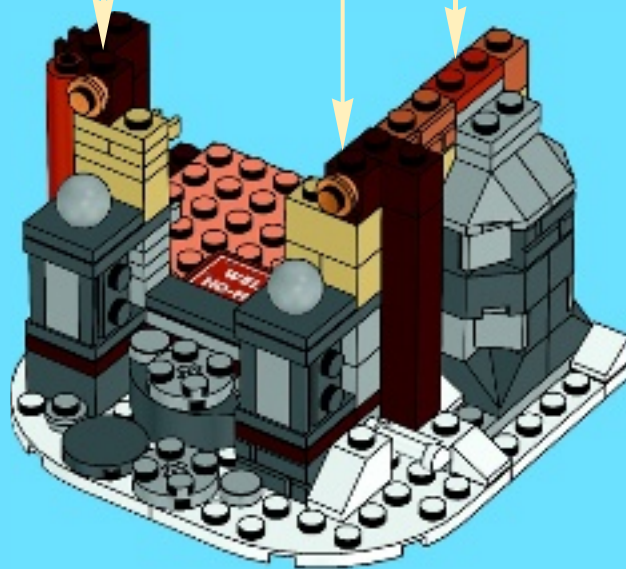

20

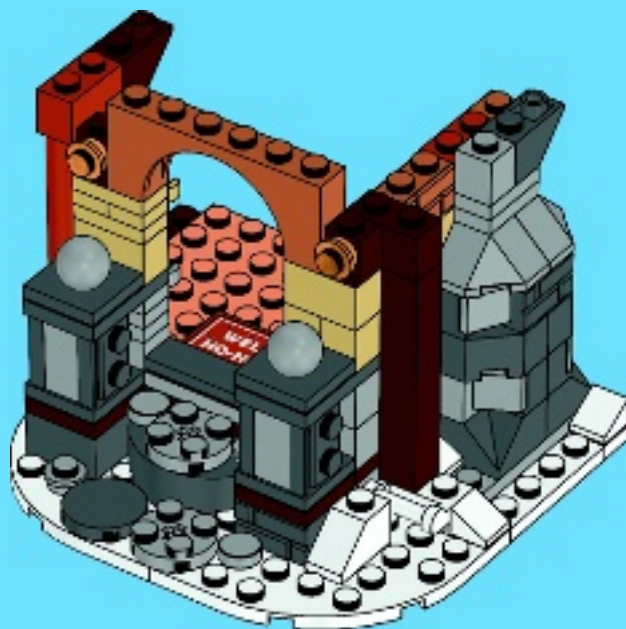

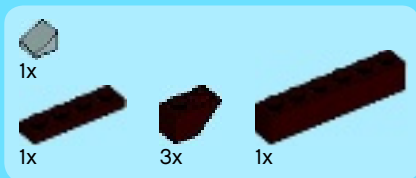

21

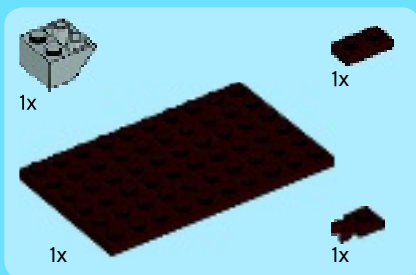
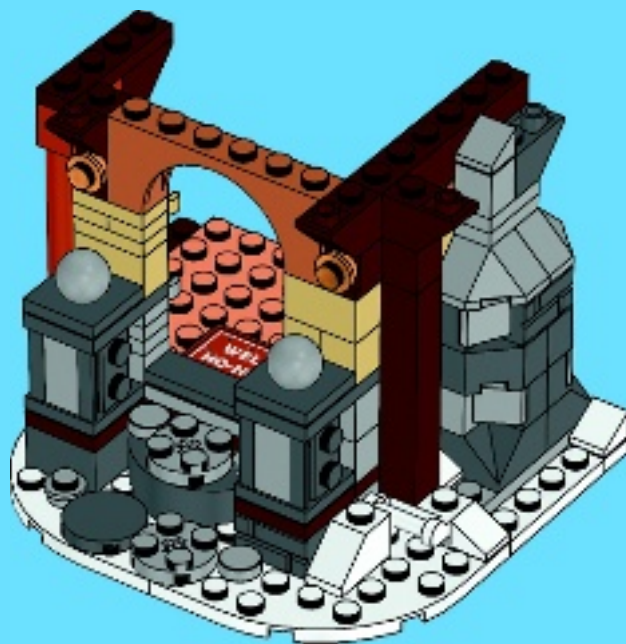

22



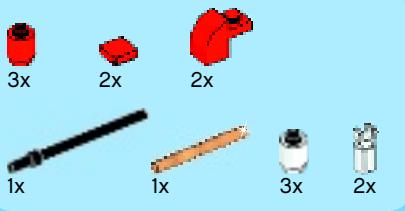

23

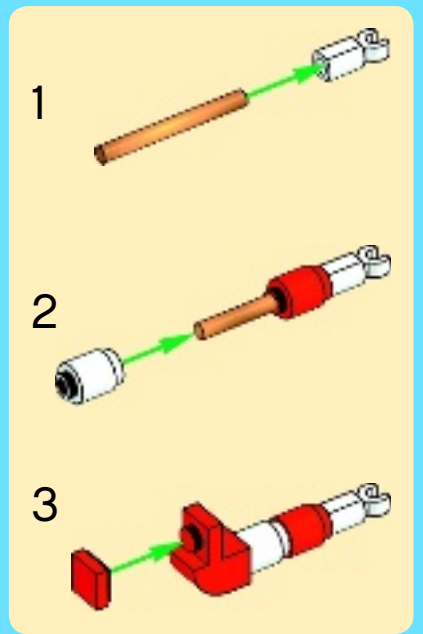
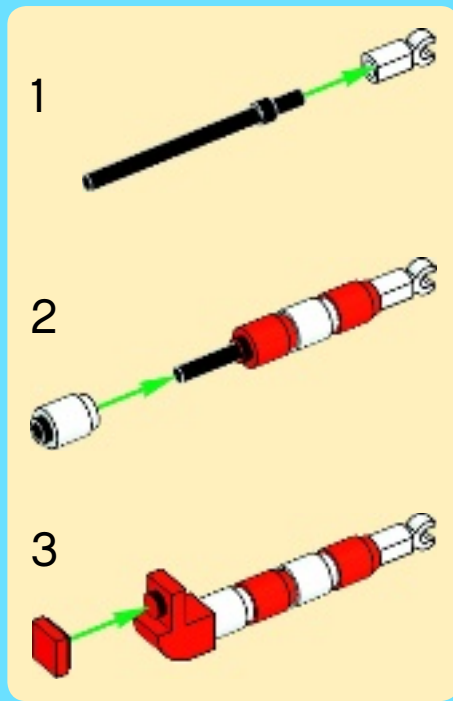



6x



2x



4x

24

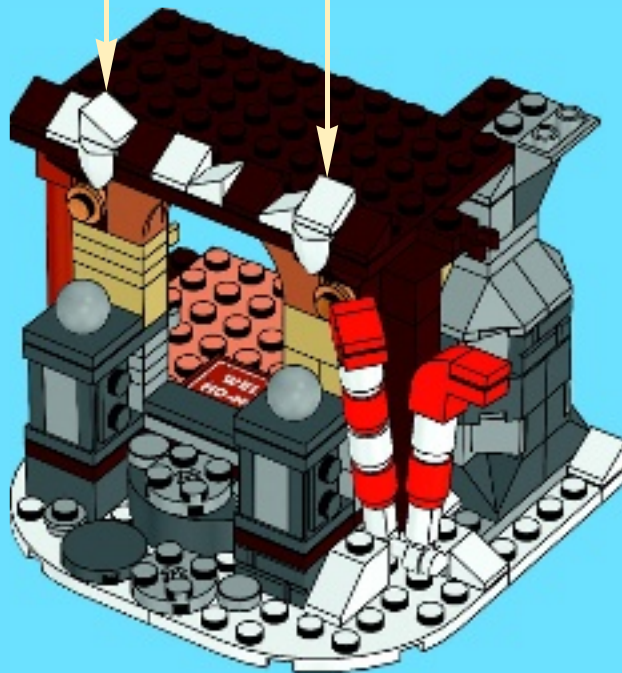
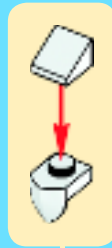
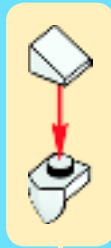

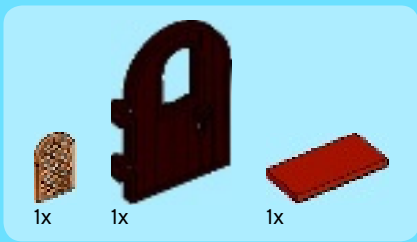

25

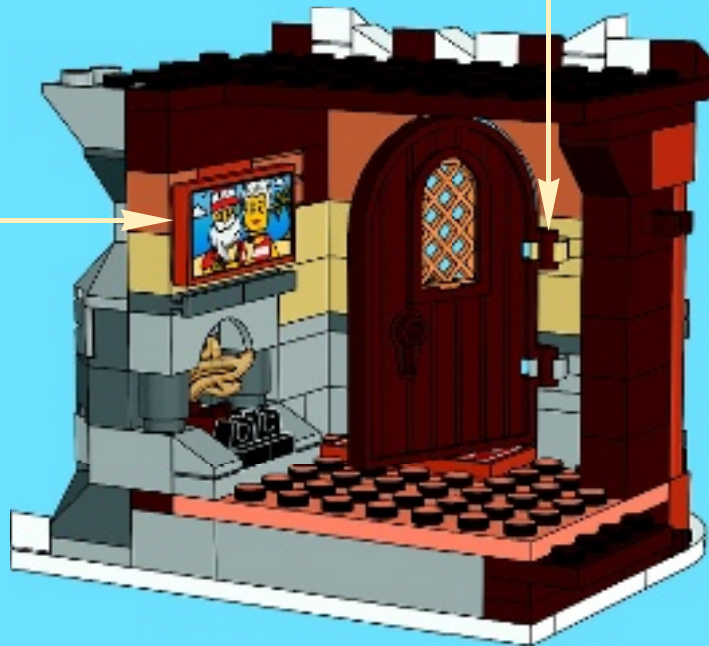



1x



2x



1x



3x



2x

26



1x



2x



1x



1x



1x

27

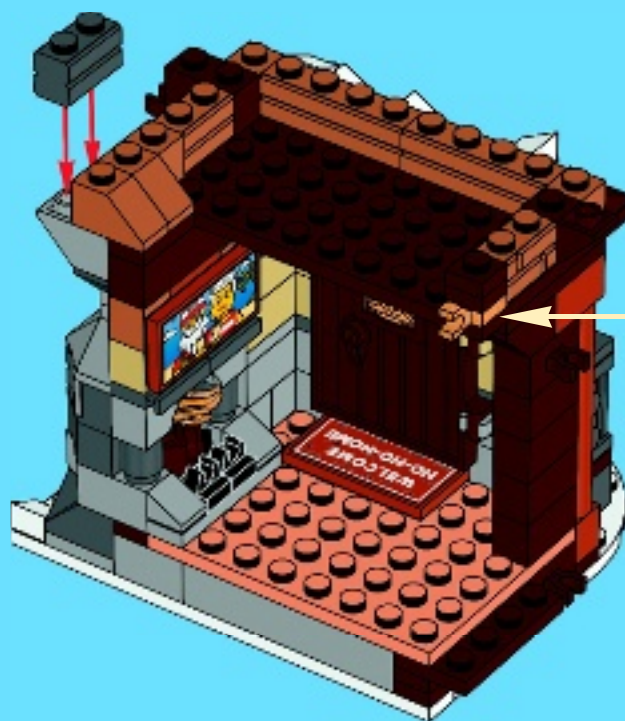



1x



1x



9x



1x

28

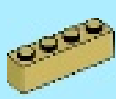

2x



1x



1x



2x



1x



2x



2x

29

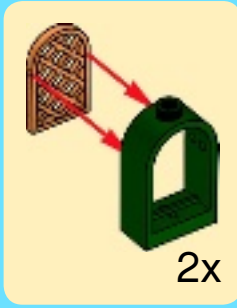

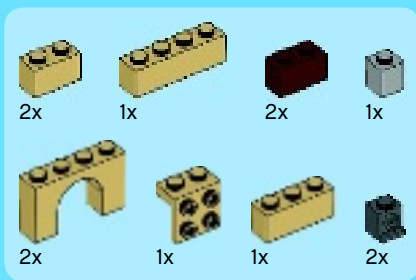

30

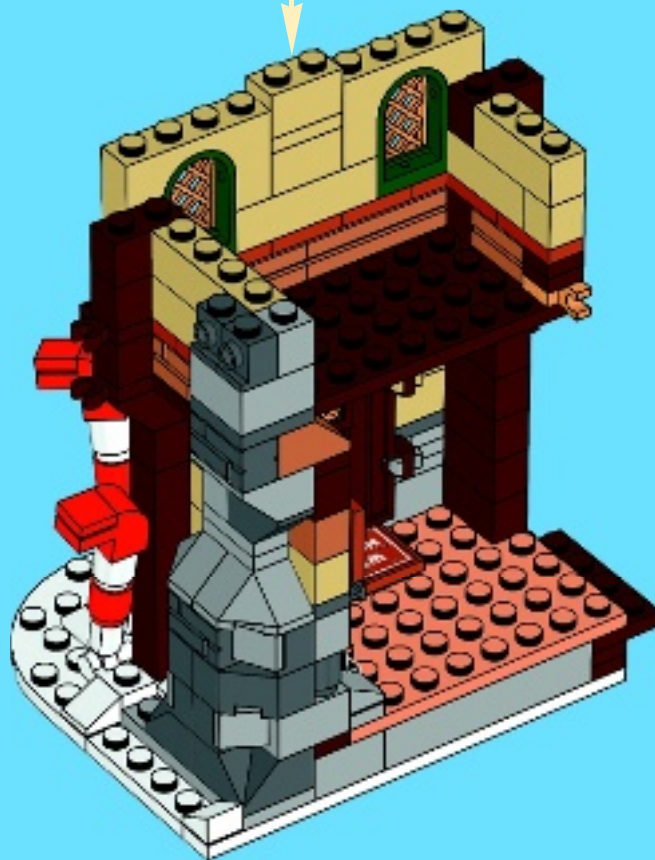
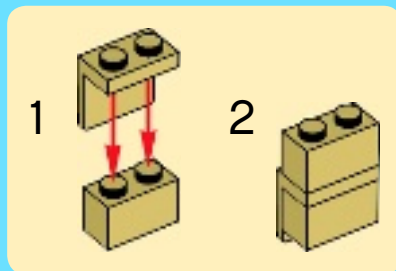

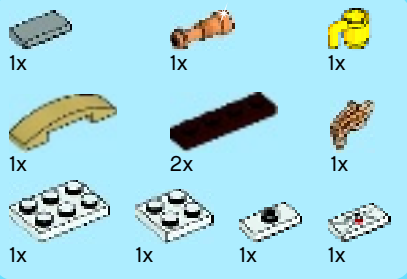

31

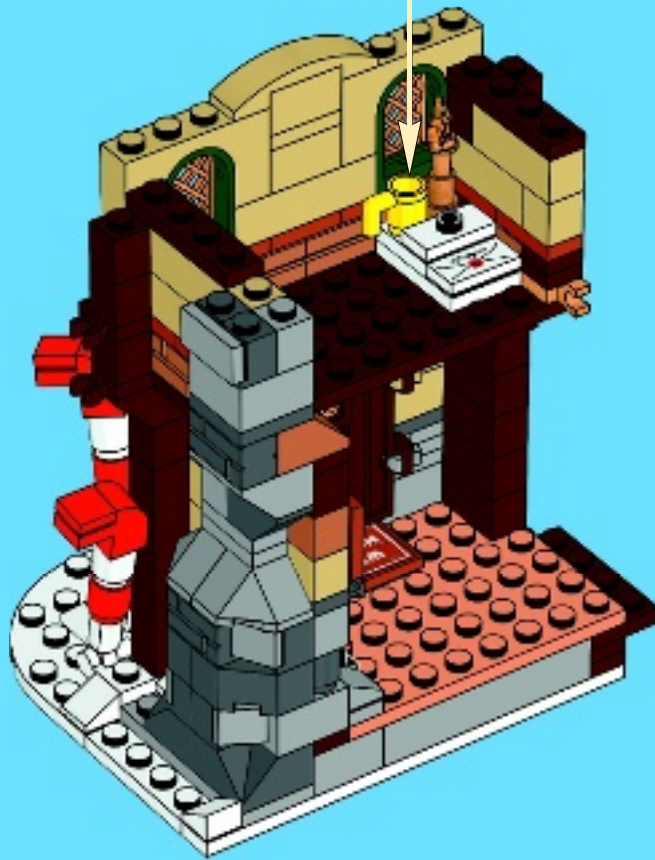

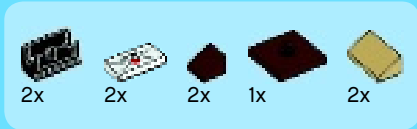

32





1



2



3



4

1



2





5



6

1



2



2x

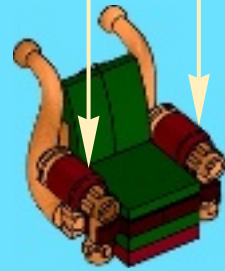

33

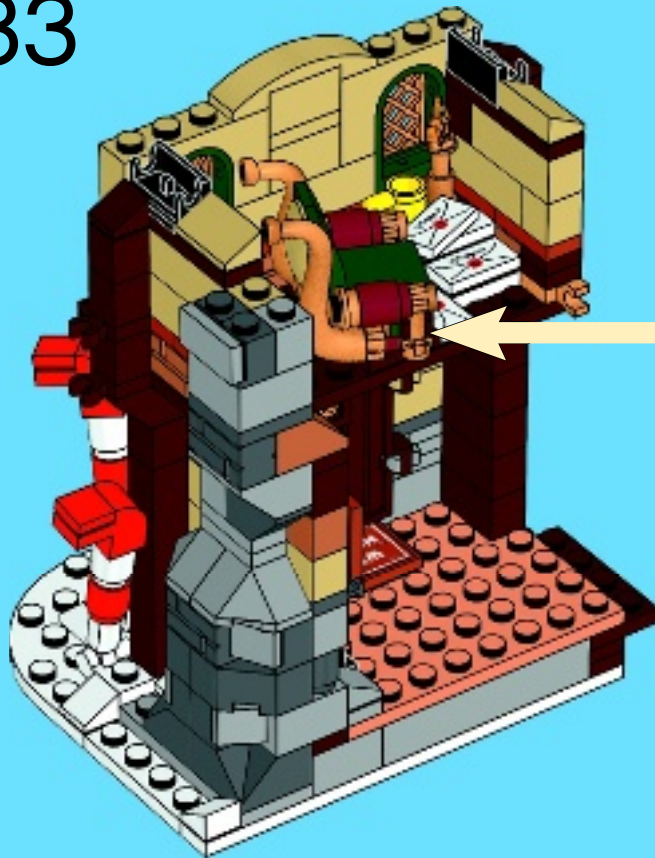

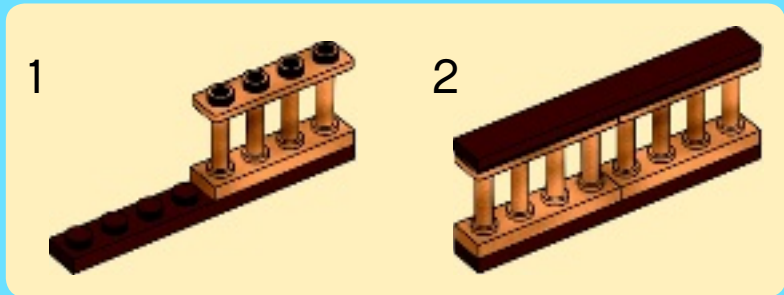
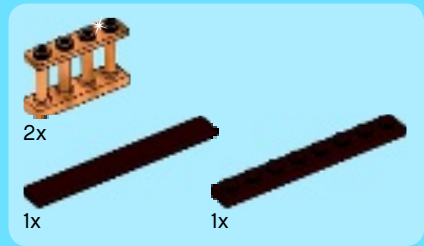

34

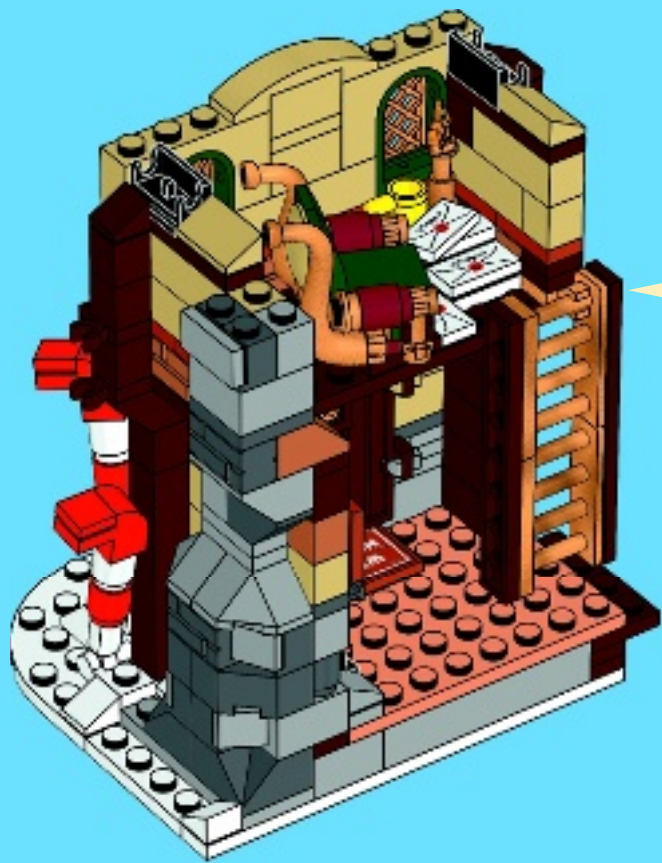

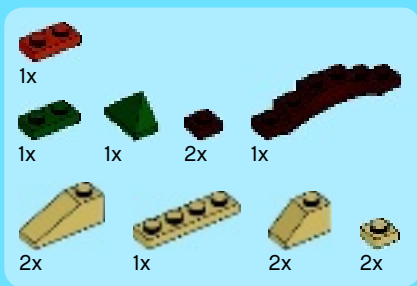

35

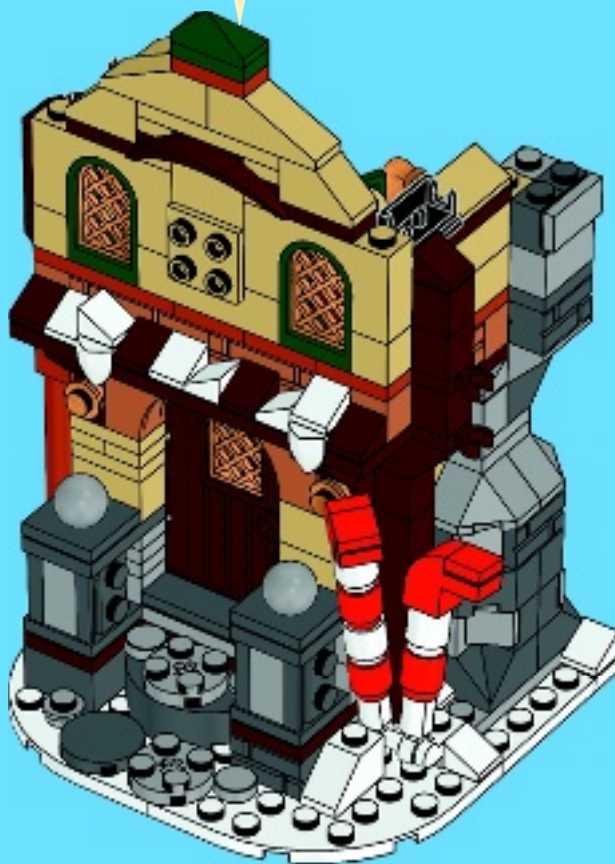
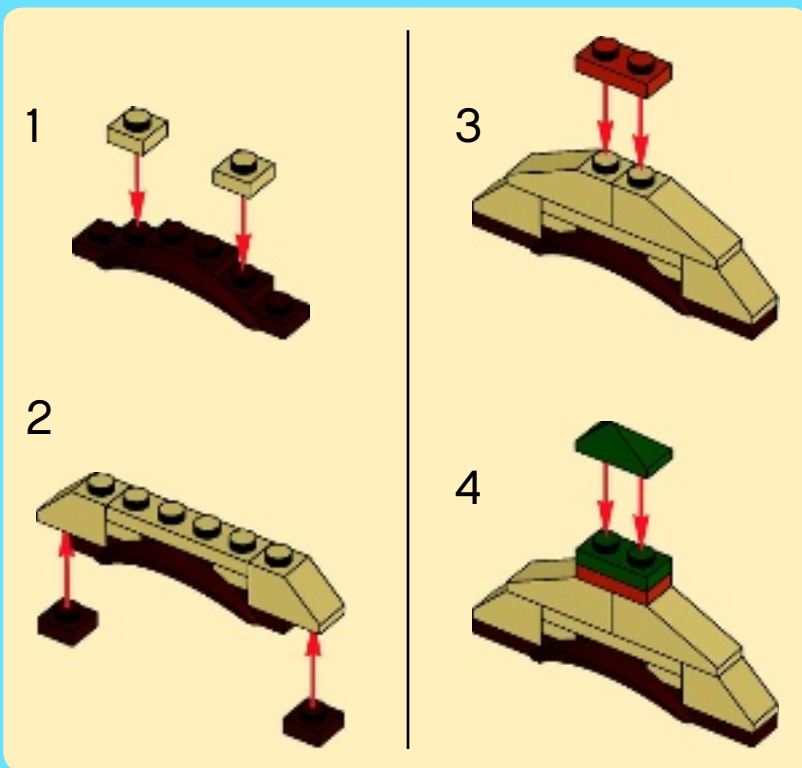



1x



4x



1x



2x



1x



1x

1

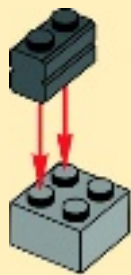

2

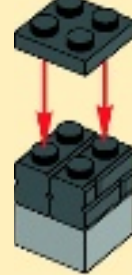

3



36



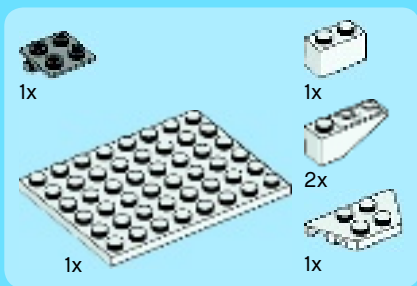

37

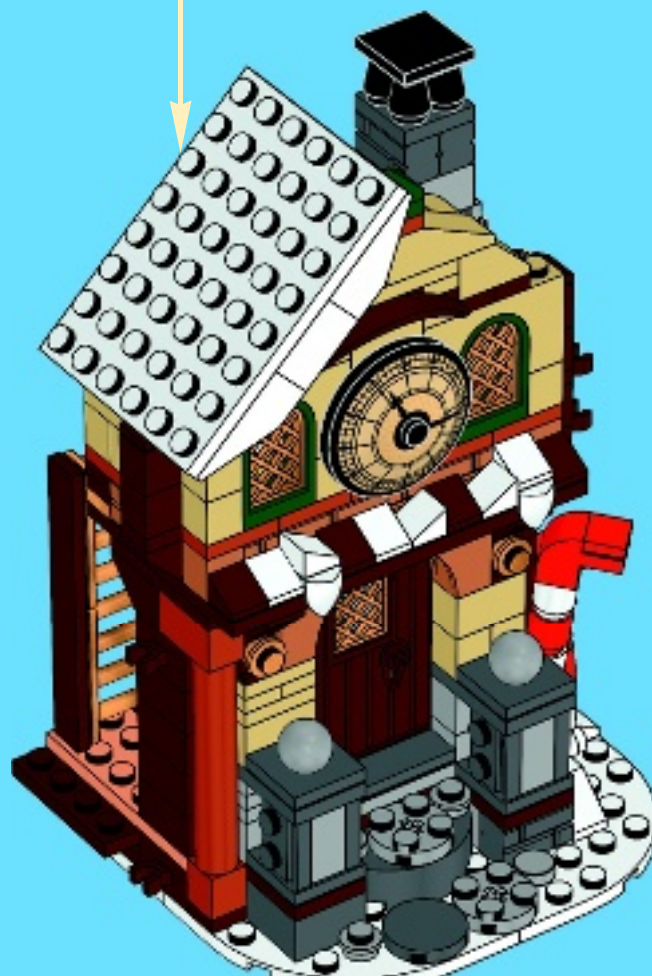
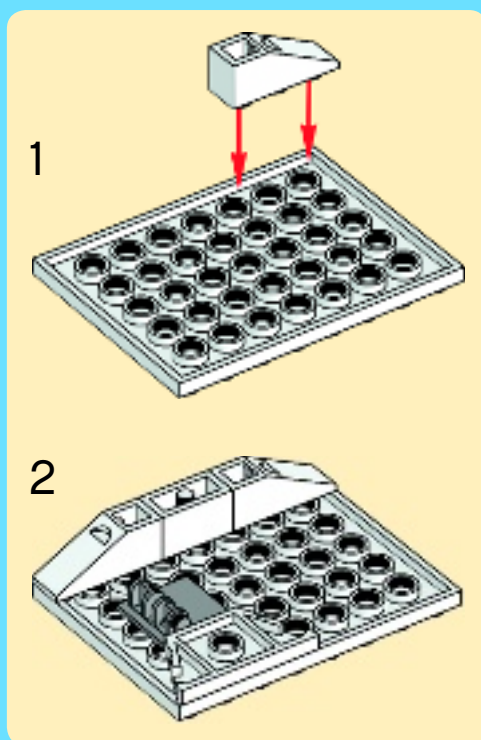

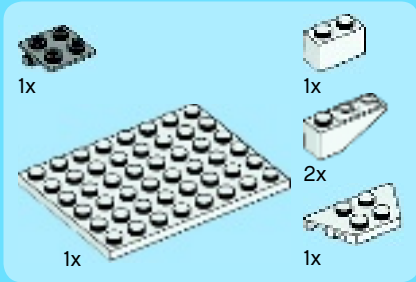

38

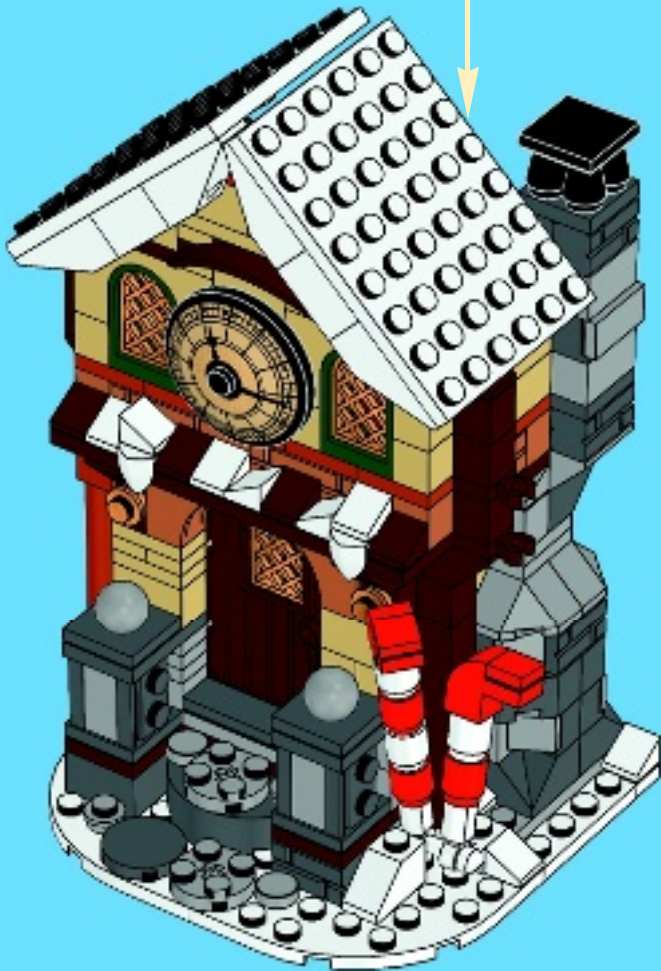
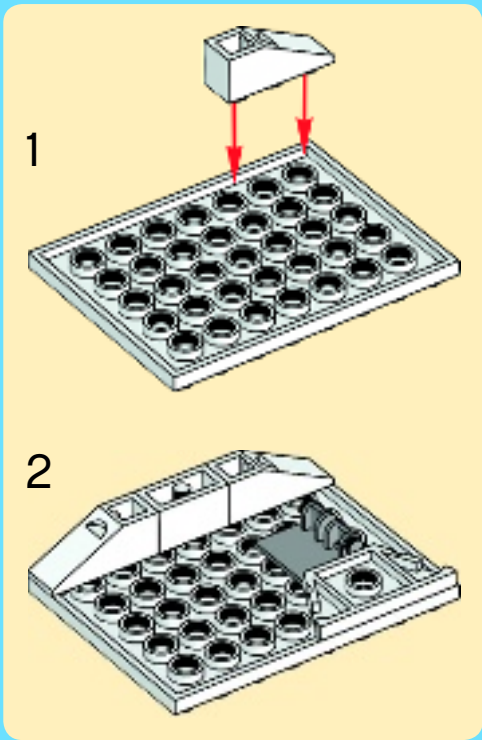



39

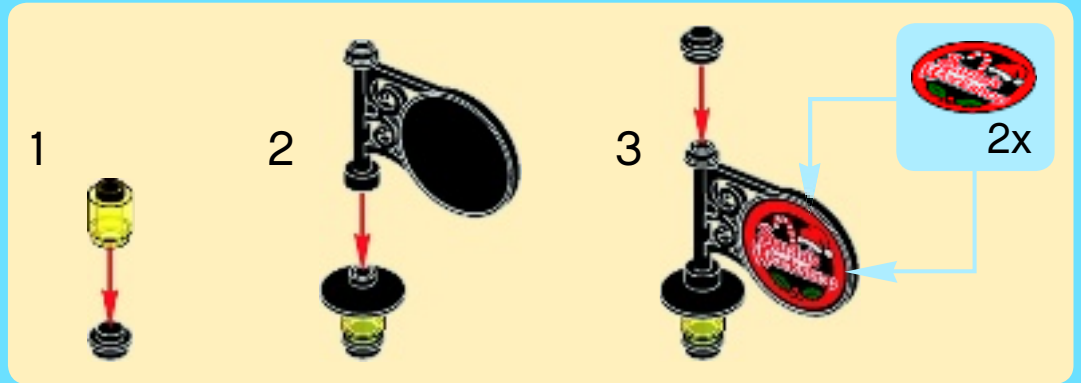

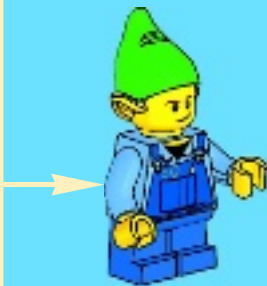
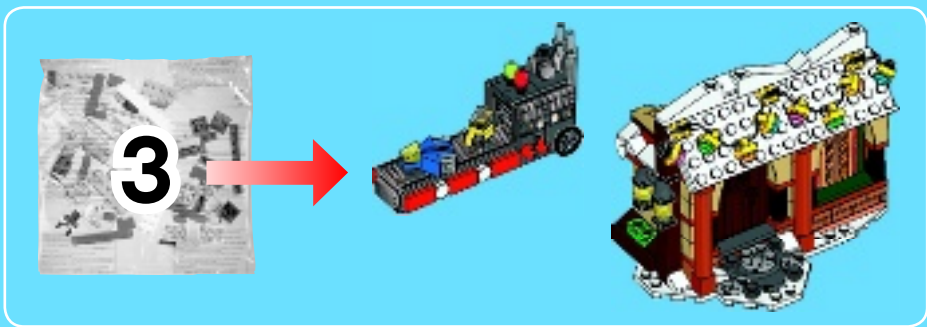

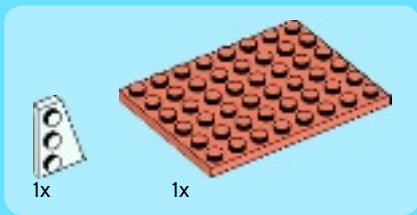

1

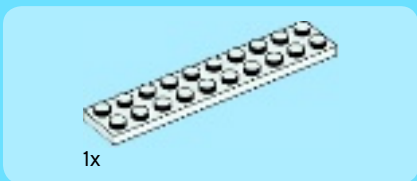
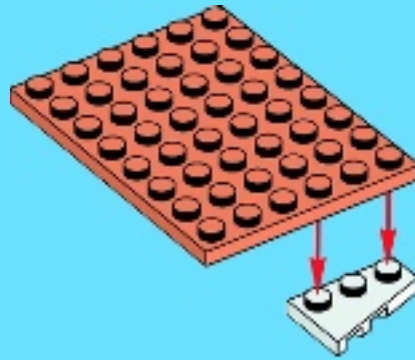

2

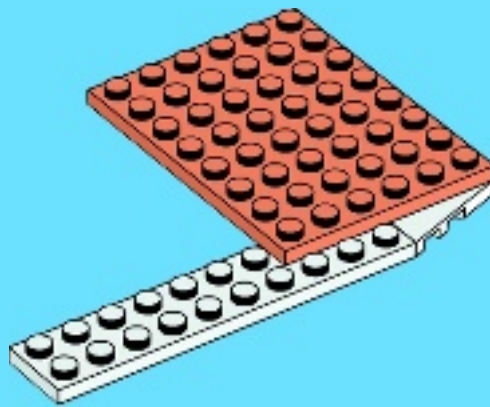



1x

3

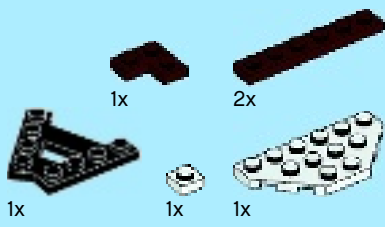
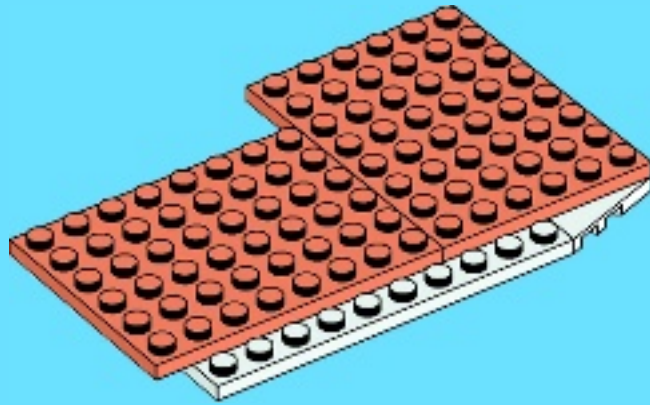

4

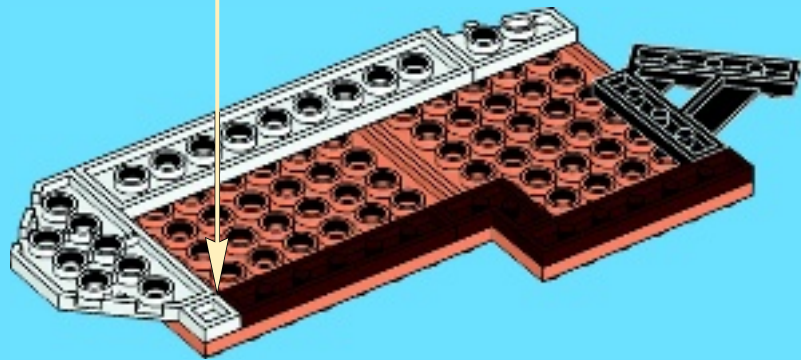

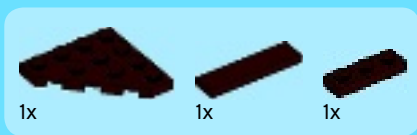

5

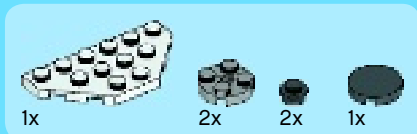
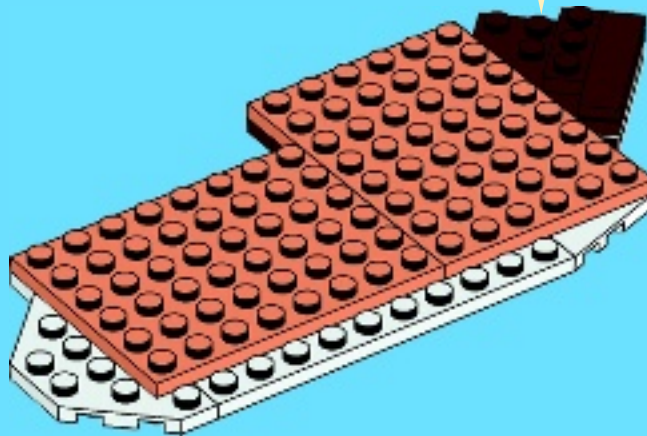
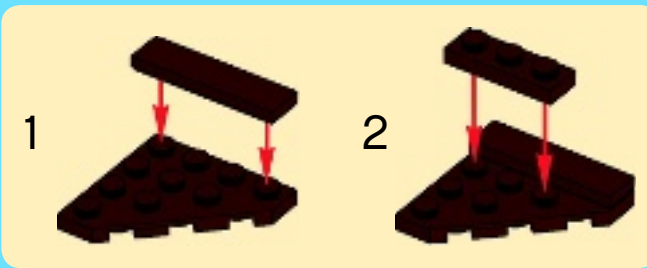

6

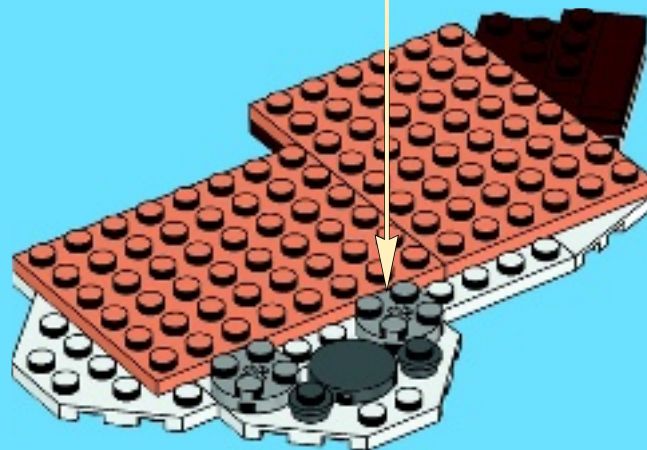

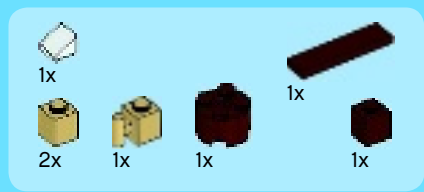

7

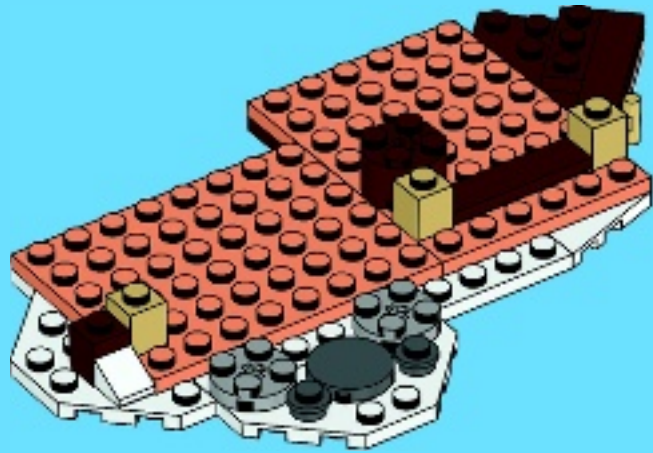

8





9



10

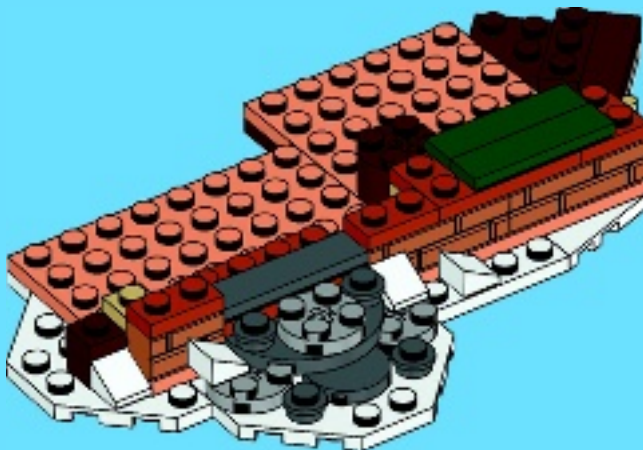



11

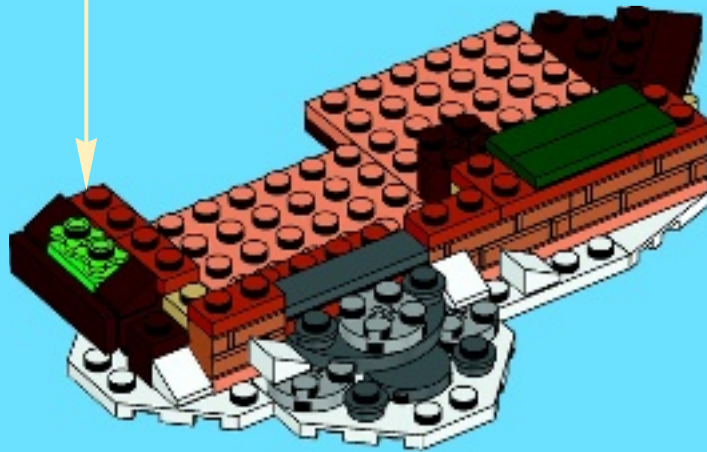
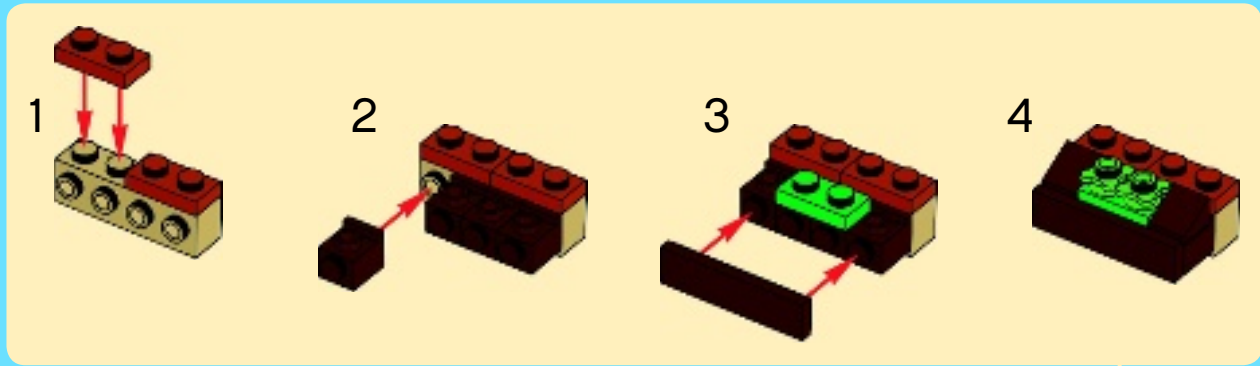



12

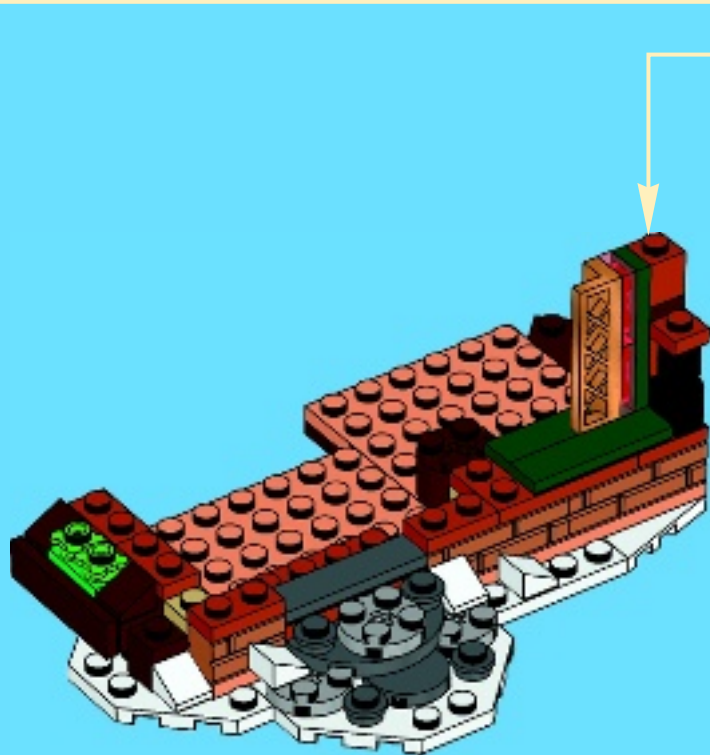
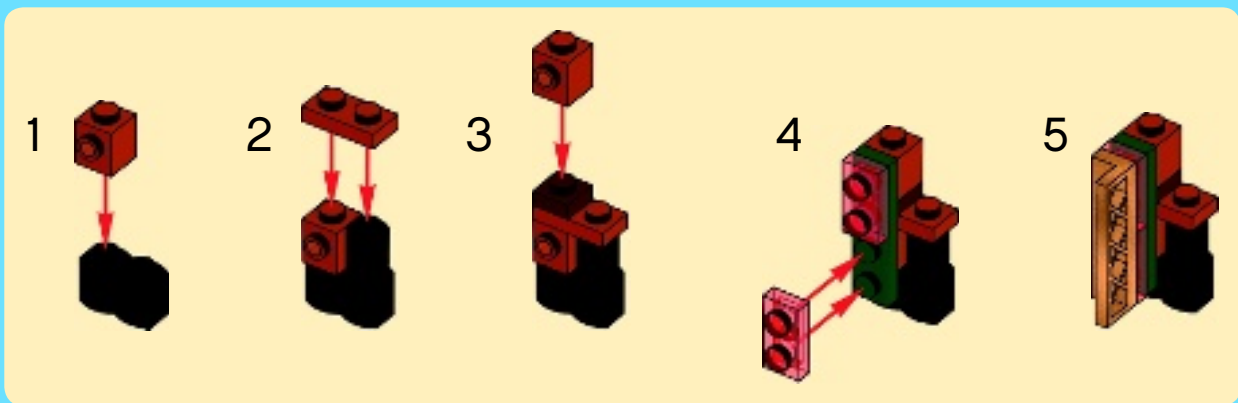

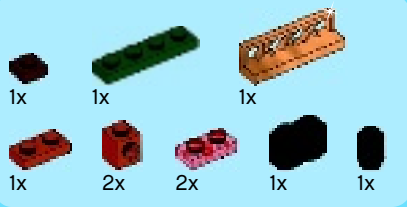

13

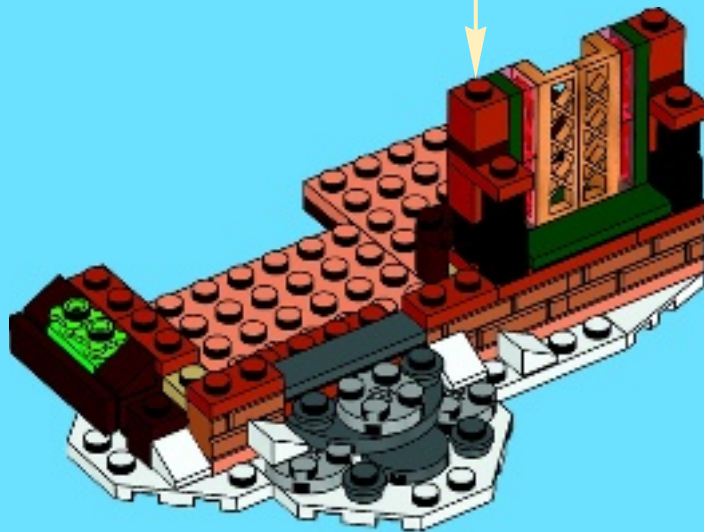
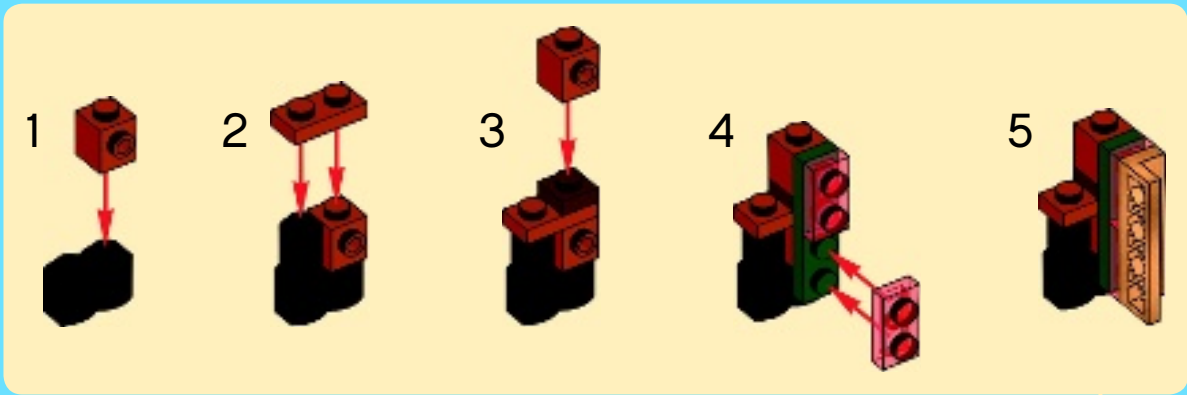



14

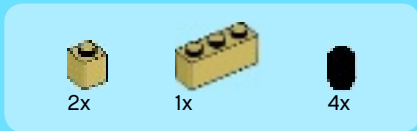
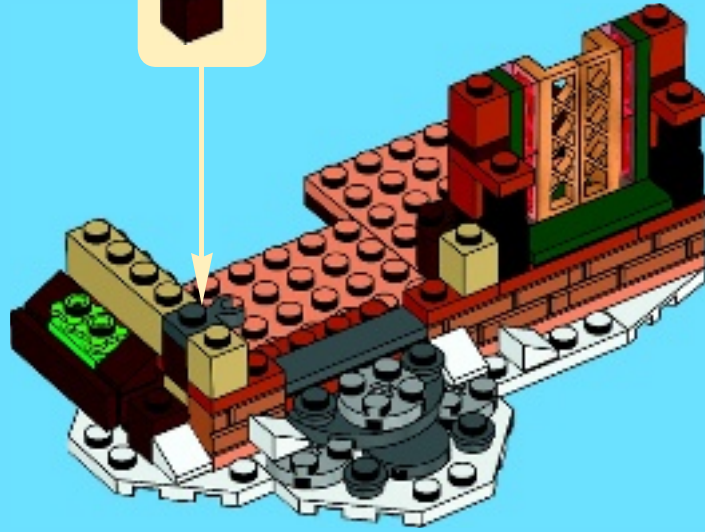

15

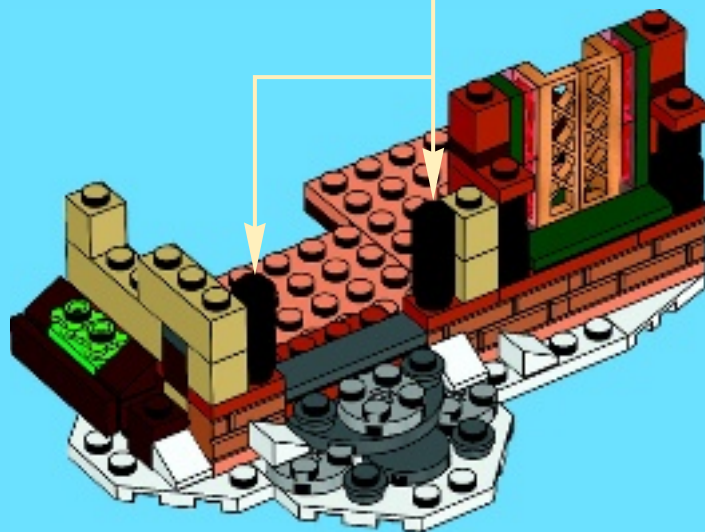

1x

1x

2x

1x

16

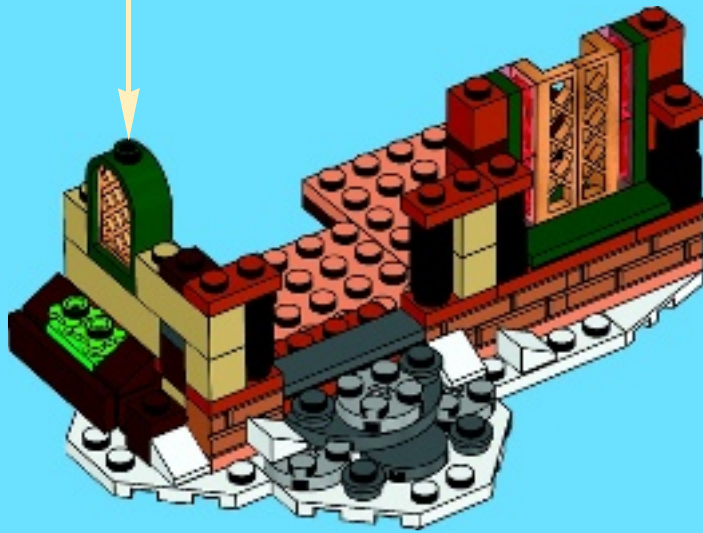

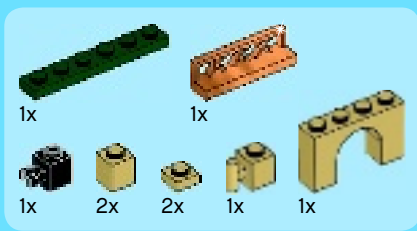

17

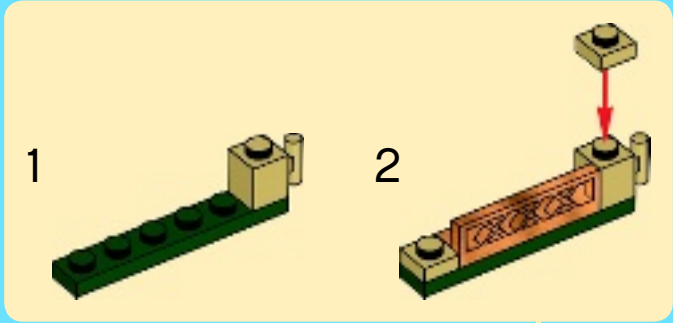

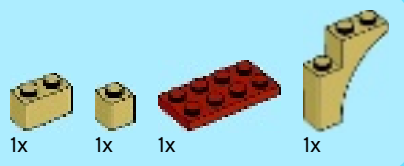

18

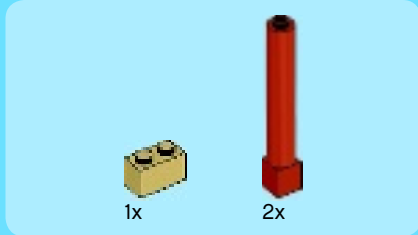

19

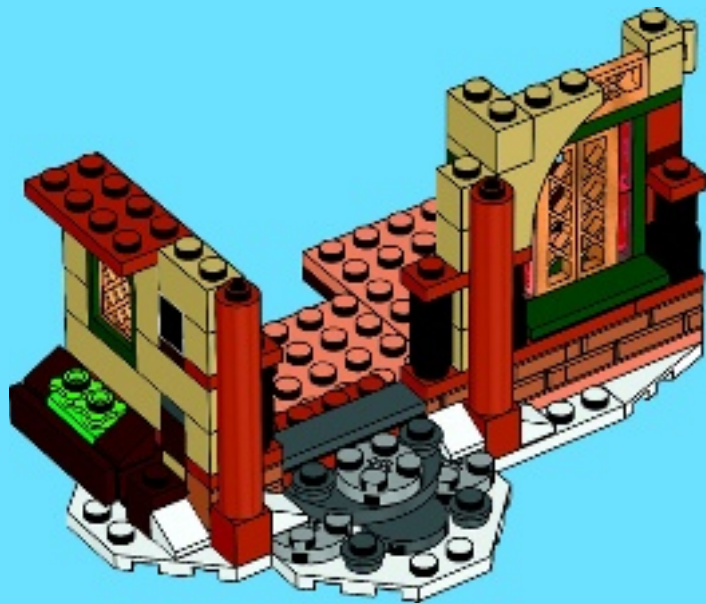

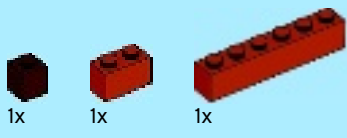

20

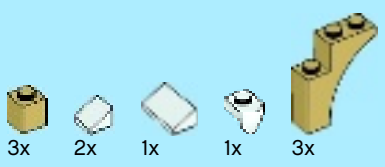

21

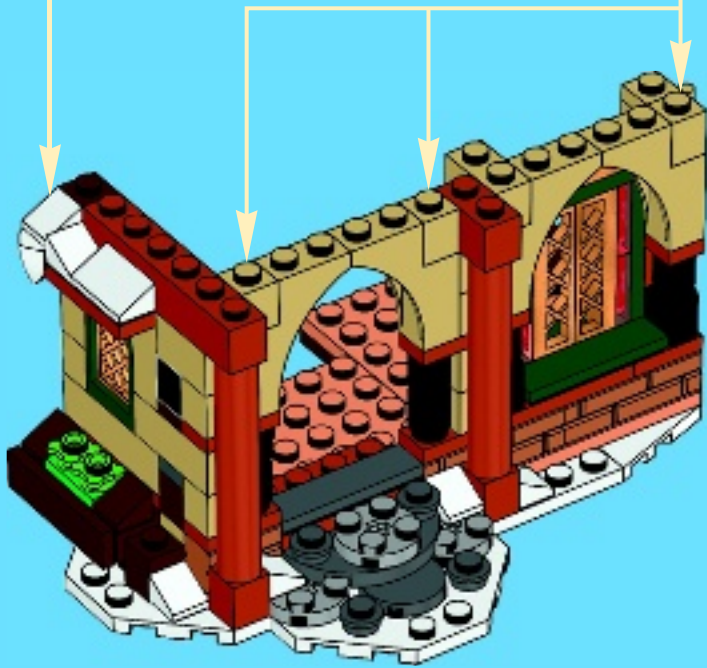
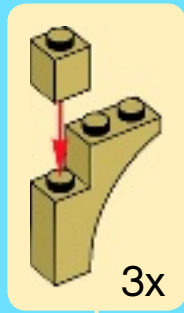
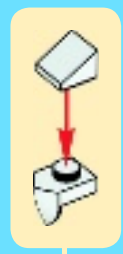

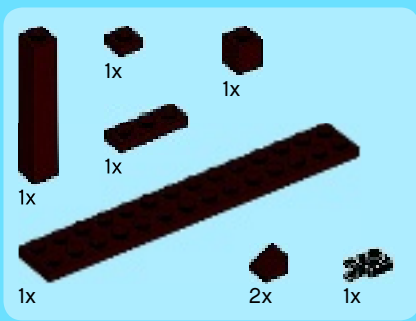

22

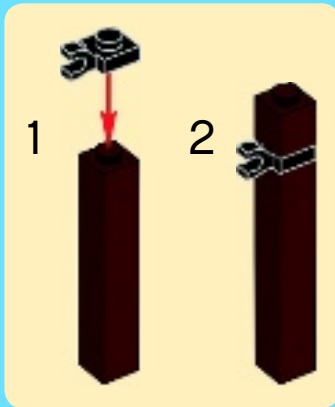

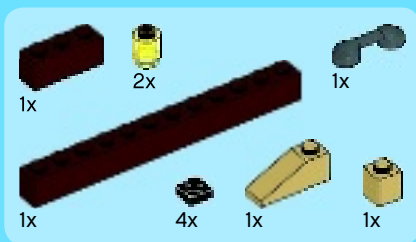

23

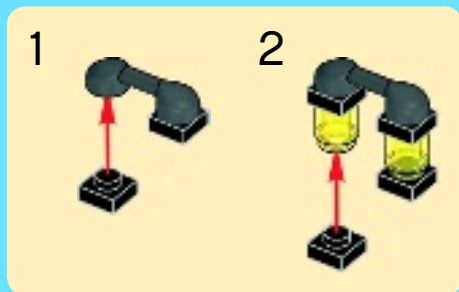

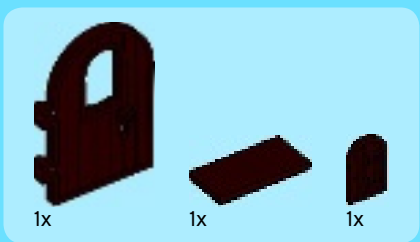

24

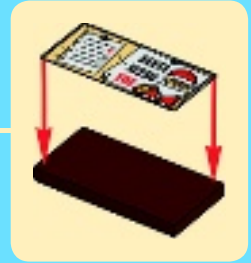

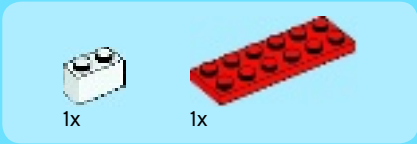

1

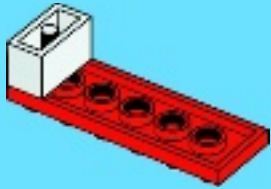

2

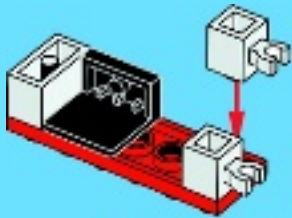

3

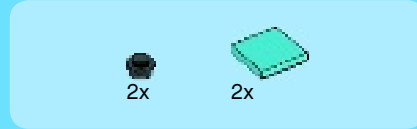
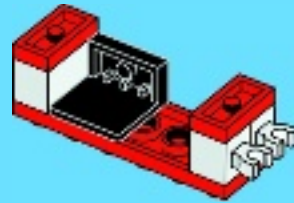

4

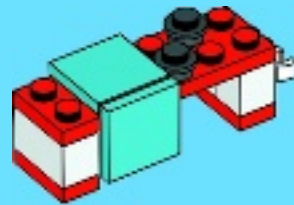



1x



1x



1x

5

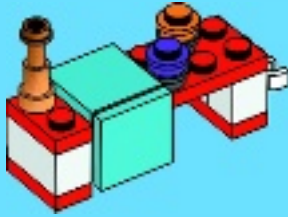

1x



1x



1x



2x

6

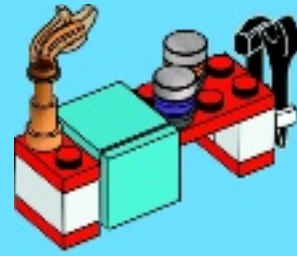

25





2x



1x



1x



1x

26



2x



1x



1x



1x

27





1x



2x

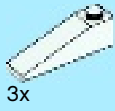

3x

28



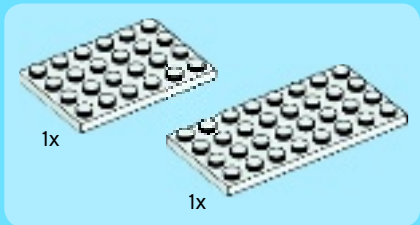

1

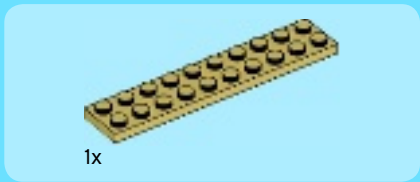
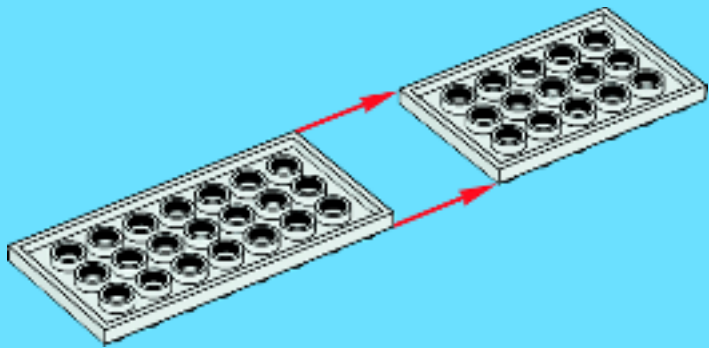

2

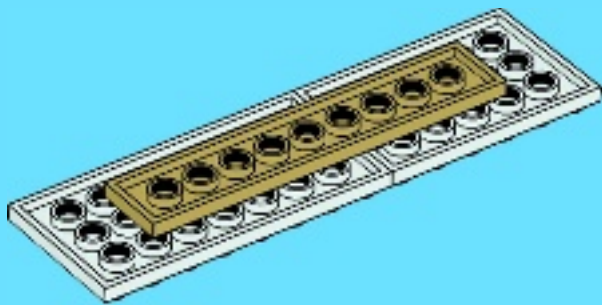



2x



2x

3

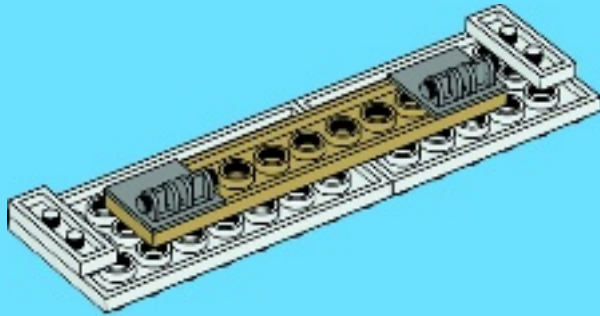

3x

1x



4

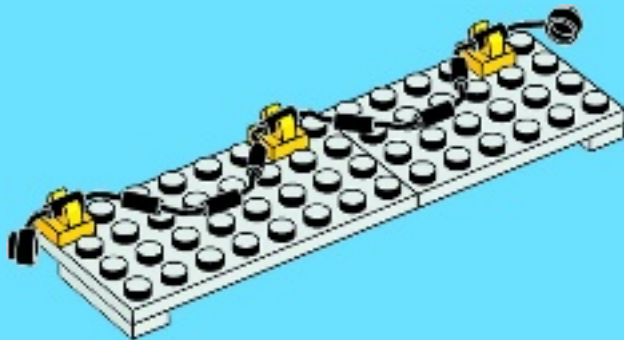

- 2x
- 2x
- 2x
- 2x
- 2x
- 6x

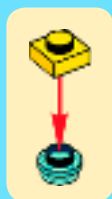
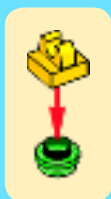

5



29





1x

30





1

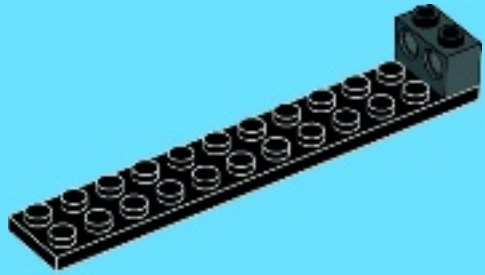

2

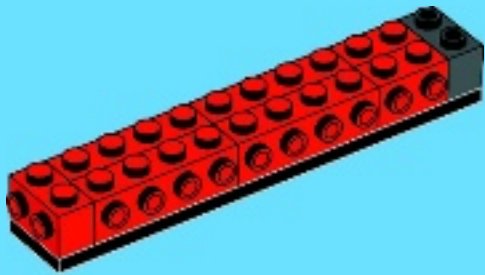



3

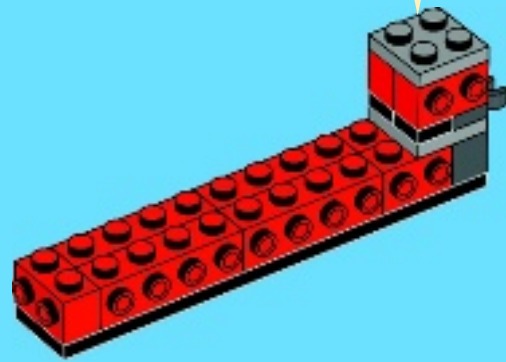
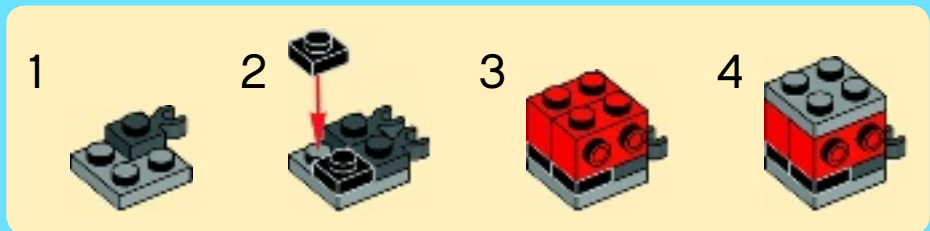

4

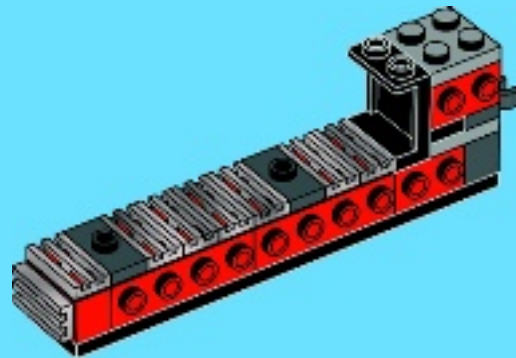

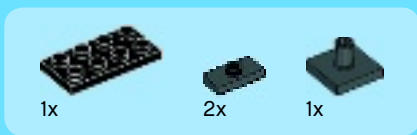

5

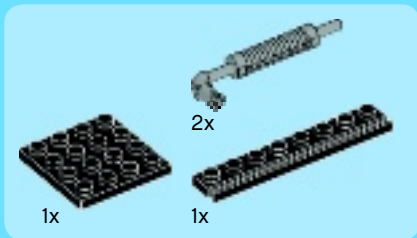
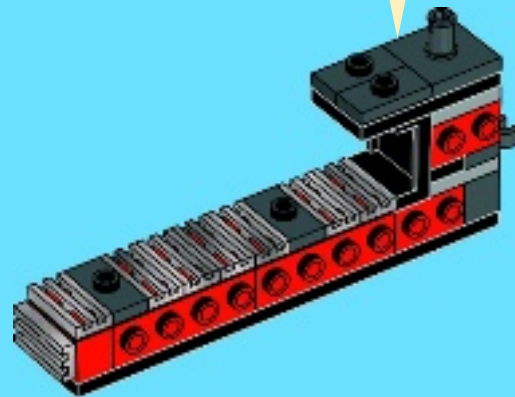
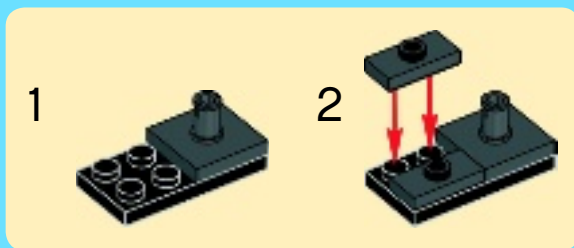

6

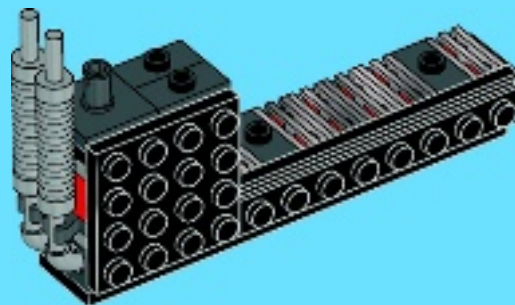



3x



2x



2x

7

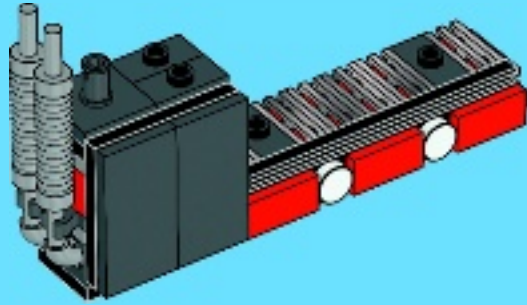

1x



1x

8

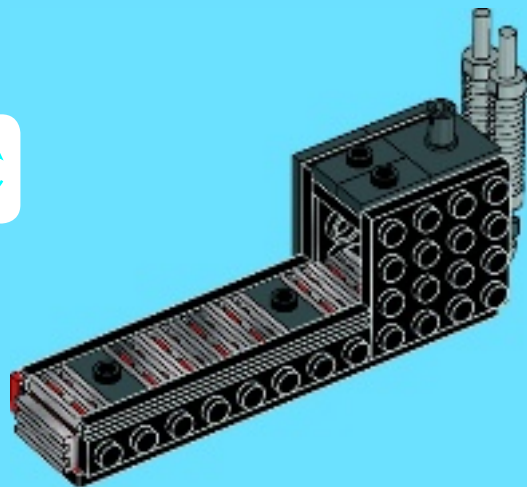



9

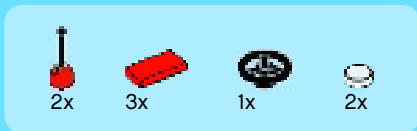
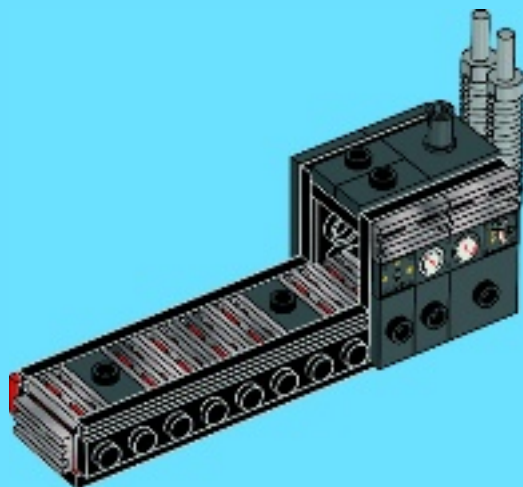

10

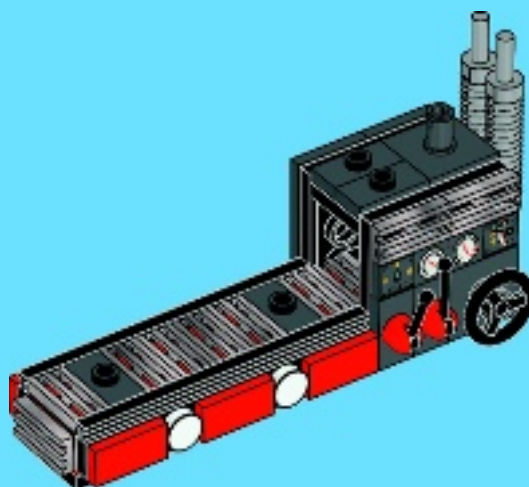



11

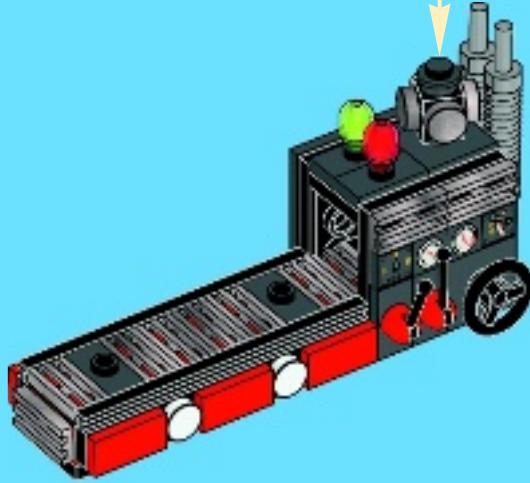
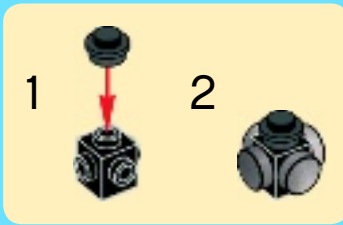

12

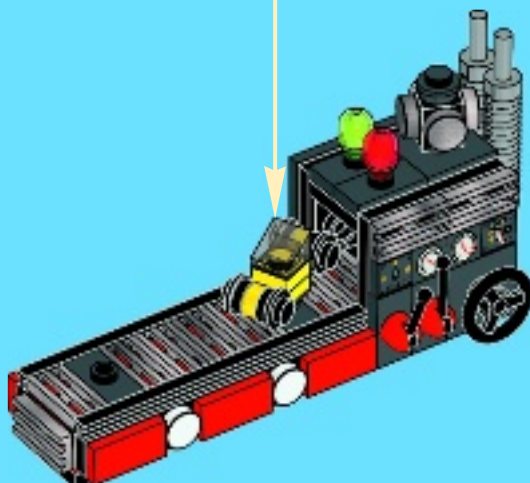

- 2x 
- 1x 
- 2x 
- 1x 
- 2x 

13

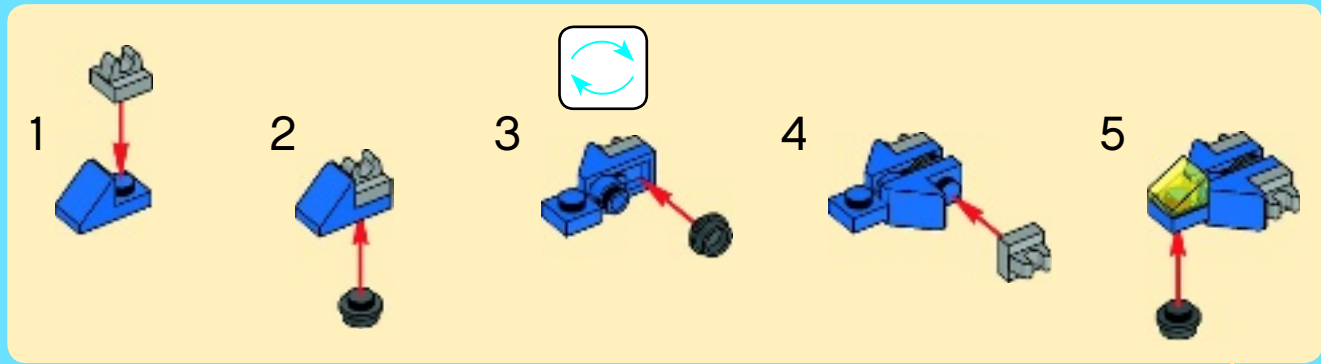

1. A grey 1x2 Technic brick with hole is placed on top of a blue 1x2 Technic brick with hole.

2. A black axle pin is inserted into the hole of the blue 1x2 Technic brick with hole.

3. A blue 1x2 Technic brick with hole is placed on top of the assembly. A circular arrow icon indicates a rotation. A black axle pin is inserted into the hole of the blue 1x2 Technic brick with hole.

4. A grey 1x2 Technic brick with hole is placed on top of the assembly.

5. A yellow 1x2 Technic brick with hole is placed on top of the assembly.

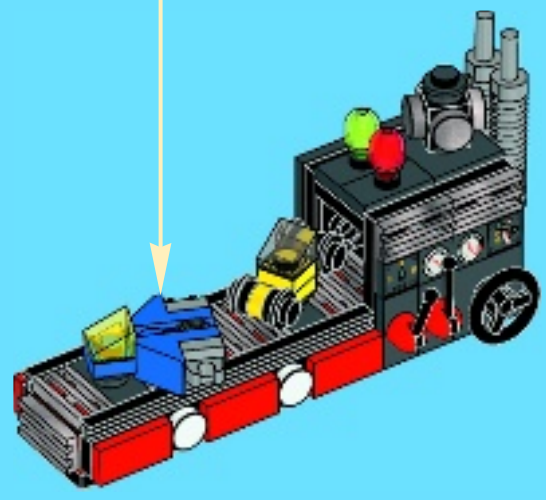



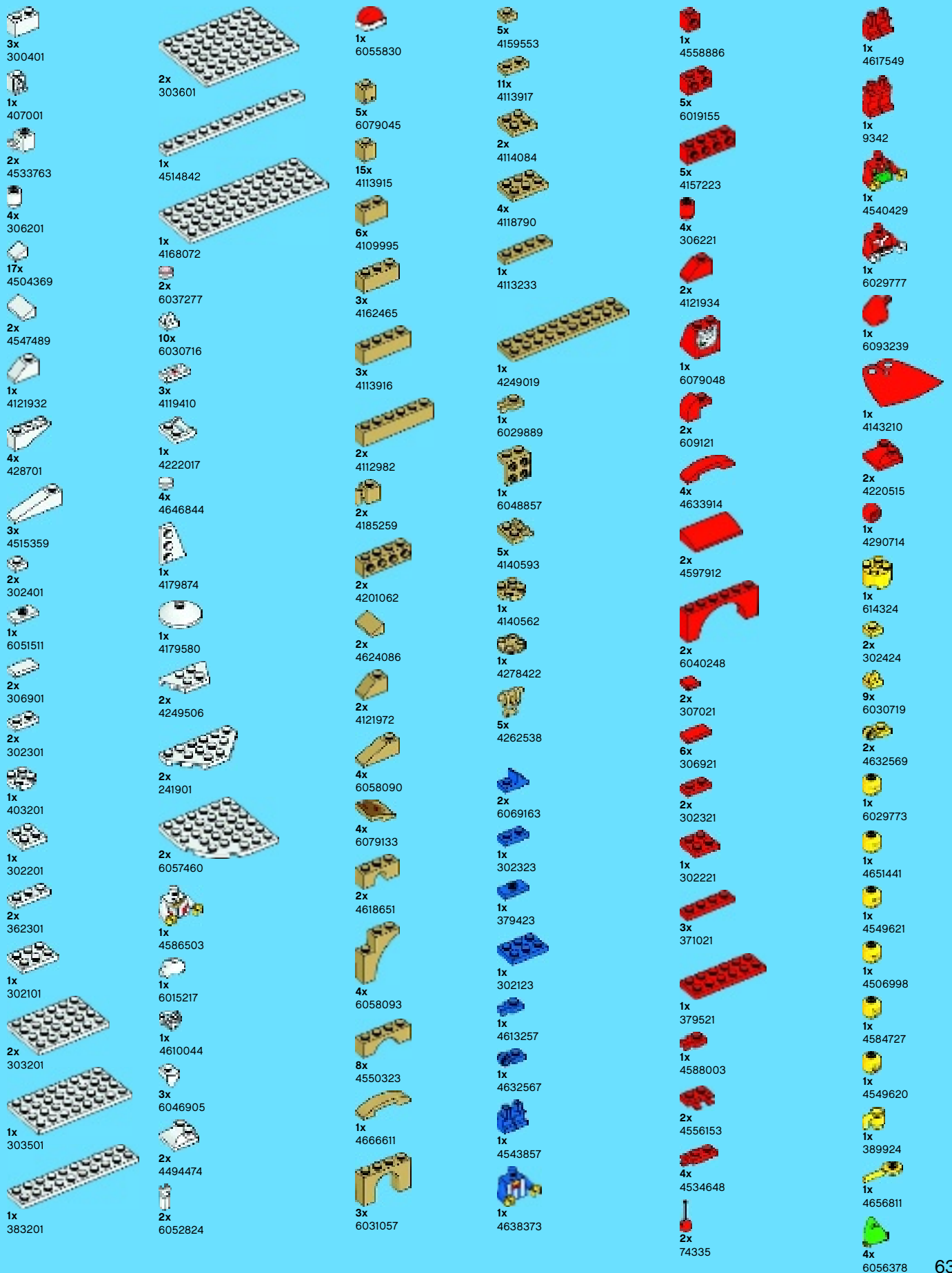

- 1x 4211220
- 1x 4211193
- 2x 4222627
- 2x 4221590
- 2x 4216945
- 1x 4585337
- 1x 6058247
- 1x 6004996
- 2x 6030720
- 4x 6066142
- 16x 4216581
- 1x 4211283
- 1x 4224732
- 1x 4624507
- 2x 4561915
- 8x 6006740
- 1x 6022038

- 2x 4211389
- 4x 4211388
- 1x 4211387
- 3x 4211349
- 1x 4211393
- 1x 6037399
- 7x 4521921
- 1x 4211436
- 2x 6034676
- 1x 4211435
- 1x 4211399
- 4x 4211398
- 3x 4211414
- 2x 4211397
- 2x 4211445
- 1x 4211452
- 2x 6030711
- 1x 4594238
- 1x 4654577
- 2x 6070731

- 2x 4650260
- 2x 4211525
- 5x 4211475
- 2x 6044706
- 4x 4211881
- 2x 4211090
- 5x 6000311
- 1x 4211085
- 6x 4211044
- 2x 4624186
- 1x 4558959
- 1x 4210762
- 1x 4211096
- 2x 4210702
- 6x 4211119
- 2x 4211094
- 5x 4565322
- 2x 4211043
- 2x 4211053
- 2x 4560184

- 3x 4587212
- 6x 4543086
- 1x 4211129
- 1x 6020825
- 10x 4210633
- 2x 4620079
- 1x 4528323
- 1x 4210676
- 1x 4566522
- 1x 4490599
- 9x 4523160
- 5x 4585493
- 19x 4523159
- 4x 4541895
- 2x 6060803
- 3x 4536675
- 4x 4600267
- 2x 4538126
- 4x 6003147
- 2x 4640843
- 6x 6069990

- 2x 4519970
- 6x 6022105
- 1x 4570481
- 4x 6057986
- 4x 4656783
- 4x 6055309
- 2x 6058135
- 1x 6040253
- 2x 6055384
- 10x 4619636
- 6x 4655241
- 1x 6031019
- 1x 6003008
- 2x 6060857
- 1x 4625032
- 1x 6022169
- 1x 6022033

Customer Service
Kundenservice
Service Consommateurs
Servicio Al Consumidor
LEGO.com/service or dial



: 00800 5346 5555
: 1-800-422-5346



CREATOR

10224

10232

10243



EXPERT



Join the LEGO® VIP Loyalty Program!

Nehmen Sie am LEGO® VIP-Programm teil!

Rejoignez le programme de fidélité LEGO® VIP !

Earn points towards valuable rewards every time you shop!



Get 1 VIP Point for every Dollar, Pound or Euro spent!*

*For other exchange rates, please see VIP.LEGO.com



For every 100 Points you earn, enjoy a \$5 / £5 / 5€ reward!

Sammeln Sie bei jedem Einkauf Punkte für wertvolle Prämien!



Erhalten Sie 1 VIP-Punkt für jeden Euro, Pfund oder Dollar, den Sie ausgeben!*

*Den Umrechnungsfaktor für andere Währungen erhalten Sie auf VIP.LEGO.com



Für 100 VIP-Punkte erhalten Sie eine Prämie von 5€ / £5 / 5\$!

Gagnez des points à chaque achat et obtenez de formidables récompenses !



Gagnez 1 point VIP pour chaque euro, livre ou dollar dépensé !*

*Pour d'autres taux de change, veuillez visiter VIP.LEGO.com



Par tranche de 100 points gagnés, bénéficiez d'une récompense de 5€ / 5 £ / 5 \$!

Redeem your rewards in LEGO Stores and shop.LEGO.com.

Lösen Sie Ihre Prämien in den LEGO Stores und auf LEGO.com/shop ein.

Utilisez vos récompenses dans les LEGO Stores et sur LEGO.com/shop.



- Enjoy early access to new LEGO products and promotions!
- Access special LEGO sets and goodies not available for anyone else!

Plus much, much more!

- Kaufen Sie neue exklusive LEGO Produkte, noch vor dem eigentlichen Verkaufsstart!
- Erhalten Sie Zugang zu besonderen LEGO Sets und Vorteilen, die es nur für LEGO VIPs gibt!

Und vieles mehr!

- Bénéficiez d'un accès en avant-première à des nouveautés et promotions LEGO !
- Accédez à des cadeaux et ensembles LEGO spéciaux réservés aux membres !

Et bien d'autres choses encore !

Visit VIP.LEGO.com for more information!

Besuchen Sie VIP.LEGO.com für weitere Informationen!

Rendez-vous sur VIP.LEGO.com pour en savoir plus !



WIN

GO TO WWW.LEGO.COM/PRODUCTFEEDBACK
AND GIVE US YOUR SHORT **FEEDBACK**
ABOUT THIS LEGO® SET FOR A CHANCE
TO WIN A COOL LEGO PRIZE.



LEGO.com/productfeedback



GEWINNE

Erzähle uns auf
www.LEGO.com/productfeedback

etwas über die Erfahrungen, die du
mit diesem LEGO® Set gemacht hast,
und sichere dir die Chance auf einen
coolen LEGO Preis!



GAGNE

Rends-toi sur
www.LEGO.com/productfeedback

et donne-nous quelques commen-
taires sur ce produit LEGO® pour avoir
une chance de gagner un prix LEGO !



GANAN

Visita
www.LEGO.com/productfeedback

y envíanos tu opinión acerca de este
set LEGO®. ¡Participarás en el sorteo
de un premio LEGO!



获取奖品

登录
www.LEGO.com/productfeedback

给出关于此乐高®套装的简短反馈，
就有机会获得炫酷乐高奖品



경품 당첨 기회

www.LEGO.com/productfeedback

페이지로 이동하여 이 레고® 세트에
대한 간략한 피드백을 보내 주시고
멋진 레고 경품을 탈 수 있는 기회도
잡으십시오



ЗАПОЛНИ АНКЕТУ И ПОЛУЧИ ПРИЗ

Перейди по ссылке
www.LEGO.com/productfeedback

ответь всего на несколько вопро-
сов об этом наборе LEGO®, и у тебя
появится шанс выиграть замеча-
тельный приз от компании LEGO.