



3



4



5

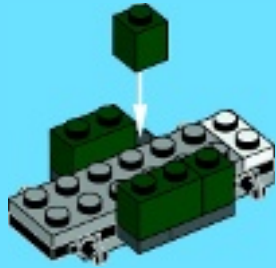

6



1



2

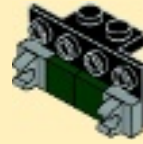

3



4



7

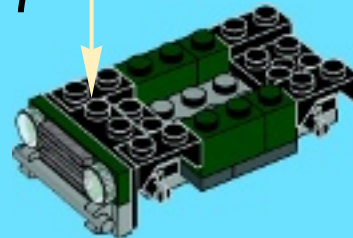

1



2

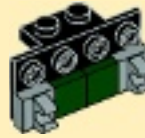

3

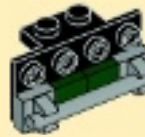

4

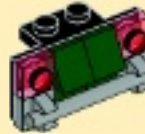

8



1

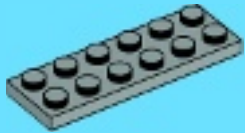

2



9

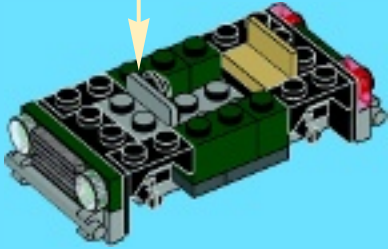
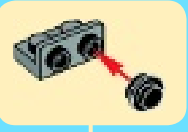

12

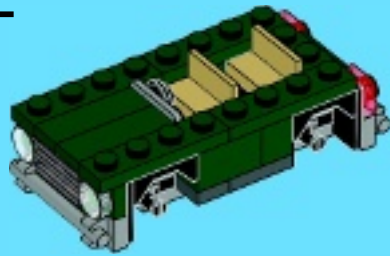

15

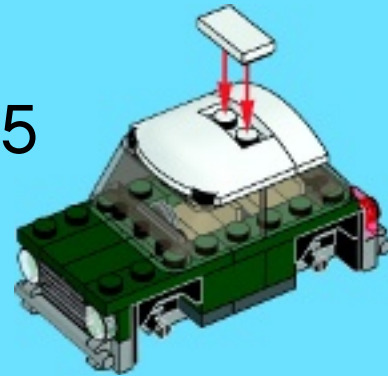

16



LEGO.com

6074399

LEGO and the LEGO logo are trademarks of the/sonnt des marques de commerce de/son marcas registradas de LEGO Group. ©2014 The LEGO Group.

10

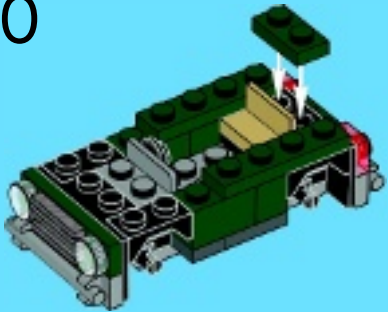

13

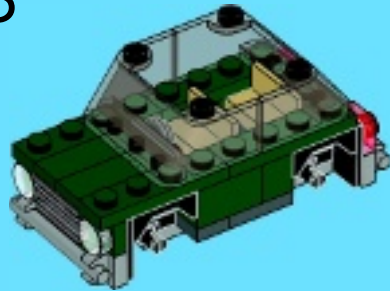

10242

11

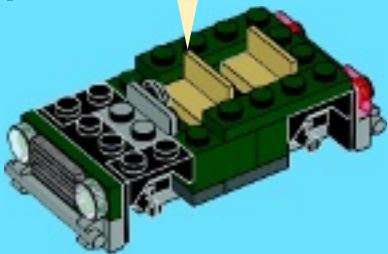
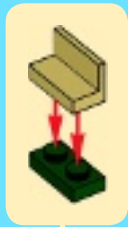

14

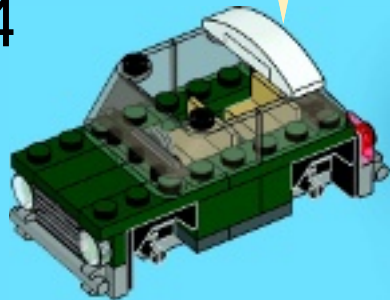
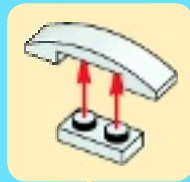

The MINI logo, the MINI word mark and model designation are trademarks of BMW and are used under license. Le logo MINI, la marque verbale et la désignation de modèle sont des marques déposées de BMW et sont utilisés sous licence. El logotipo de MINI, la marca textual MINI y la denominación del modelo son marcas comerciales de BMW usadas con autorización.