



Mixels

41511



1



2



3



4

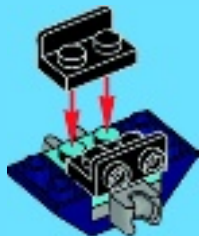

5



6



7

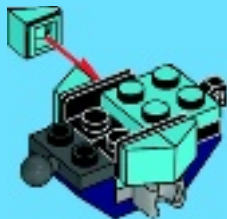

8



9



10

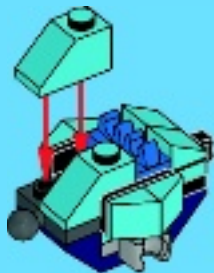

1

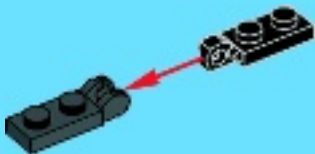

2

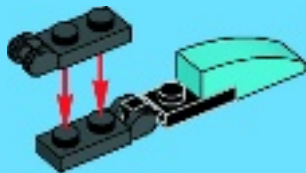

3

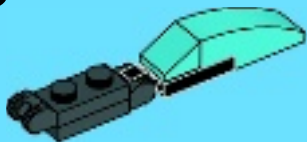

11

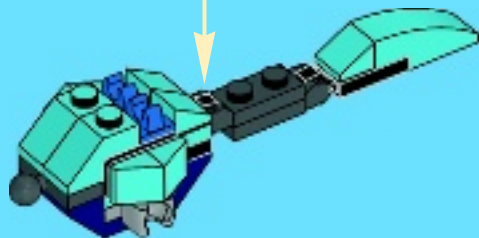



1



2



3

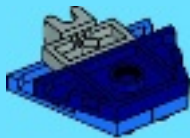



4



5



6



7



8



9



12

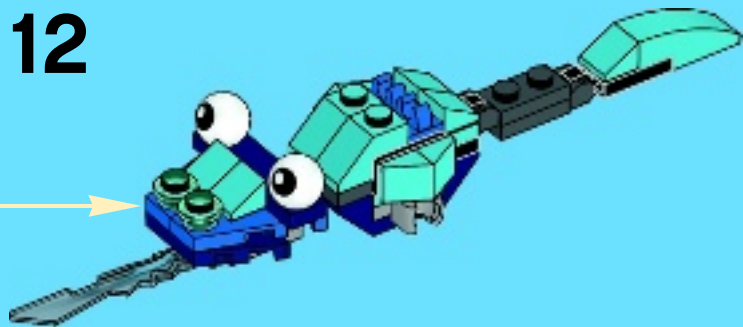

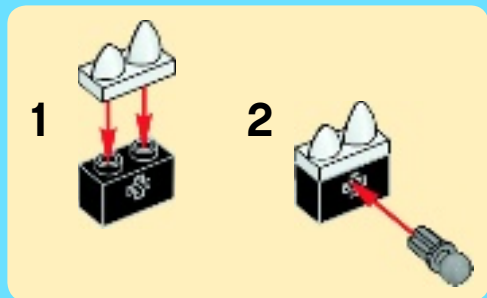

13

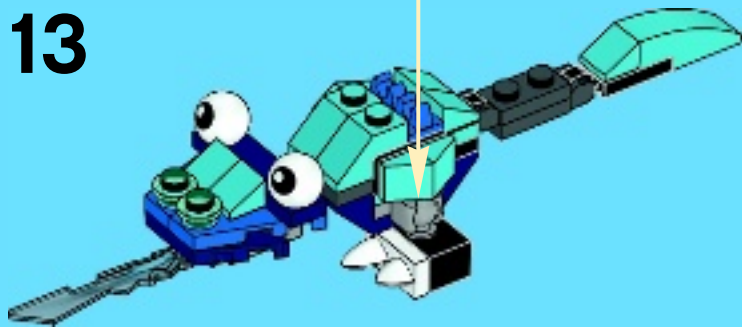

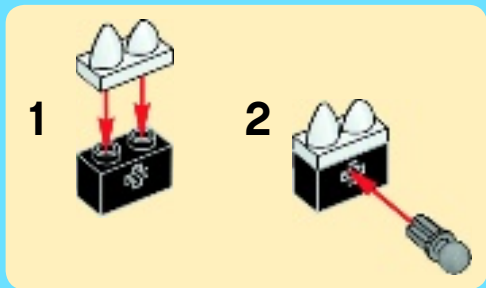

14

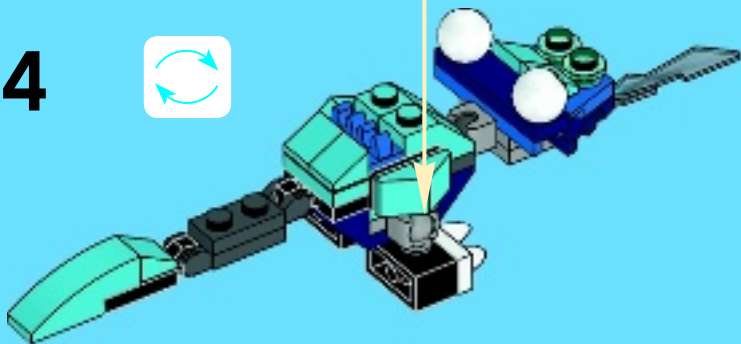

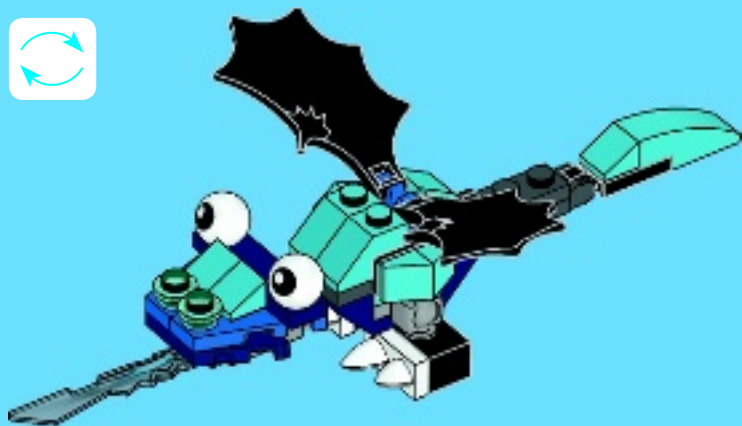



1x
4498156



1x
4498155



1x
4261784



1x
4185620



2x
4233487



2x
4619655



1x
6039479



2x
6030715



1x
4143005



1x
6036240



2x
6020193



2x
4277967



1x
6035598



2x
4210884



1x
4613335



1x
4183043



1x
6045988



2x
4625032



1x
6022109



Customer Service

Kundenservice

Service Consommateurs

Servicio Al Consumidor

LEGO.com/service or dial



00800 5346 5555 :



1-800-422-5346 :



2x
4211375



3x
6043656



9x
4619520



2x
4163917



2x
6056225



2x
6046384



**41509
SLUMBO**



**41511
FLURR**



**41510
LUNK**



**FROSTICONS
MAX!**



LEGO.com/mixels





Mixels



41500
FLAIN



41501
VULK



41502
ZORCH



41503
KRADER



41504
SEISMO



41505
SHUFF



41506
TESLO



41507
ZAPTOR



41508
VOLECTRO



41509
SLUMBO



41510
LUNK



41511
FLURR



41512
CHOMLY



41513
GOBBA



41514
JAWG



41515
KRAW



41516
TENTRO



41517
BALK



41518
GLOMP



41519
GLURT



41520
TORTZ



41521
FOOTI



41522
SCORPI



41523
HOOGI



41524
MESMO



41525
MAGNIFO



41526
WIZWUZ



LEGO.com/mixels



Mixels

CALLING ALL MIXELS

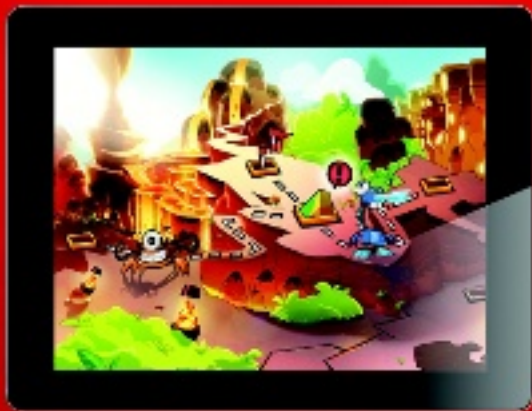

YOU CAN
BUY THE
GAME!



B1ZZA8D

IN GAME CODE!

Available on the
App Store

ANDROID APP ON
Google play

Apple, the Apple logo, iPad, iPhone and iPod touch are trademarks of Apple Inc., registered in the U.S. and other countries. App Store is a service mark of Apple Inc. Google Play is a trademark of Google Inc.



WIN!

Go to LEGO.com/productfeedback to fill out a survey for a chance to win a cool LEGO® Product.

No purchase necessary.

Open to all residents where not prohibited.



LEGO.com/productfeedback

GEWINNE!

Nimm an der Umfrage auf LEGO.com/productfeedback teil und hab die Chance ein cooles LEGO® Produkt zu gewinnen!

Die Teilnahme am Gewinnspiel führt zu keinerlei Kaufverpflichtungen. Teilnahme in allen nicht ausgeschlossenen Ländern möglich.

WIN!

Ga naar LEGO.com/productfeedback, vul een enquêteformulier in en maak kans op een cool LEGO® product.

Geen aankoopverplichting. Ledereen mag deelnemen, uitgezonderd ingezetenden van landen waar een enquêteverbod geldt.

GAGNE !

Visite LEGO.com/productfeedback pour répondre à un questionnaire et avoir une chance de gagner un produit LEGO® très cool !

Aucune obligation d'achat. Ouvert à tous les résidents des pays autorisés.

当てよう!

LEGO.com/productfeedback にアクセスして、アンケートにご記入ください。当選者にはレゴ®製品を差し上げます。

お買い上げの必要はありません。禁止されていない限り、すべての皆様にご利用いただけます。



6072664

LEGO, the LEGO logo and MIXELS are trademarks and/or copyrights of the LEGO Group.

©2014 The LEGO Group. All rights reserved.

TM & © 2014 Cartoon Network