



1



2



3

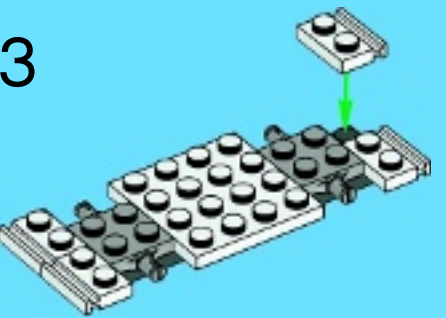

4

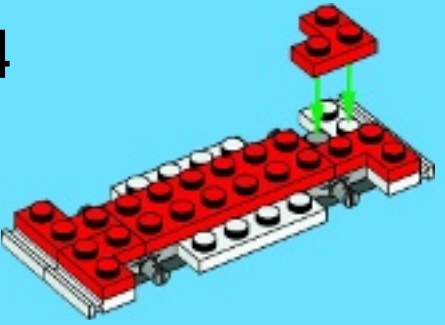

5

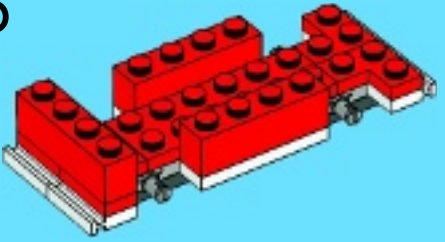

6

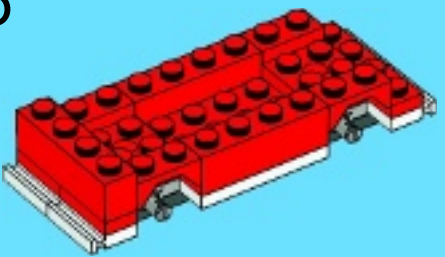

1



2

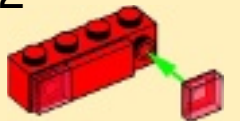

7

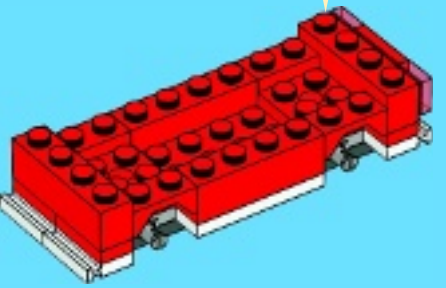

8

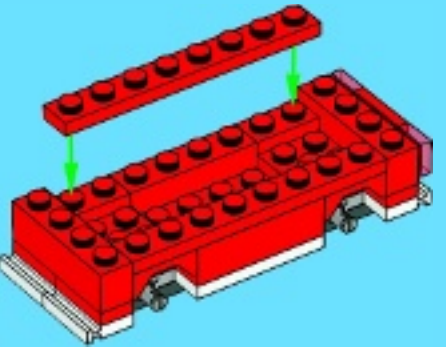

9

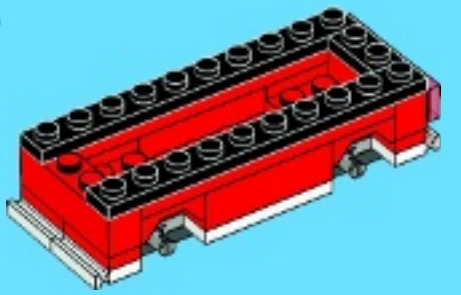

1



2



3



10

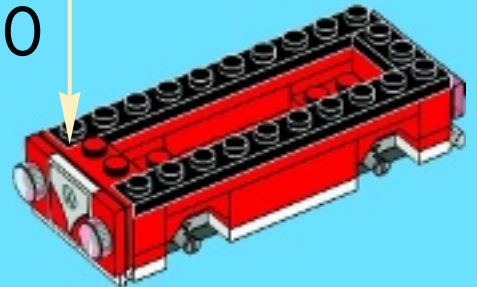



11

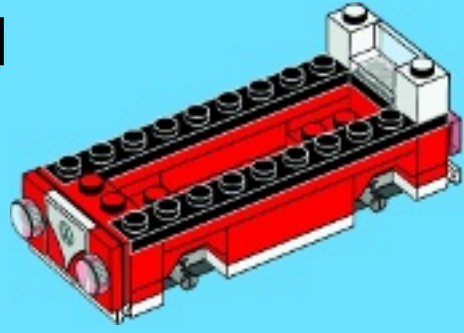

12

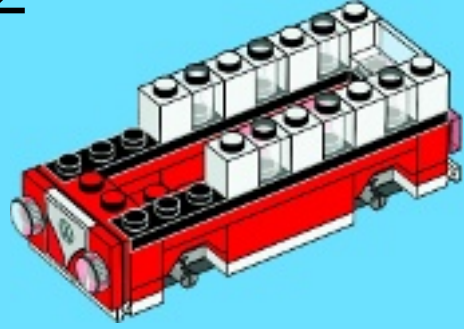

13

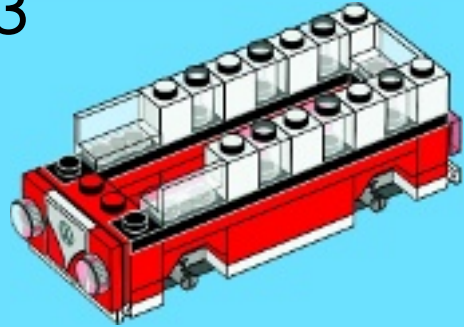

14

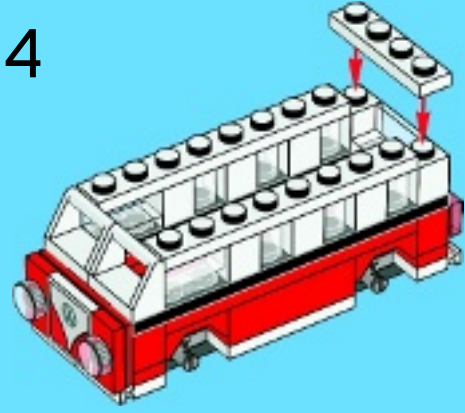

15



16



1

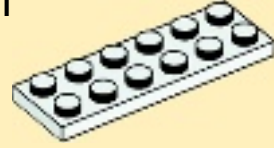

2

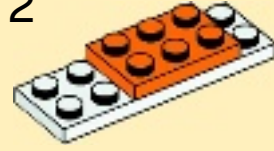

3



4



17



18



LEGO.com/service

LEGO and the LEGO logo are trademarks of the/son des marques de commerce de/son marcas registradas de LEGO Group. ©2013 The LEGO Group. 6050584



Officially licensed  
by Volkswagen



10220

OFFICIALLY LICENSED BY VOLKSWAGEN/SOUS LICENCE OFFICIELLE DE VOLKSWAGEN/CON LICENCIA OFICIAL DE VOLKSWAGEN.