

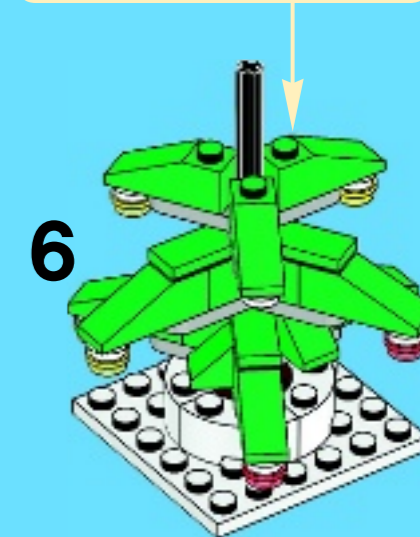

40058

6043503

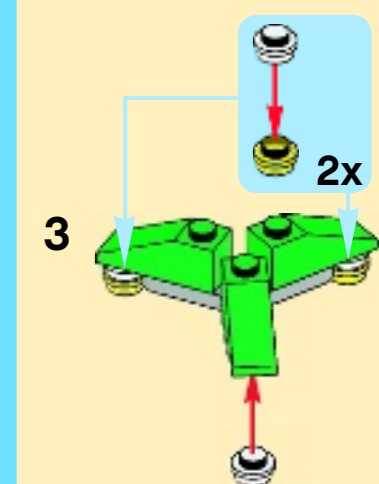
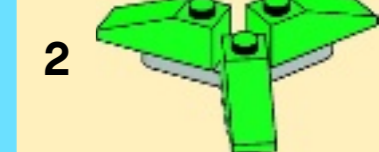
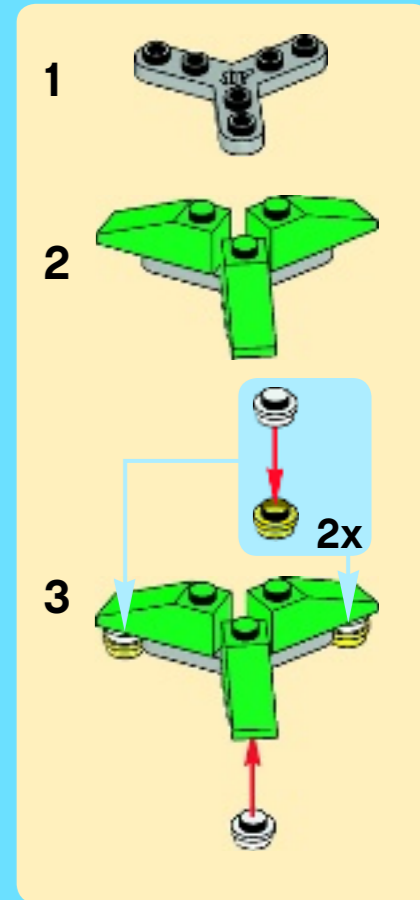
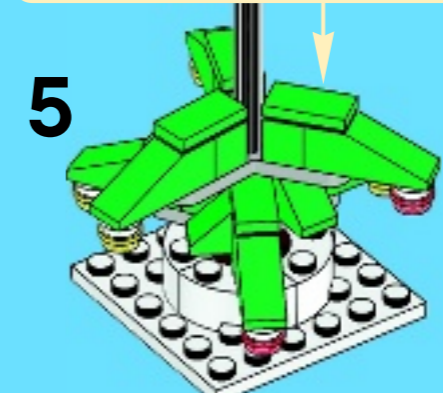
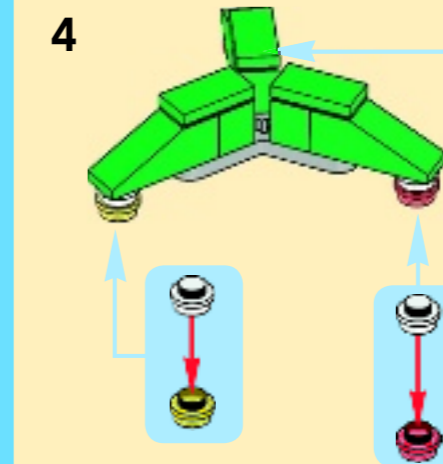
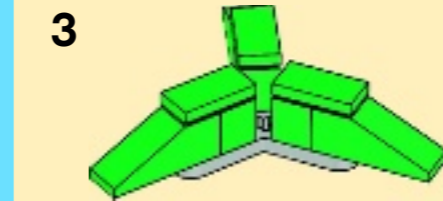
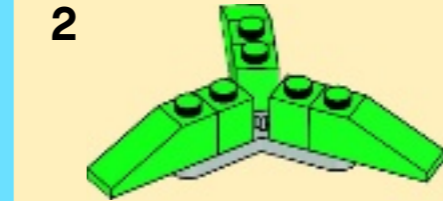
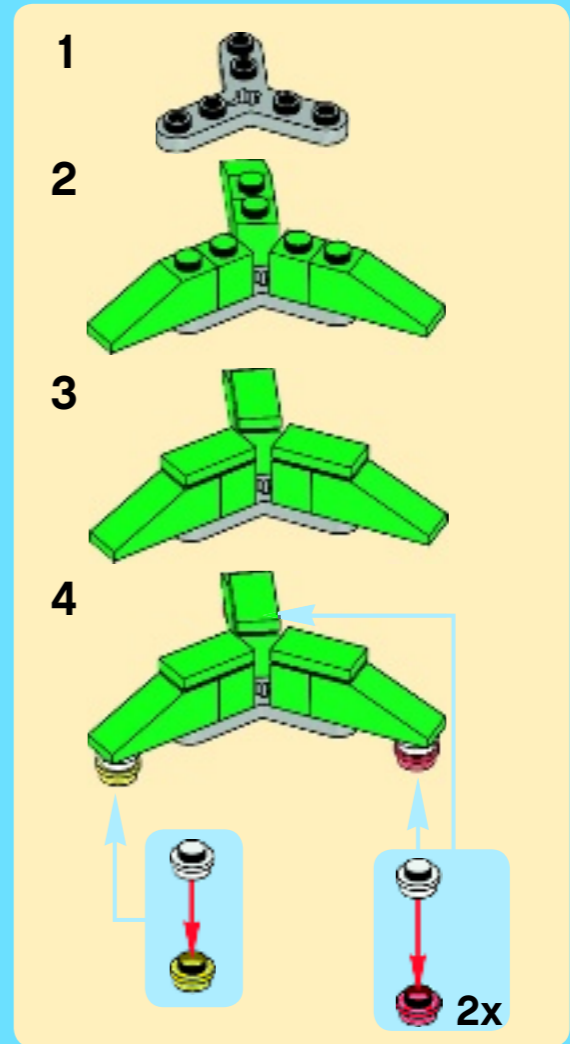
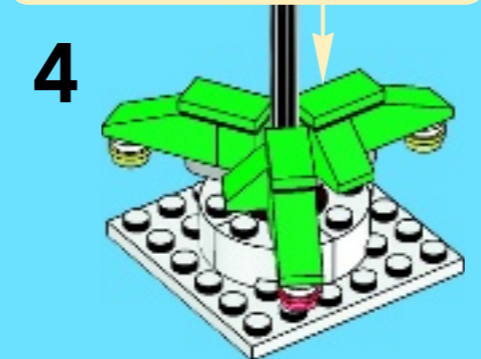
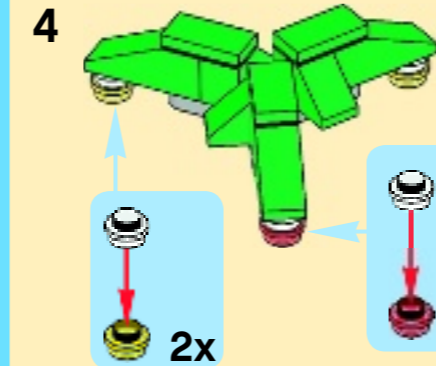
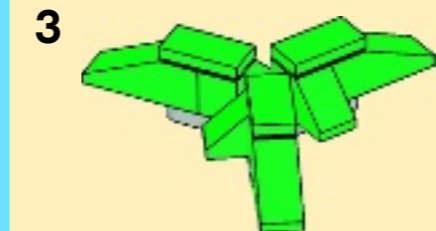
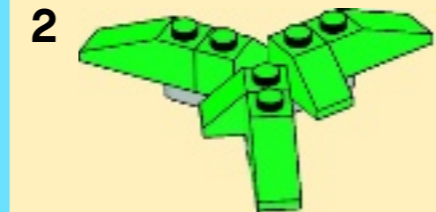
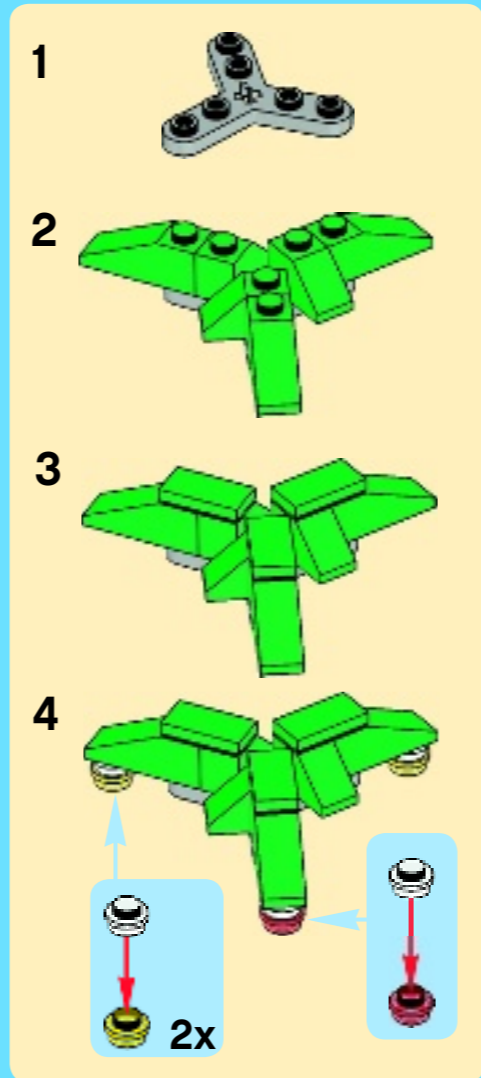
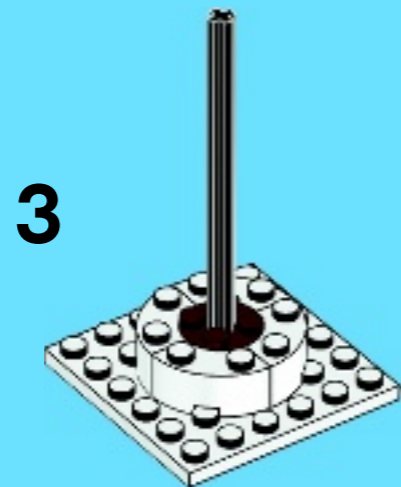

1

2

2x

3

7

8

1

2

3

1

2

1

2

3

4

5

9

1

2

3

4

1

2

3

4

5

	1x		1x		1x
4x 4262978		2x 4211190			
4x 4655241					
3x 4501970		2x 4211300			
1x 300324		1x 4211166		1x 4211158	
2x 4504381		2x 4227507		1x 4541496	
1x 4570043		1x 6016722		3x 300528	
1x 4584727		2x 302321		1x 4529239	
4x 4567449		2x 379421		6x 4121969	
3x 379401		1x 4617549		9x 4107637	
3x 302301		1x 4504380		6x 306928	
1x 4119410		1x 302423		1x 3000840	
14x 614101		1x 362323		6x 3005741	
1x 302101				6x 3005744	
				1x 4218642	
1x 4144012				2x 4164037	
1x 4523339				2x 4500125	
2x 614126				1x 4275821	
1x 373726					