



# STAR WARS



9515



1

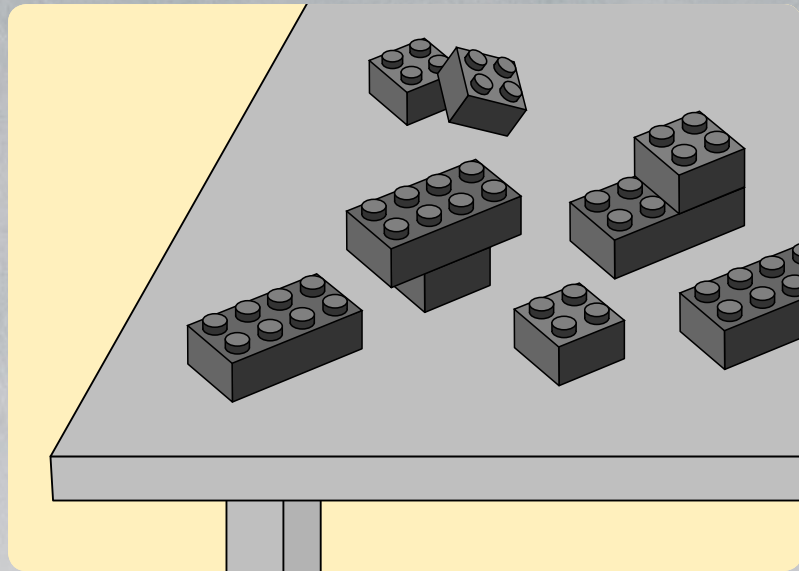
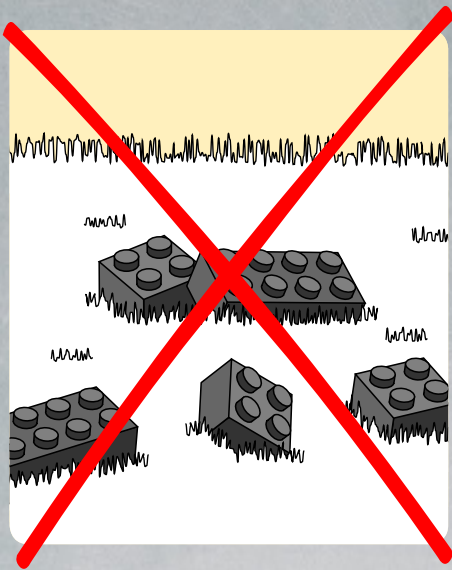

2

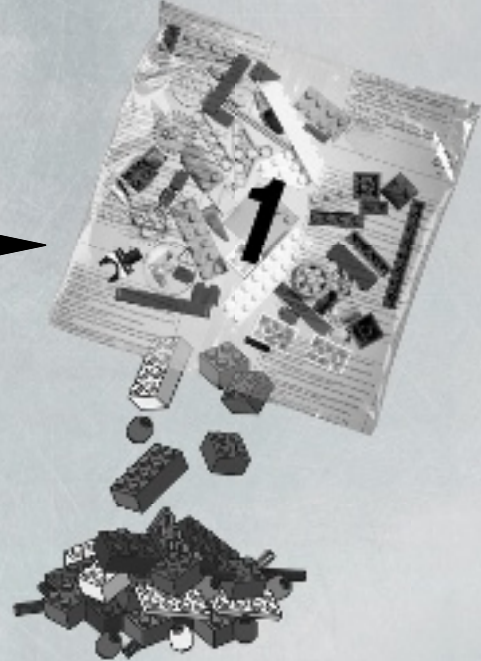

<http://lego.com/brickseparator>

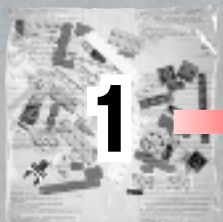

1

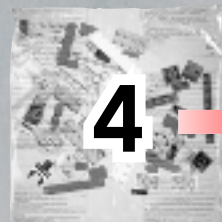

4

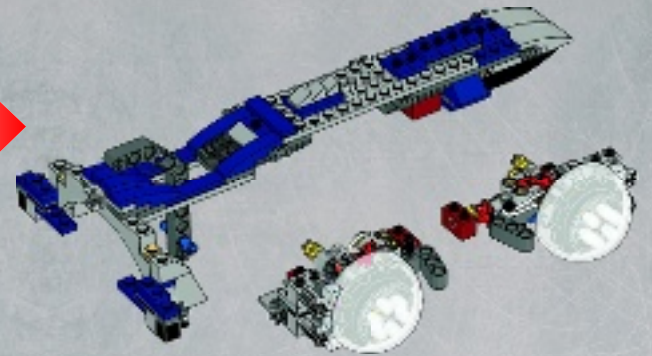
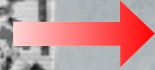

2

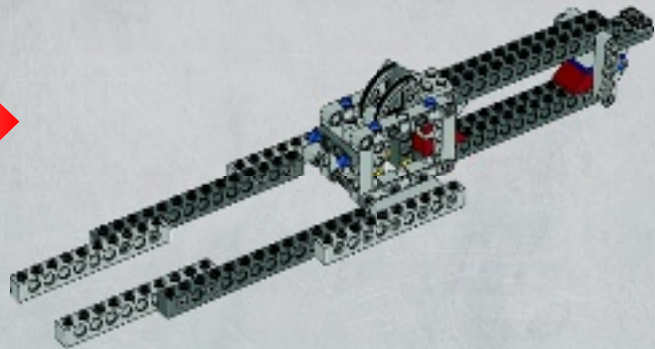
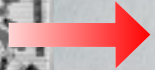

5

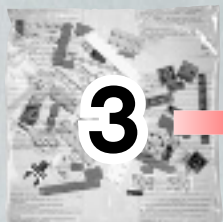
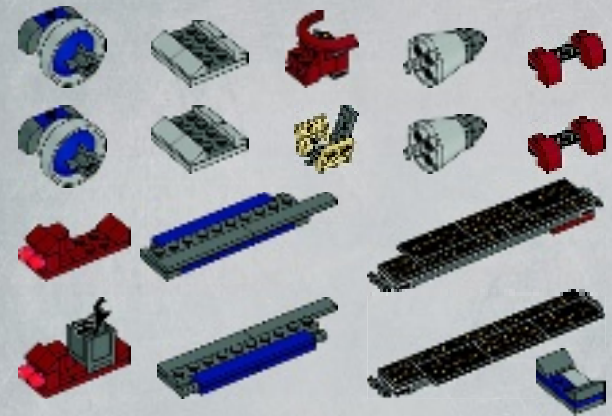
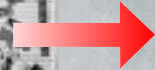

3

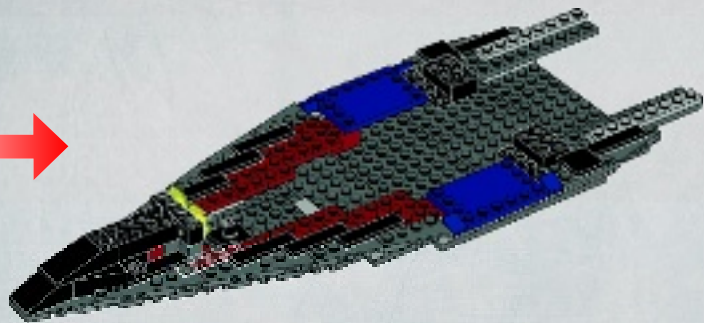

6

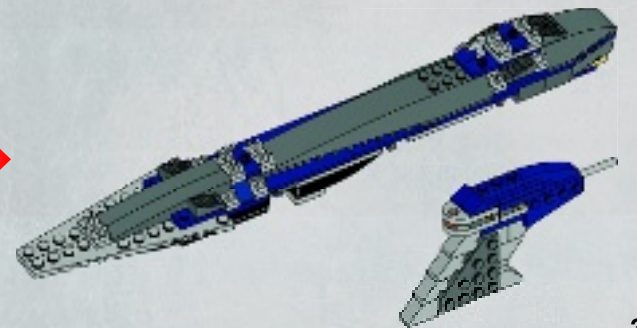

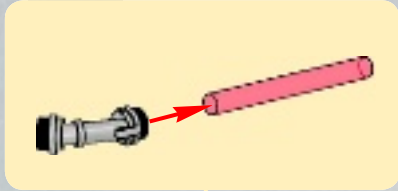
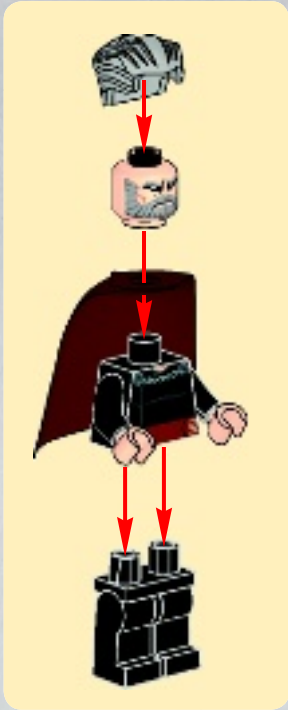
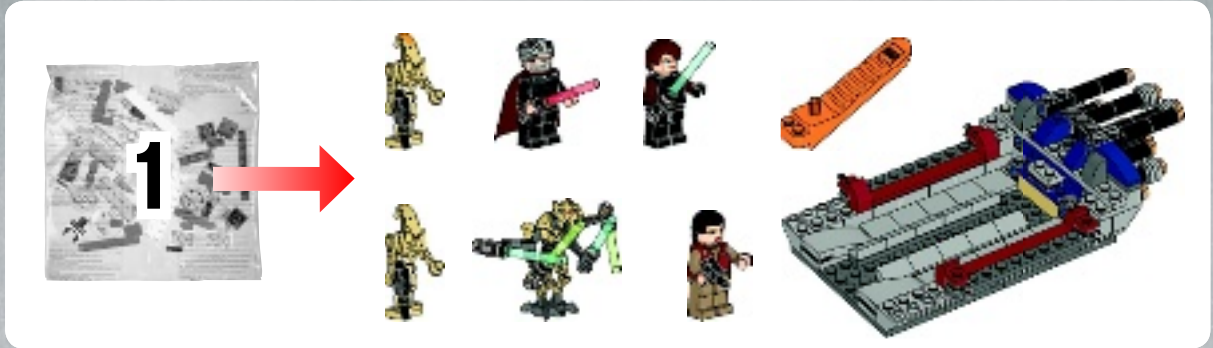
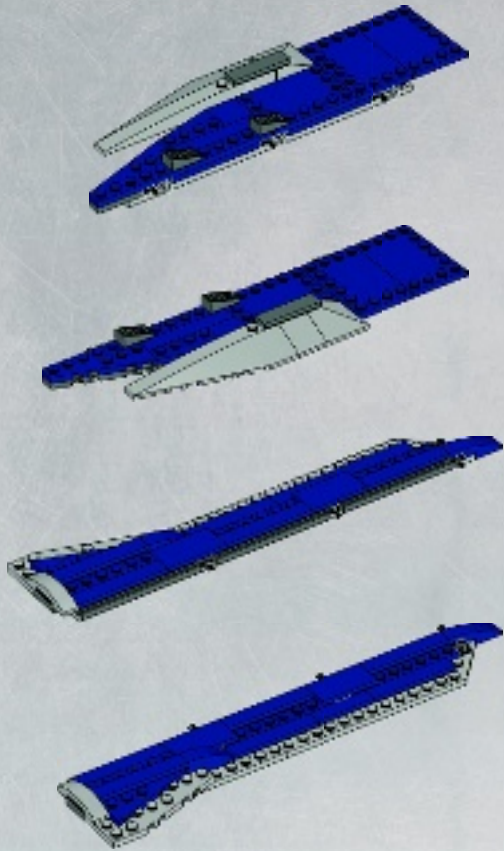

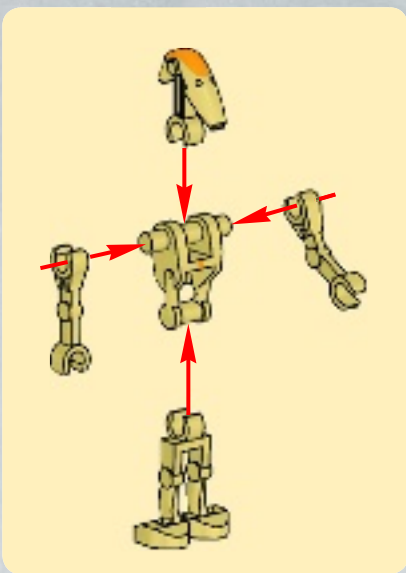
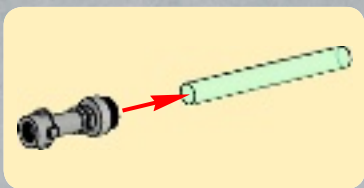

1



2

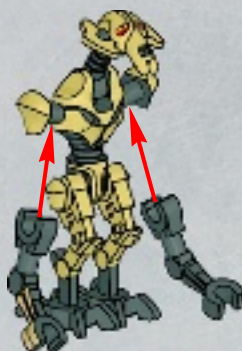

3

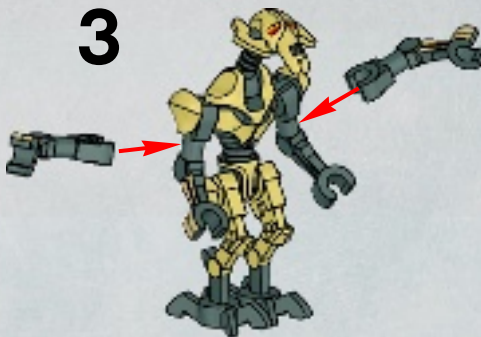

4

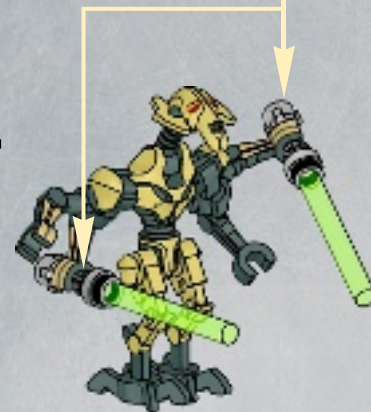
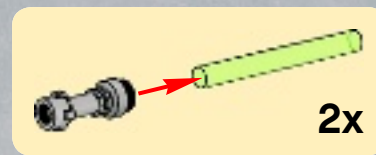

5

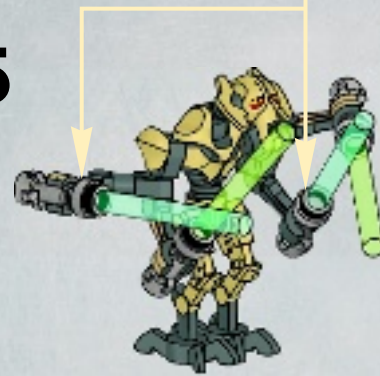
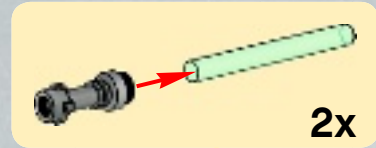



1x

1

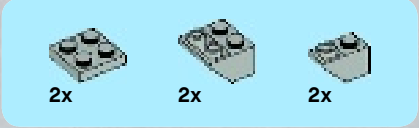

2x

2x

2x

2

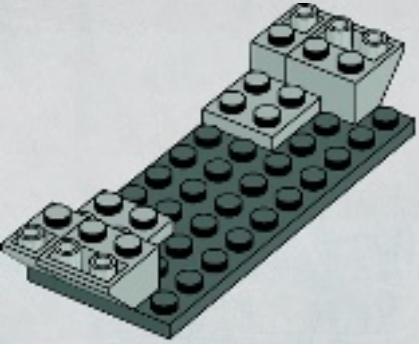

3x

2x

2x

3

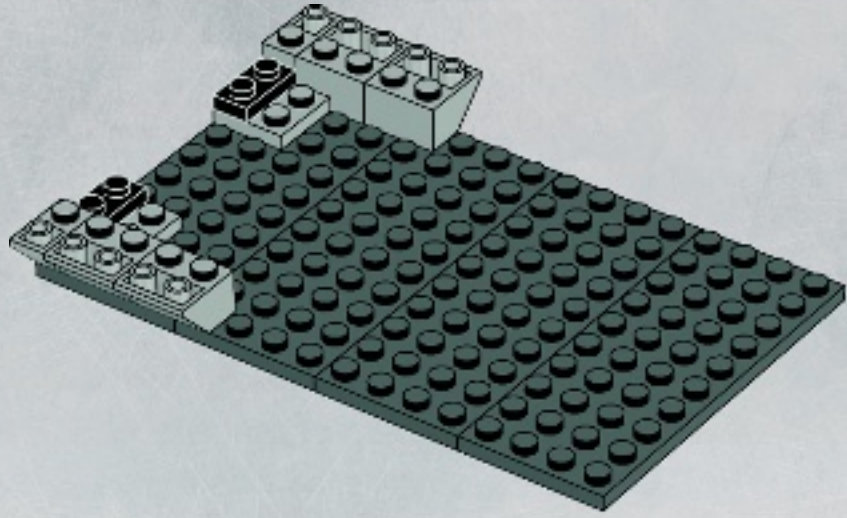

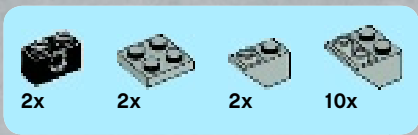

4

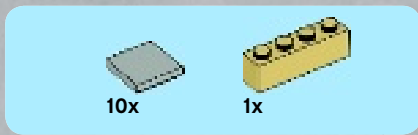
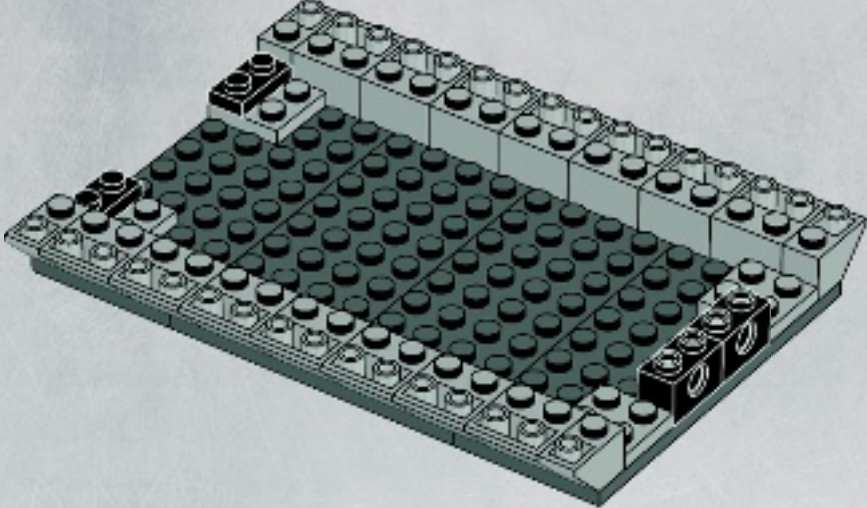

5

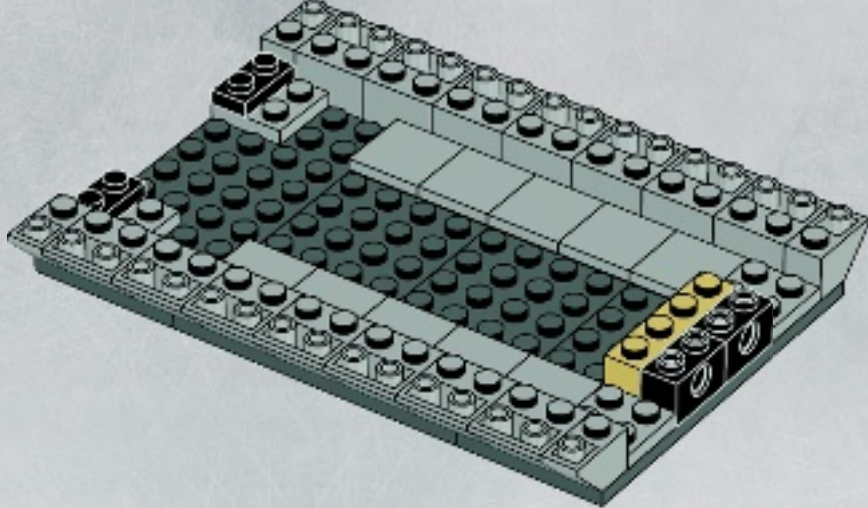



4x



2x



2x

# 6

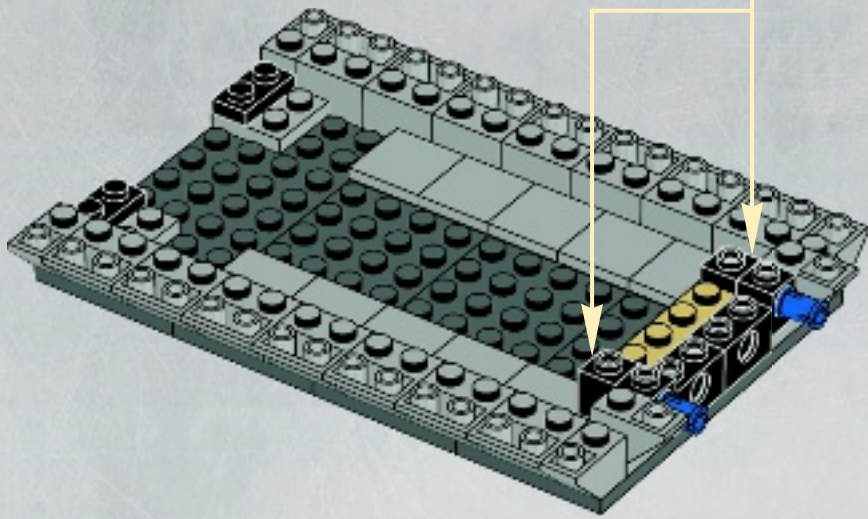
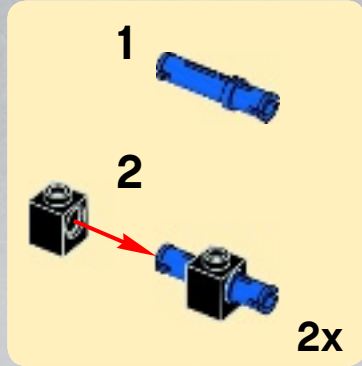

2x



2x



2x

# 7

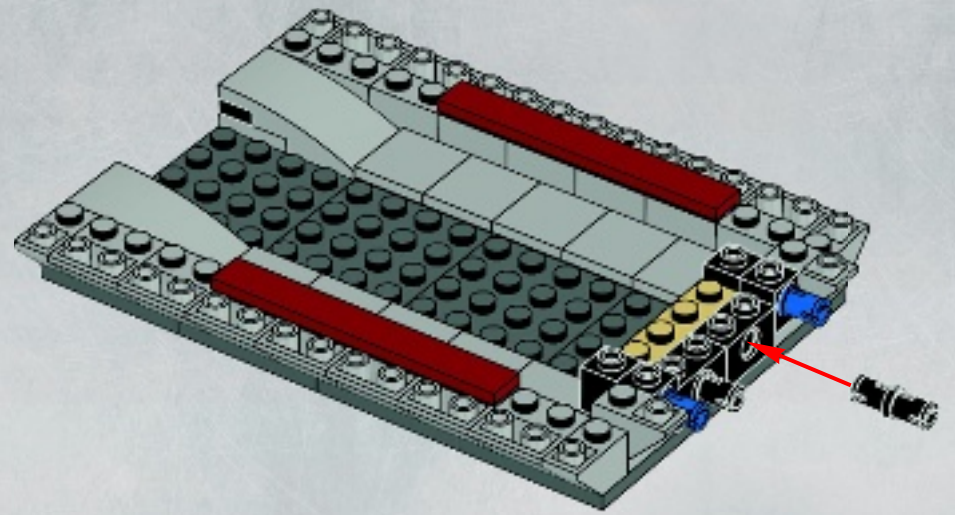



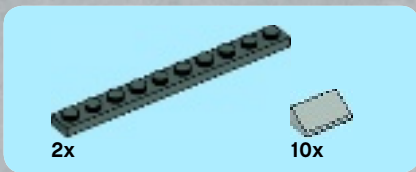

8

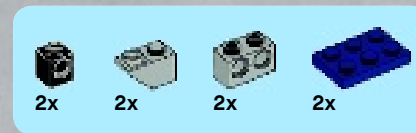
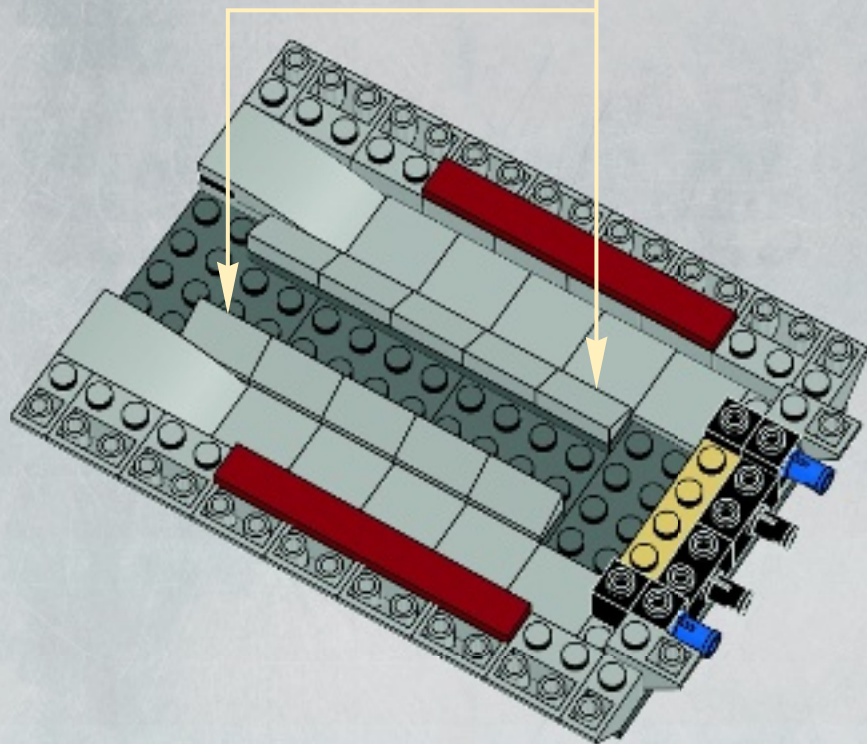
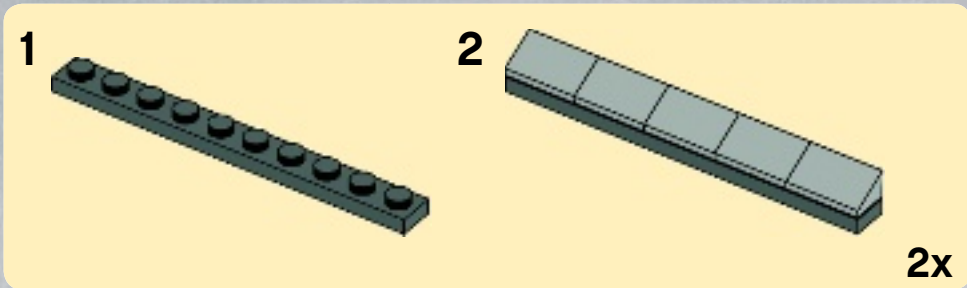

9

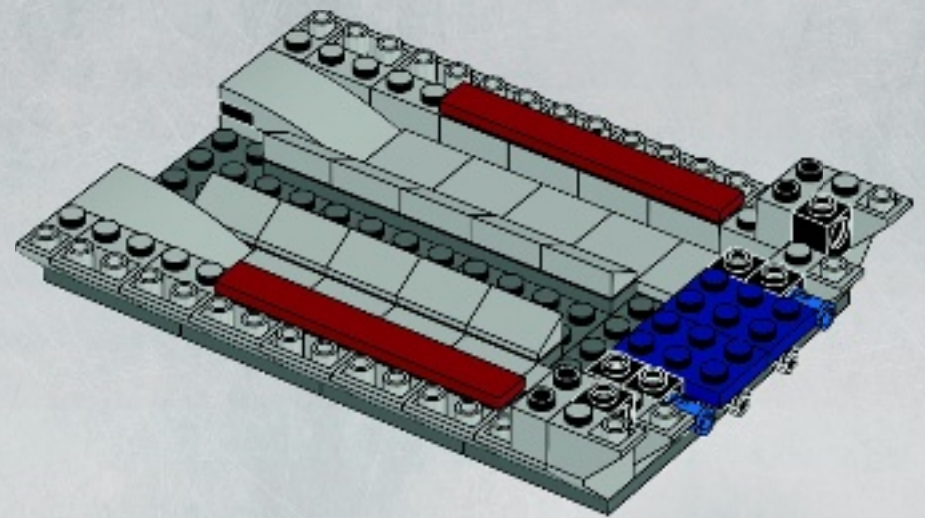

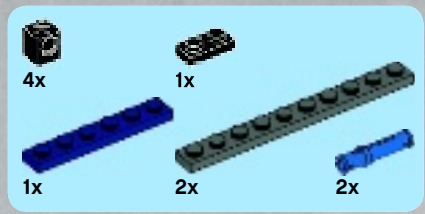

10

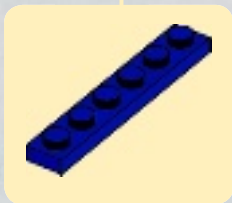
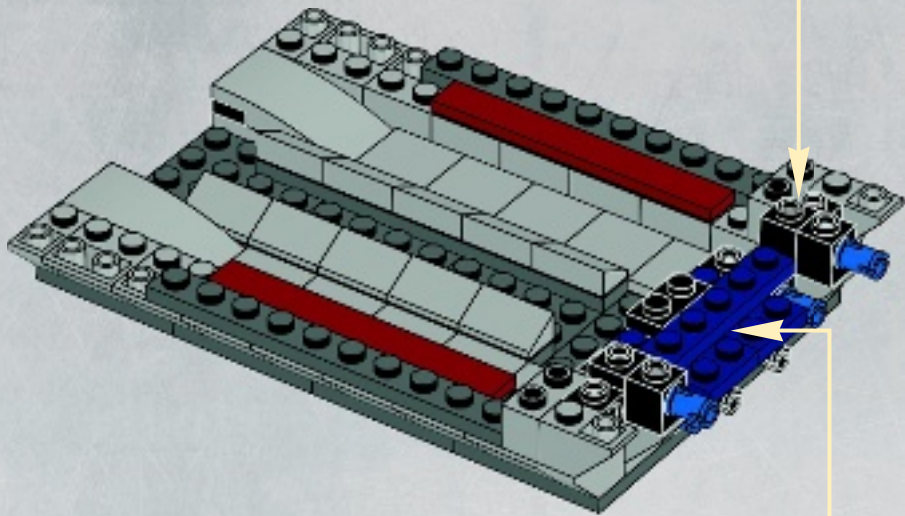
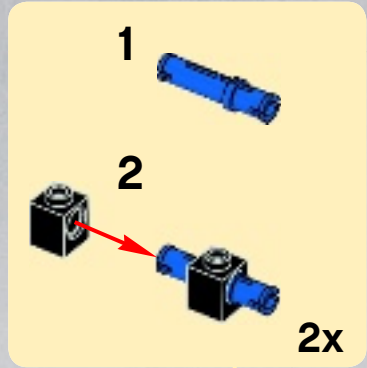

11

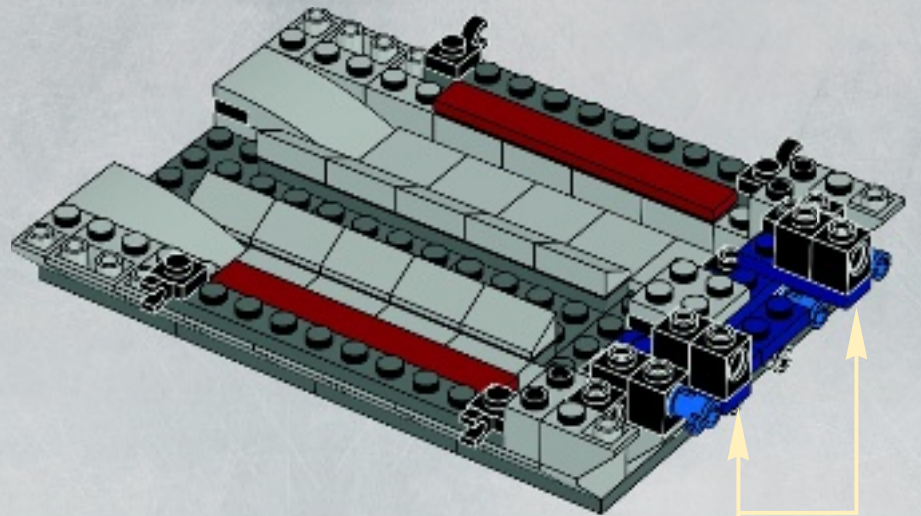
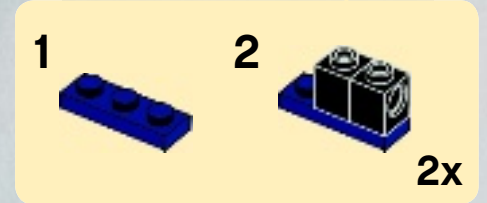



12

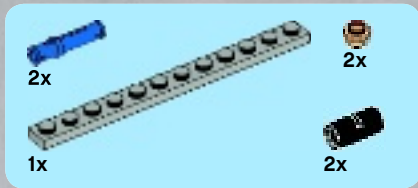
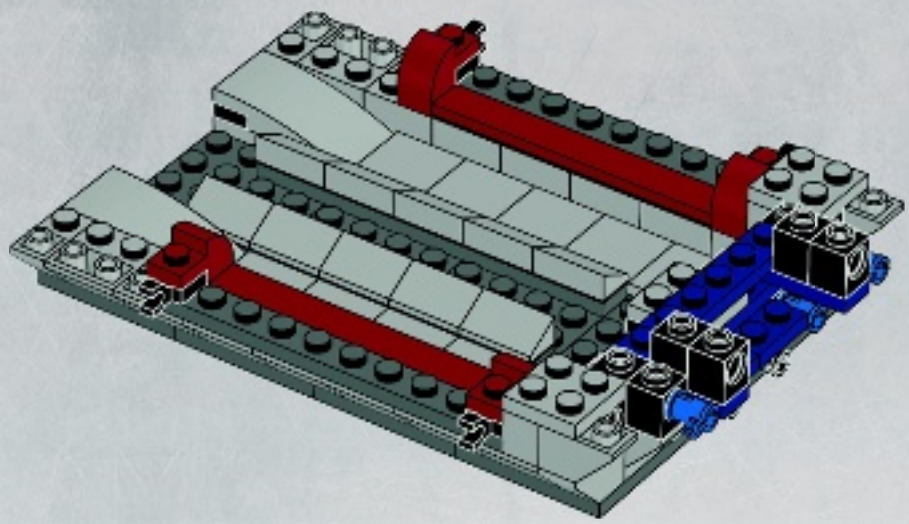

13

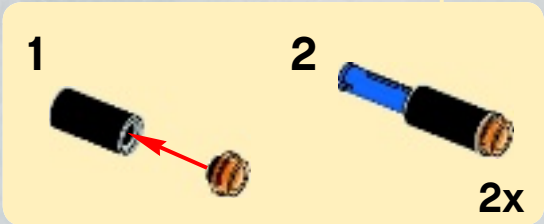
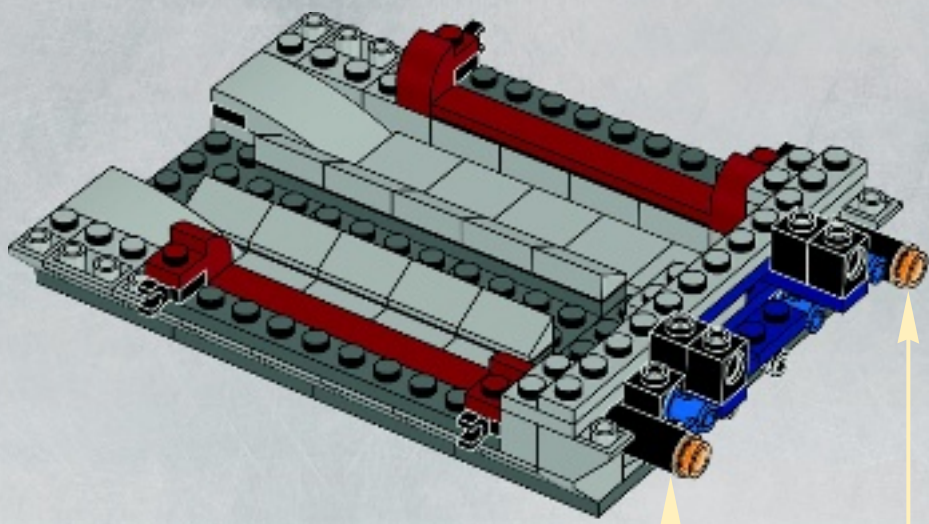

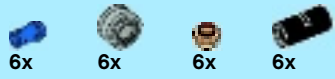

# 14

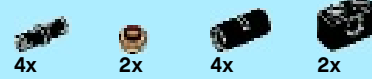
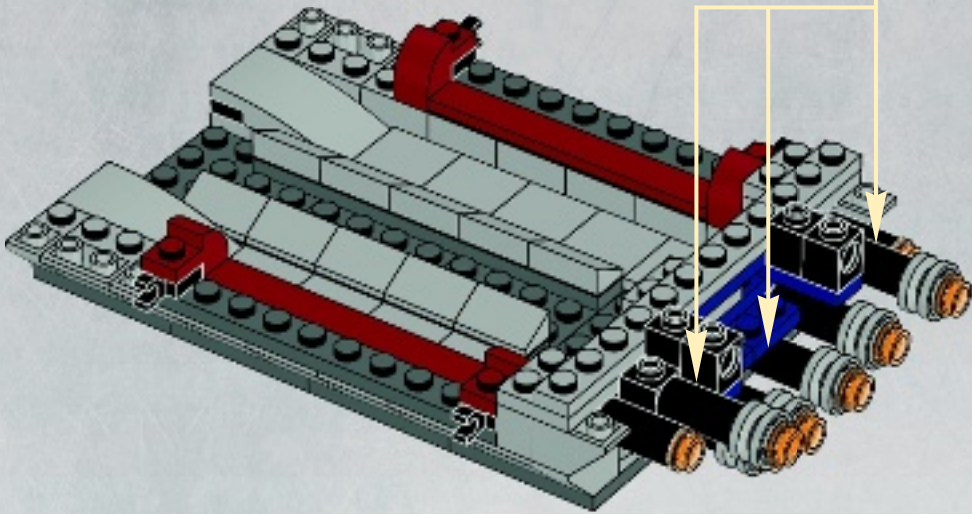
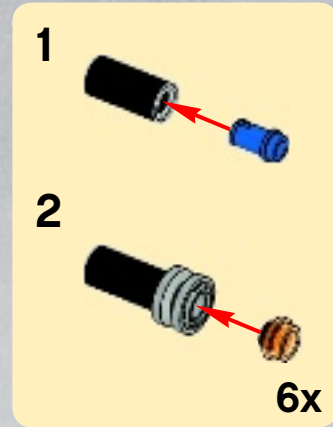

# 15

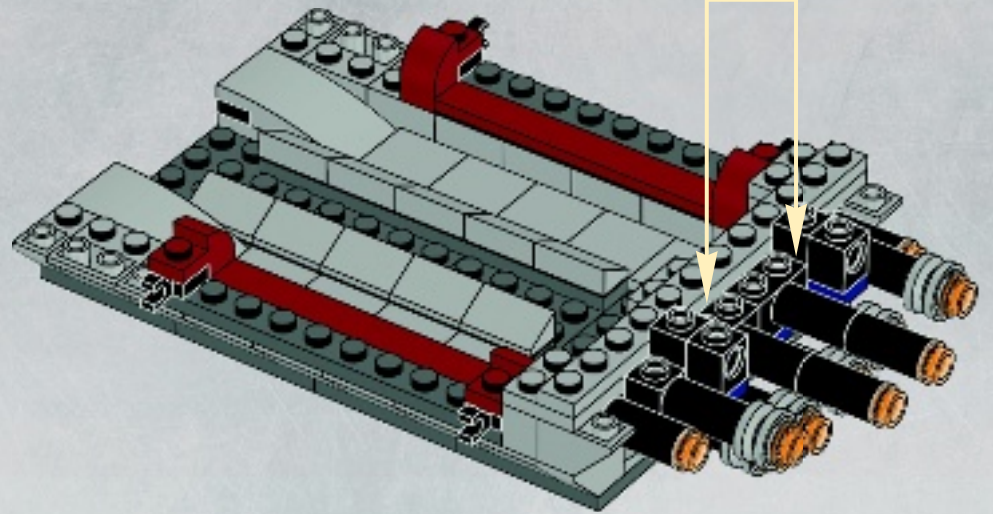
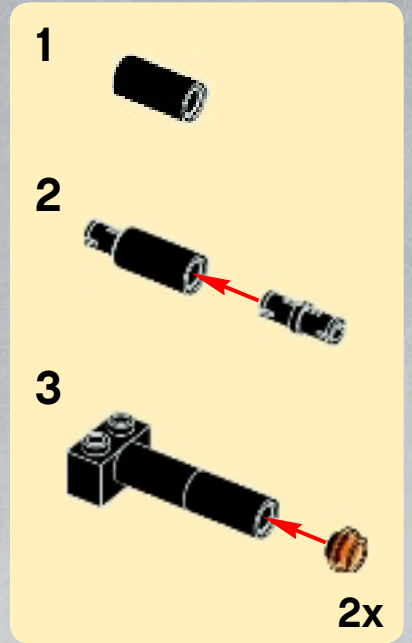



16

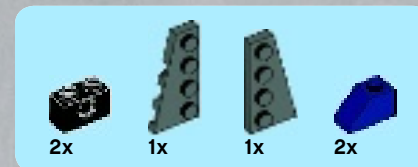
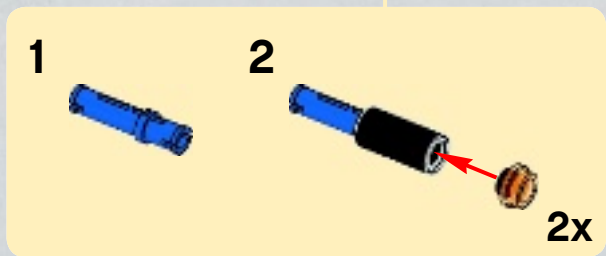
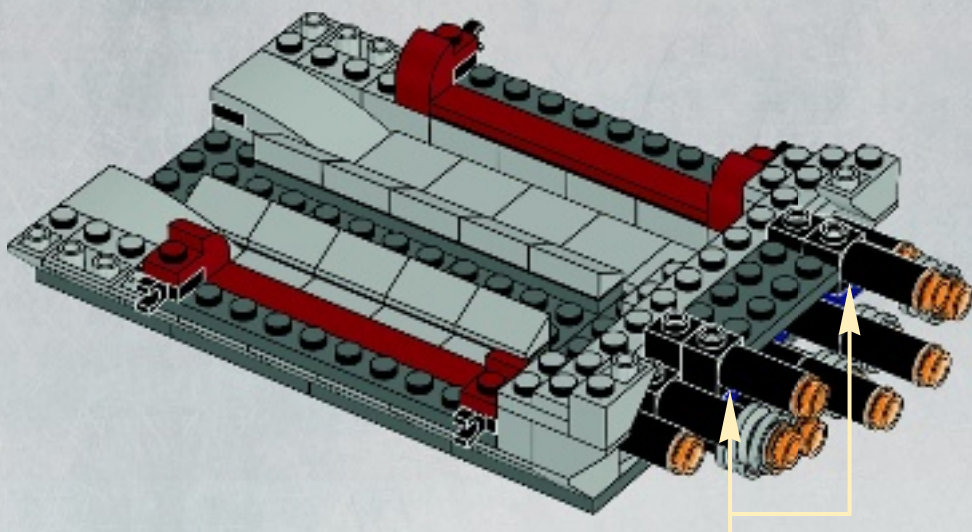

17

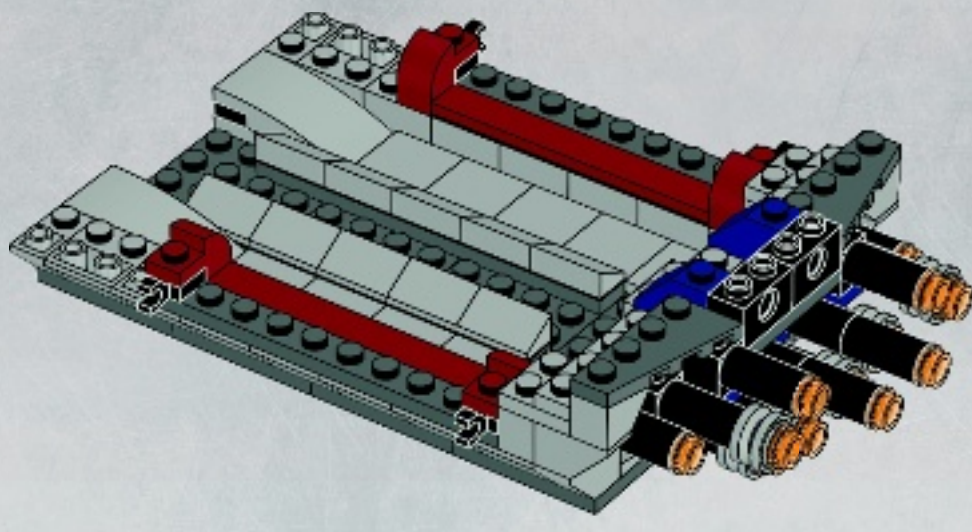



# 18

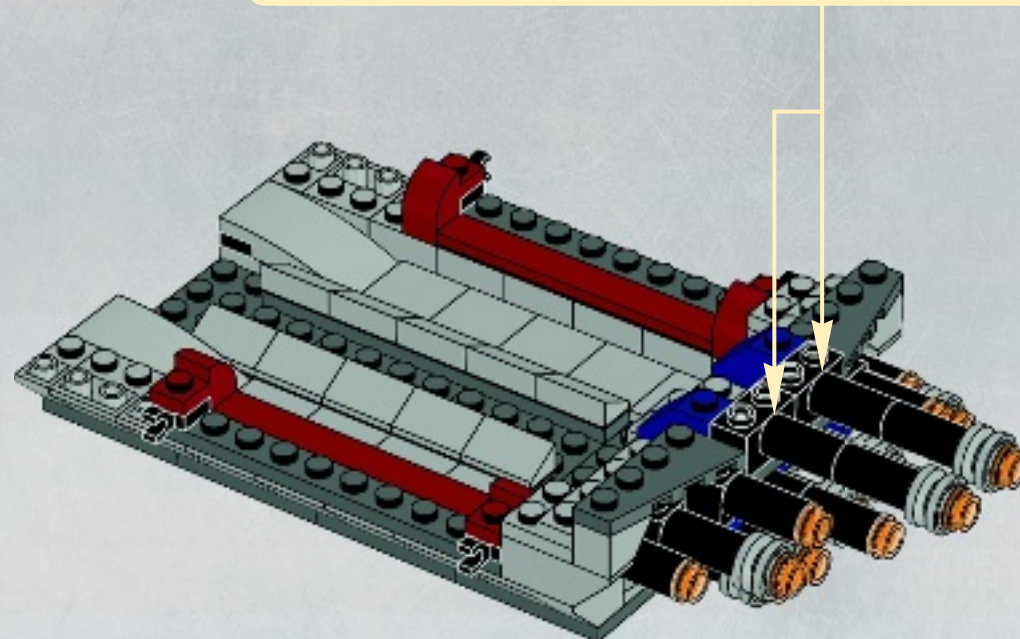
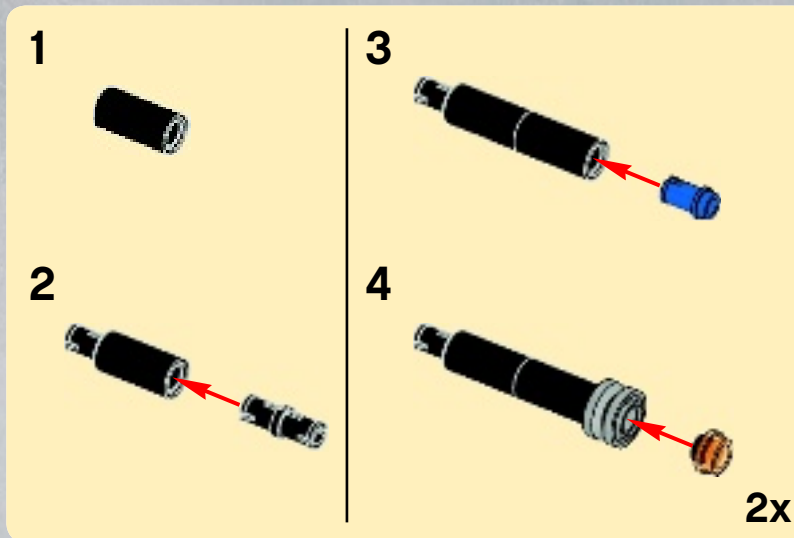



4x



2x



2x



2x



4x

# 19

1



2



3

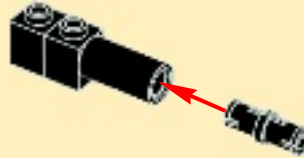

4

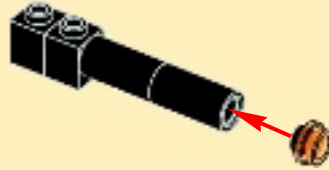

2x

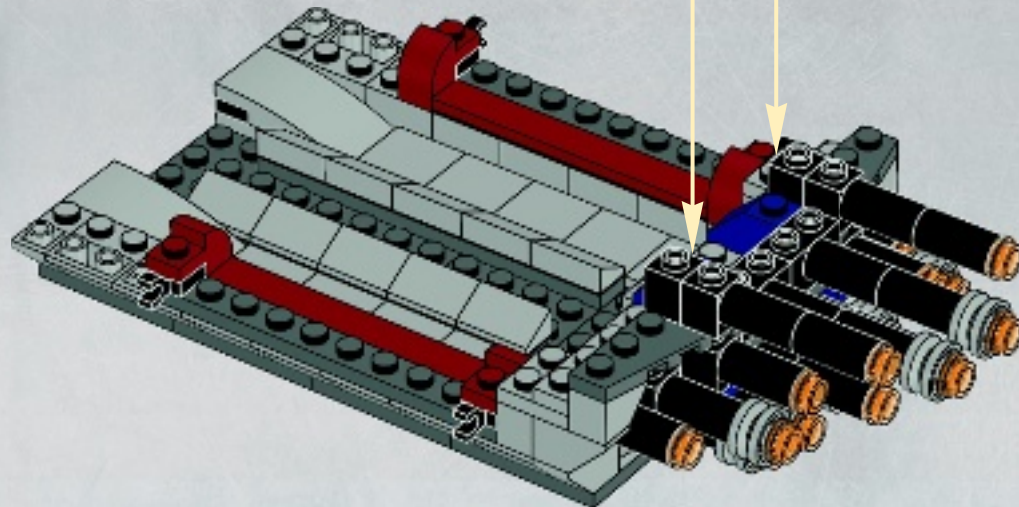



2x



2x

# 20

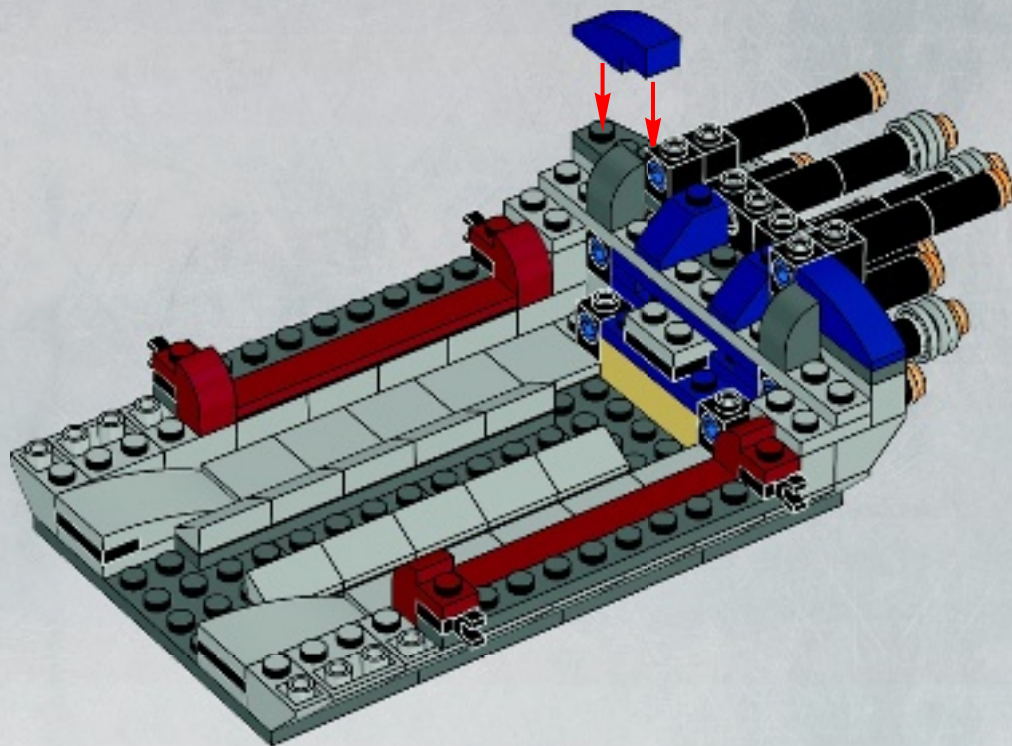



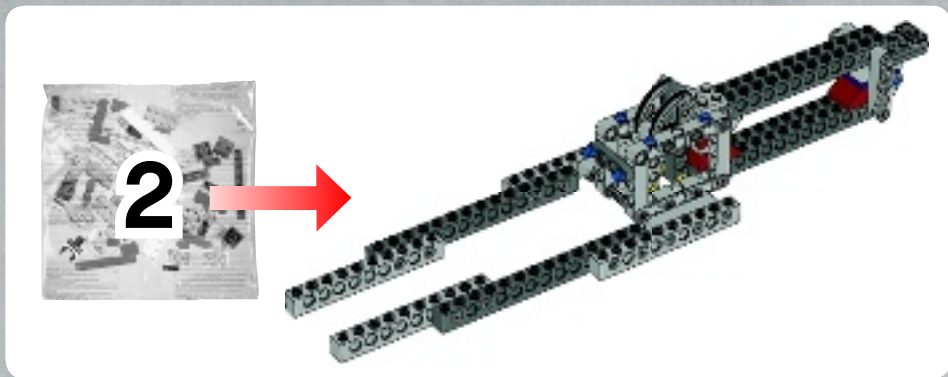

1

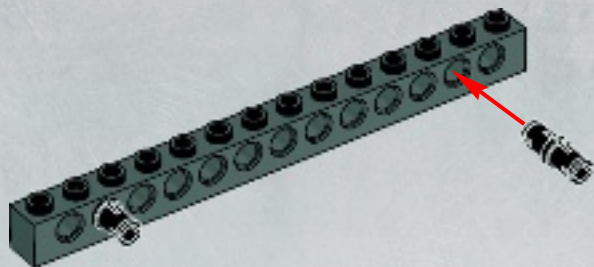

2

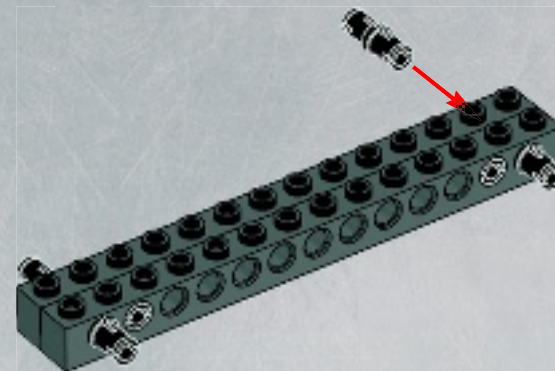

3

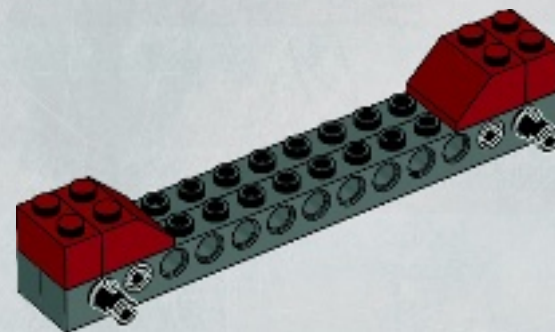



1x



1x

# 4

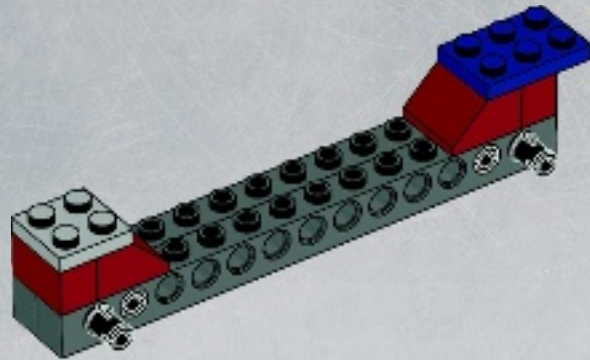

1x



2x



1x

# 5

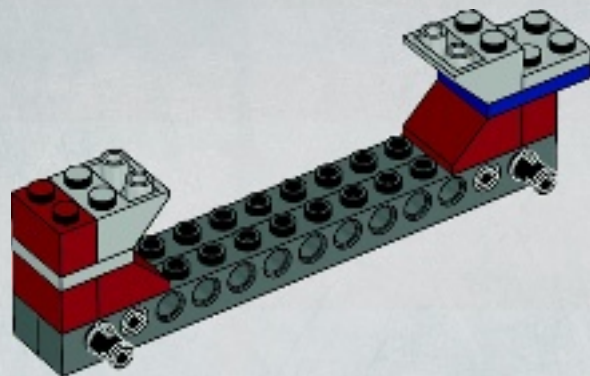

1x



2x

# 6

## 1

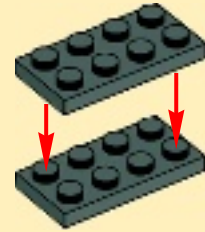

## 2

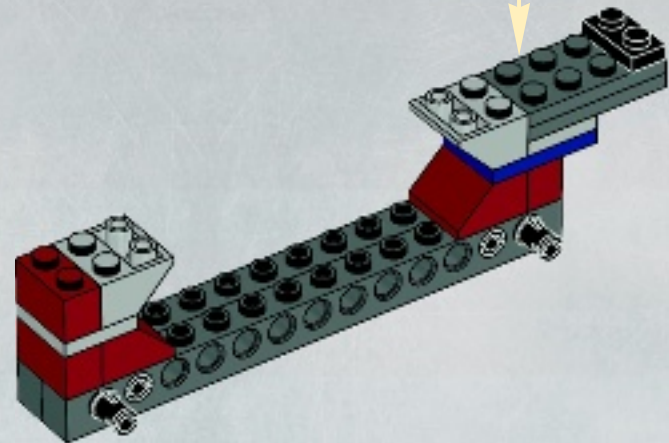



7

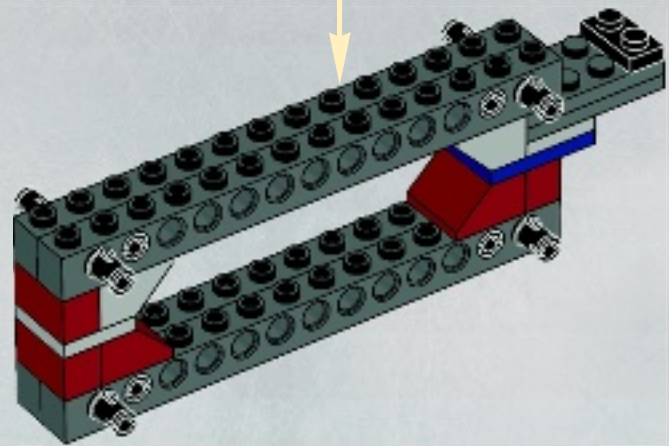
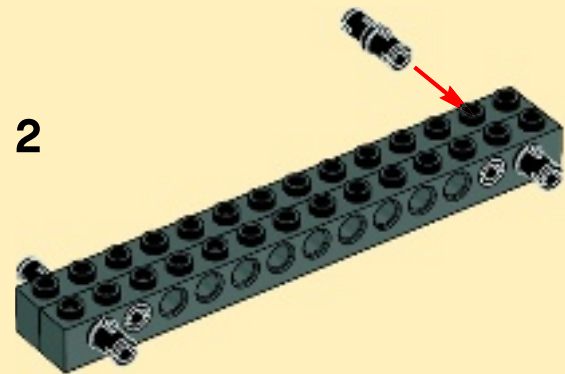
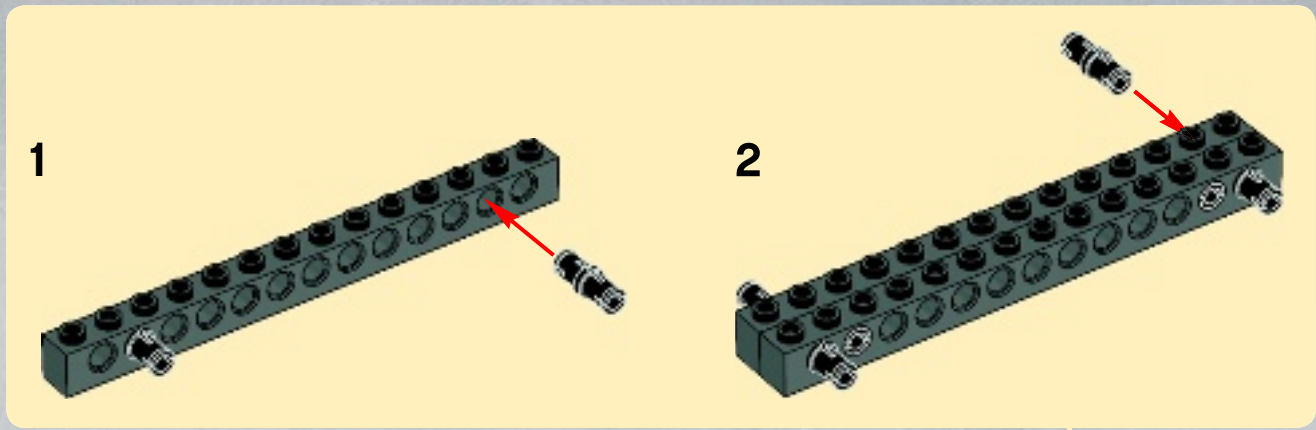

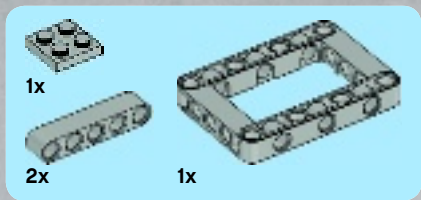

8

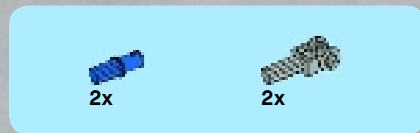
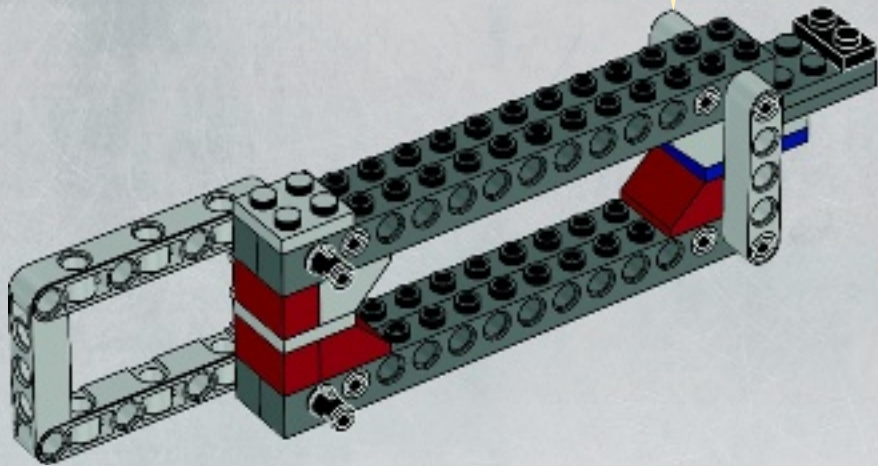
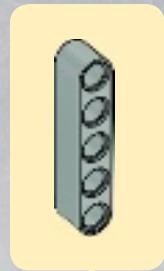

9

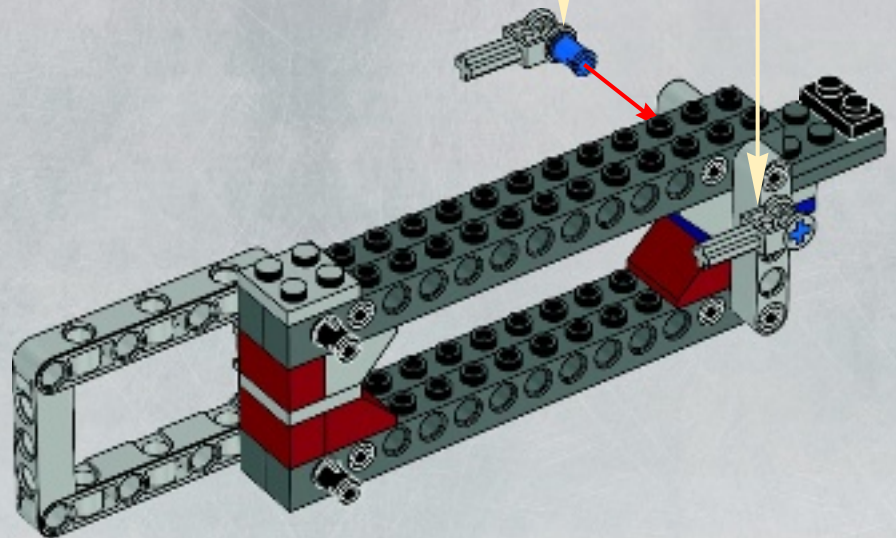
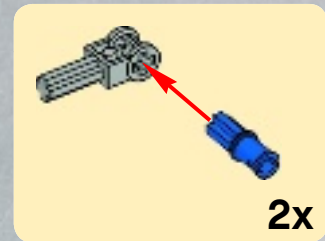

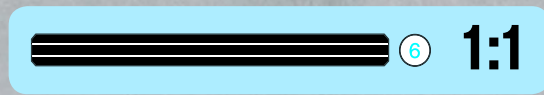
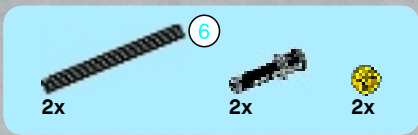

# 10

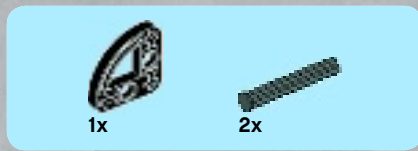
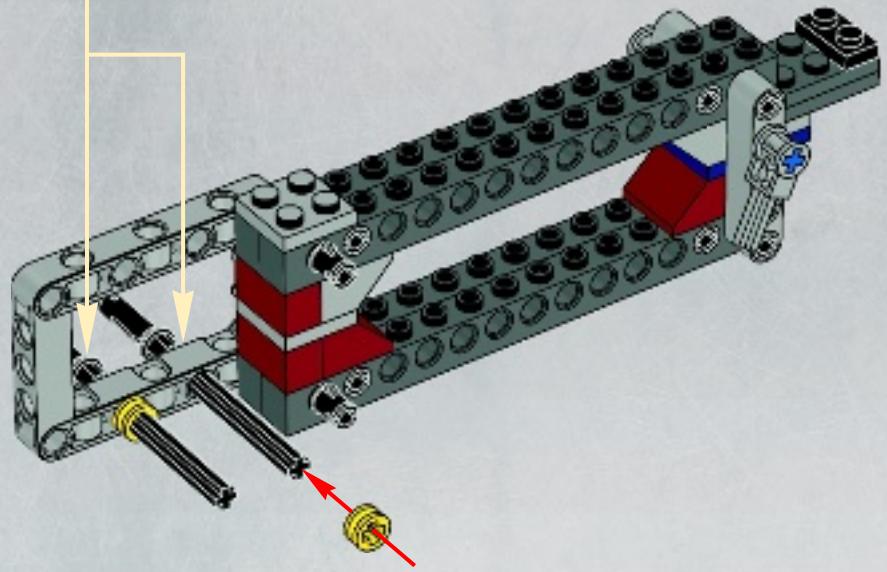
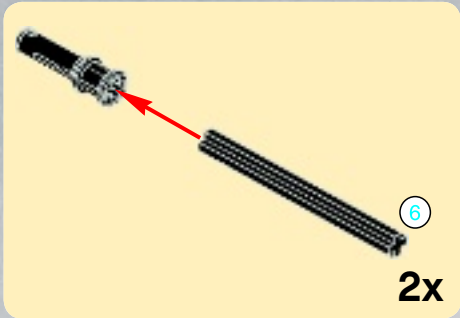

# 11

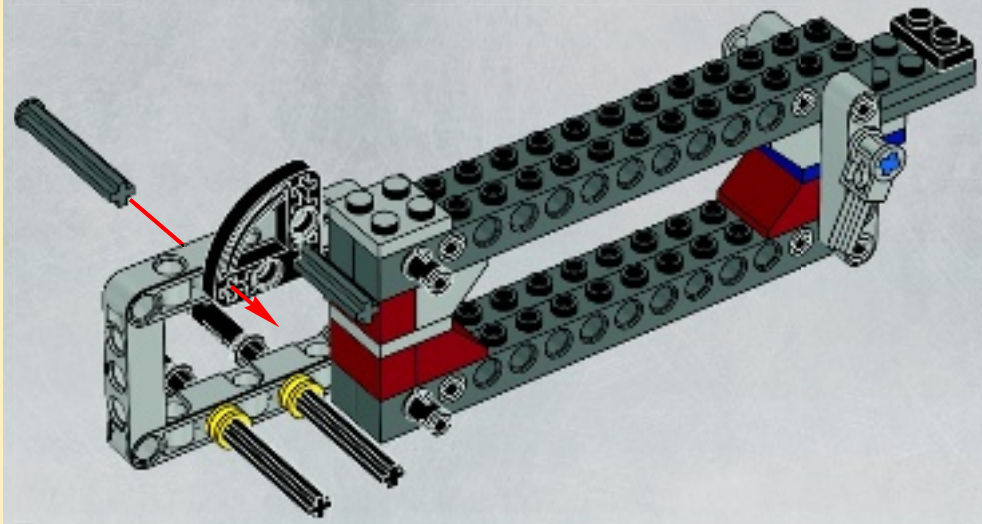



12

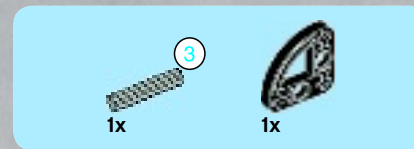
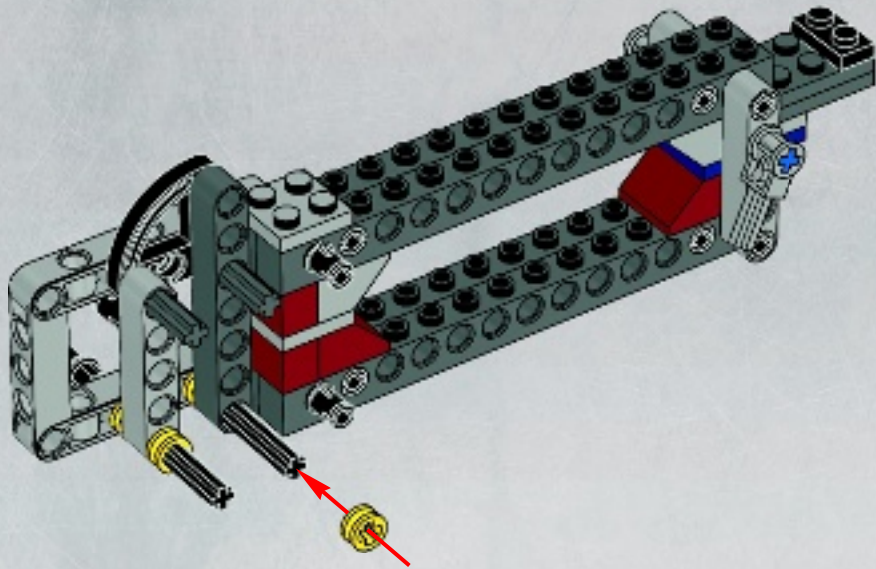

13

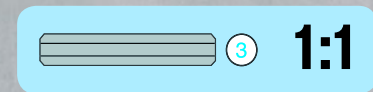
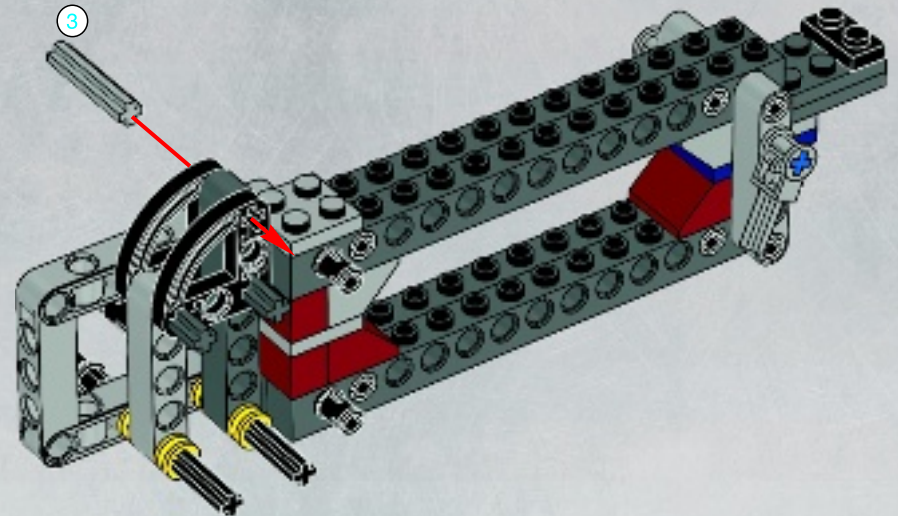

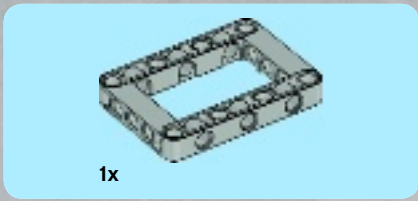

14

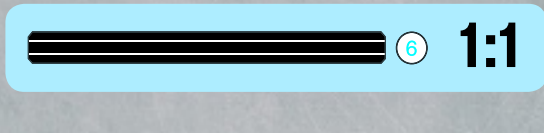
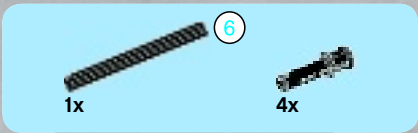
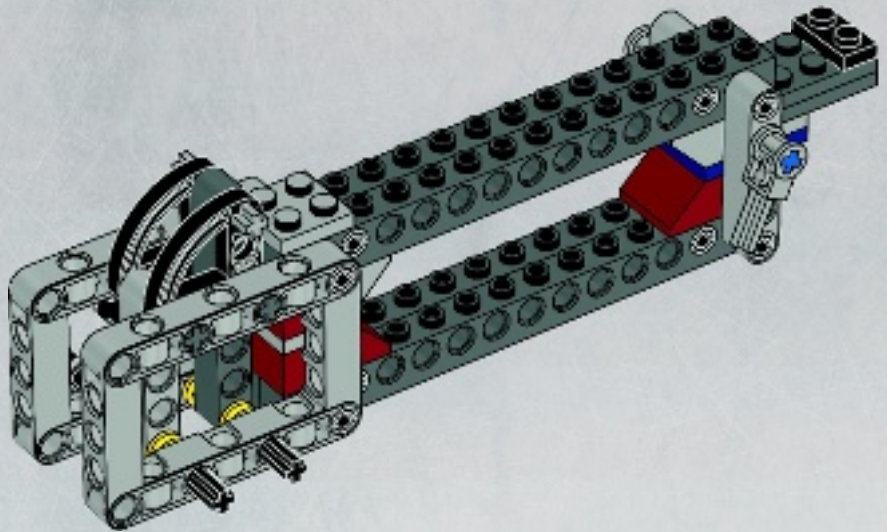

15

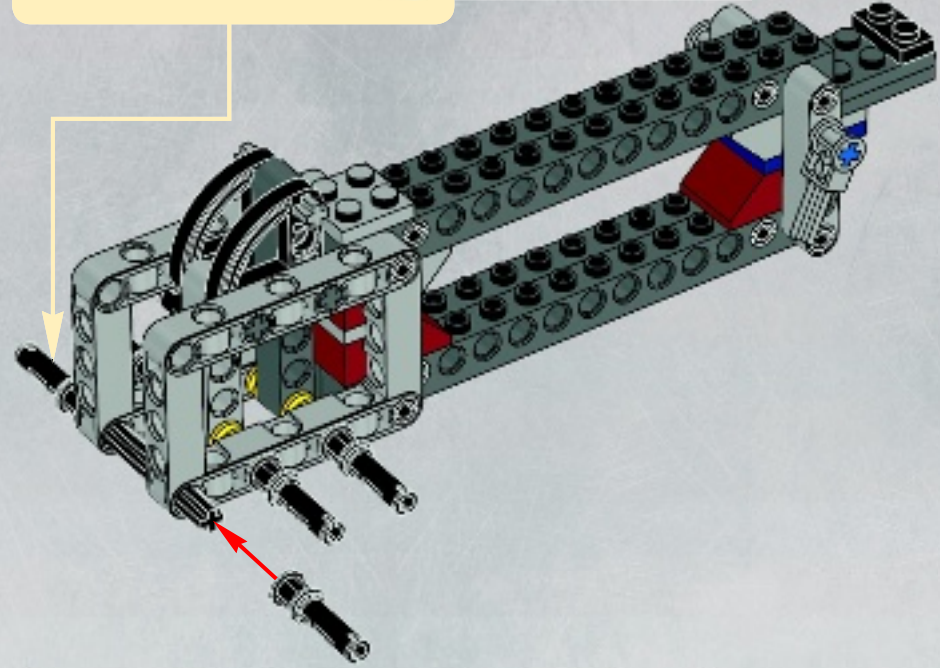
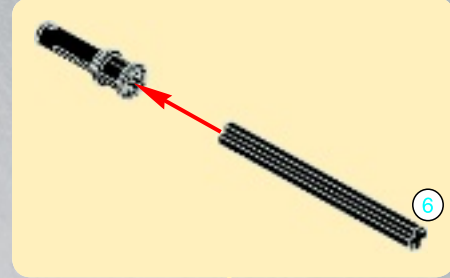



16

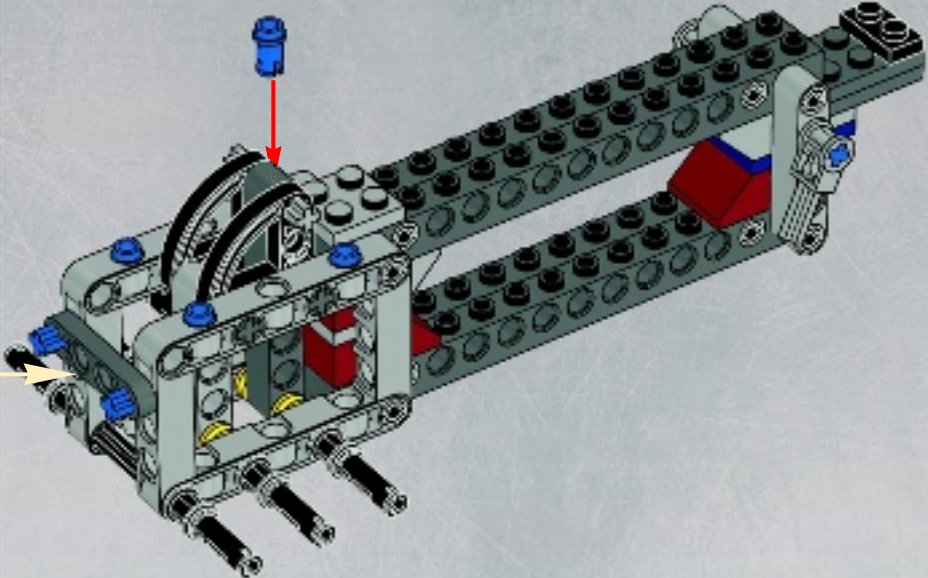
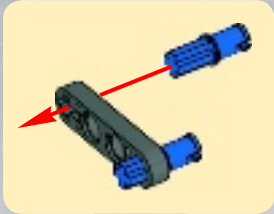

17

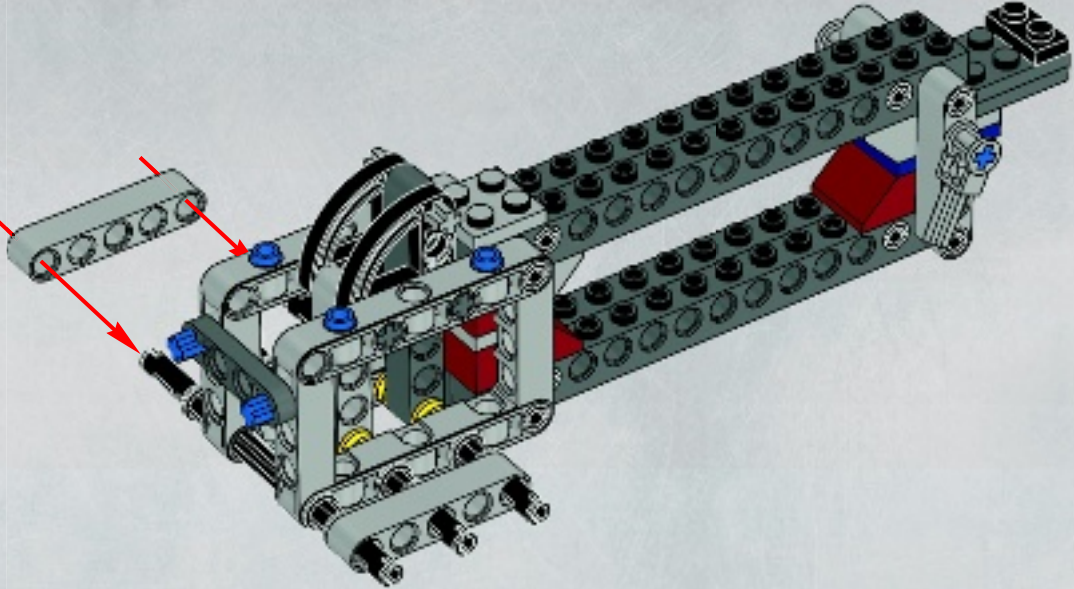



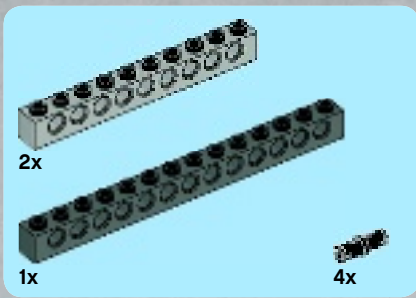

18

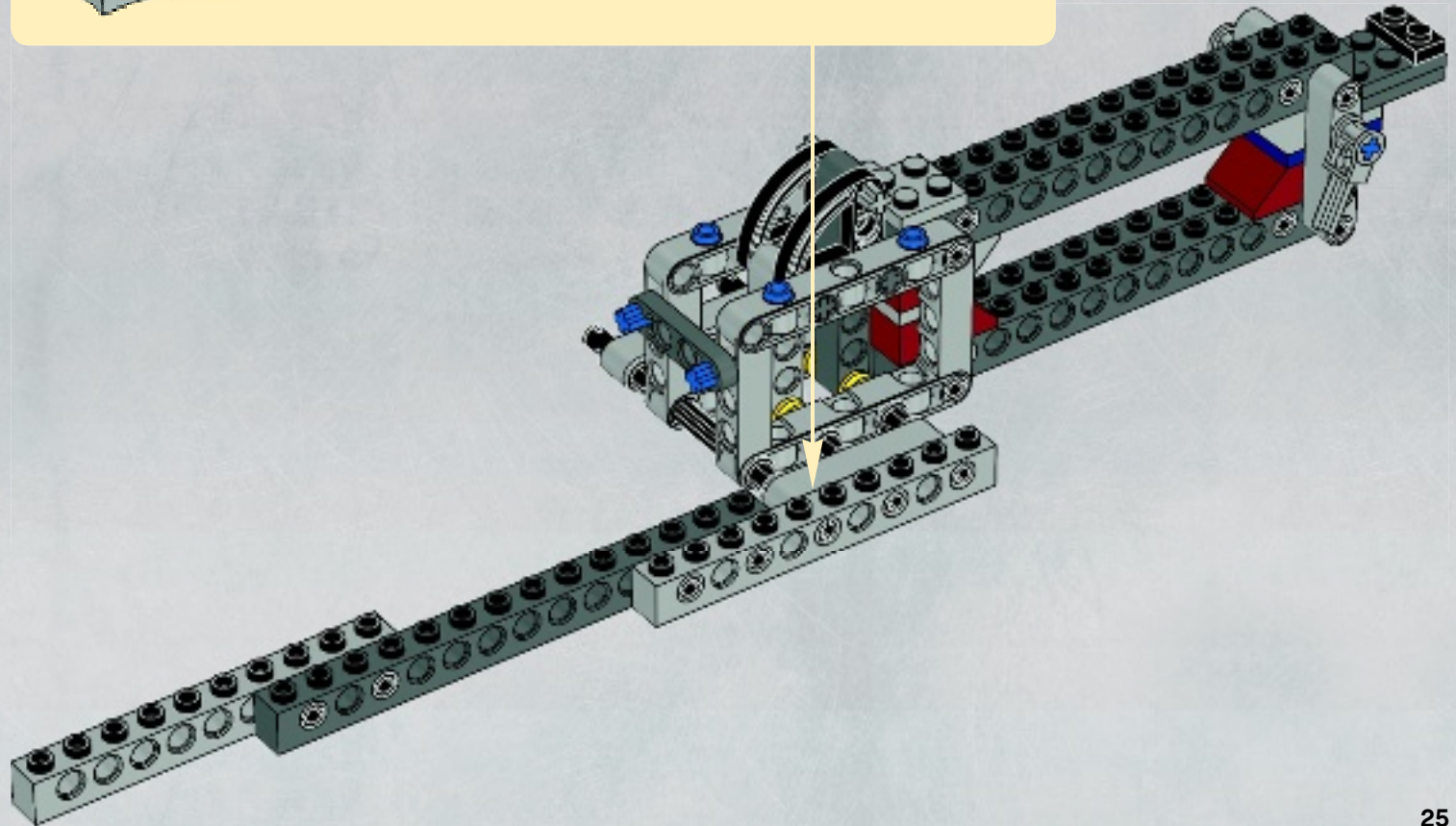
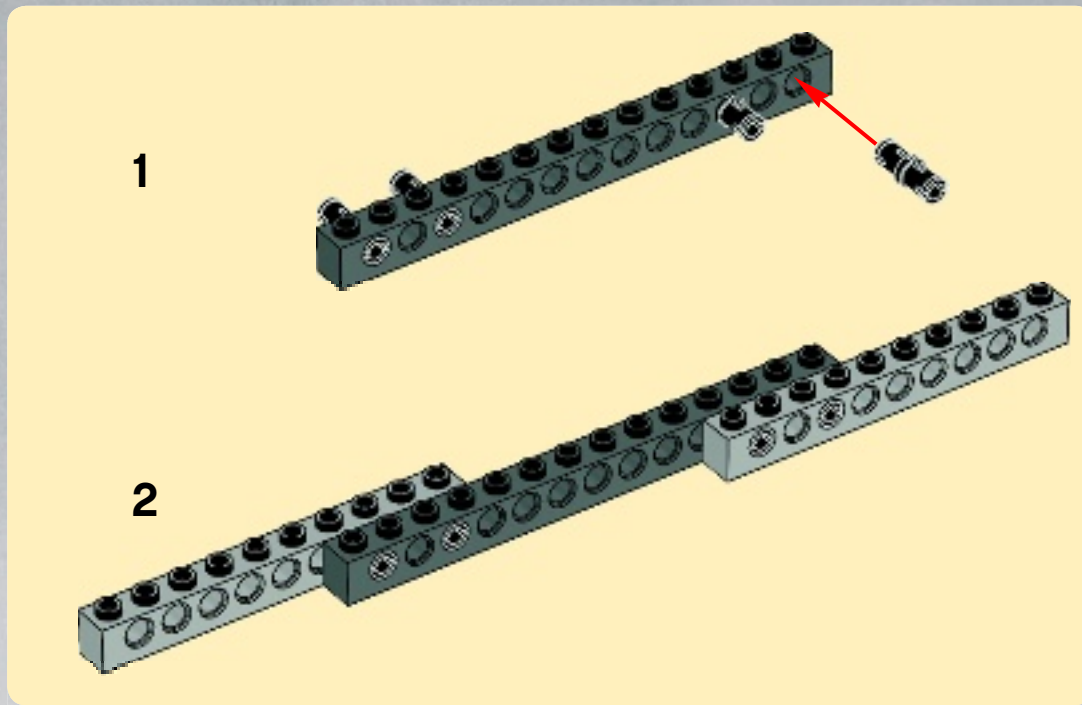

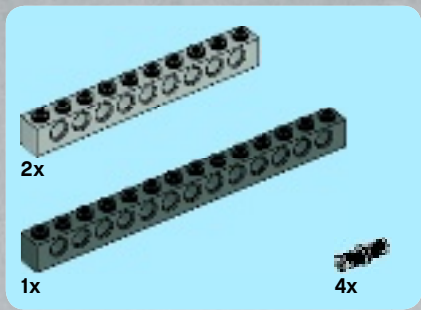

19

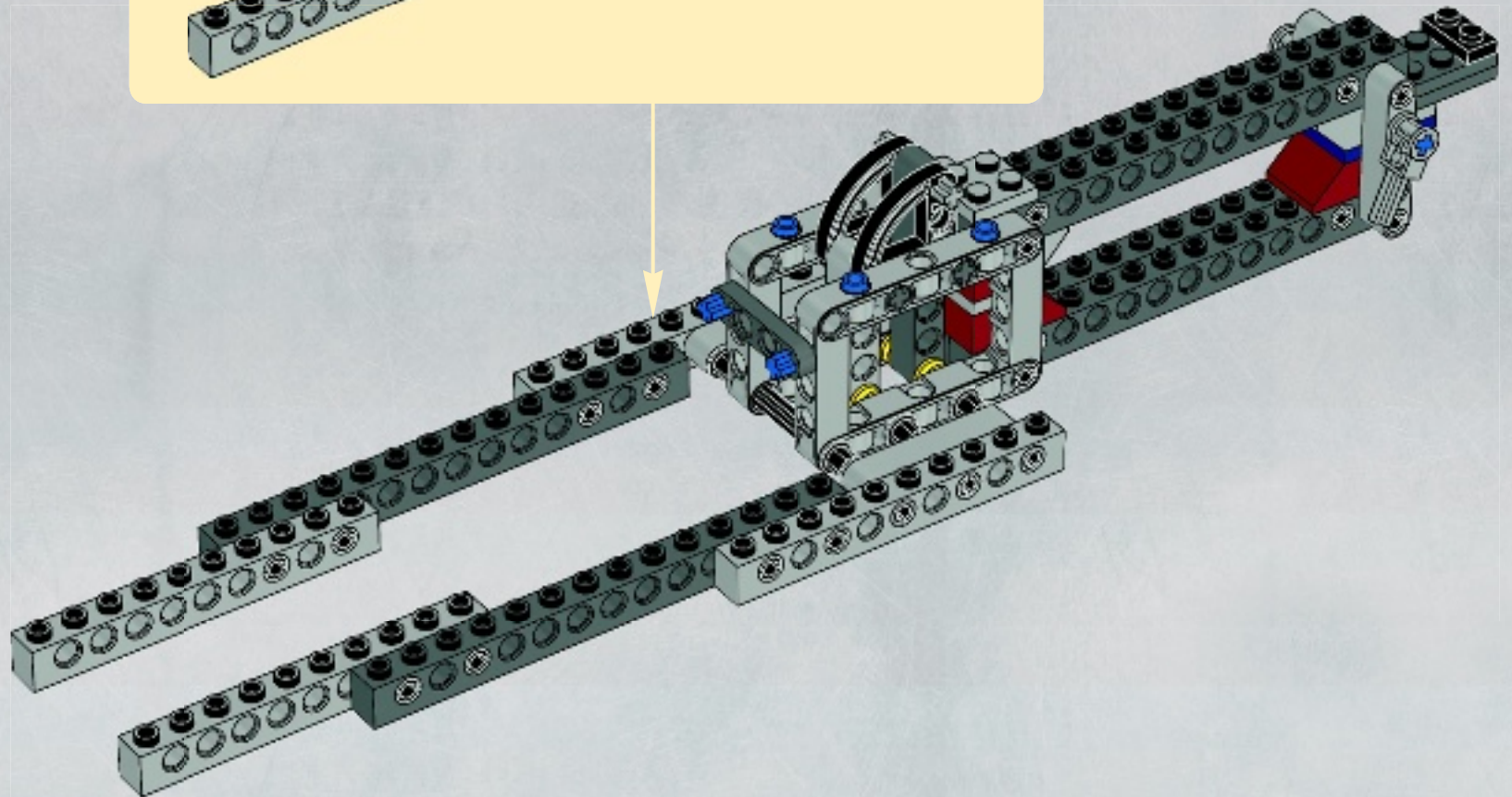
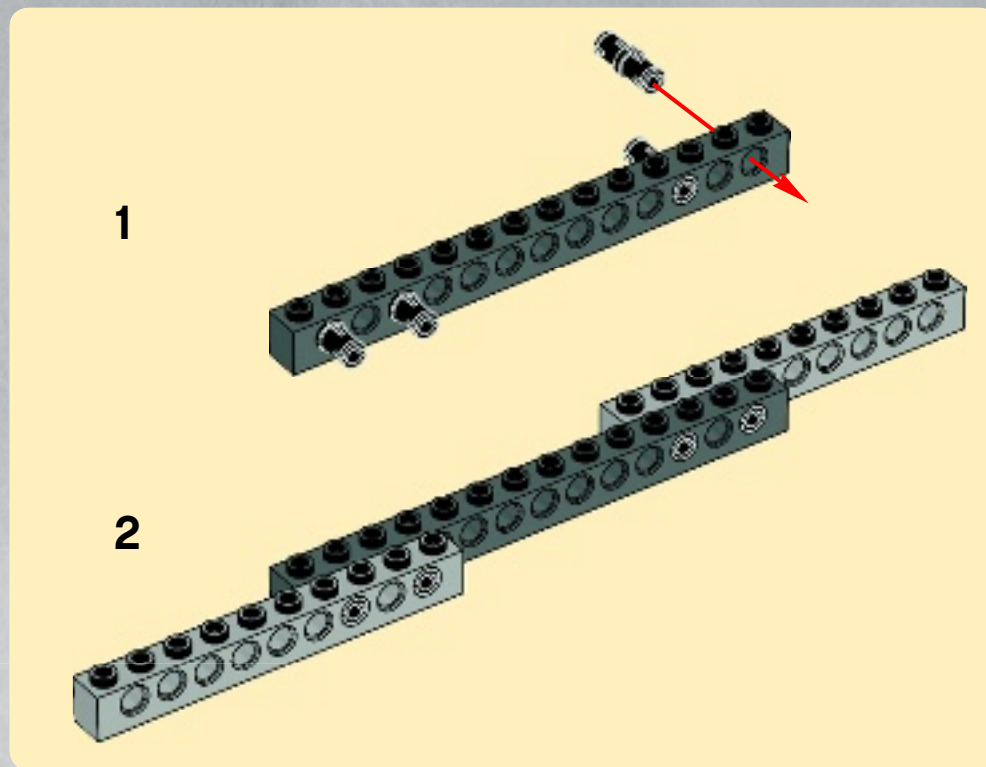

20

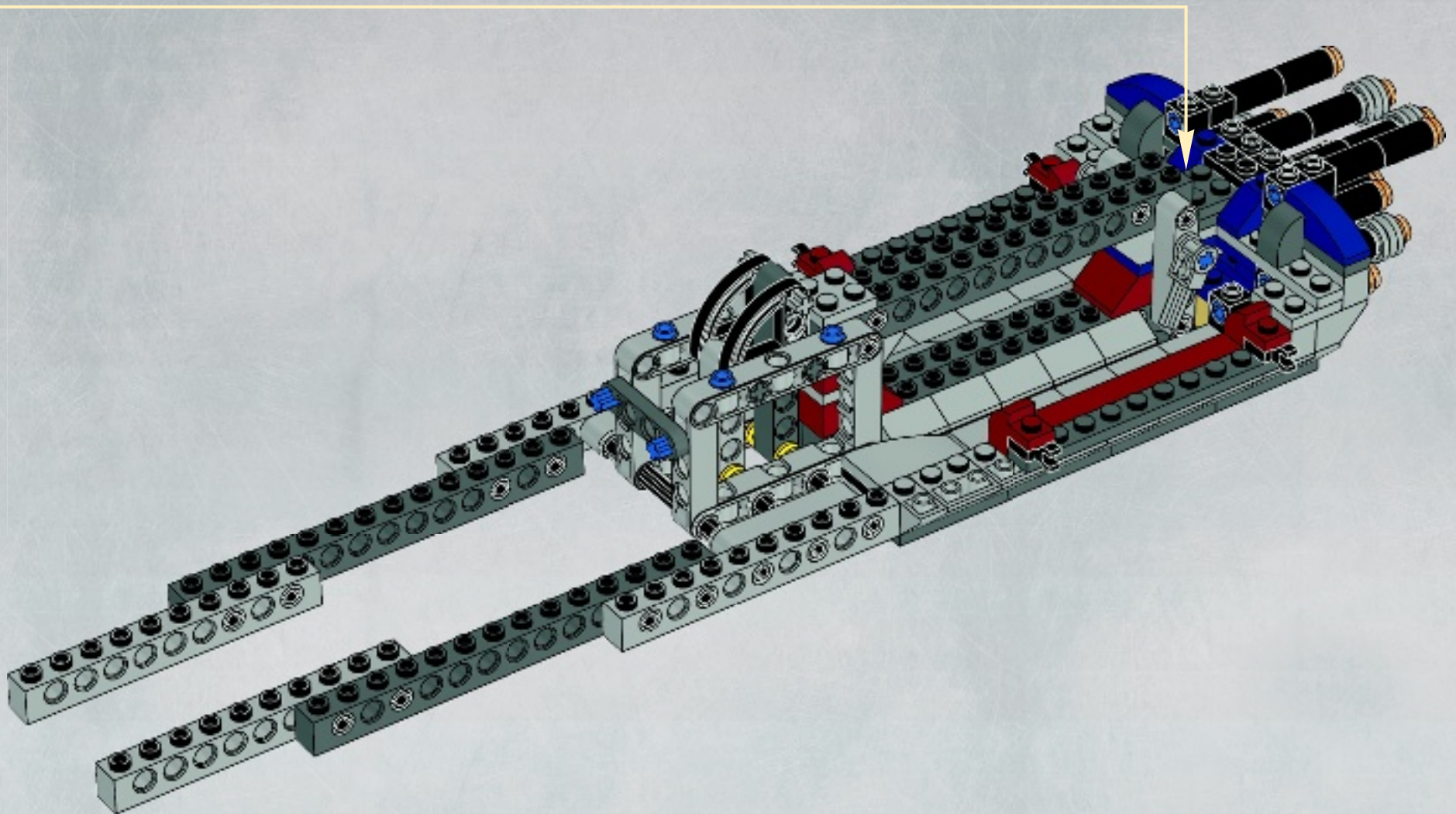

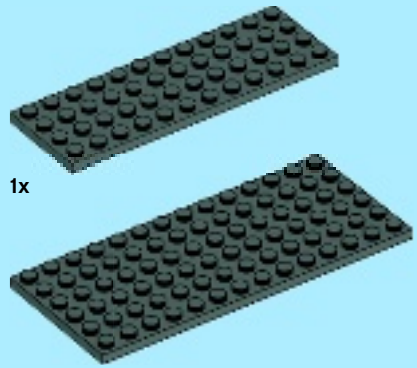
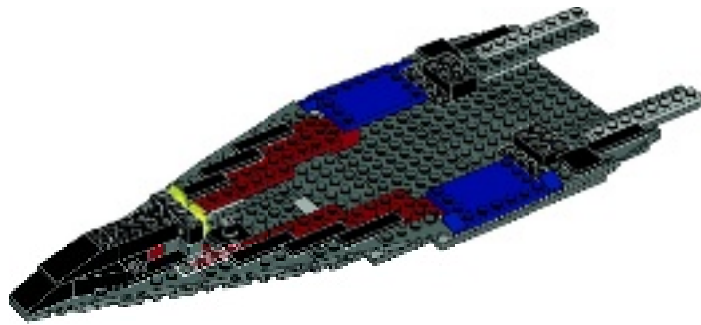

21

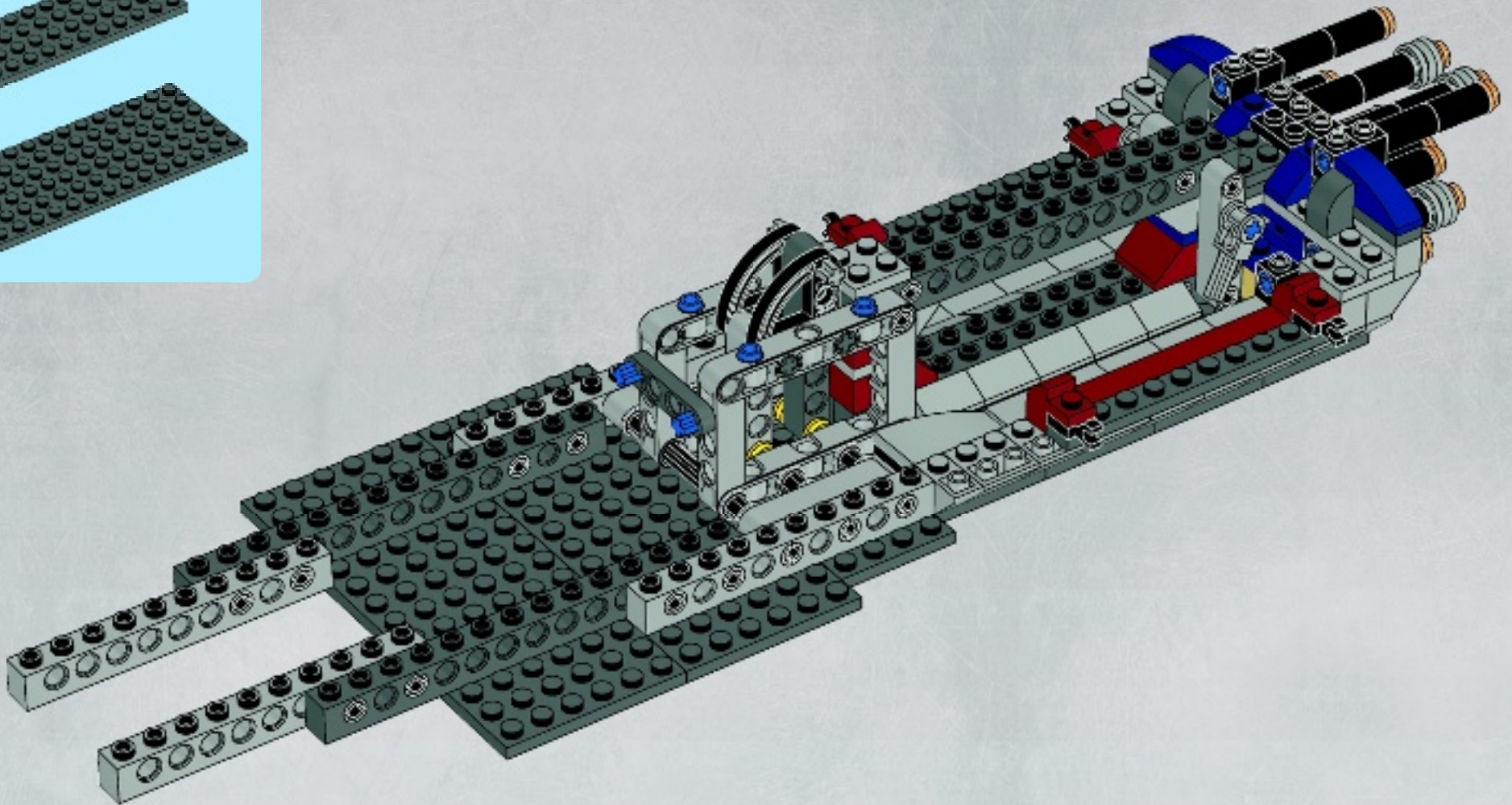



16x



2x

# 22

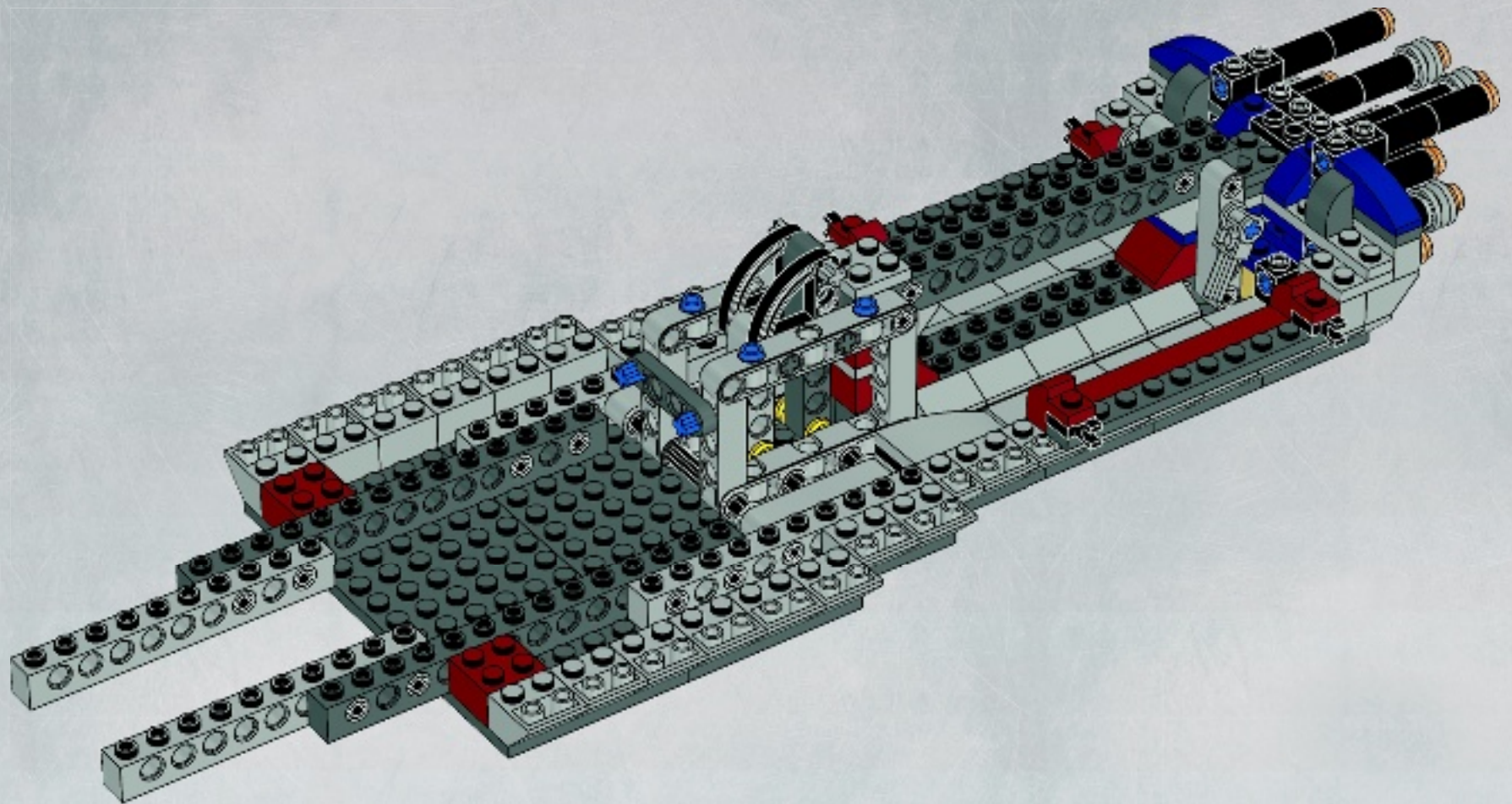

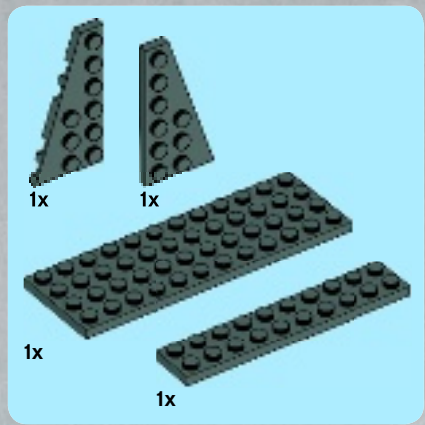

23

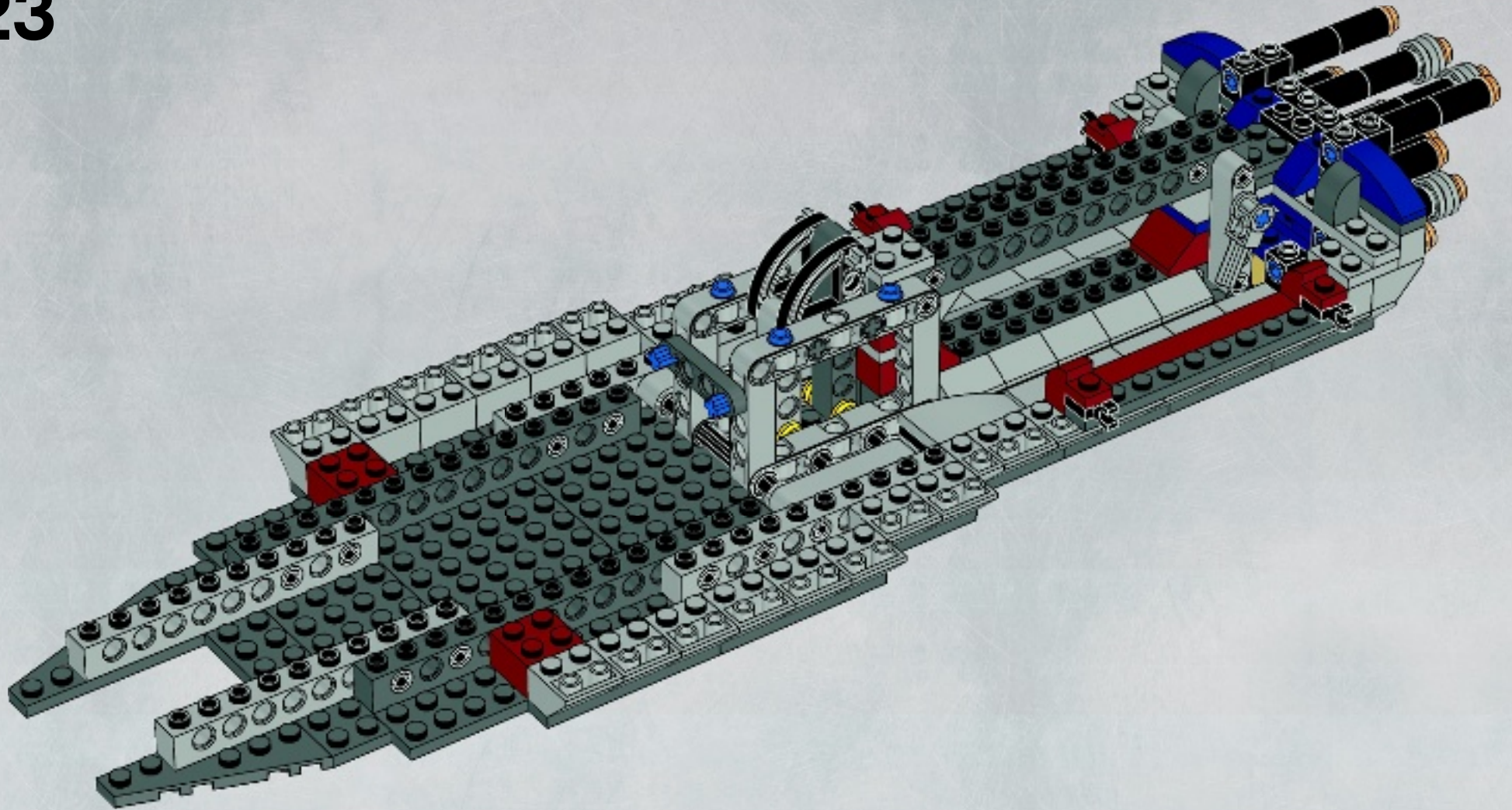

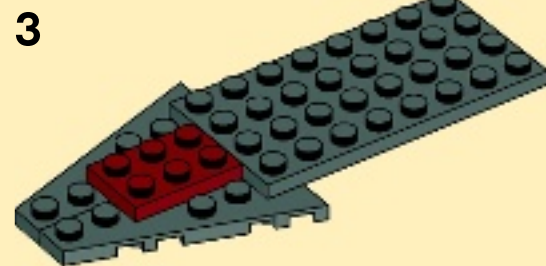
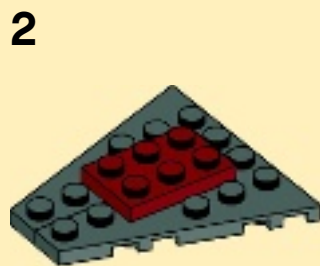
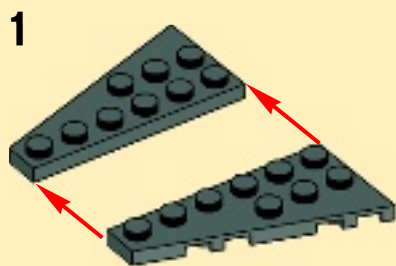
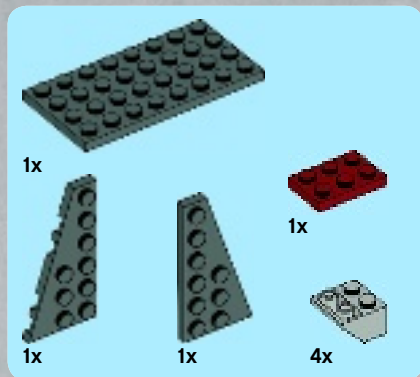

24

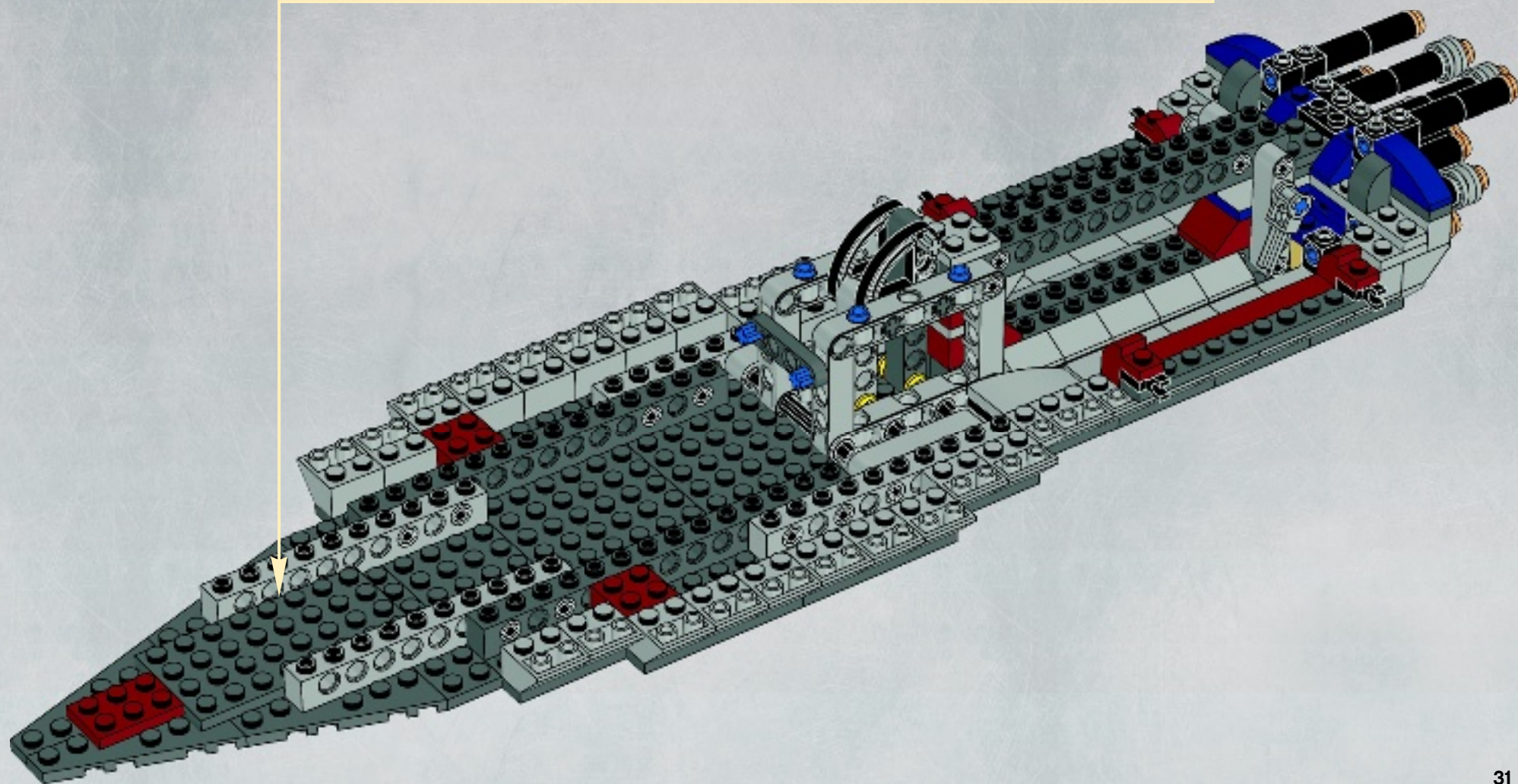



6x



8x

# 25

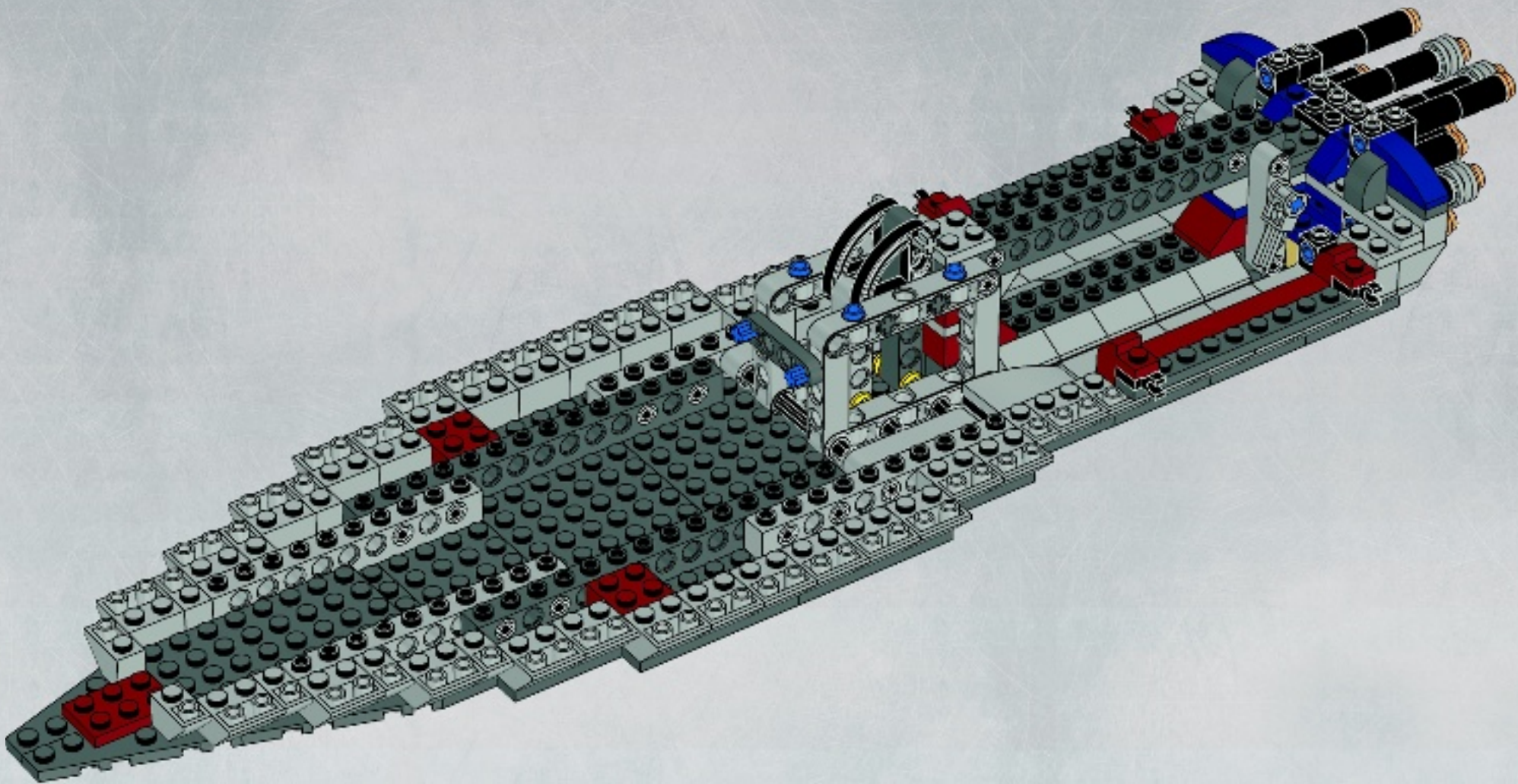



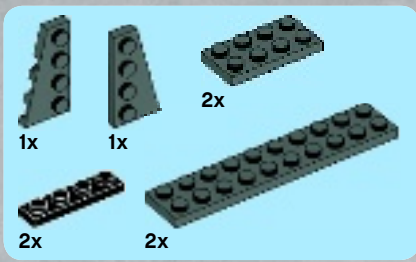

26

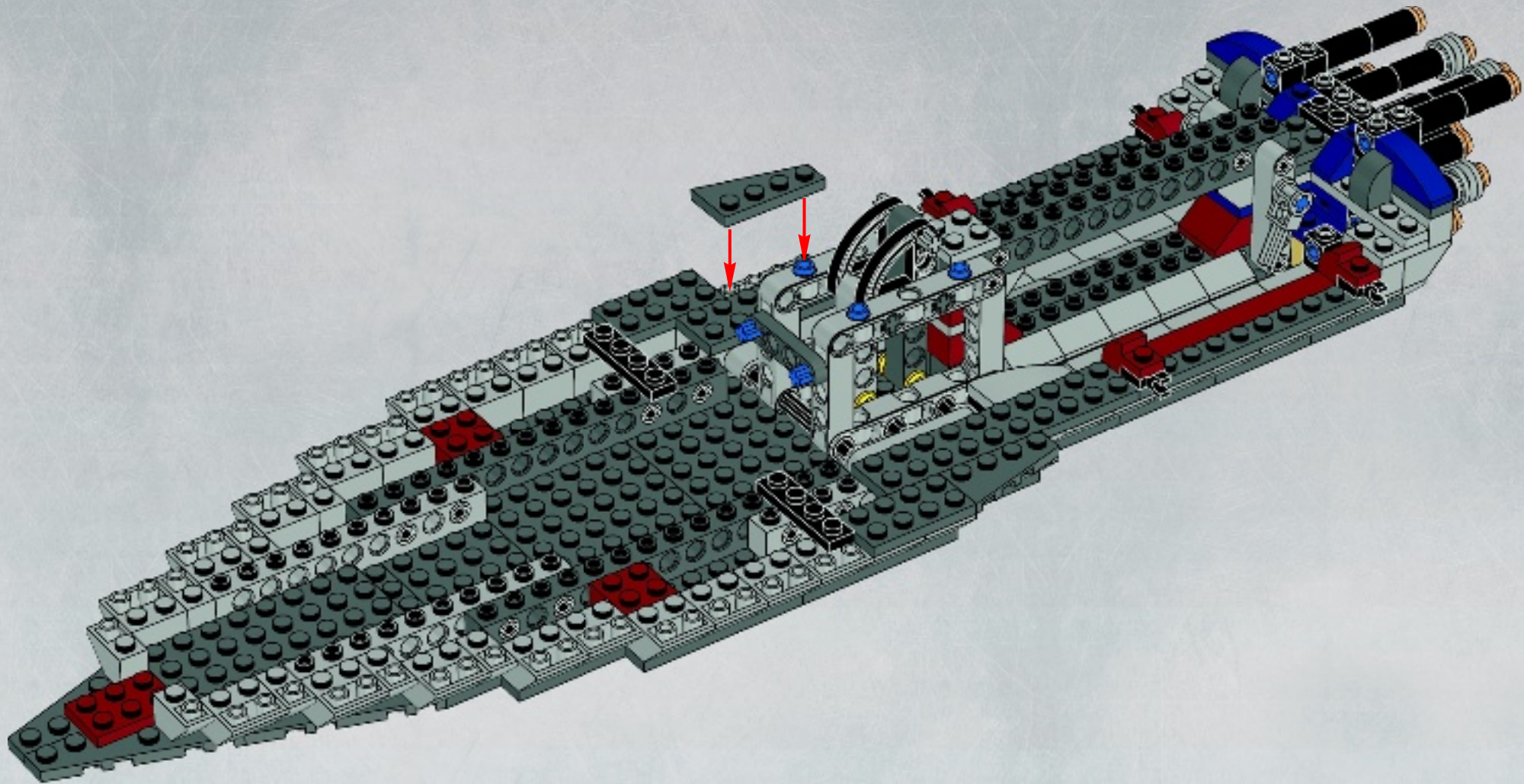

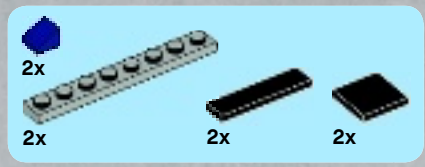

27

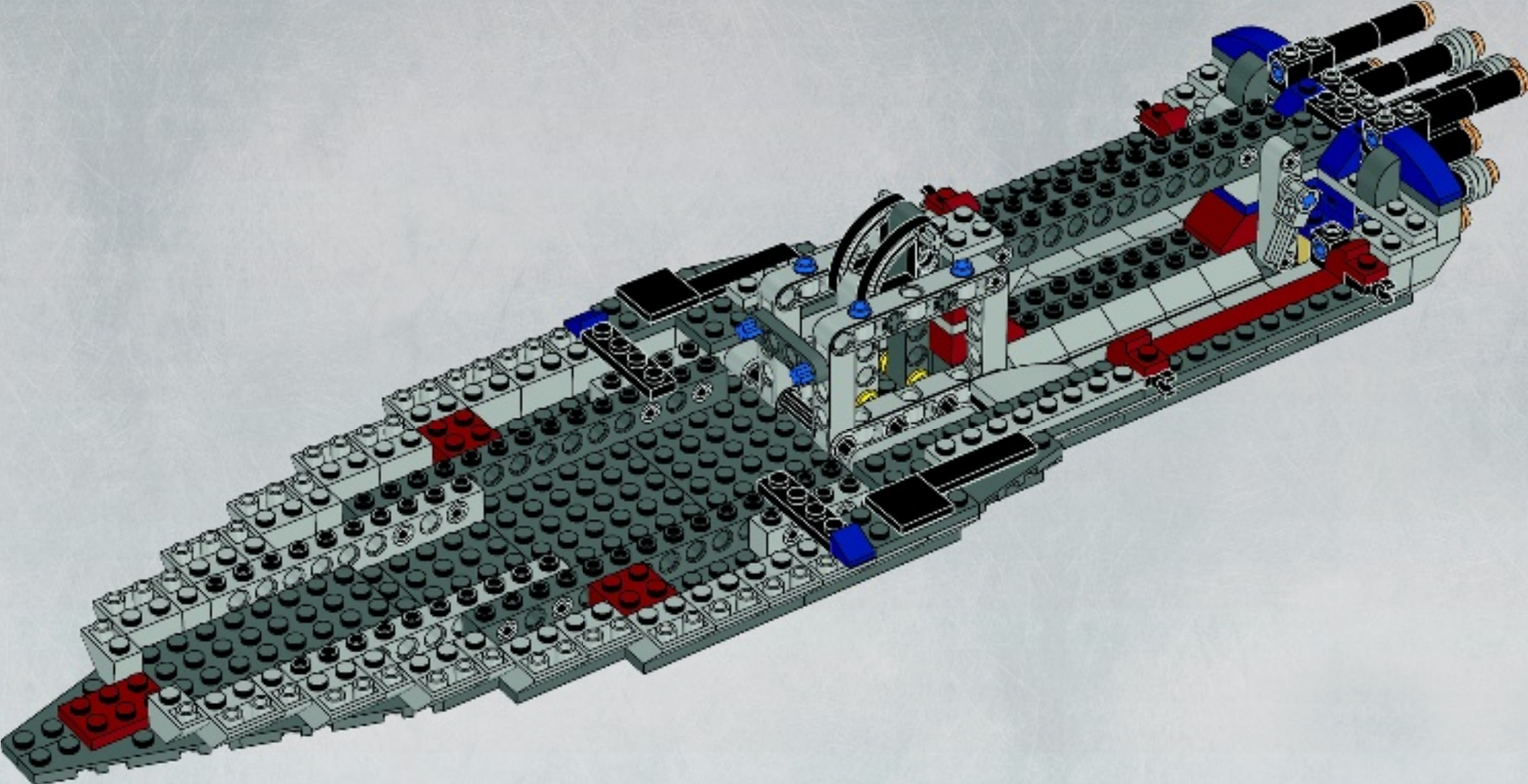

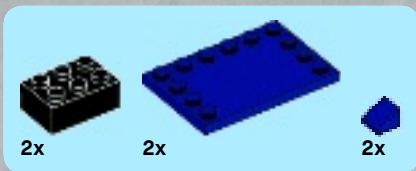

28

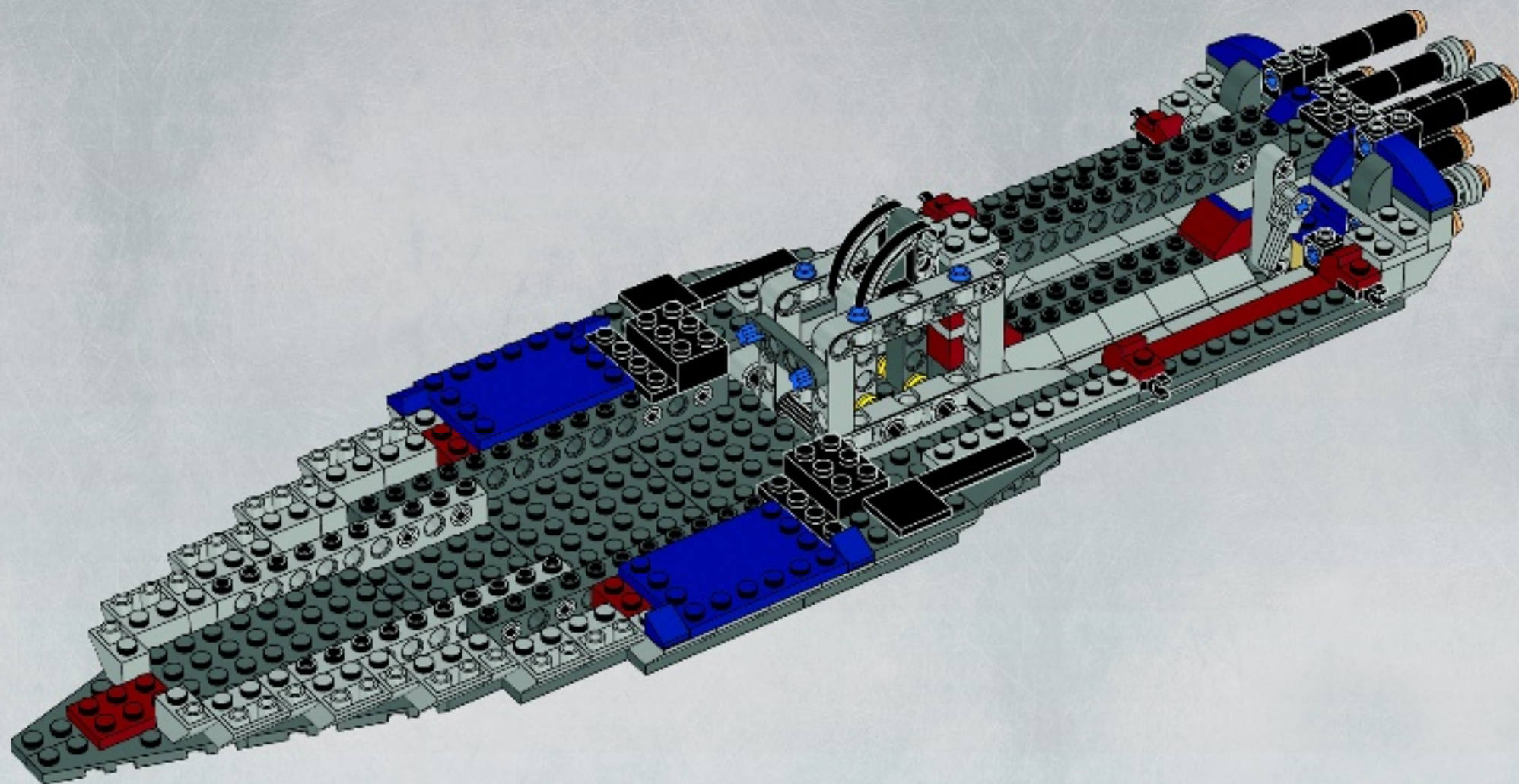



29

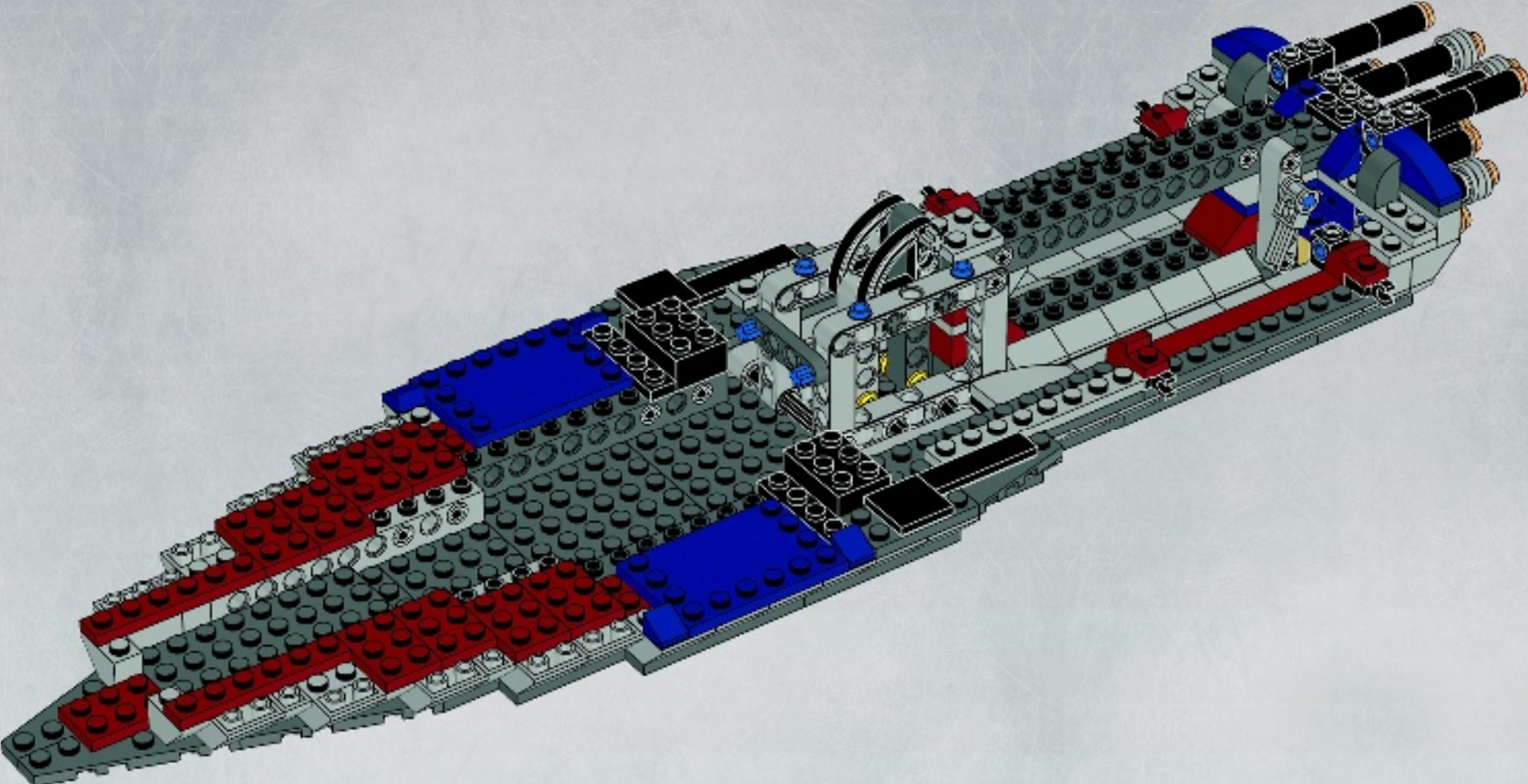

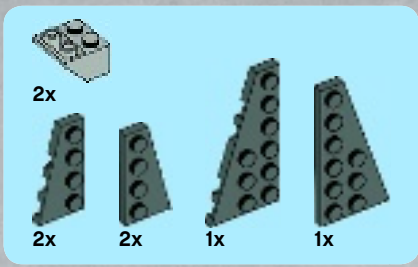

30

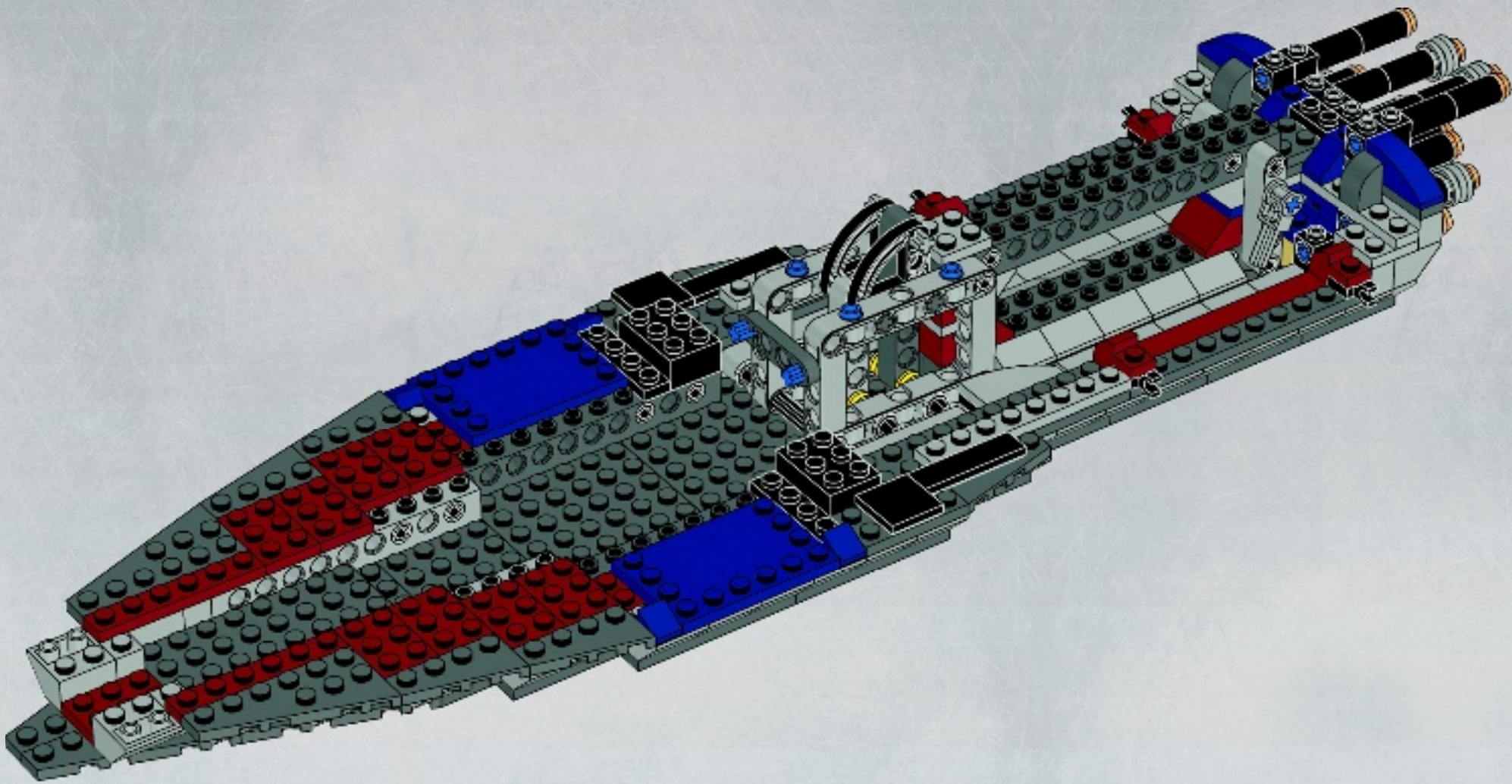

1x



1x



2x

# 31

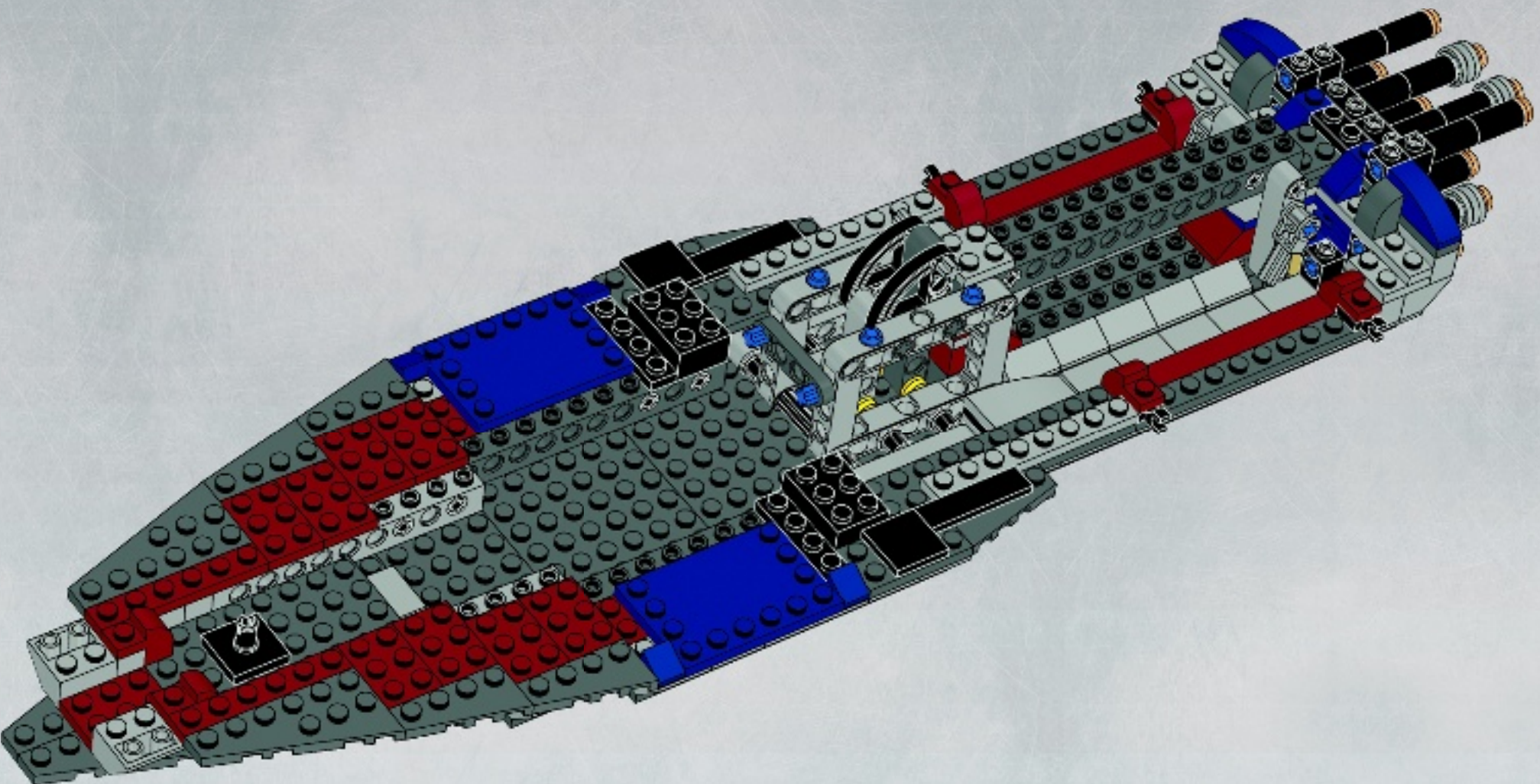



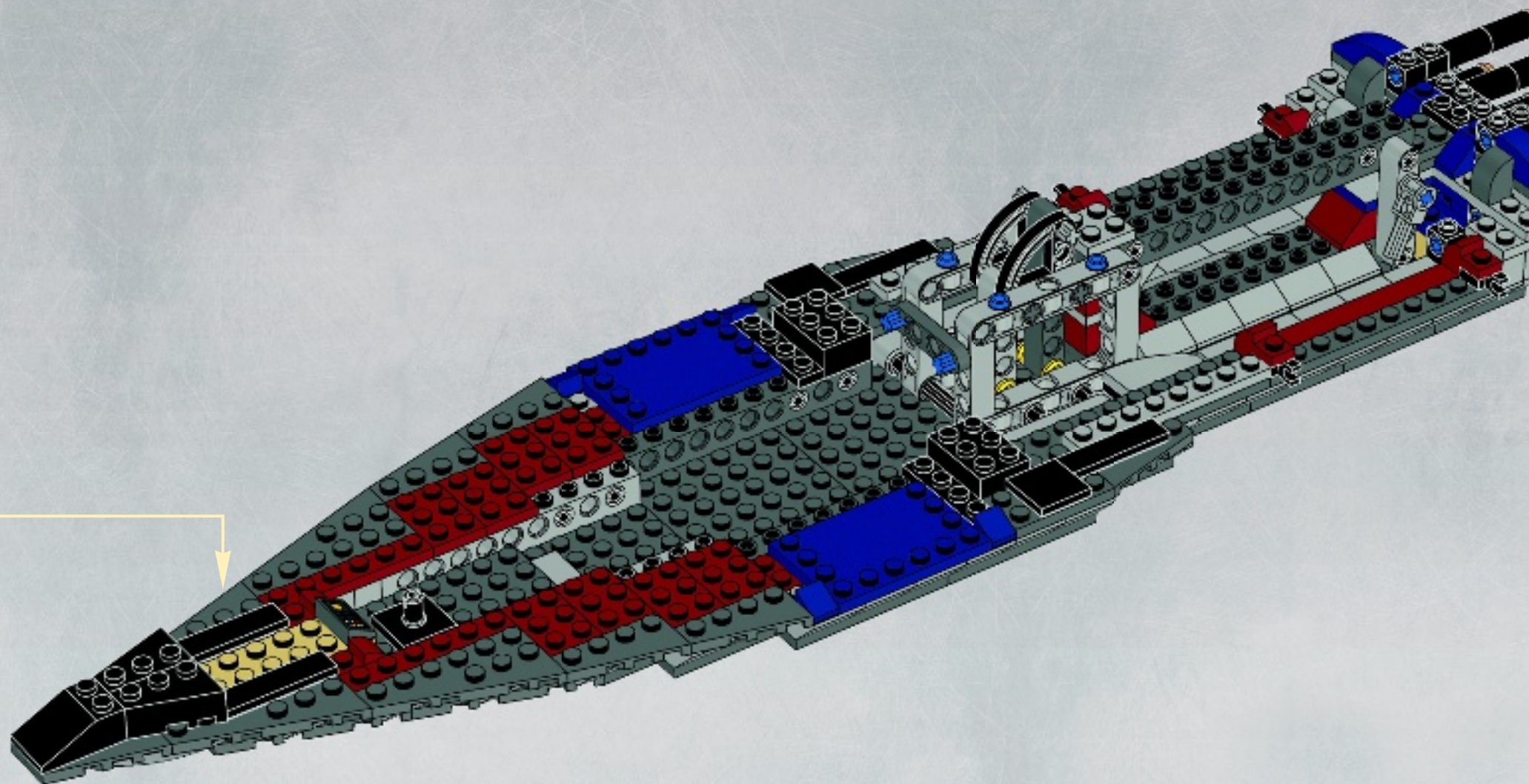





8x

33

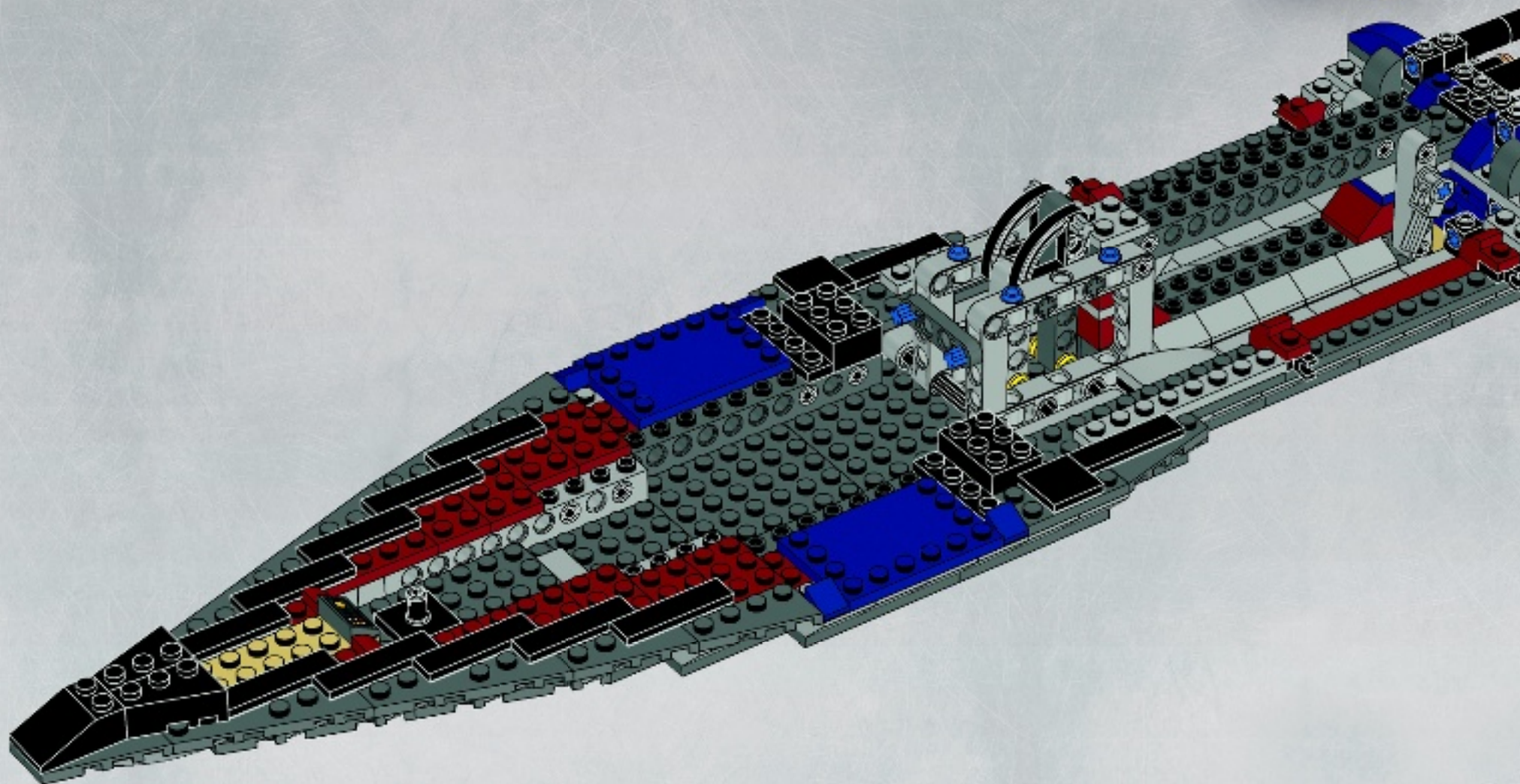



2x



2x



1x

# 34

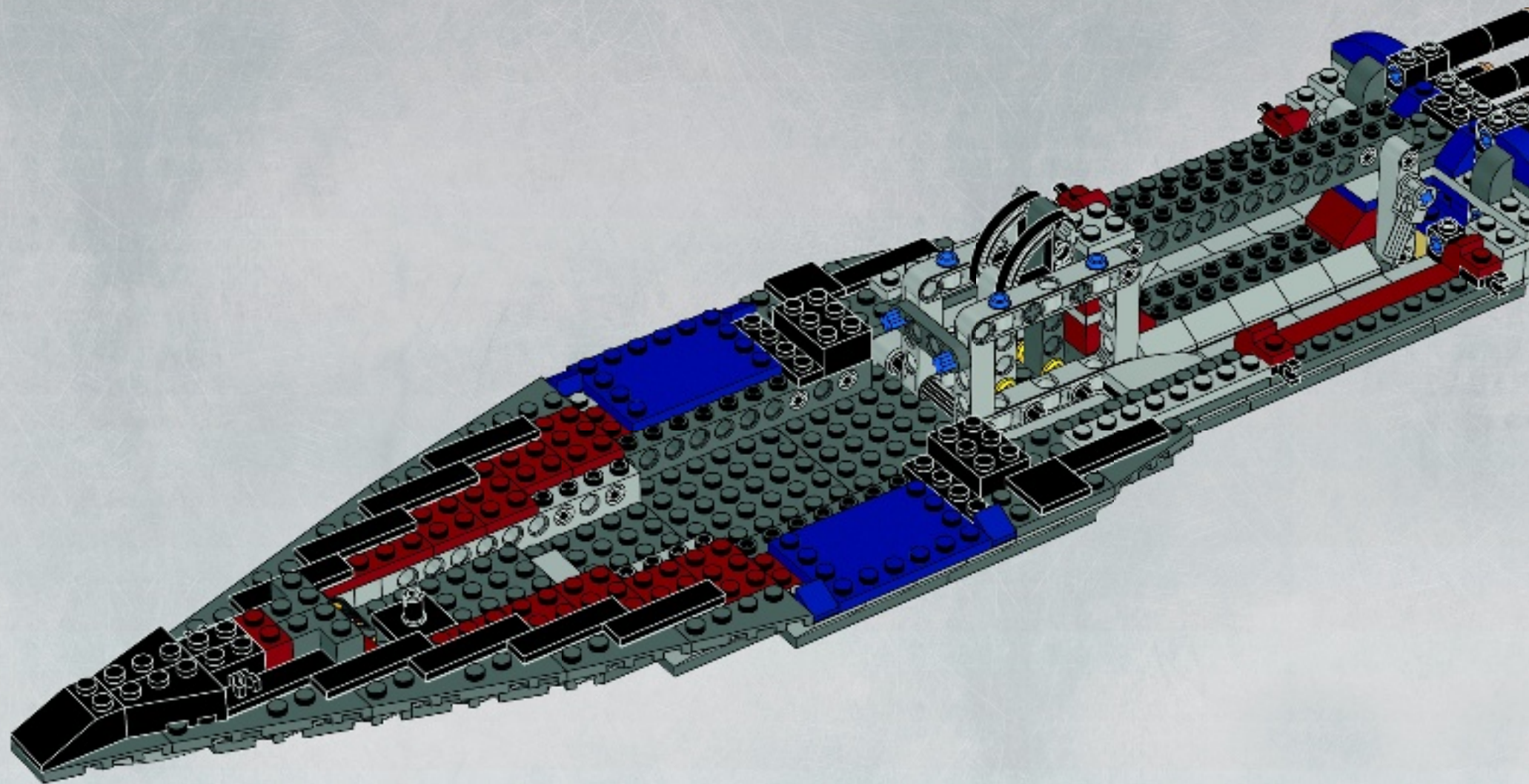

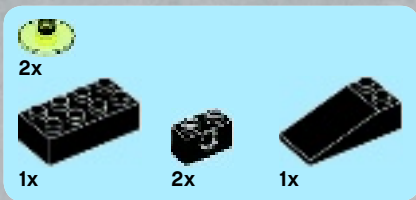

35

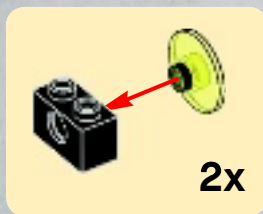
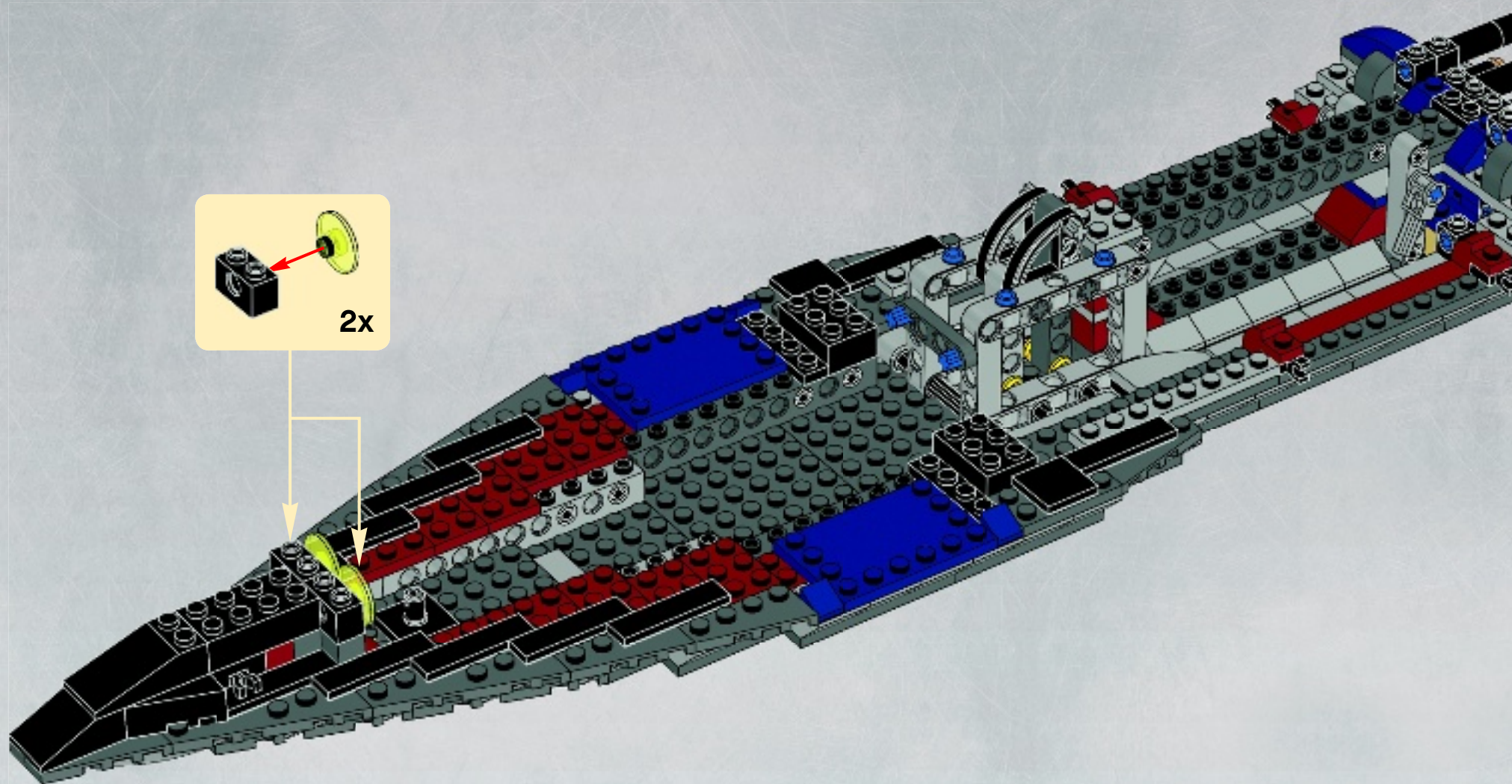

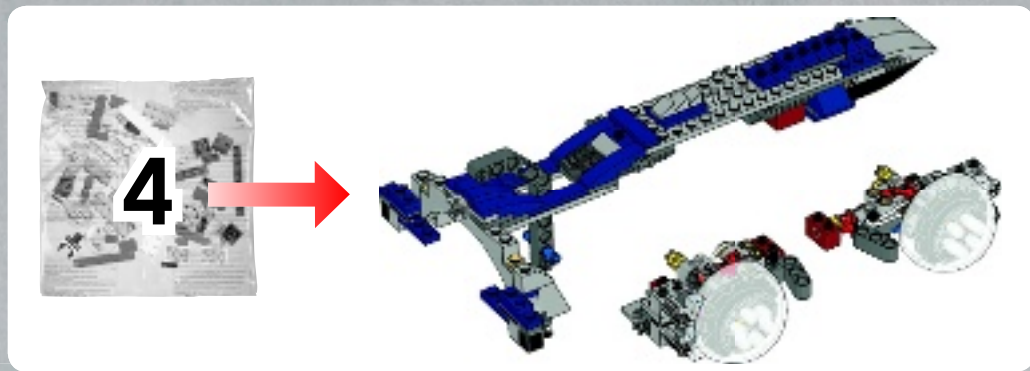

36

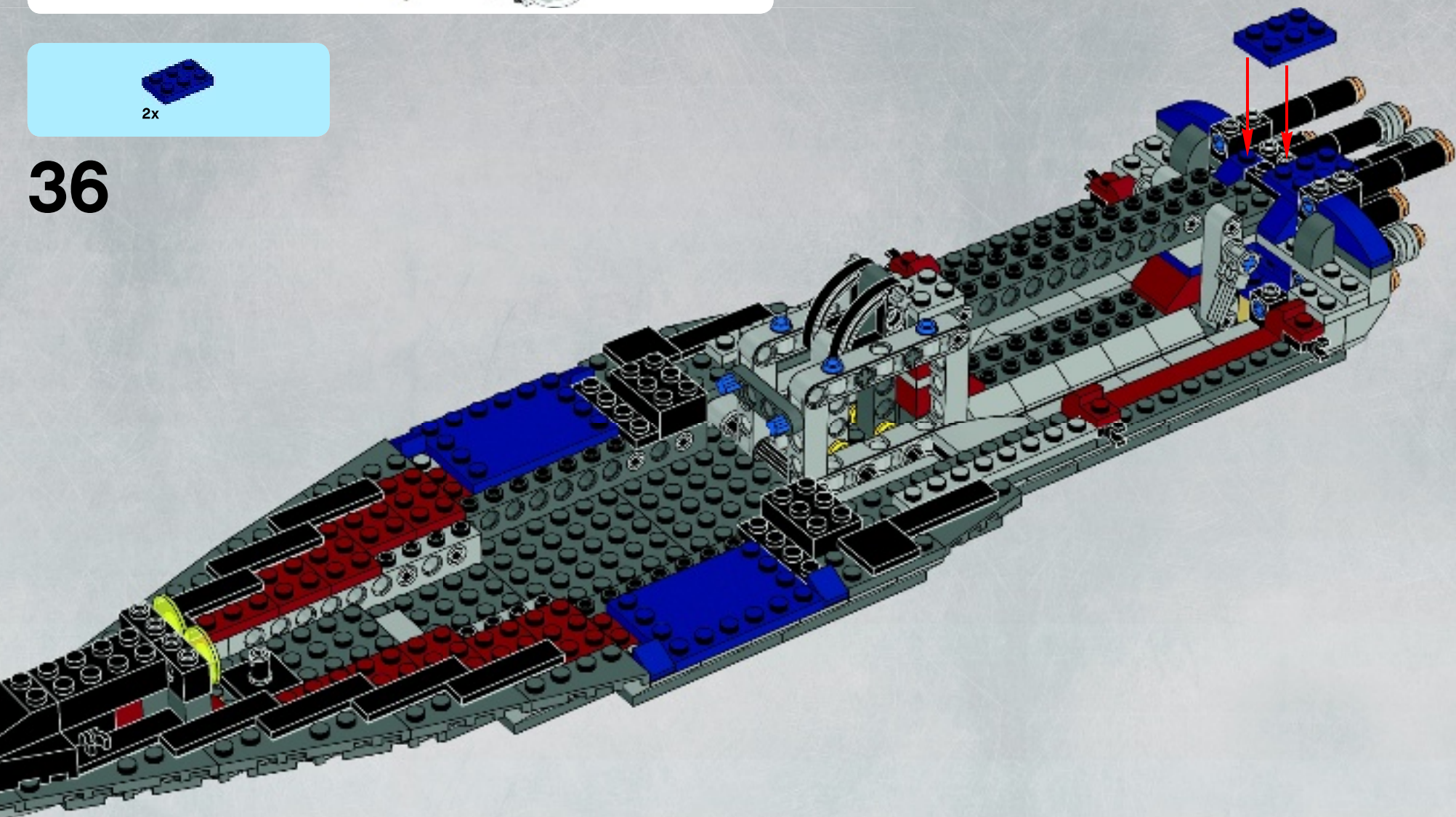

1x  1x 

37

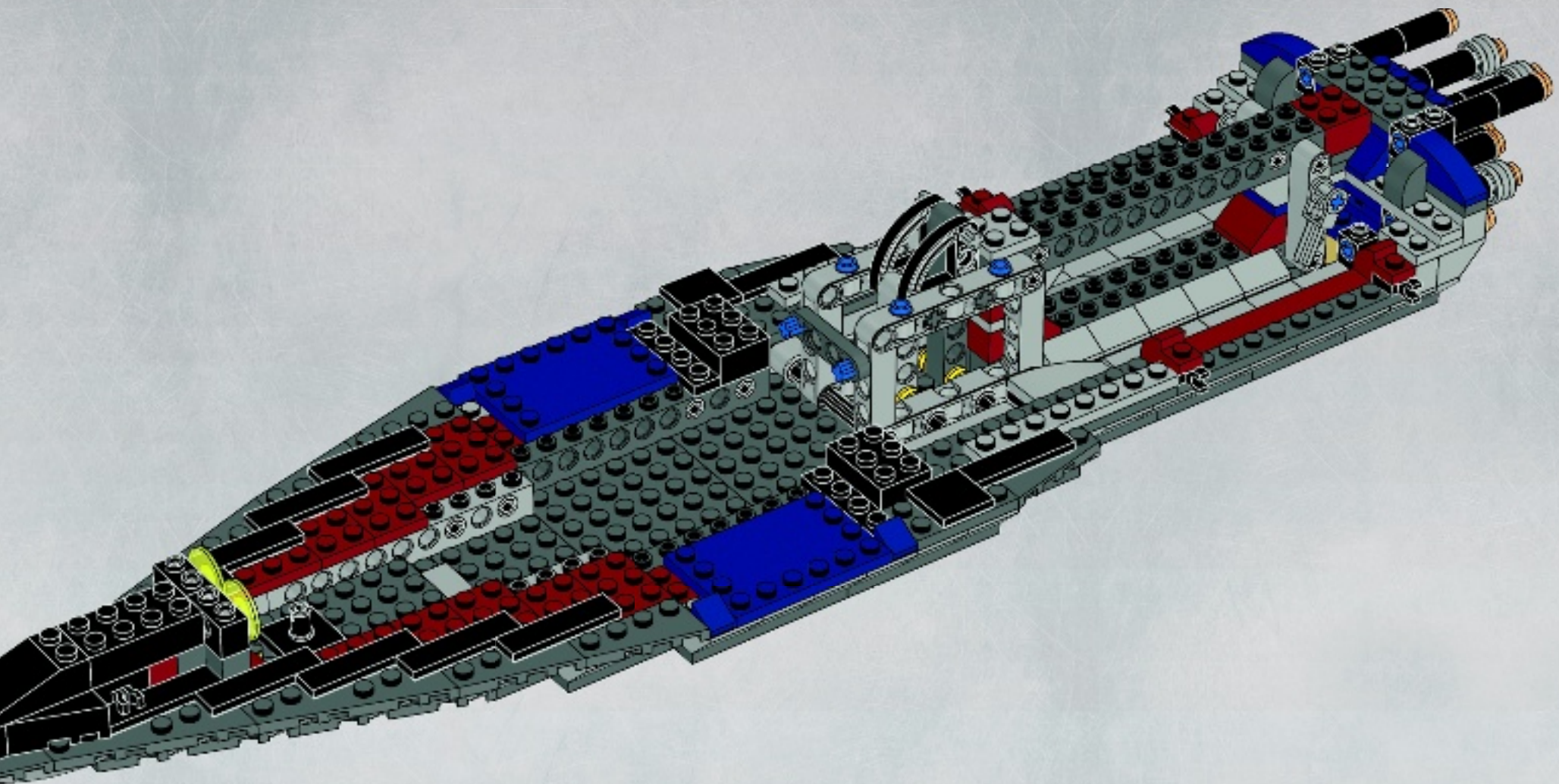



2x

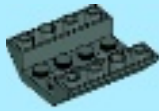

2x

# 38

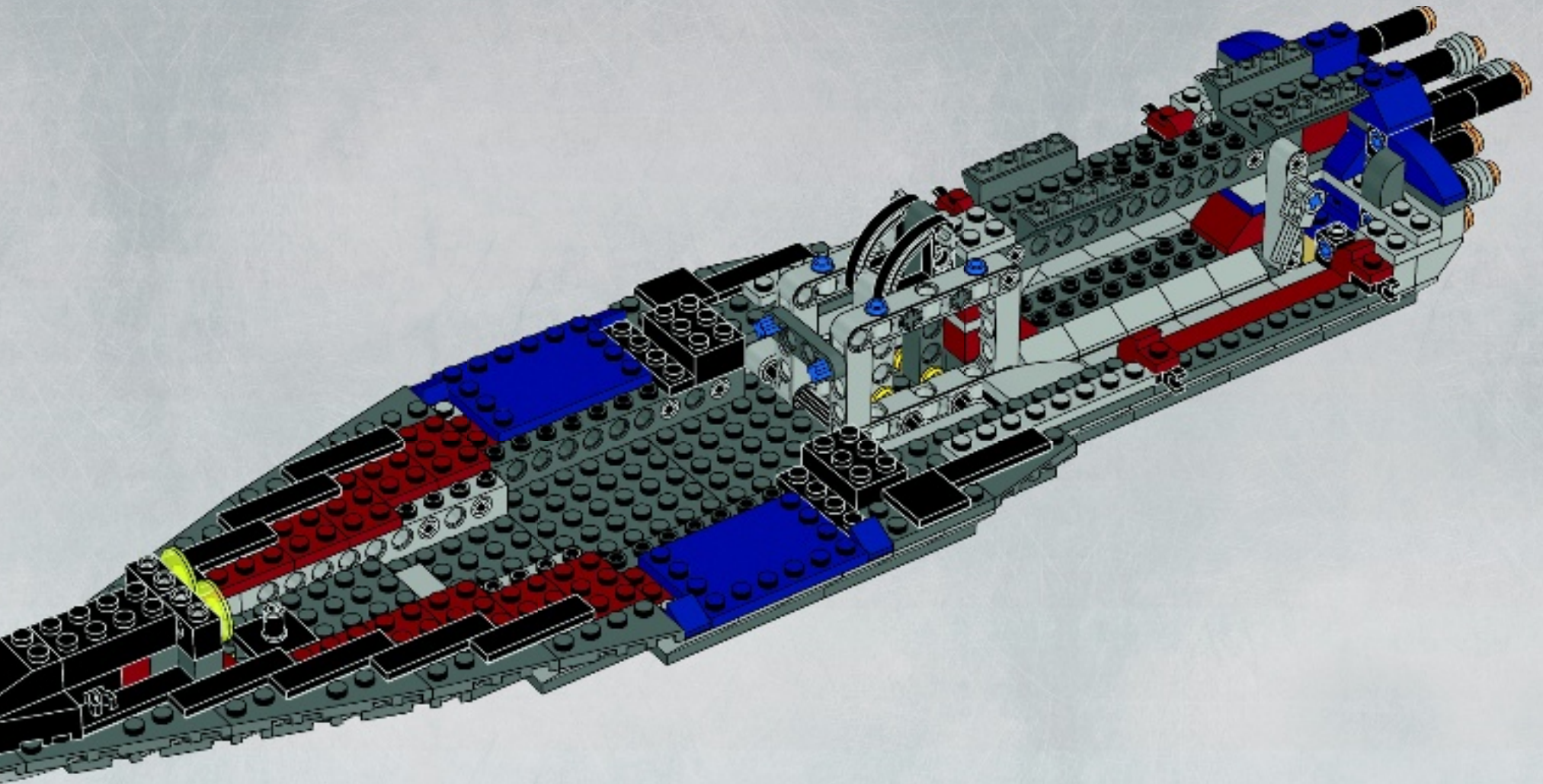

2x  2x 

39

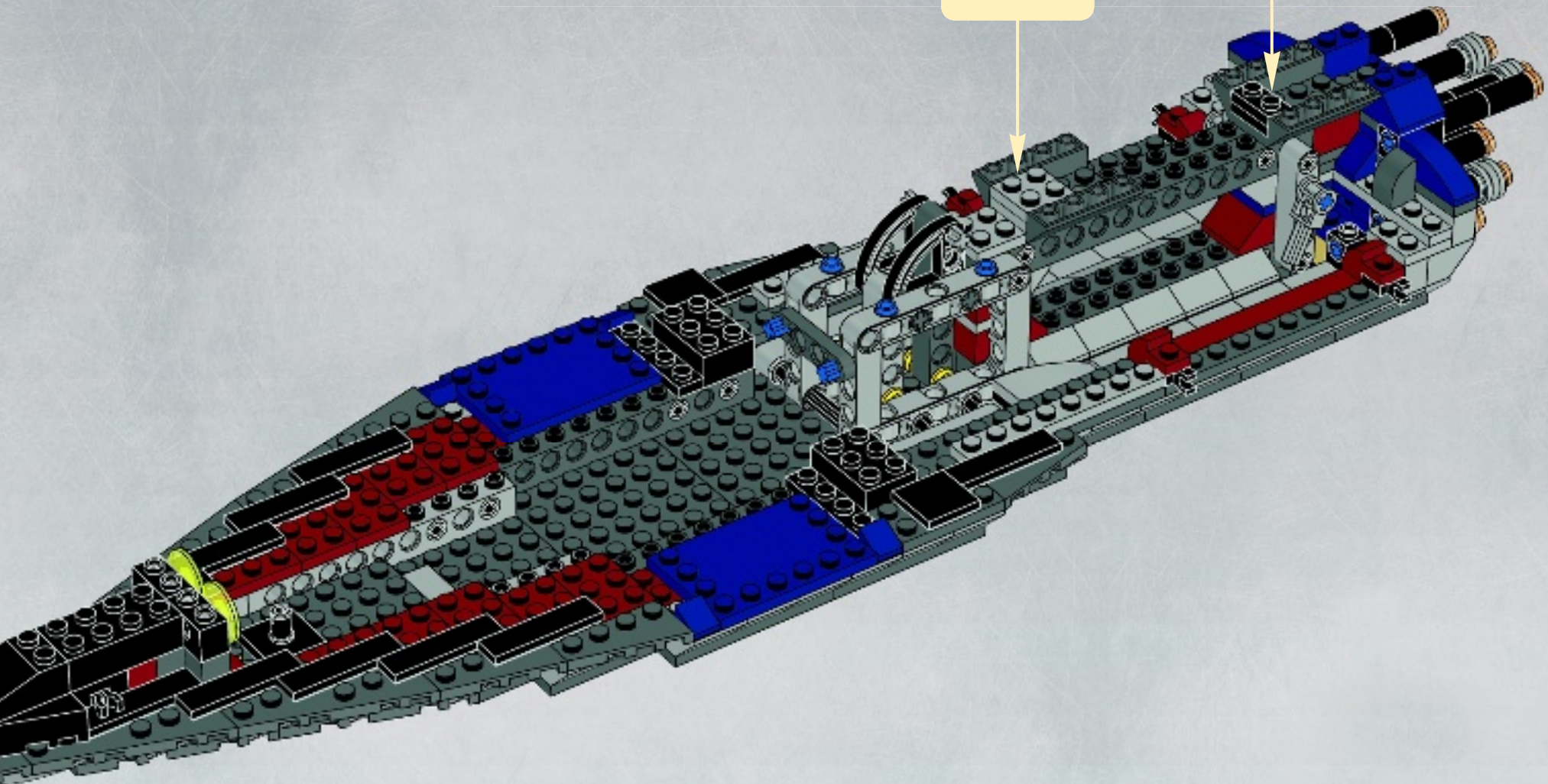
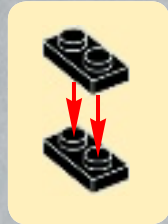
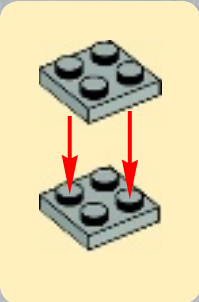

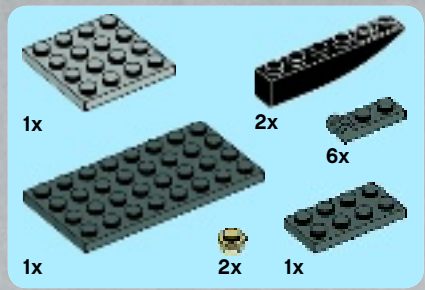

40

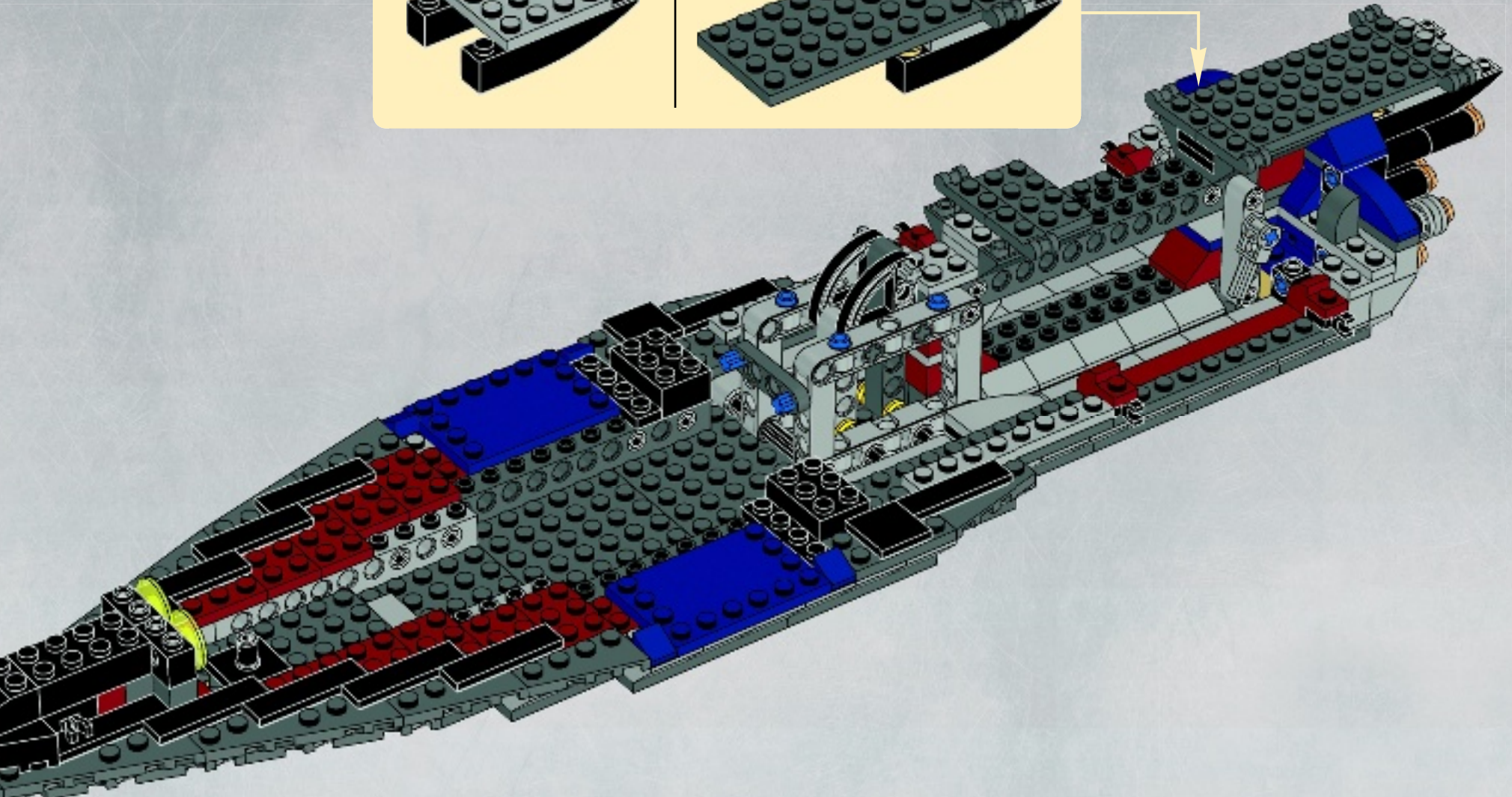
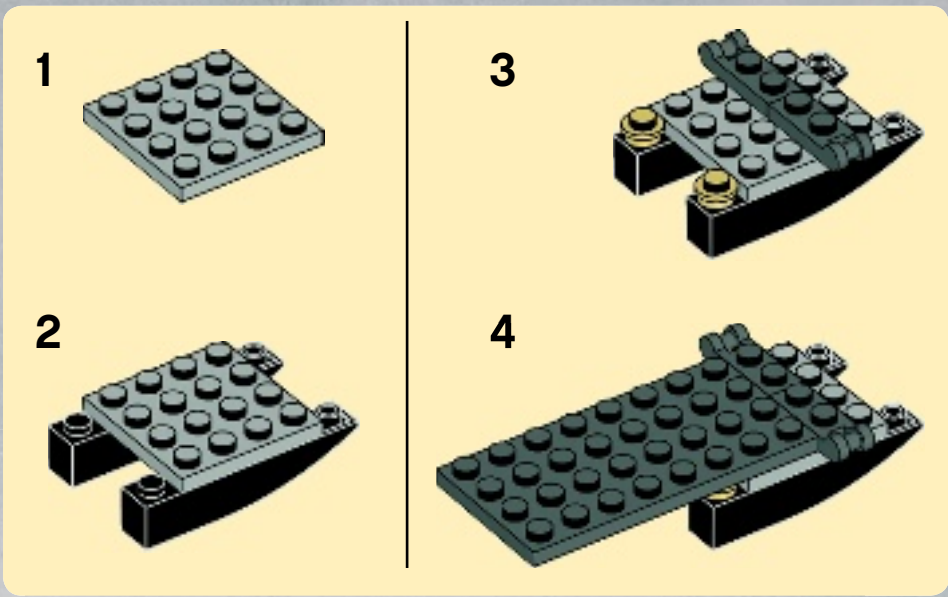



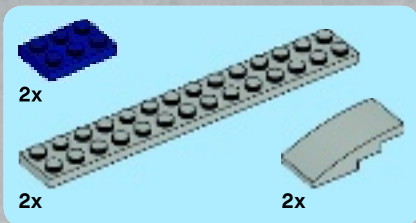

41

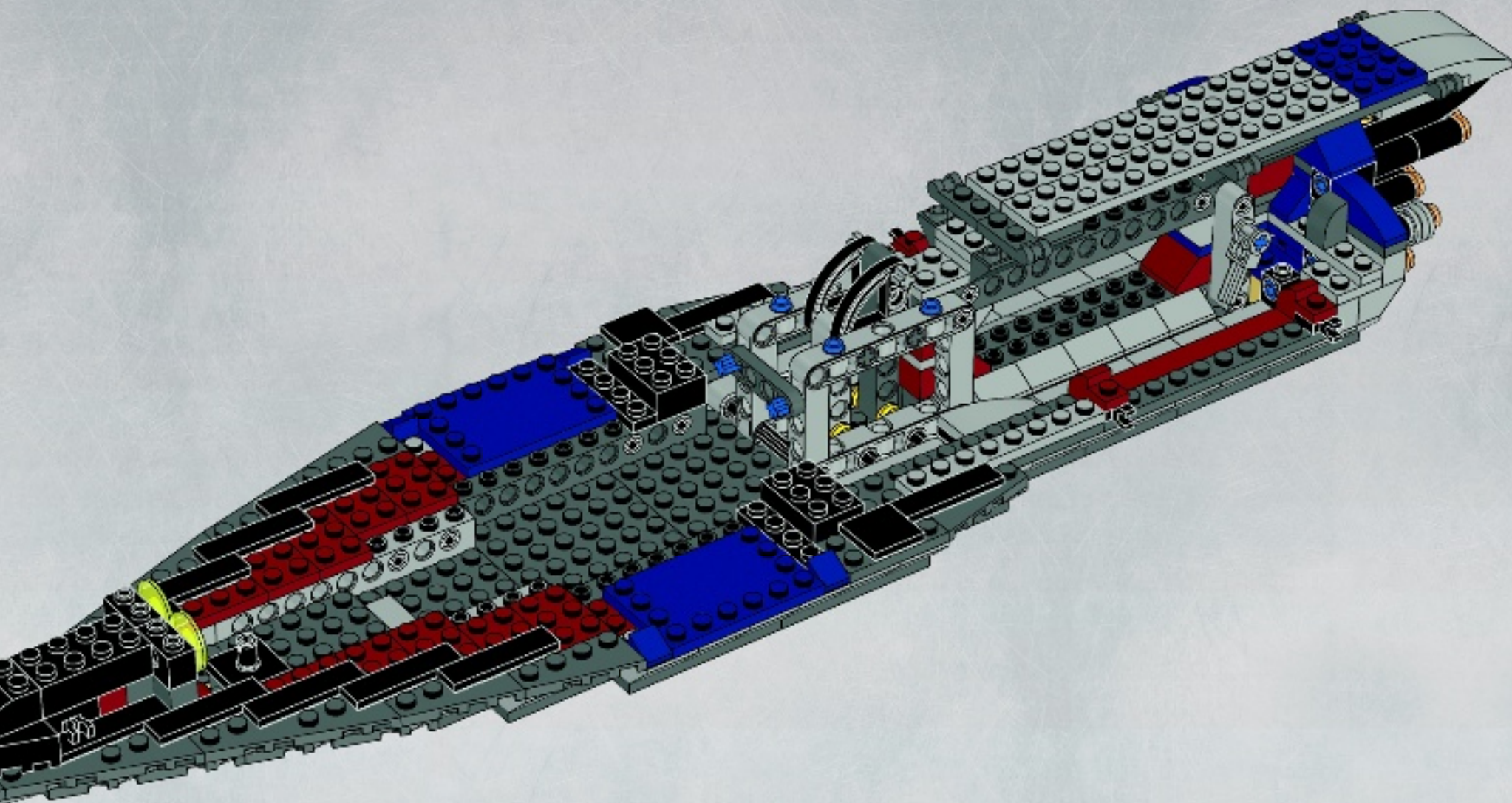

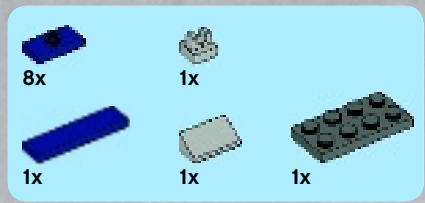

# 42

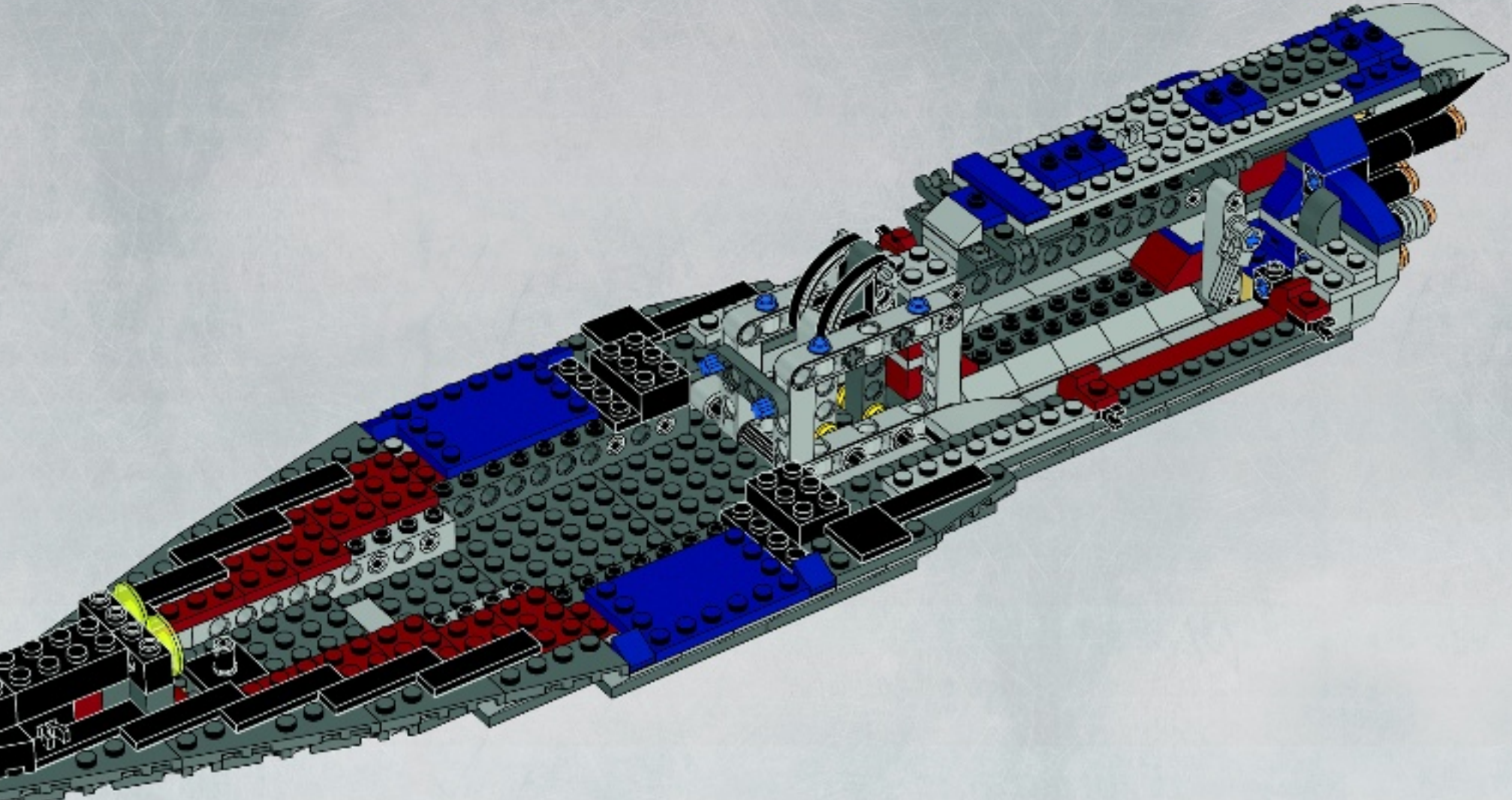



4x



3x

# 43

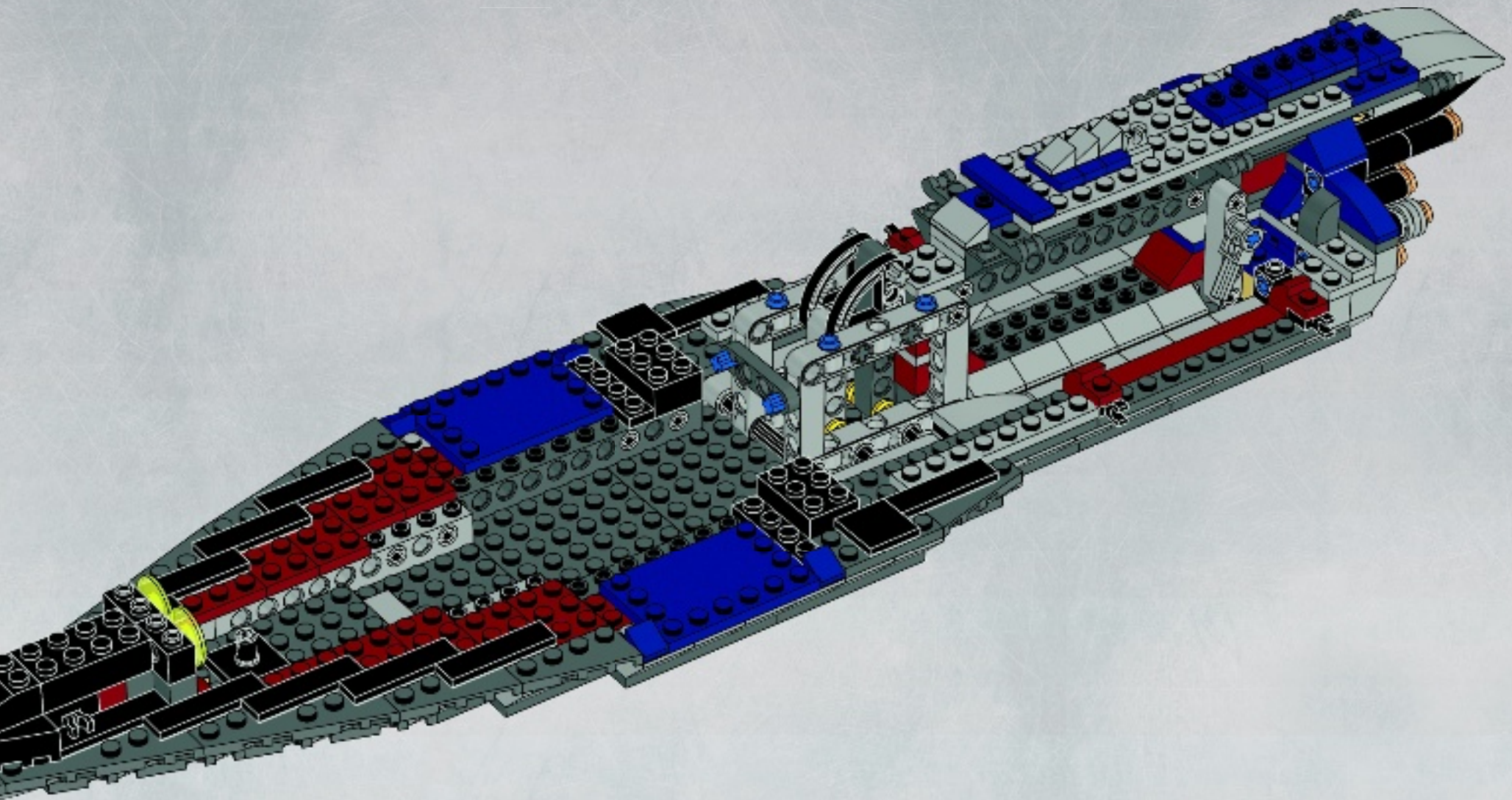

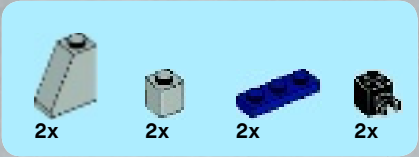

44

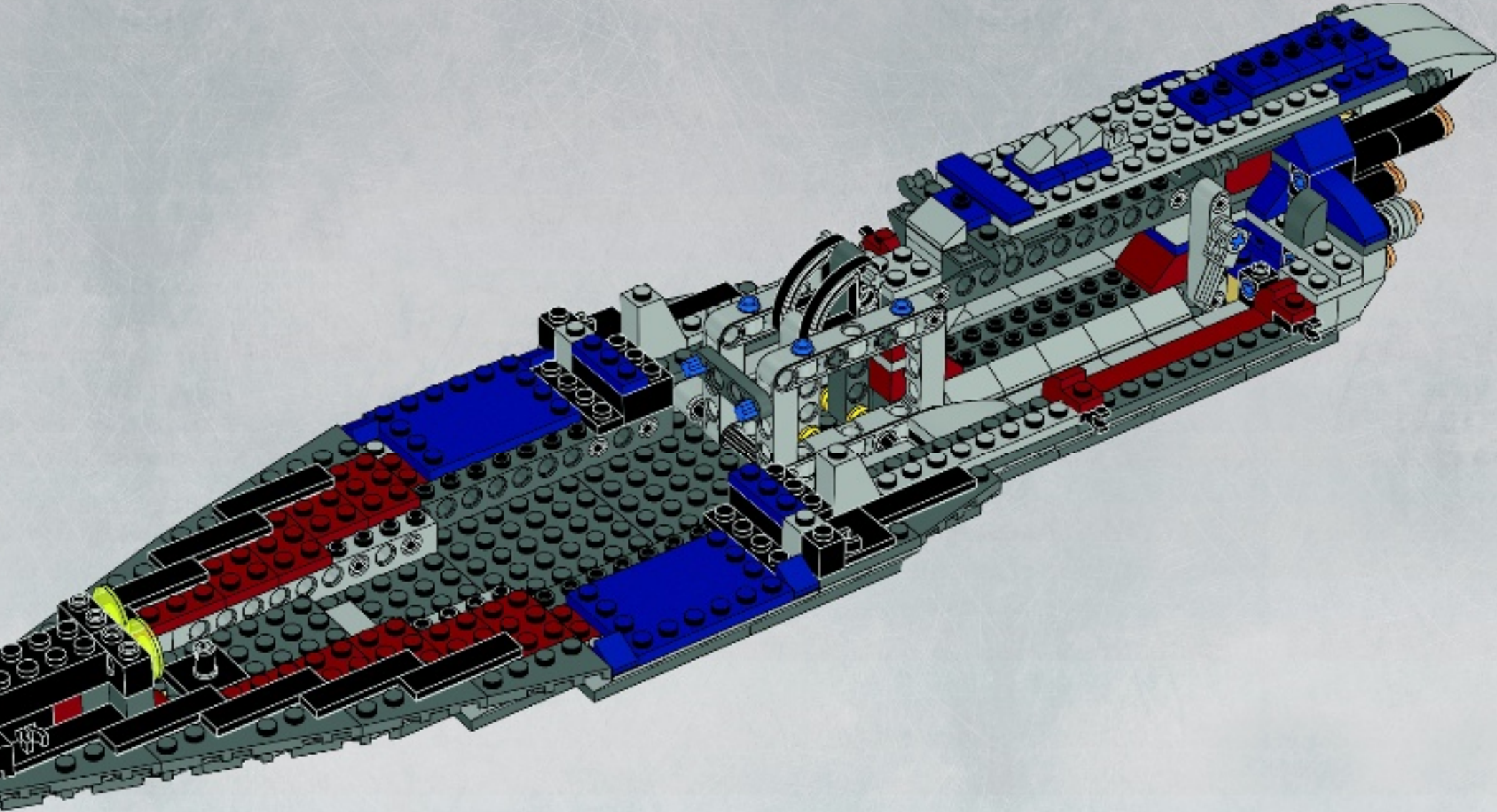

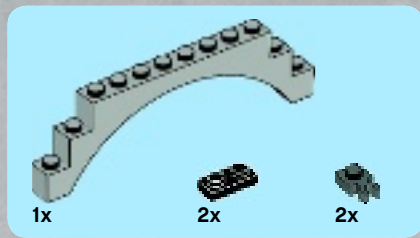

45

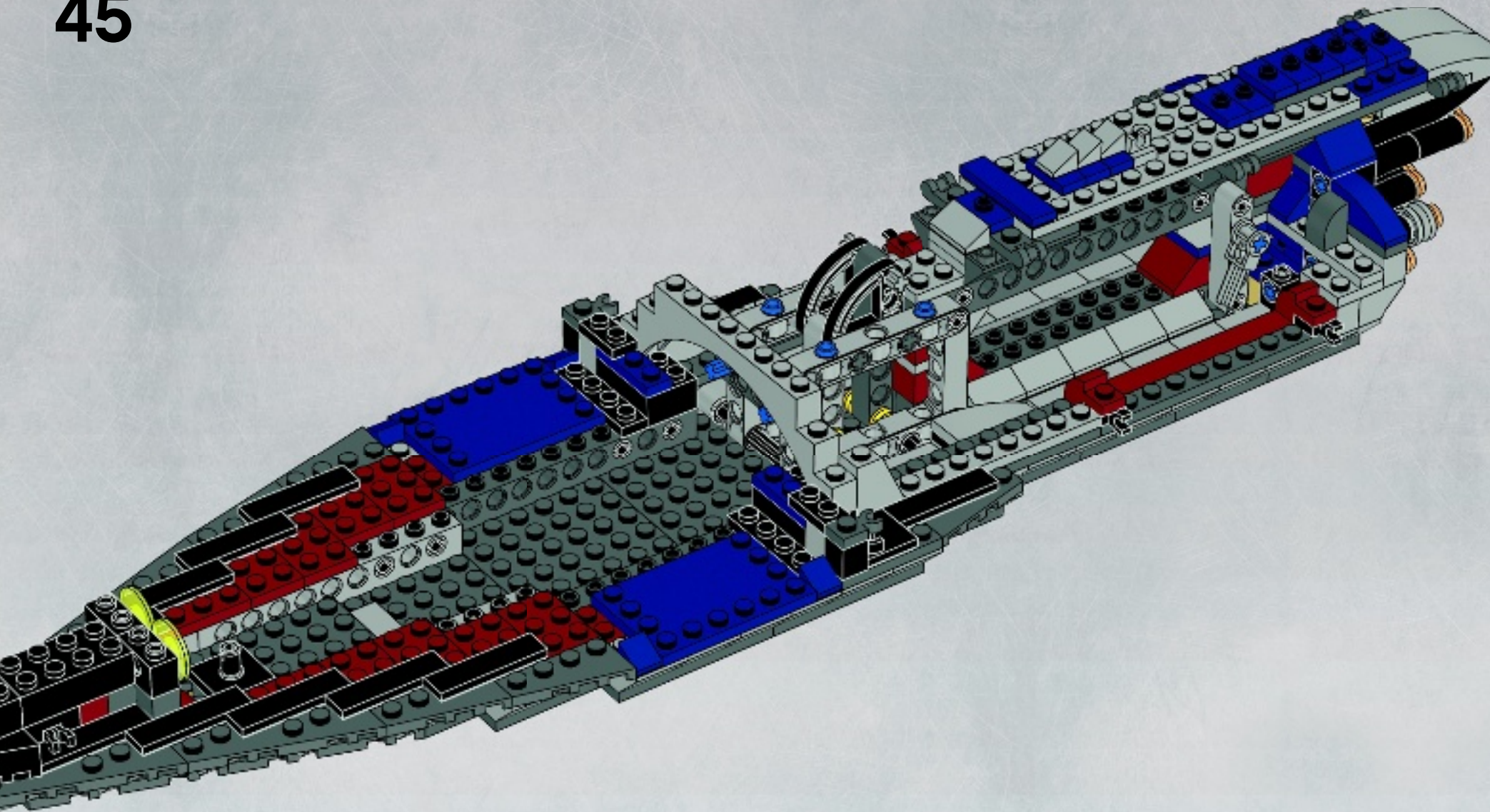

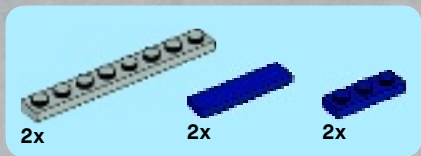

46

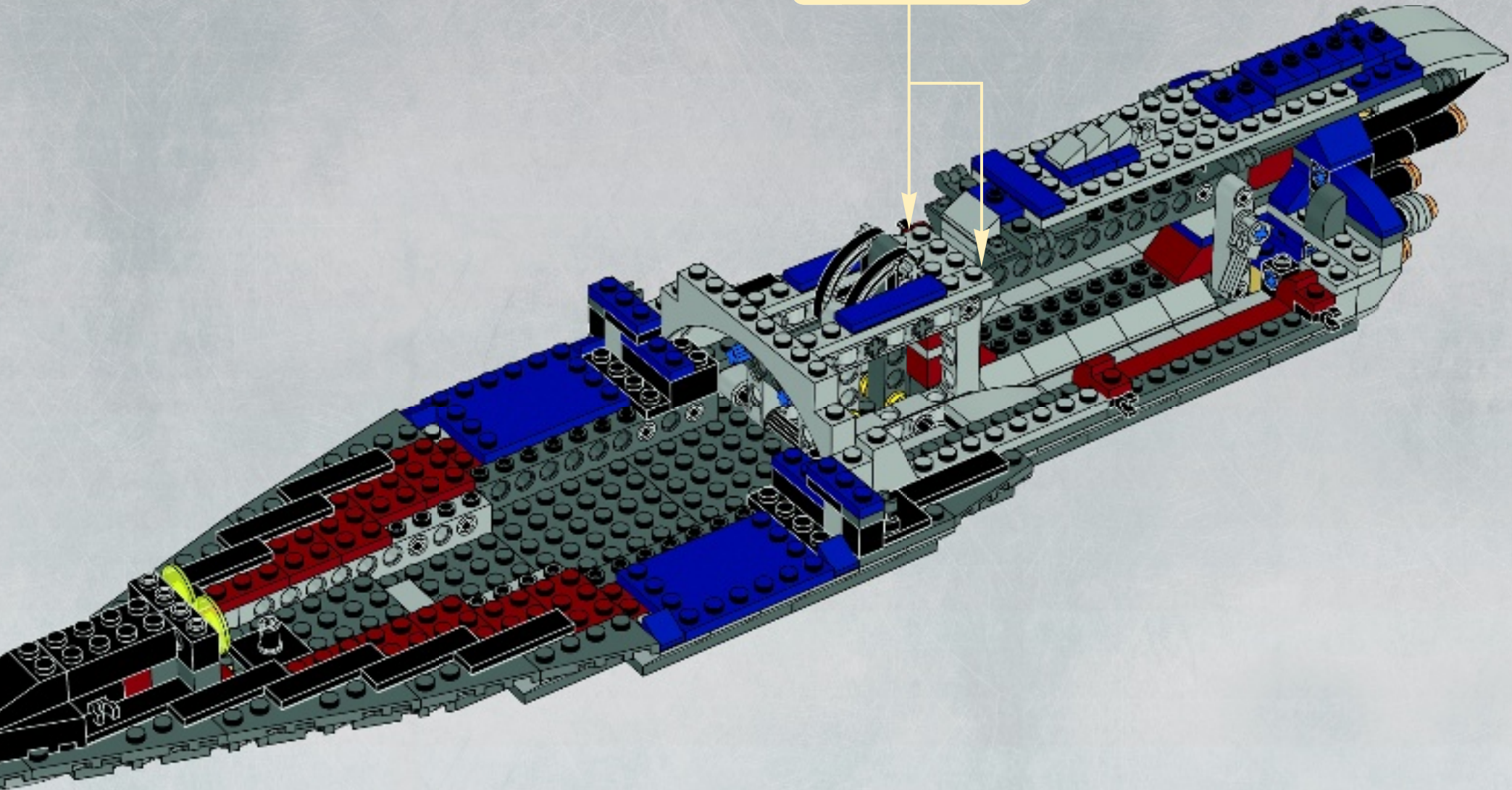
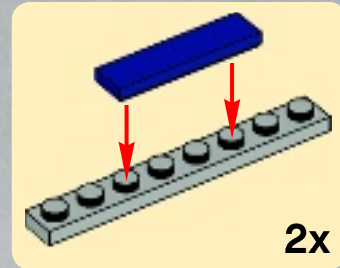

2x

2x

2x

# 47

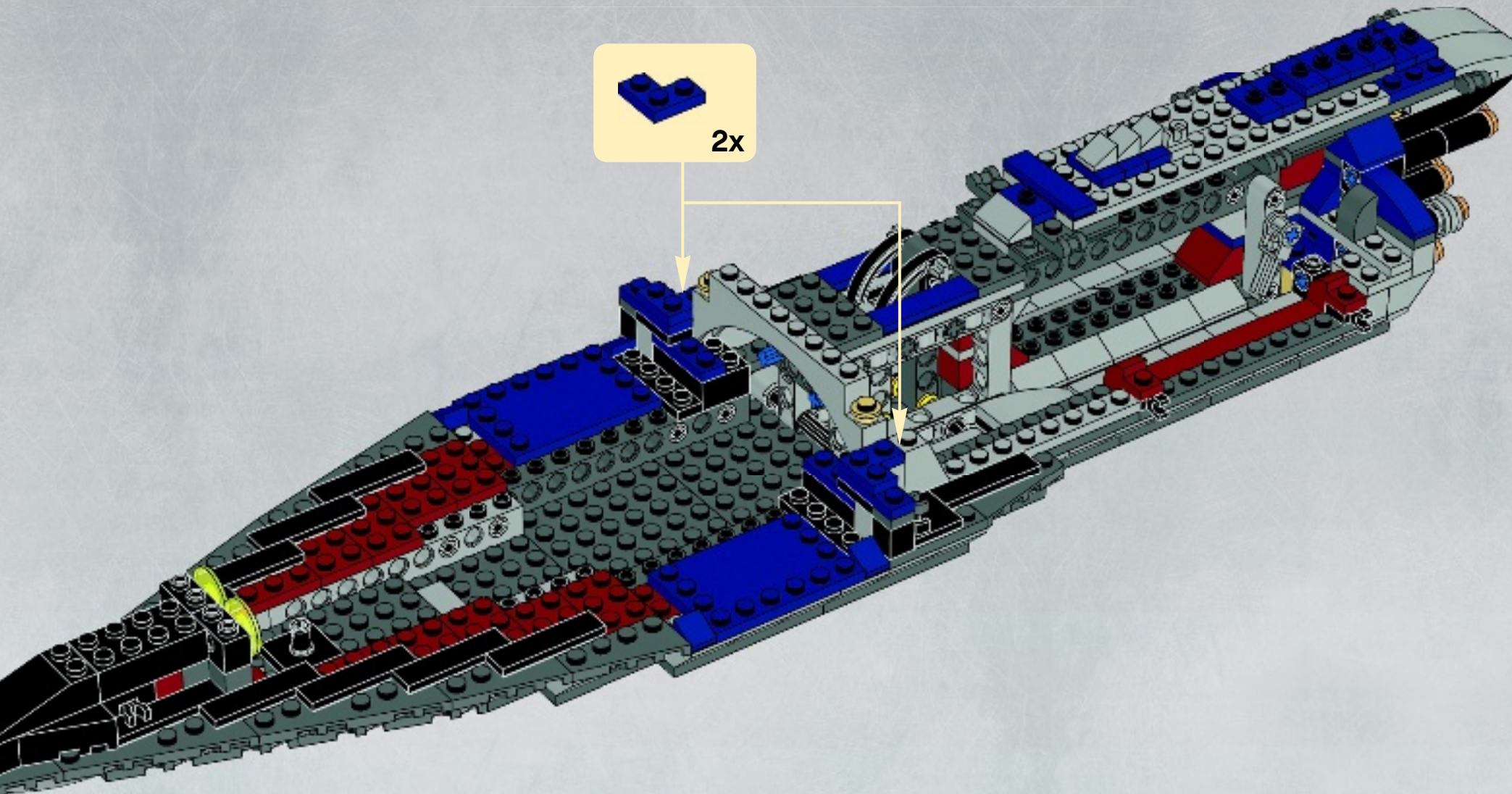

2x

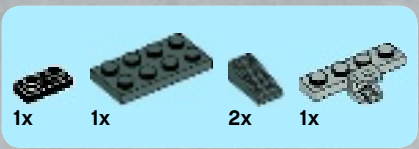

48

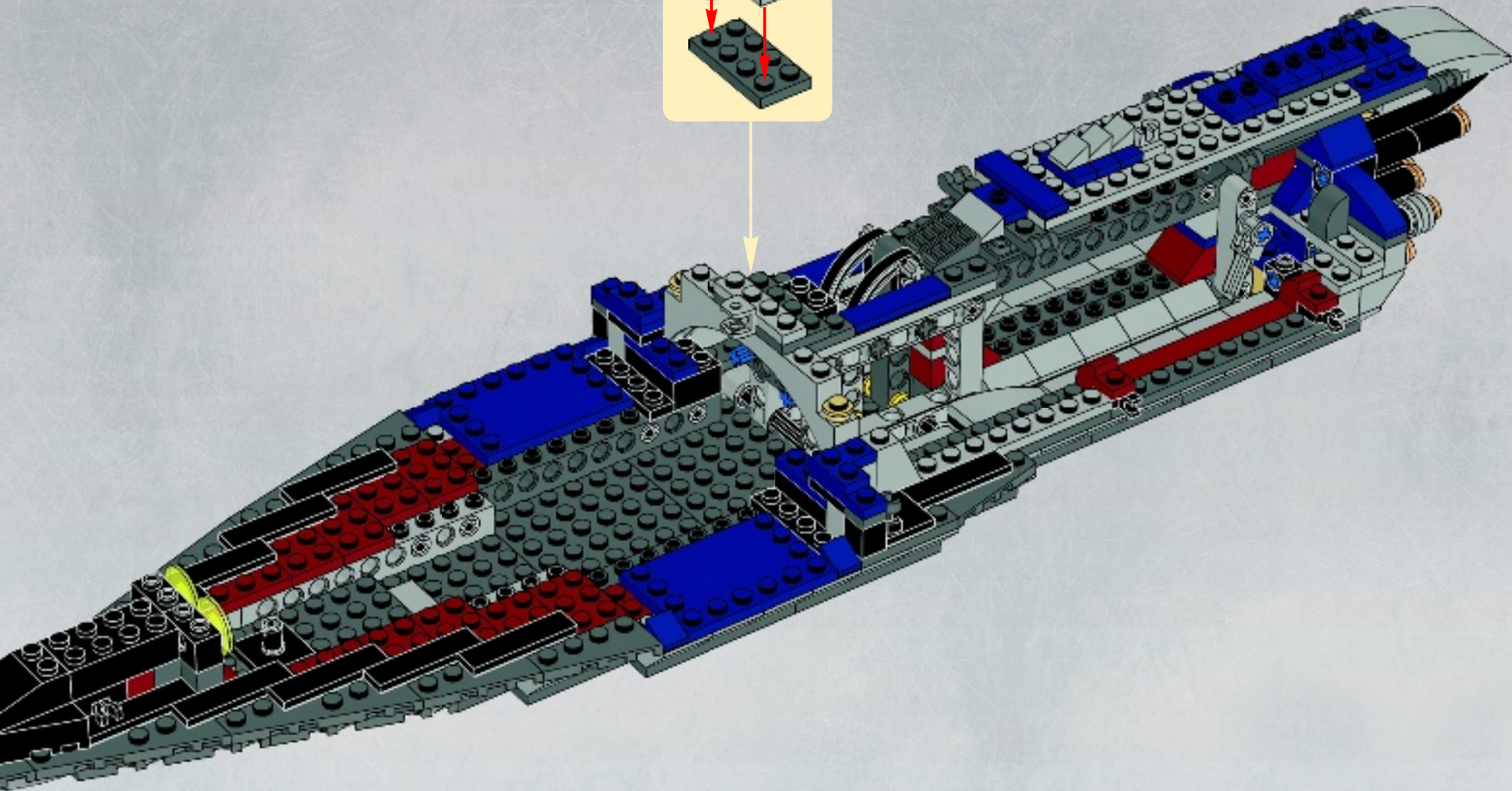
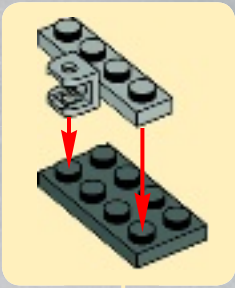



2x  2x 

49

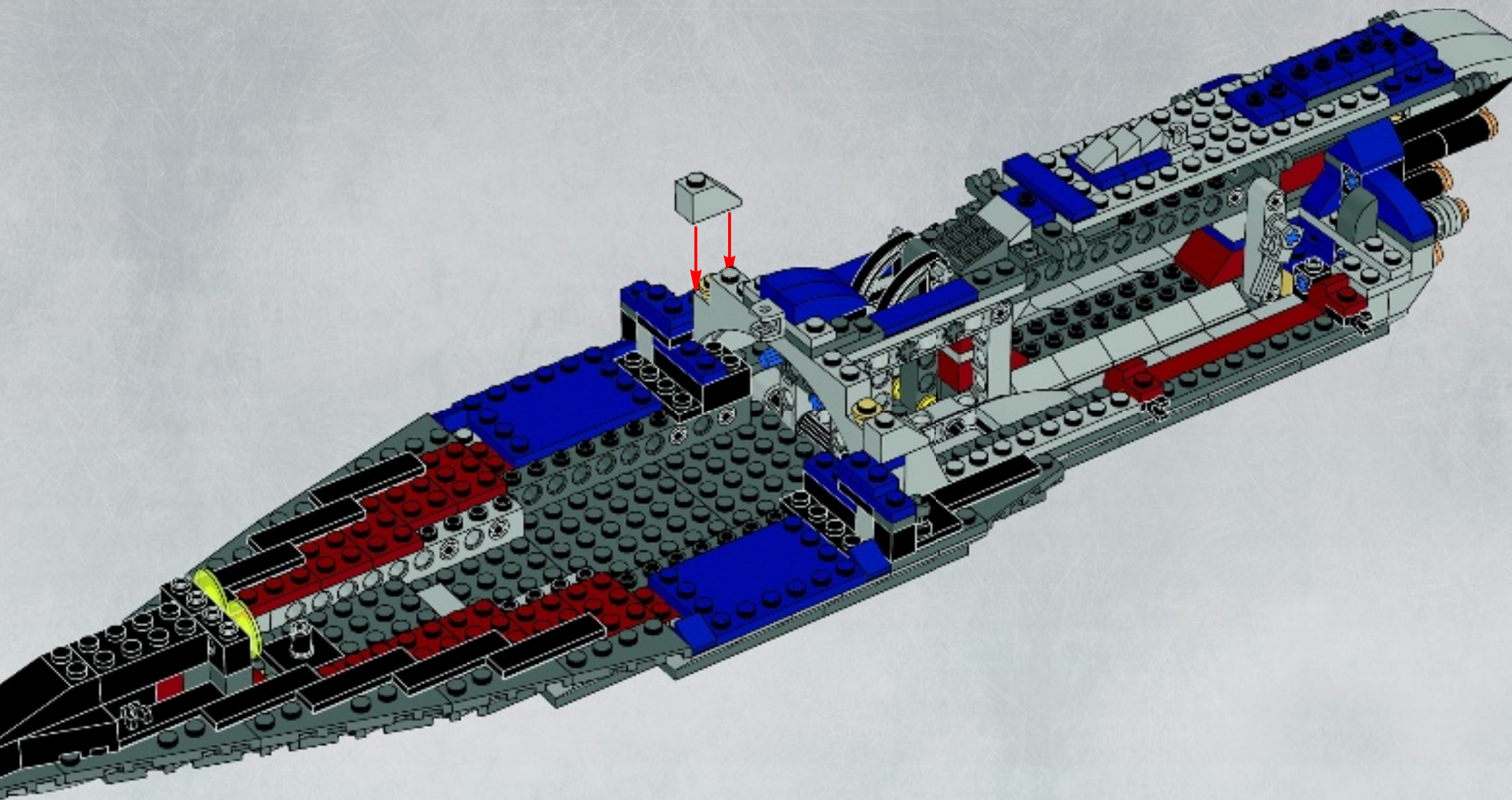



4x

# 50

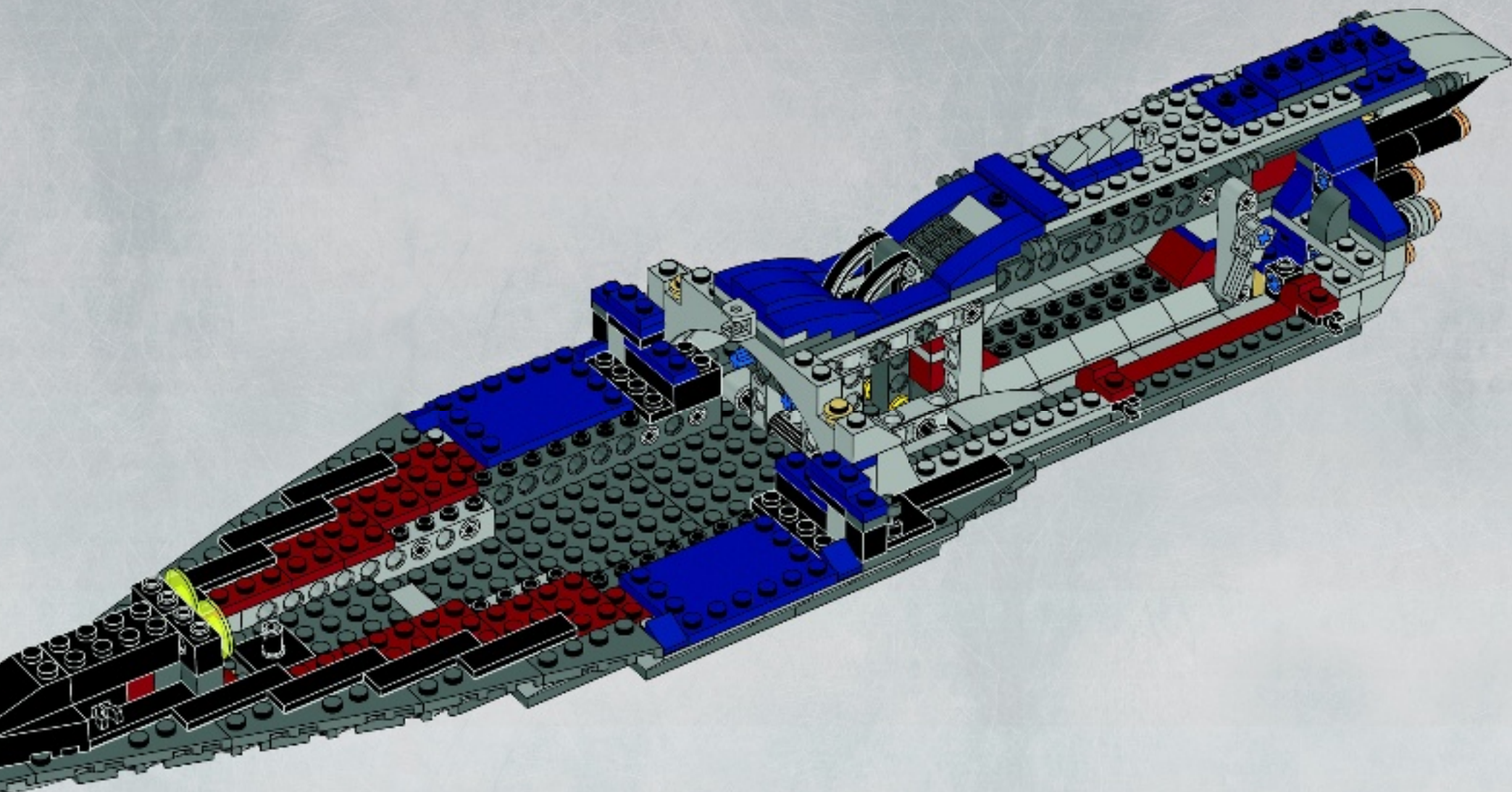

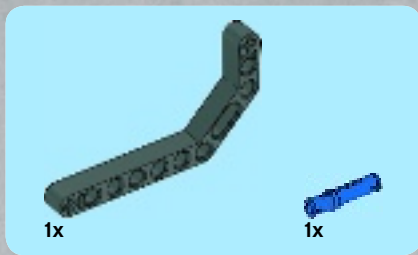

51

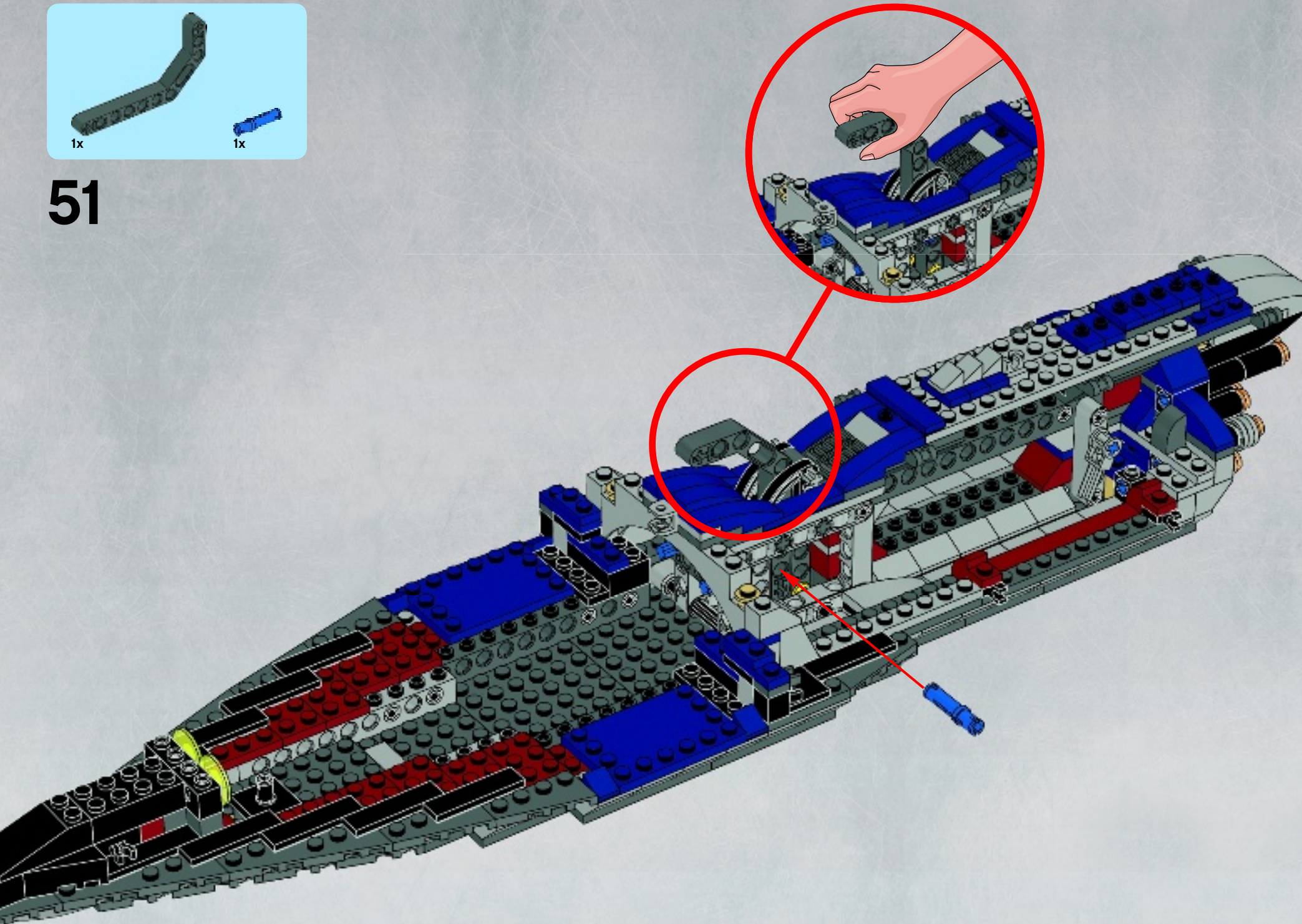

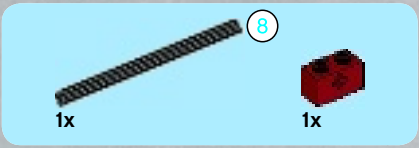
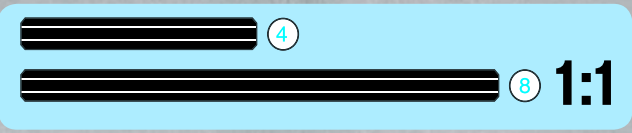

1

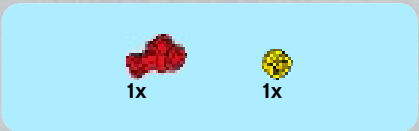
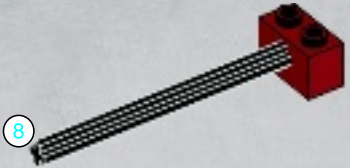

2

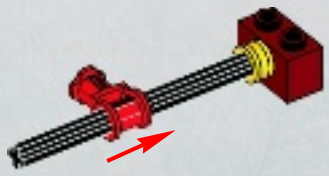

3

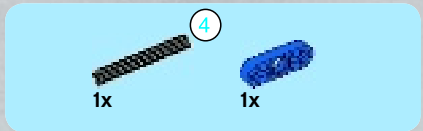
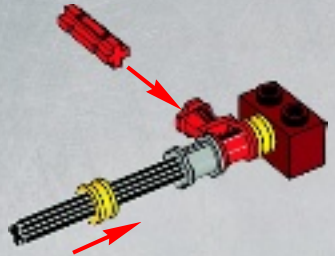

4

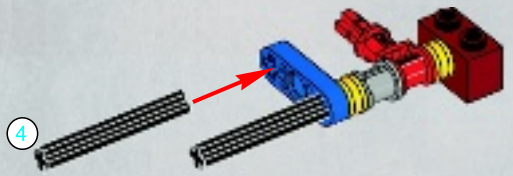

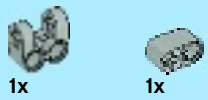

1x

1x

5

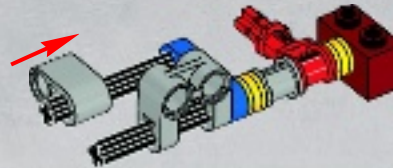

1x

2x

7

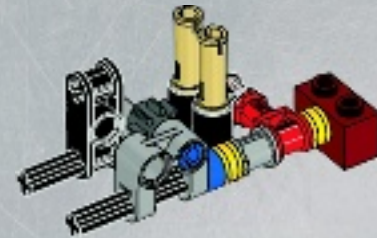

1x

1x

1x

6

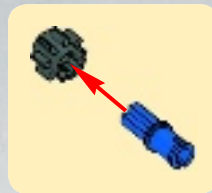

1x

1x

8

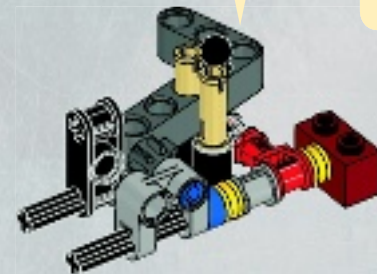
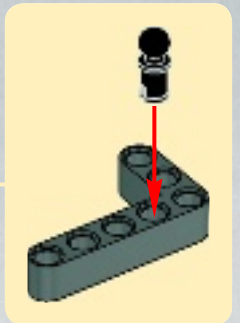



9

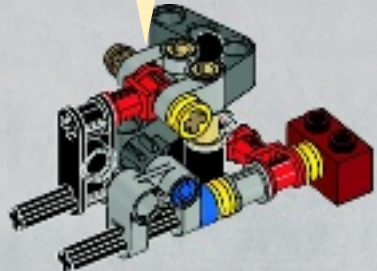
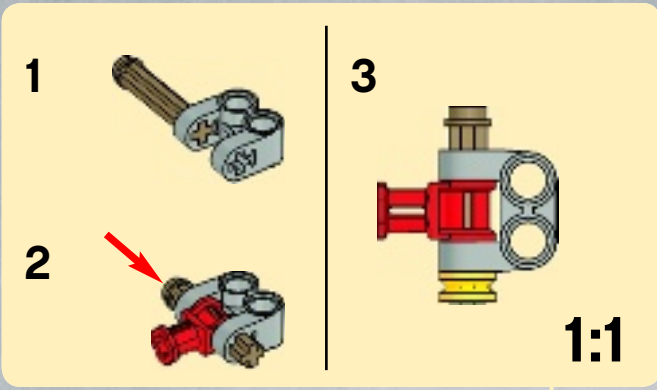

10

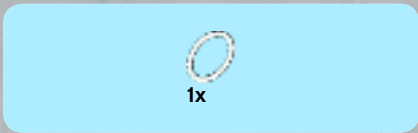
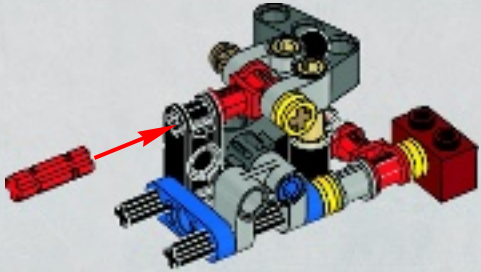

11

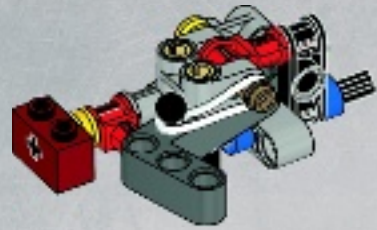

12

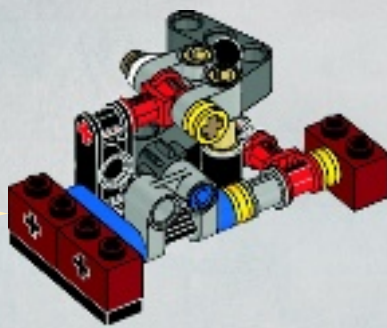
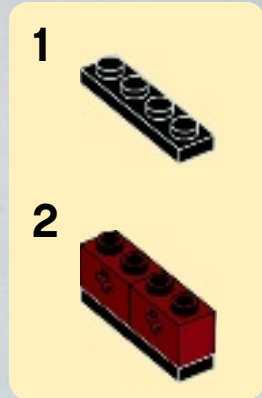

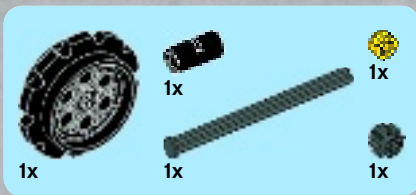

13

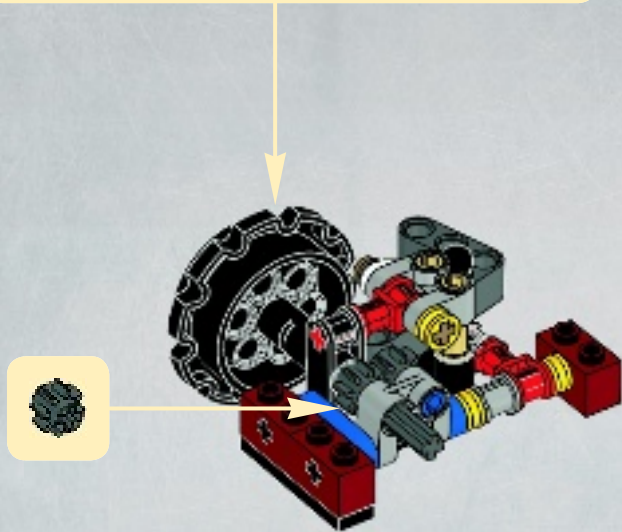
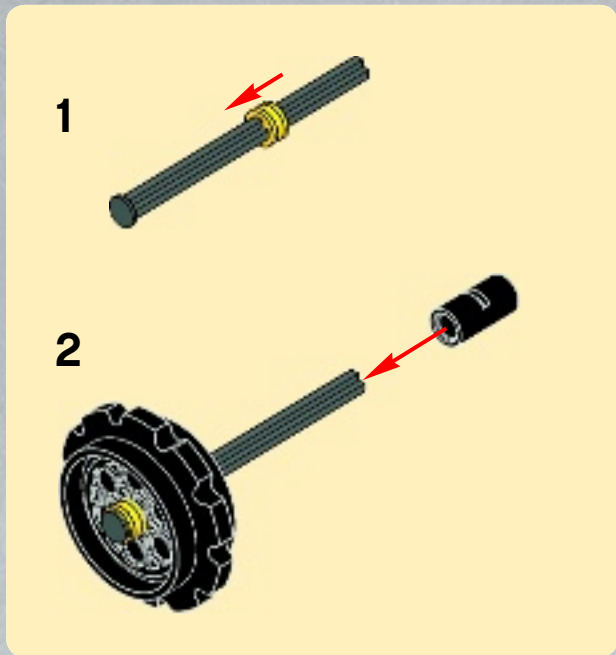

14

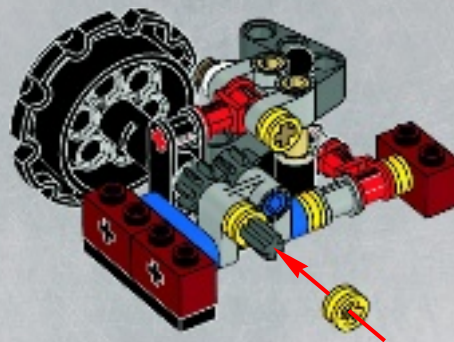

15

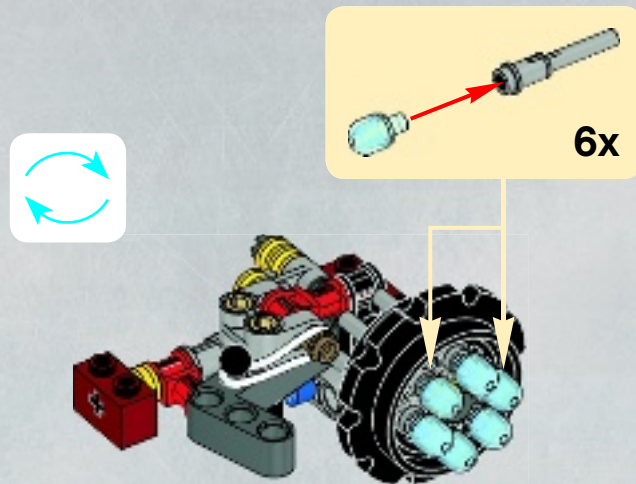

52

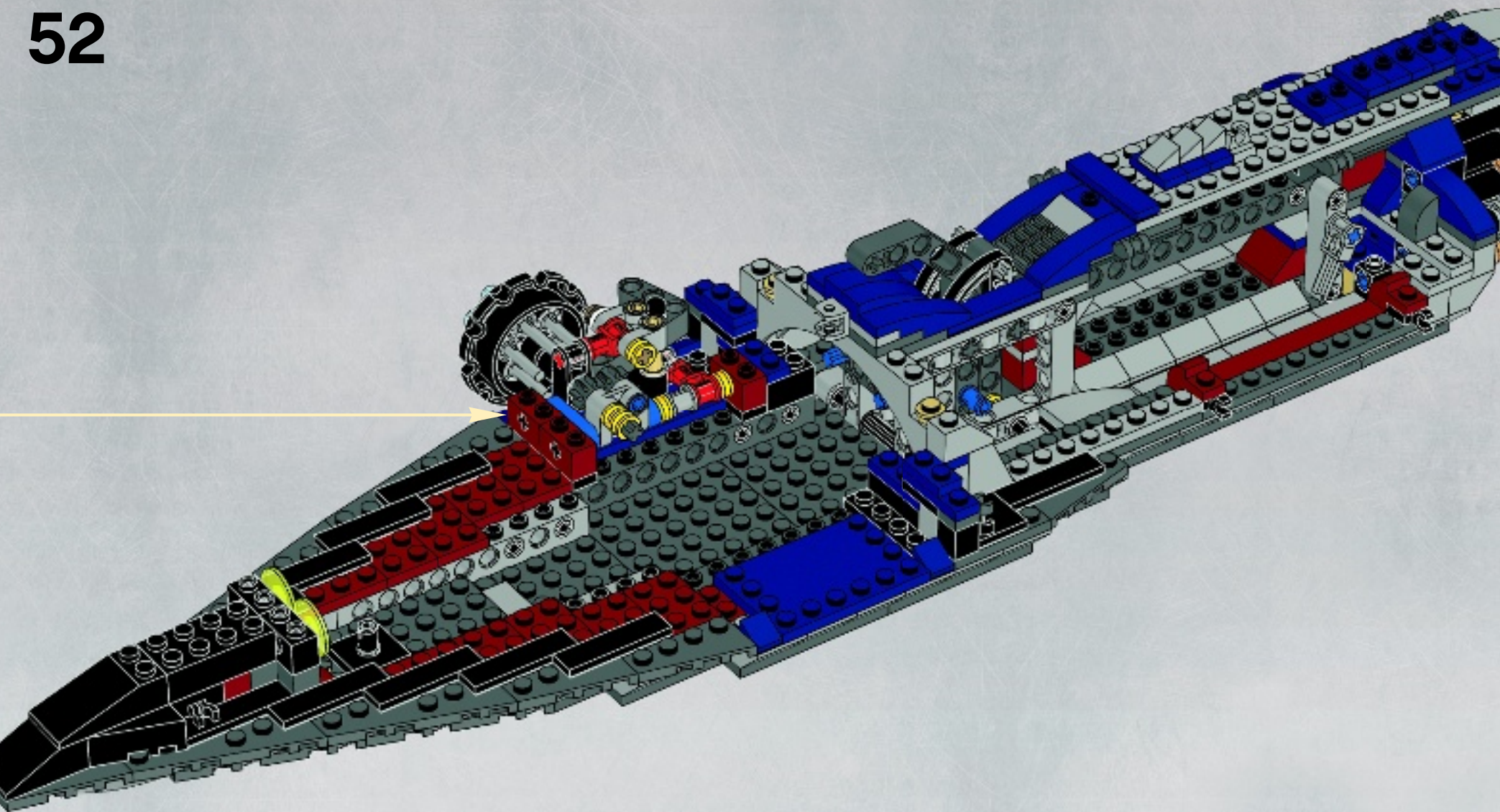



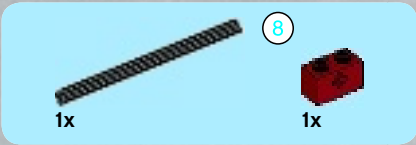

1

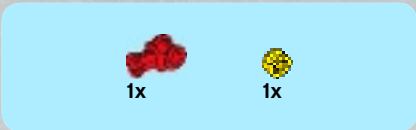

2

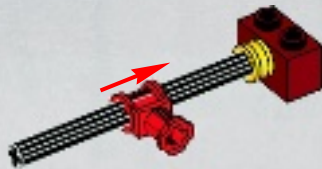

3

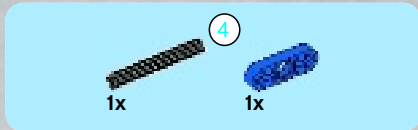
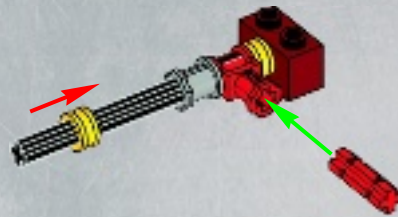

4

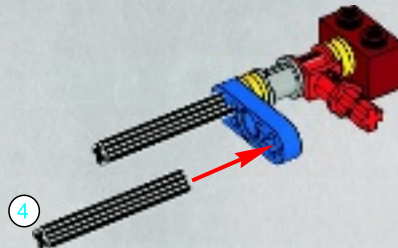



1x



1x

5

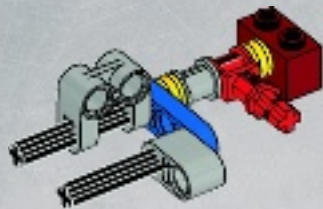

1x



2x

7

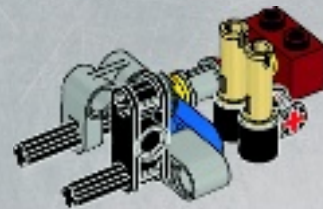

1x



1x



1x

6

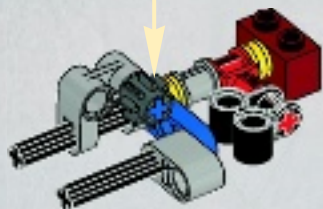
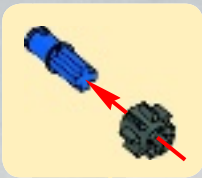

1x



1x

8

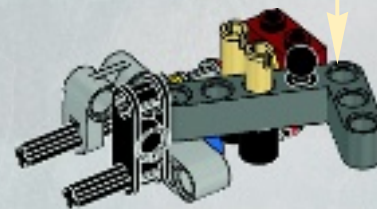
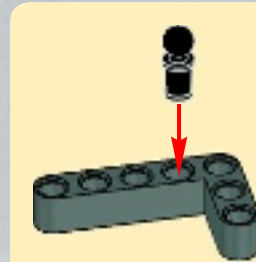



9

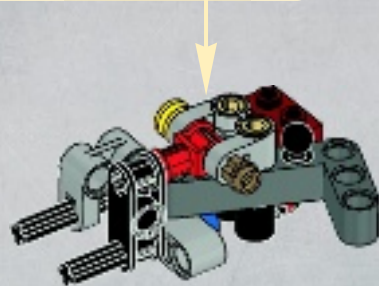
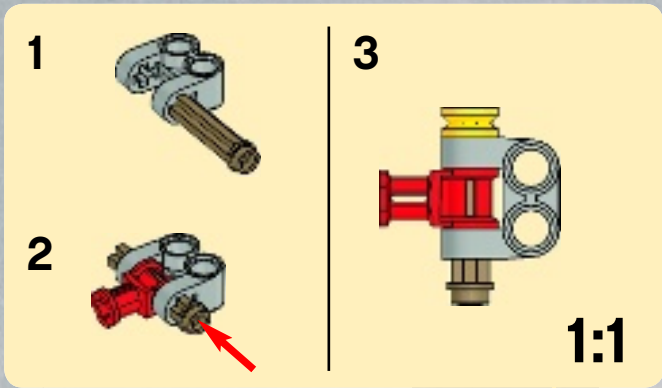

10

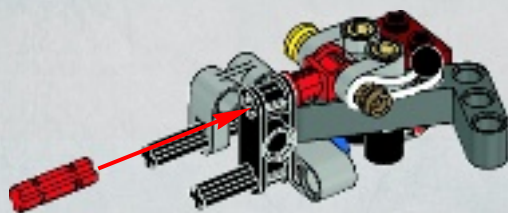

11

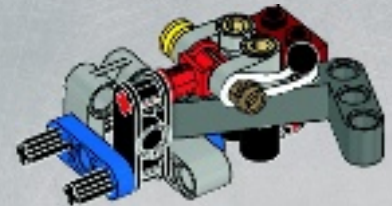

12

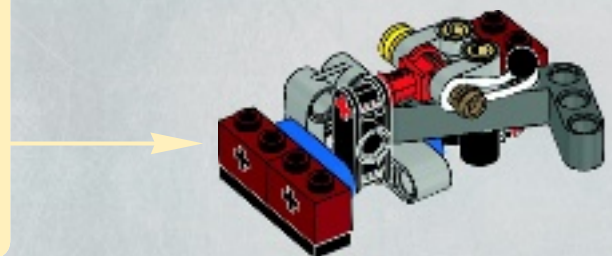
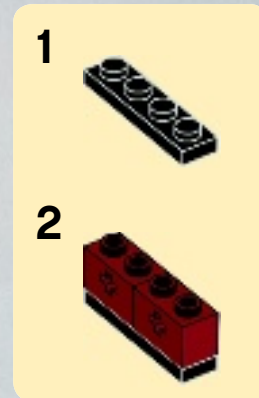

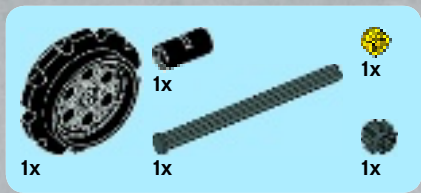

13

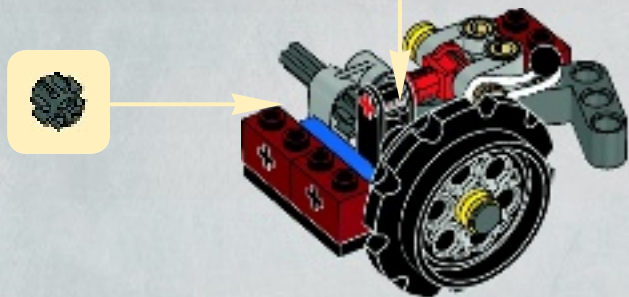
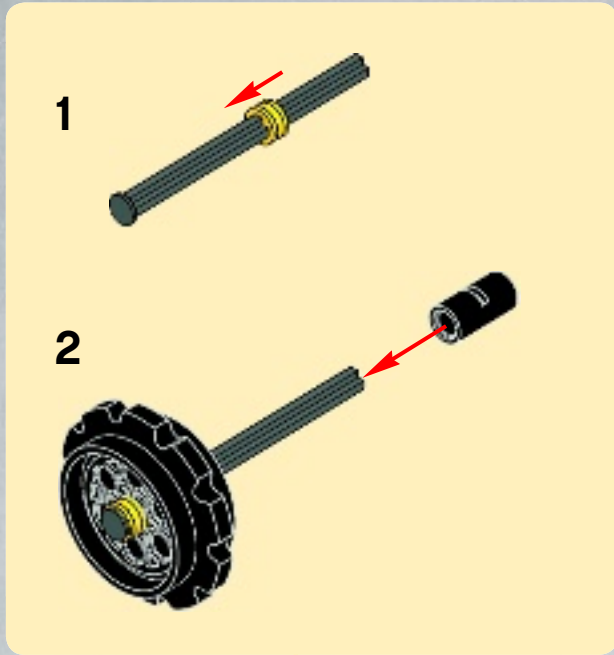

14

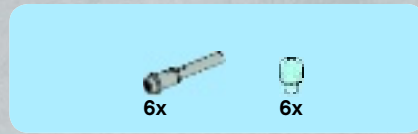
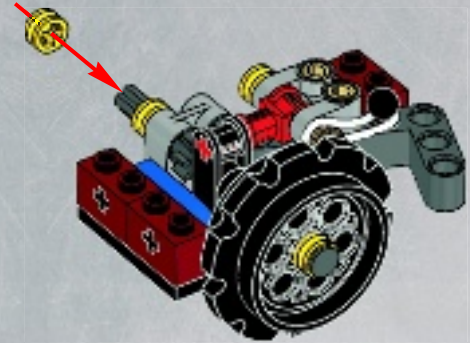

15

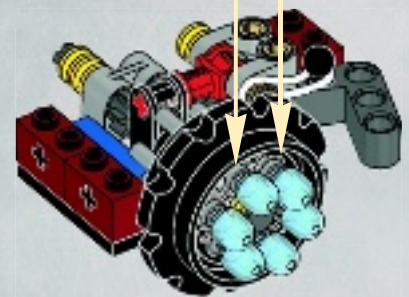
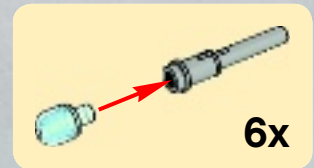

53

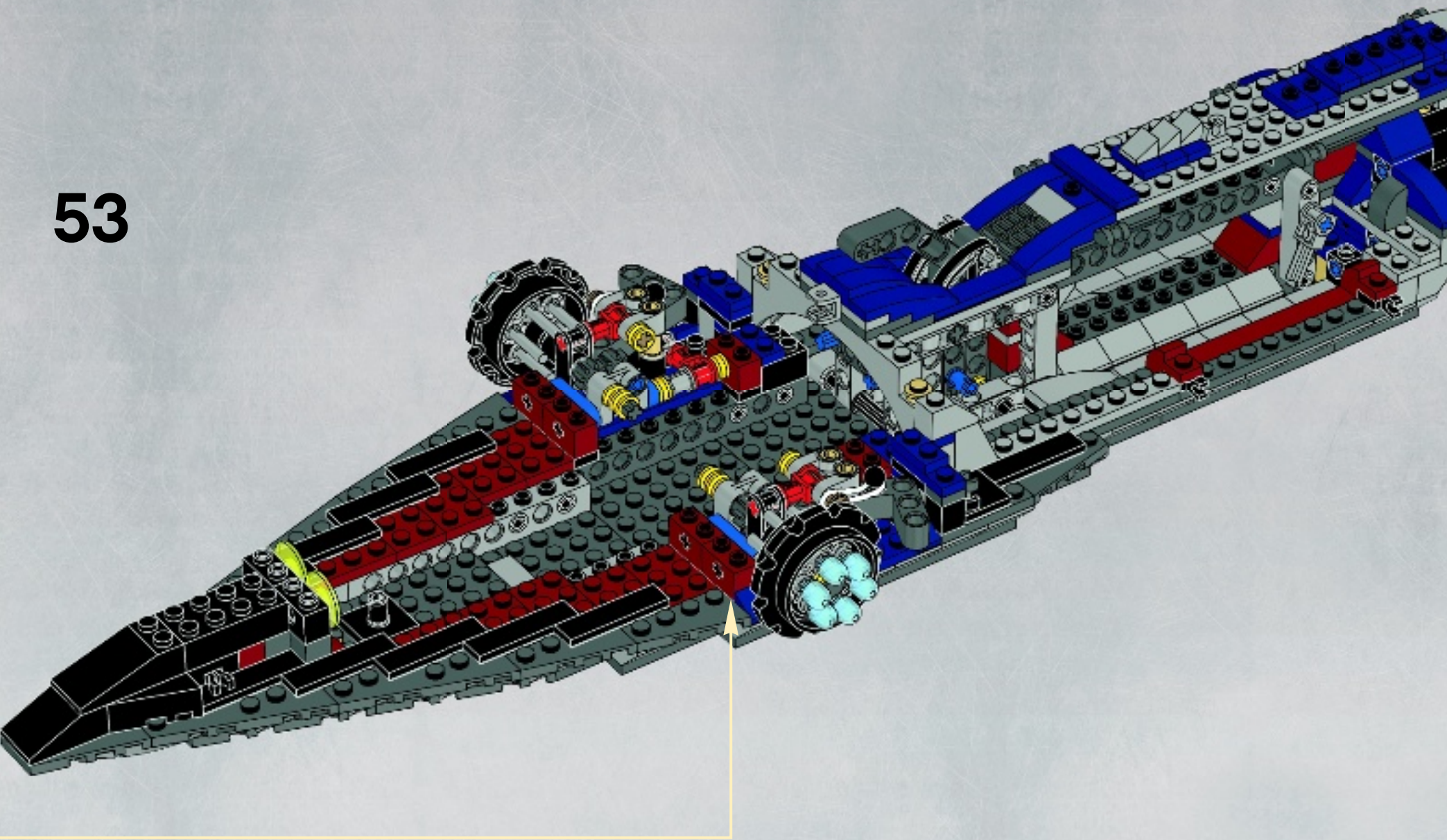



2x



2x

# 54

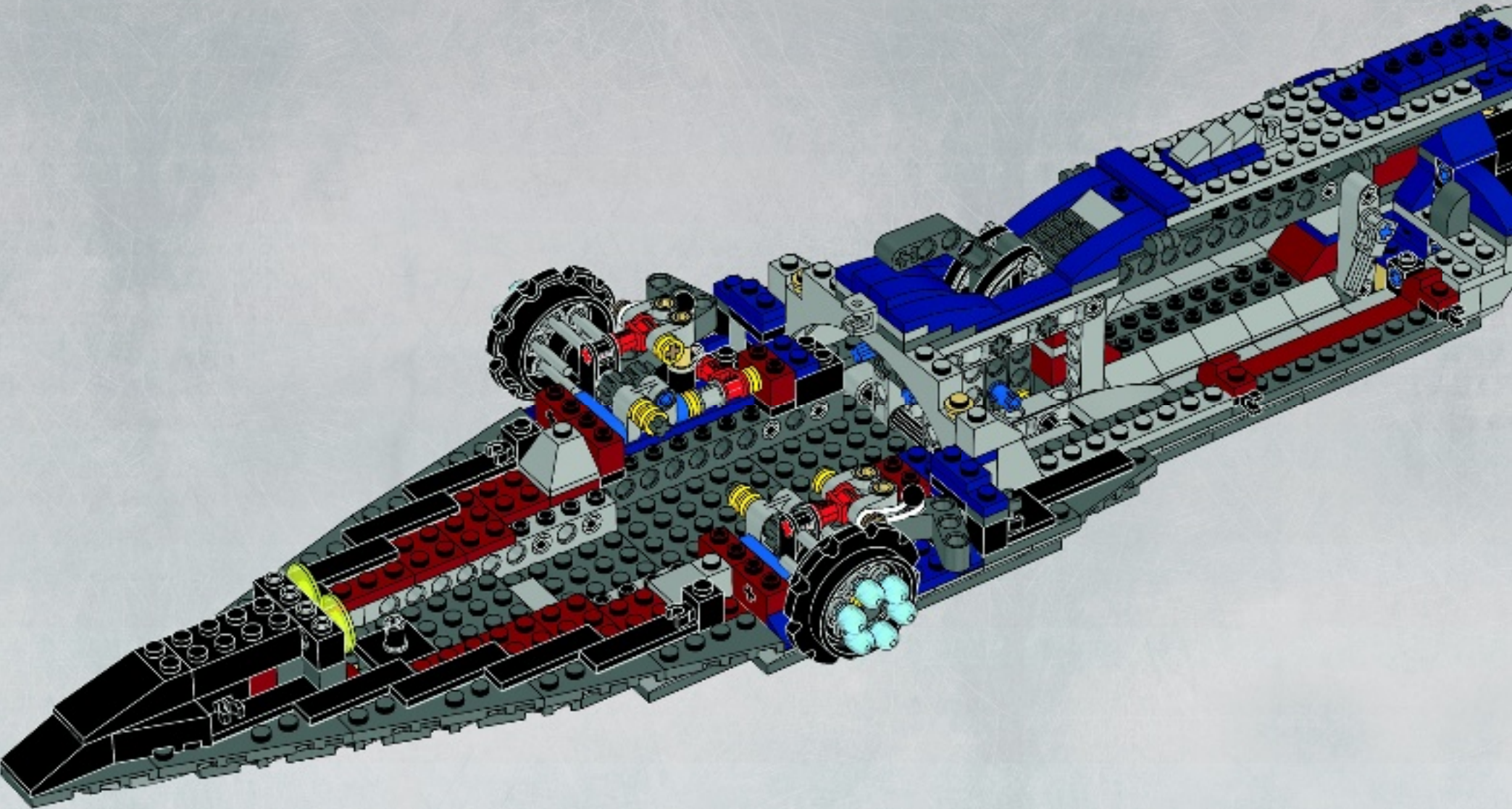



# 55

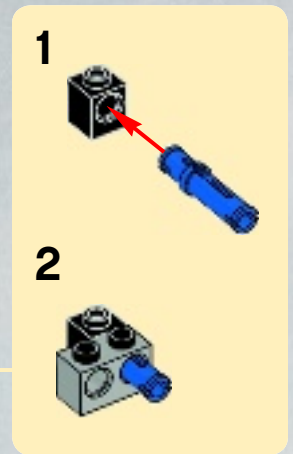
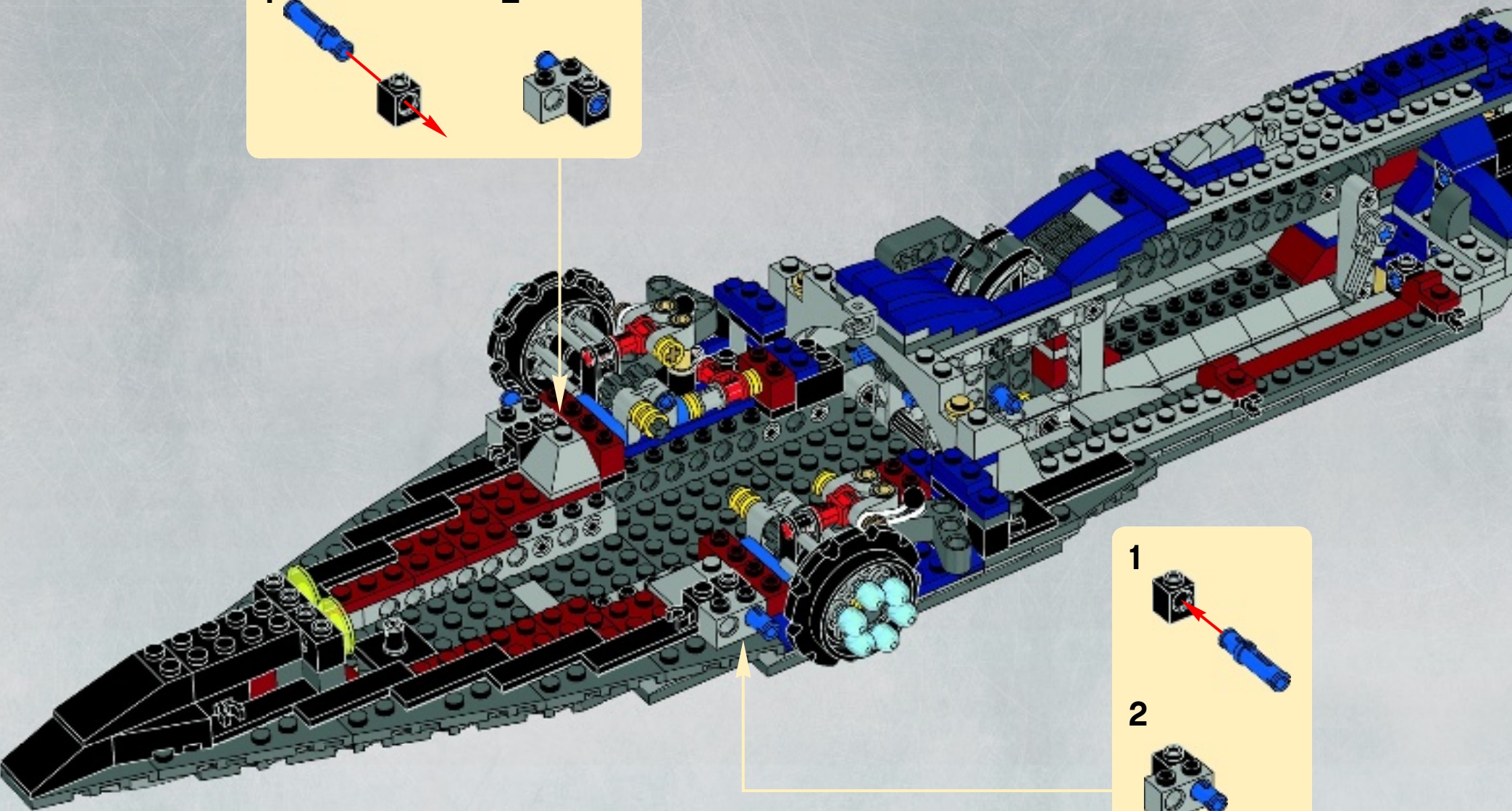
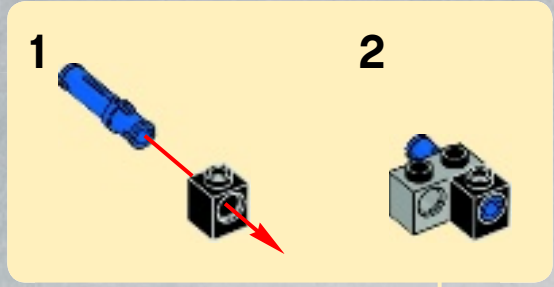



2x



2x



2x

# 56

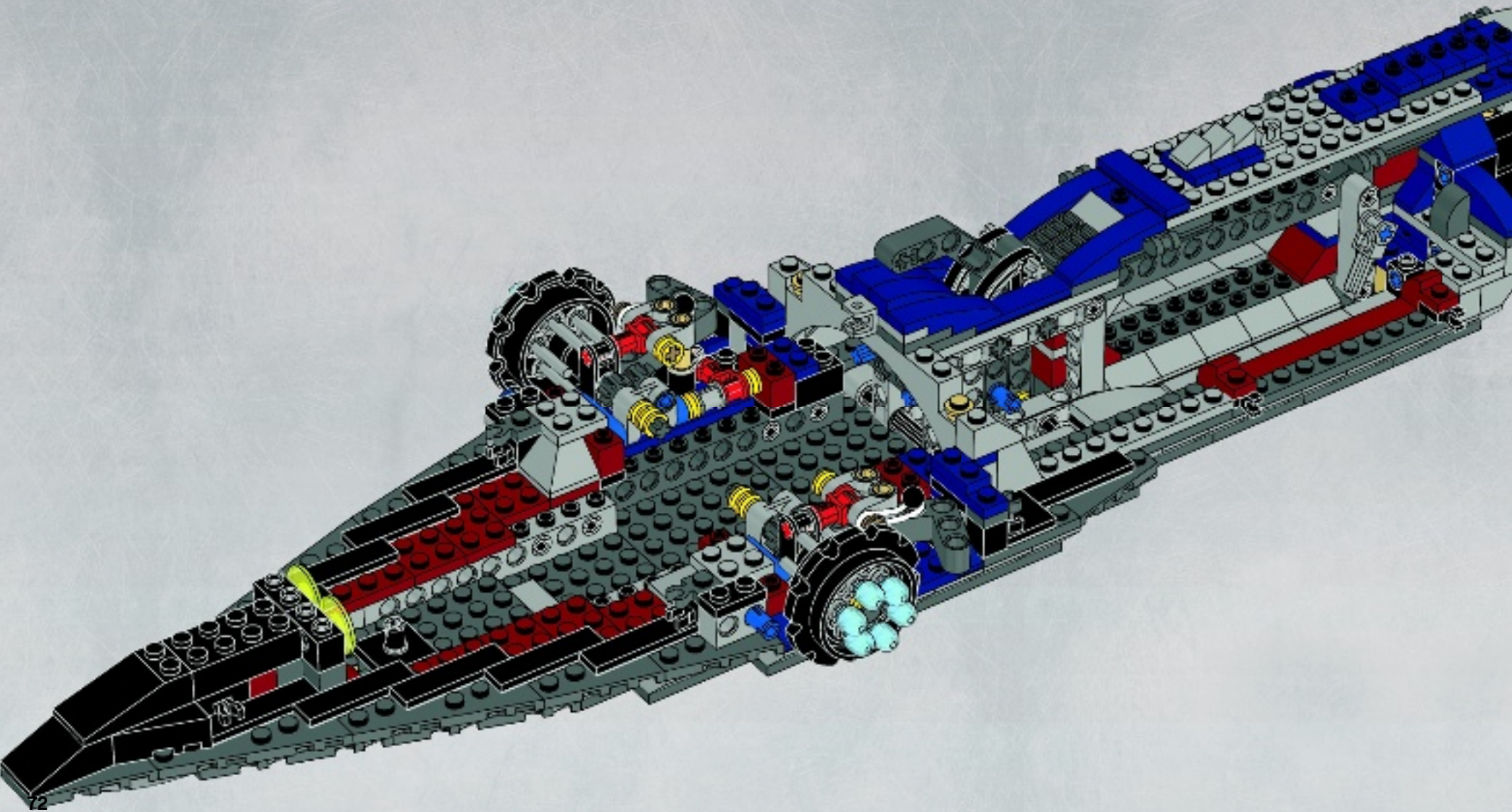





2x

57

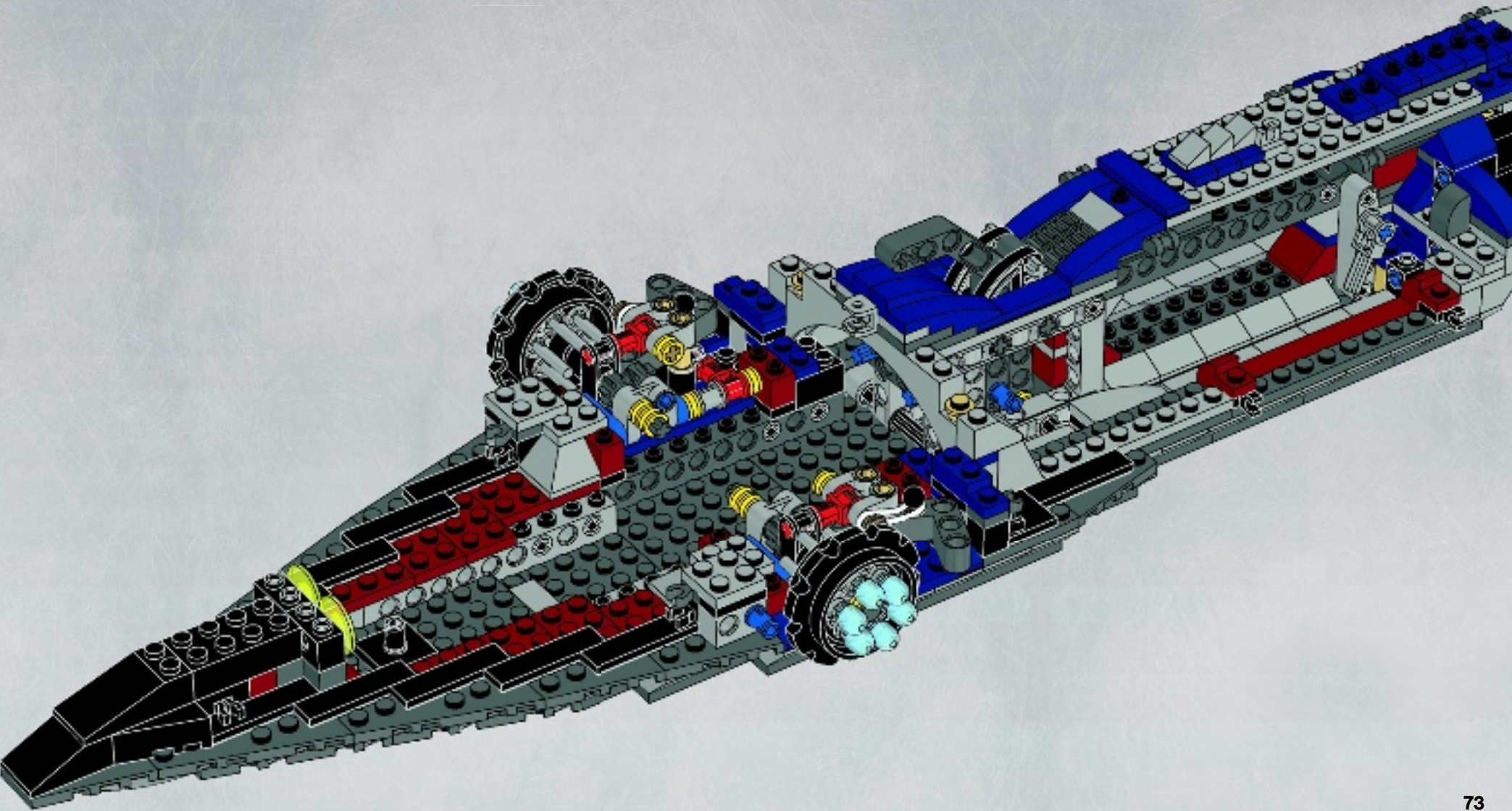



2x



2x

# 58

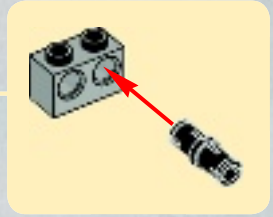
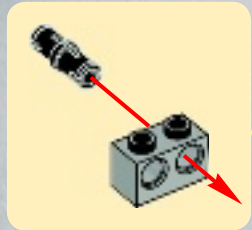
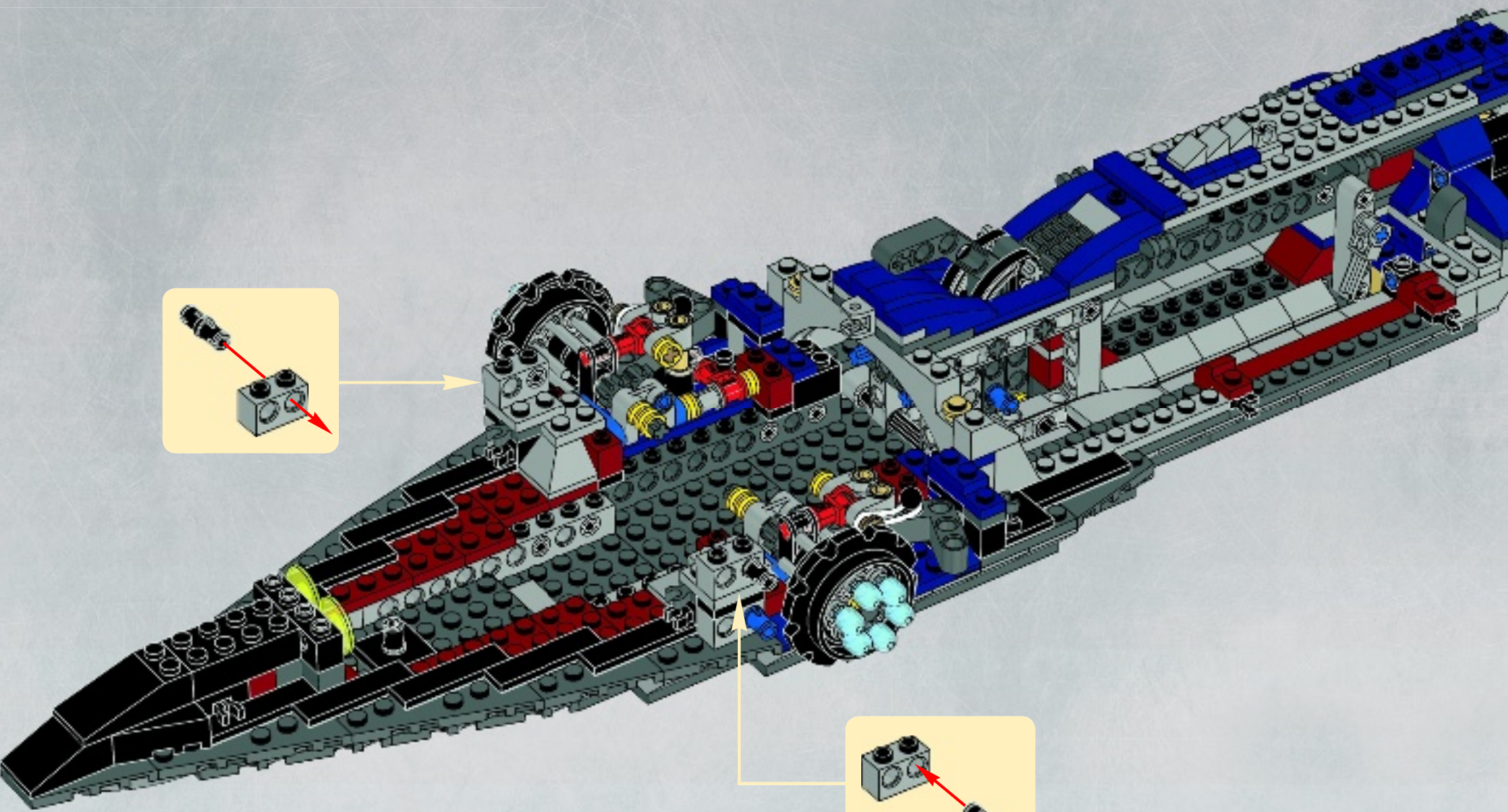



2x

# 59



2x

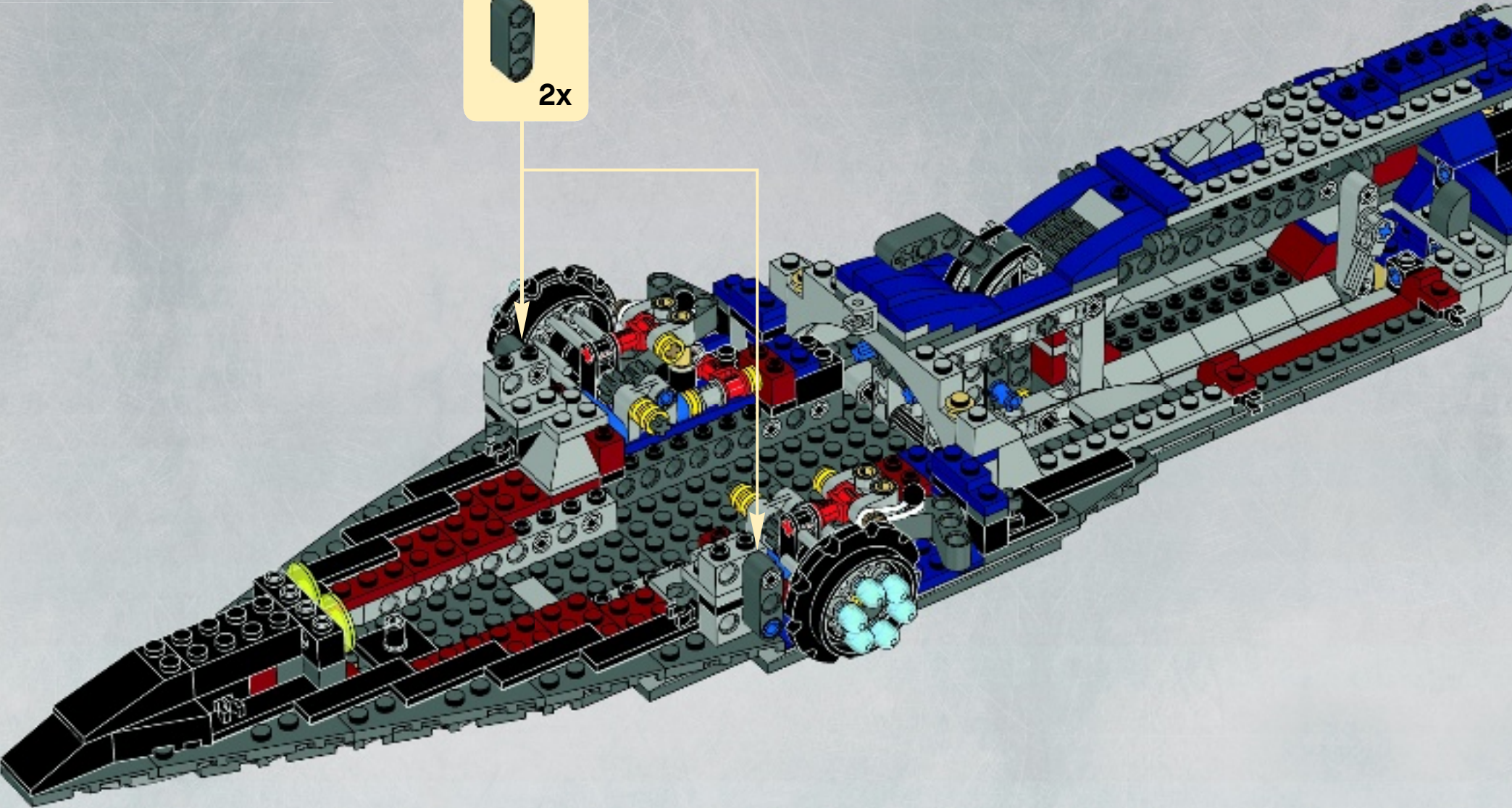



60

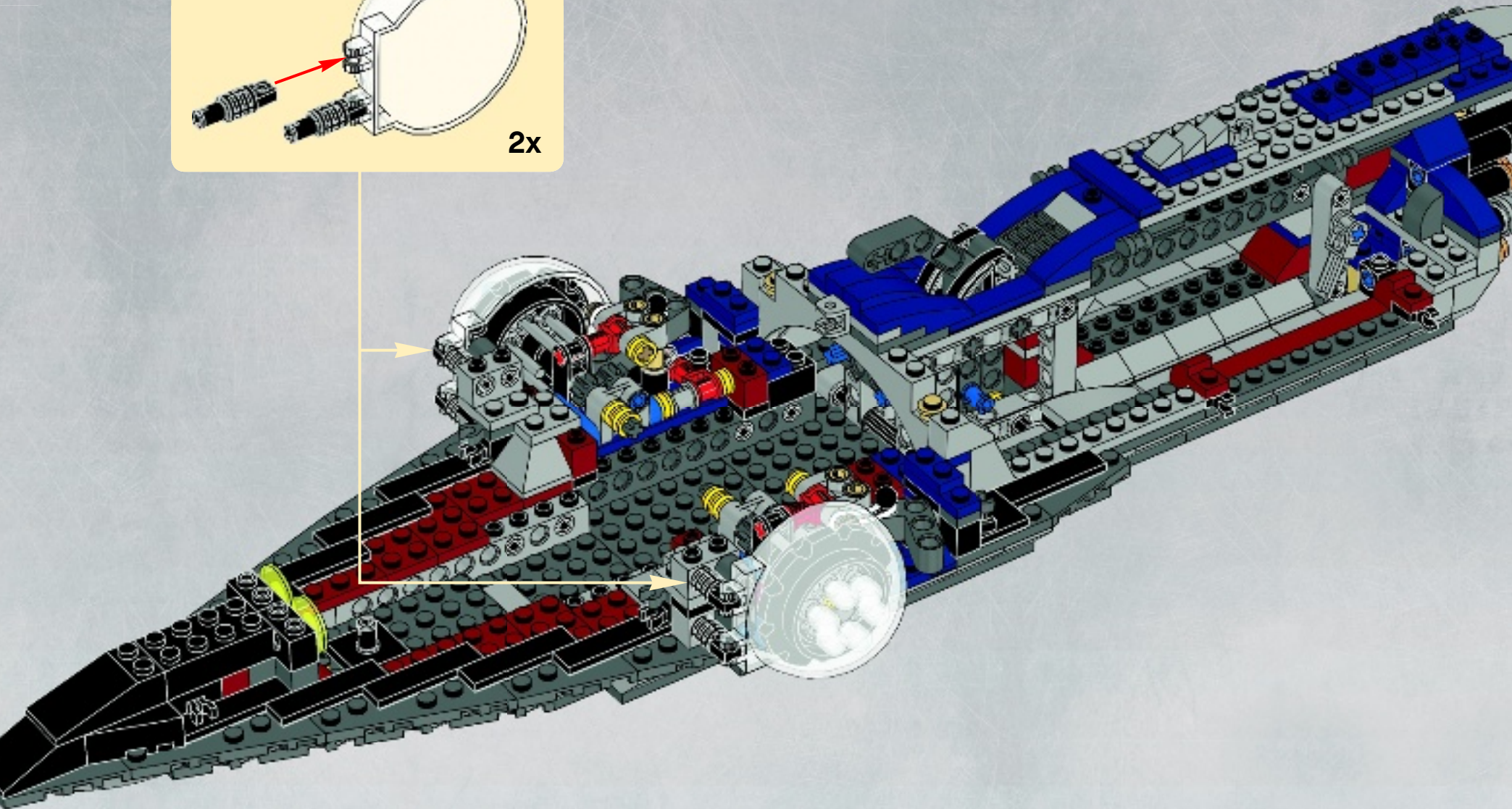
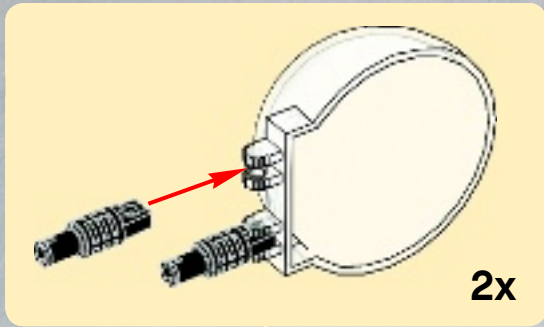

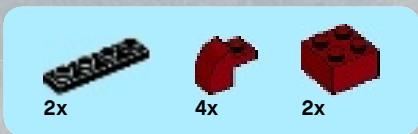
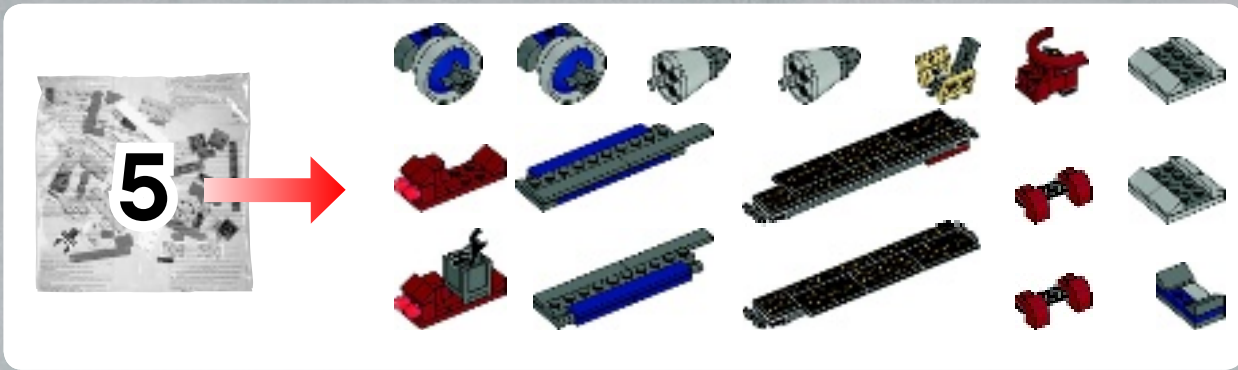

61

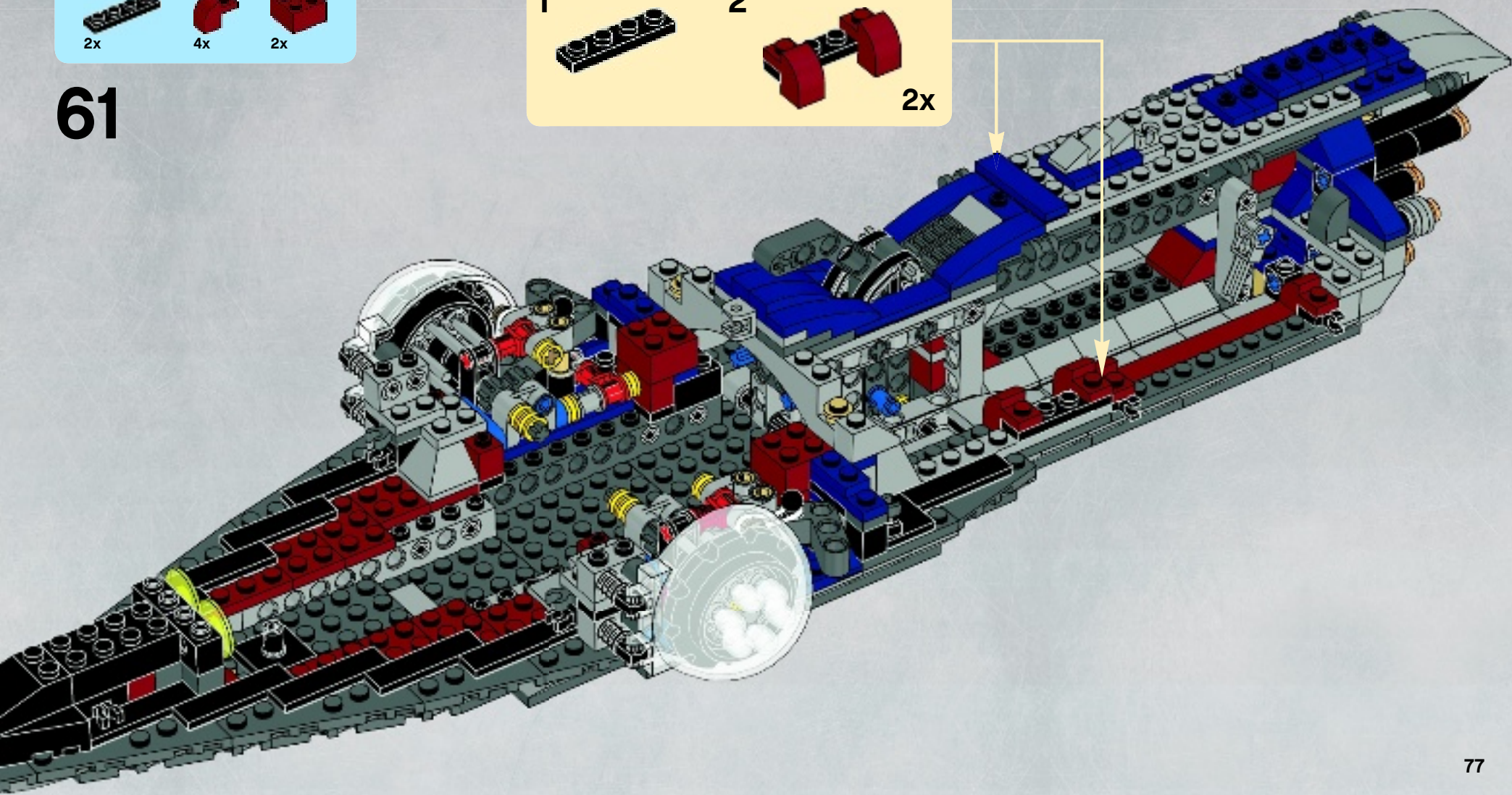

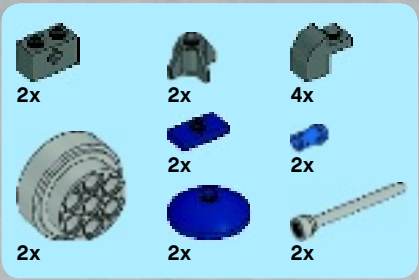

# 62

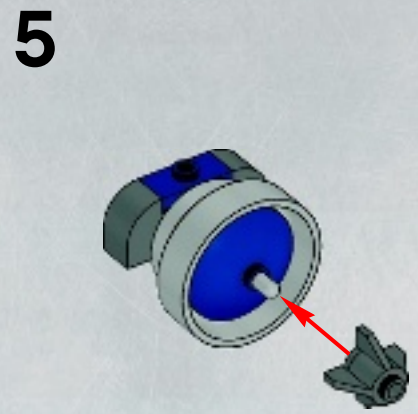
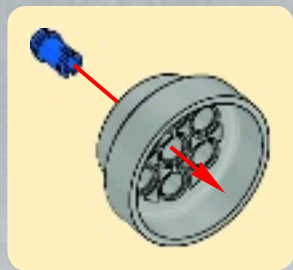
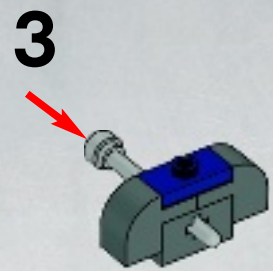

**2x**

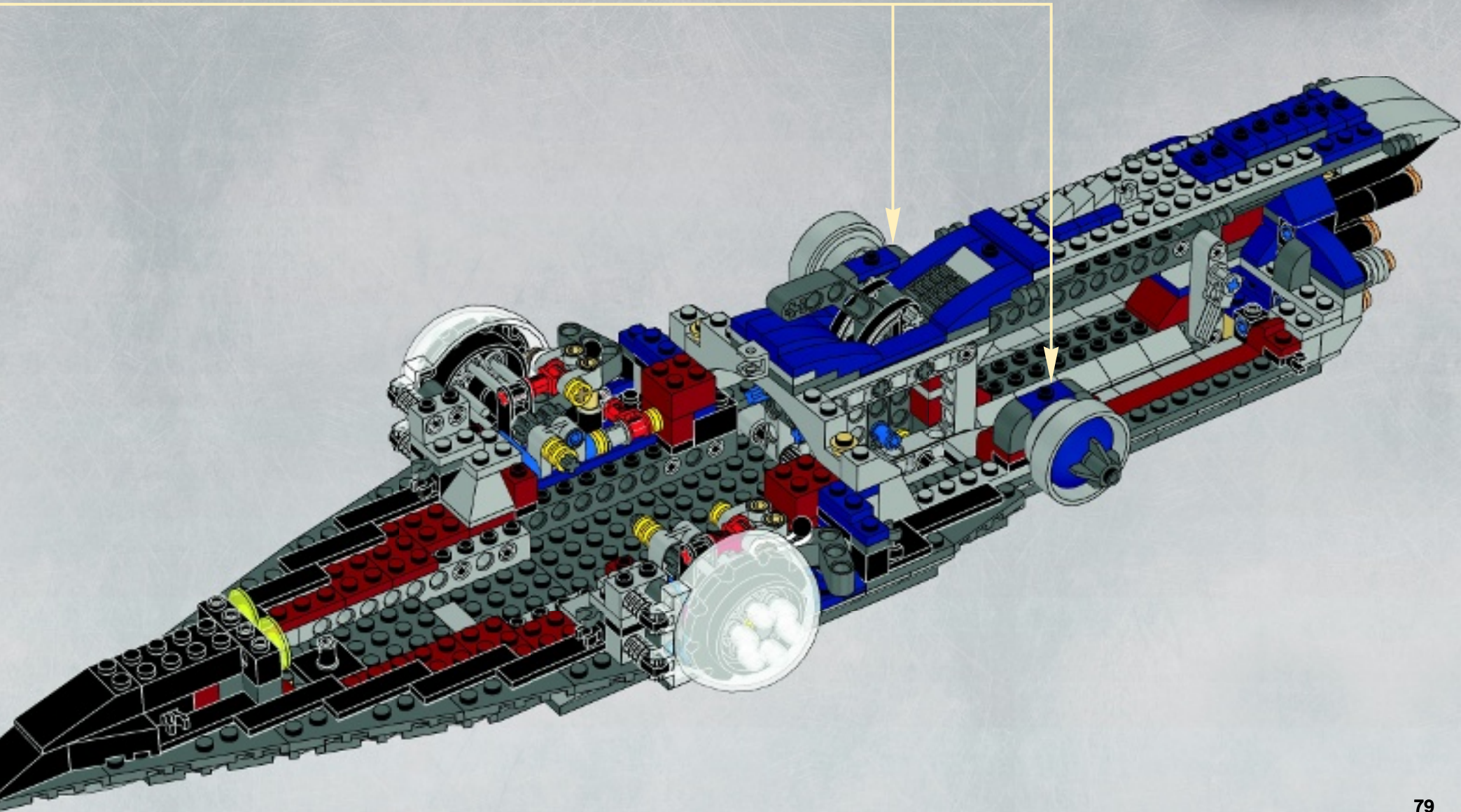



2x





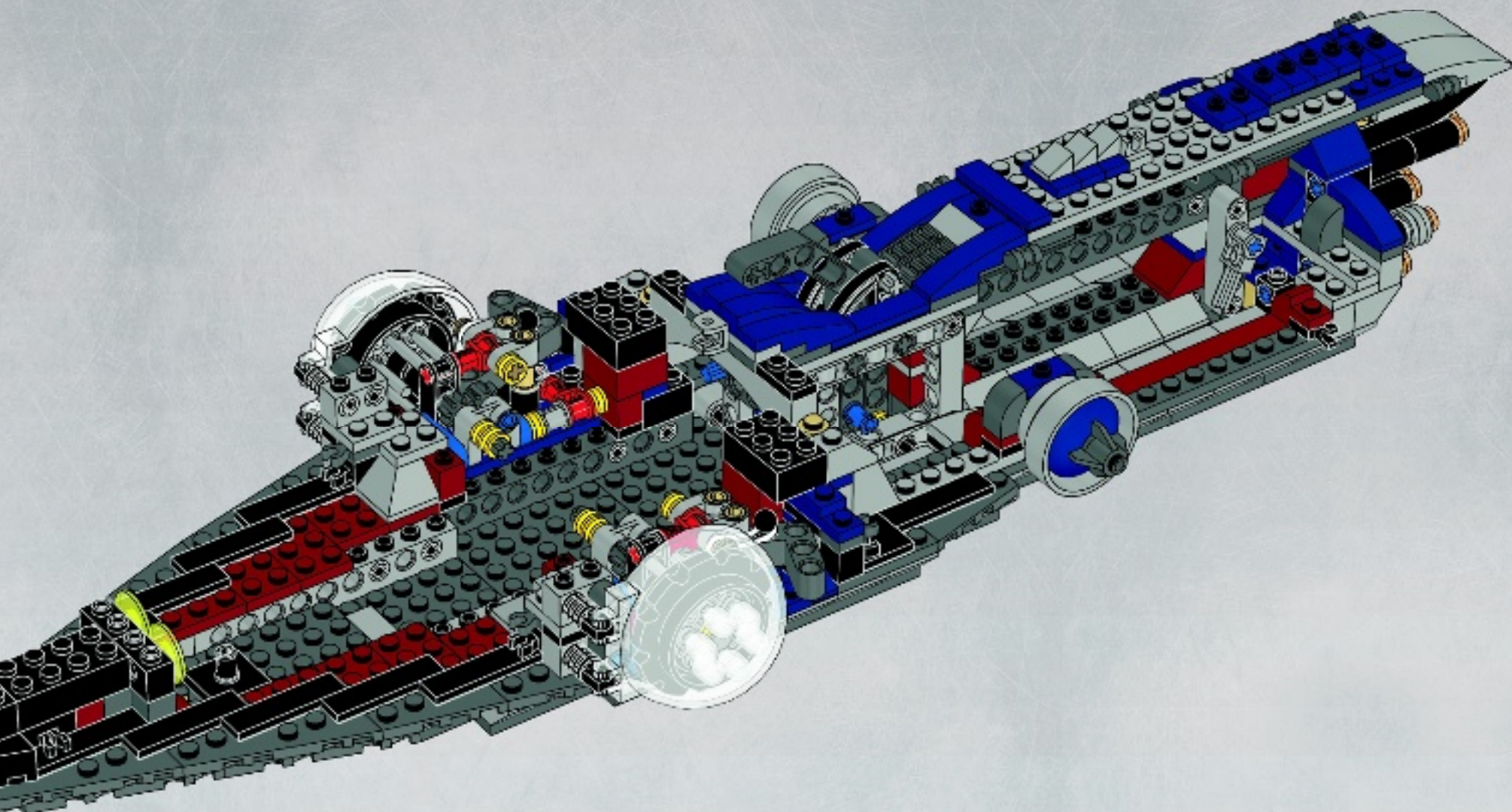

2x

# 63





 2x	 2x
 2x	 2x

# 64

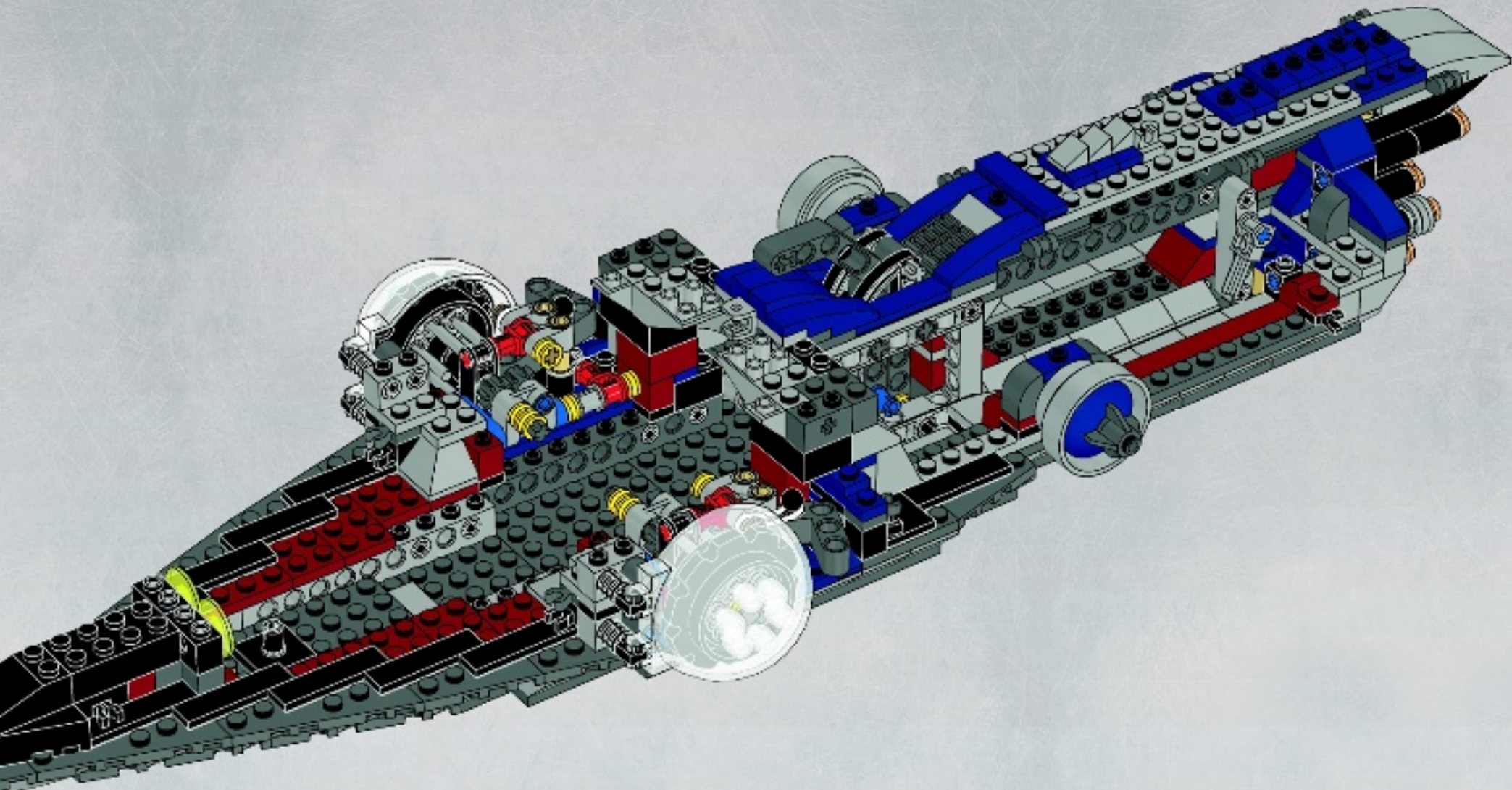

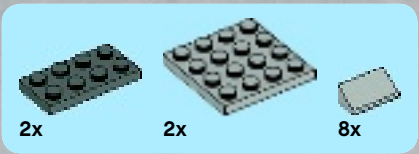

# 65

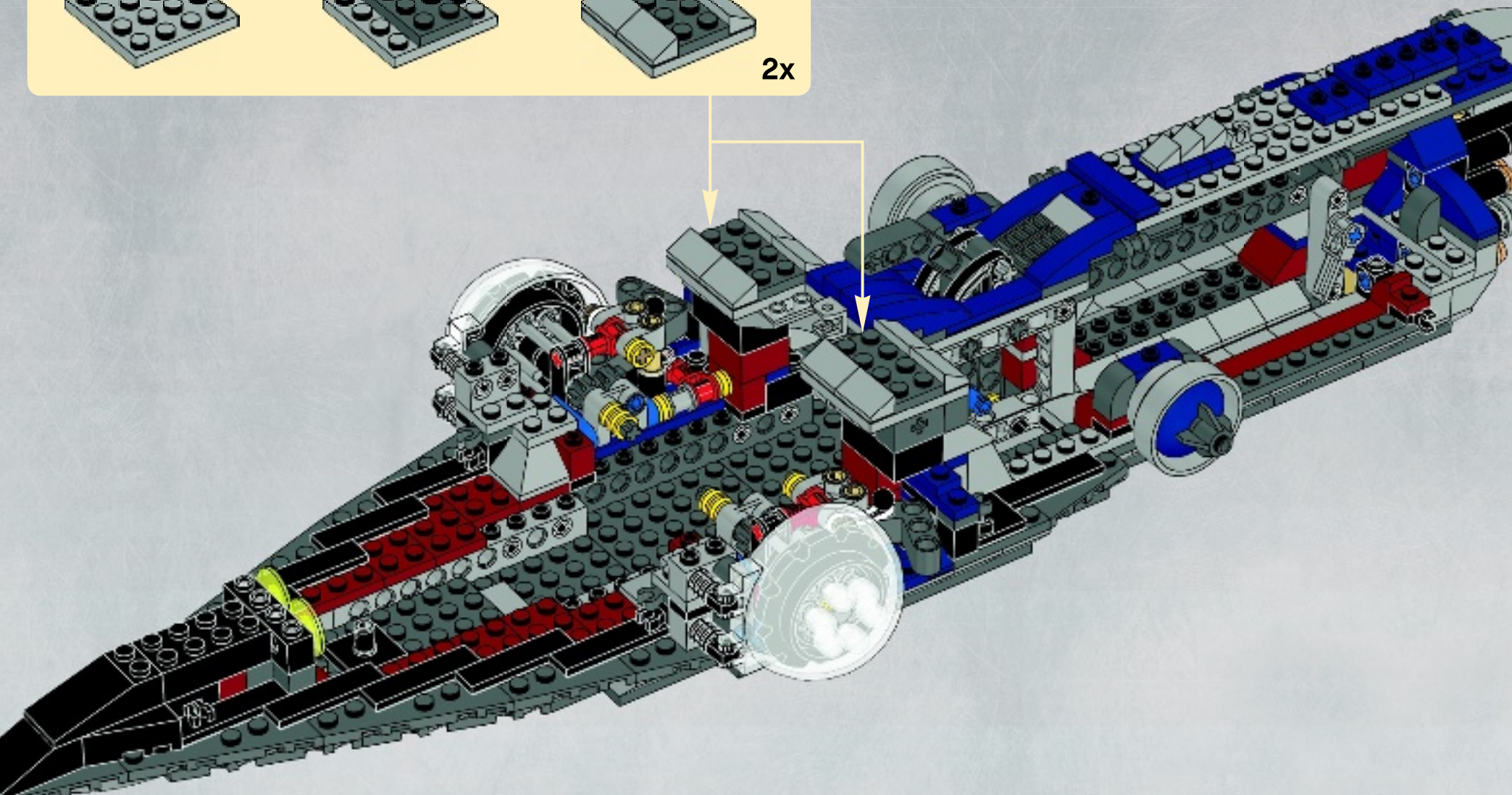

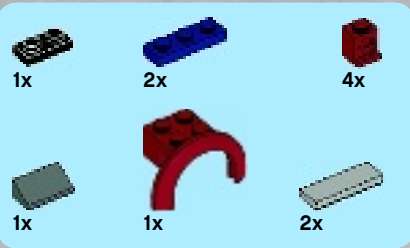

66

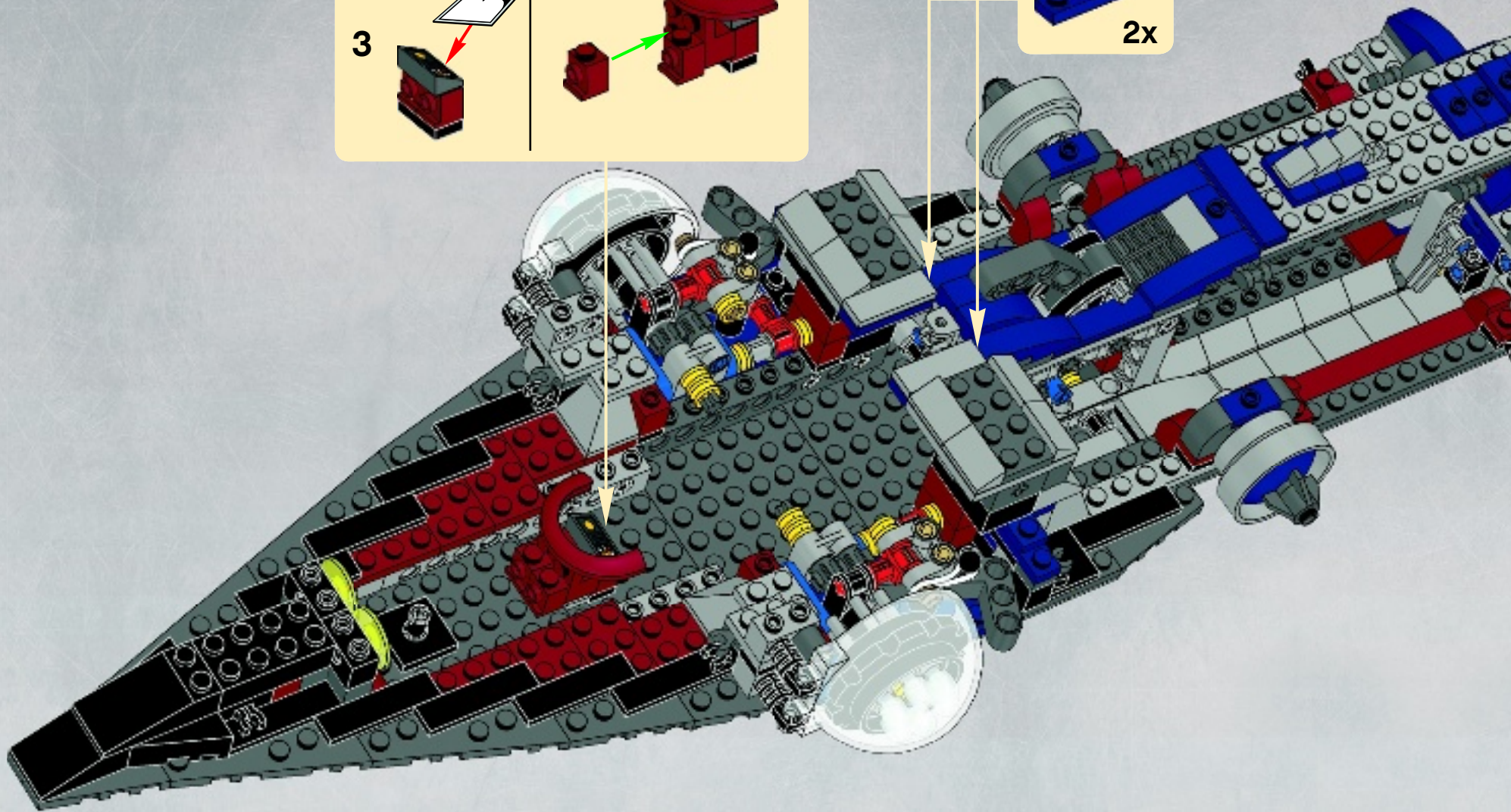
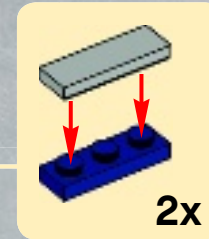
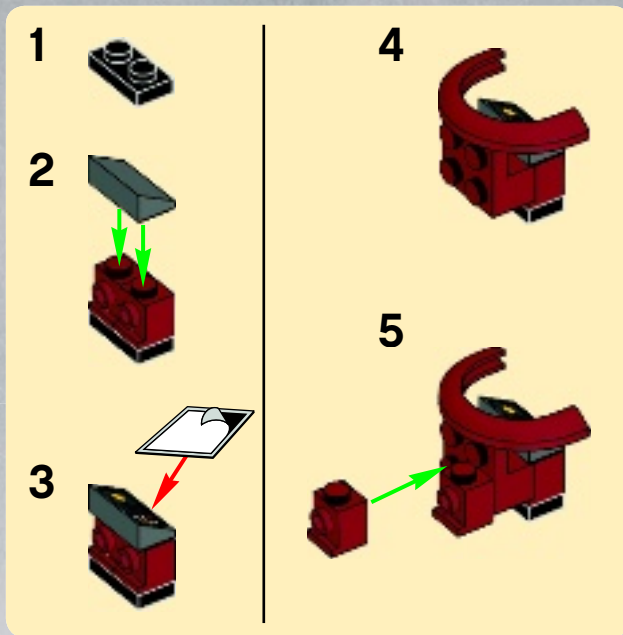

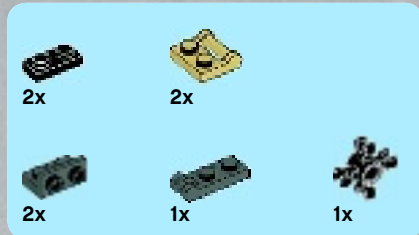

# 67

