

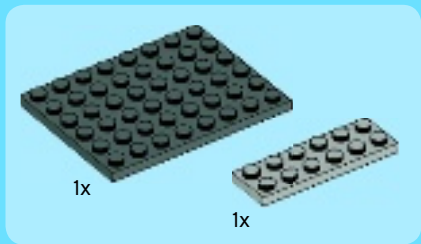

10226

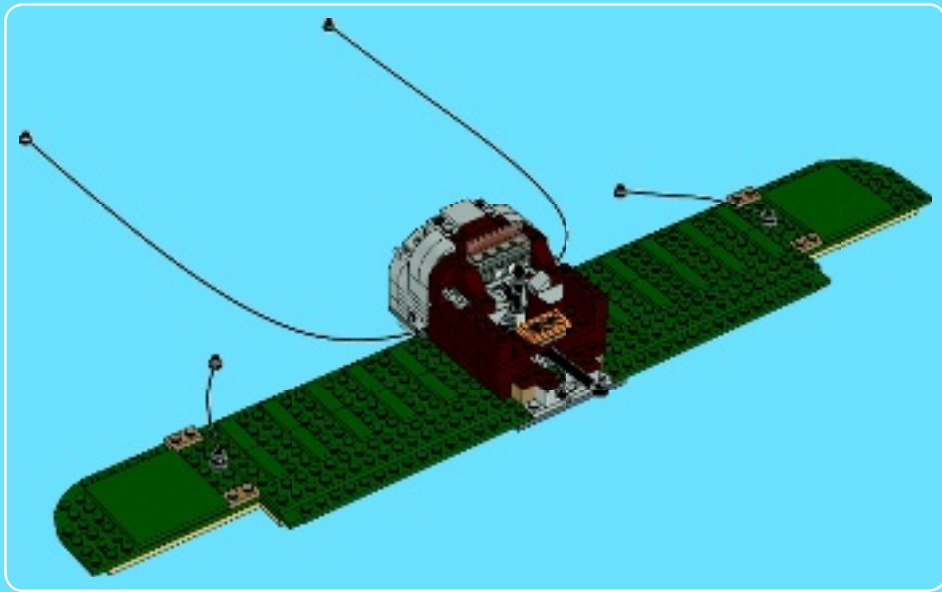



1

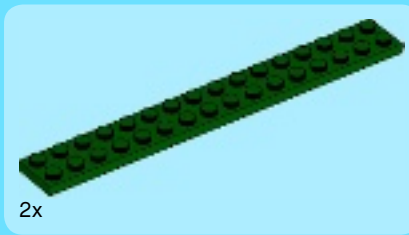

2

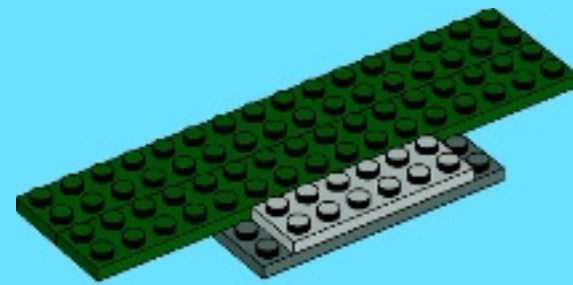

<http://lego.com/brickseparator>

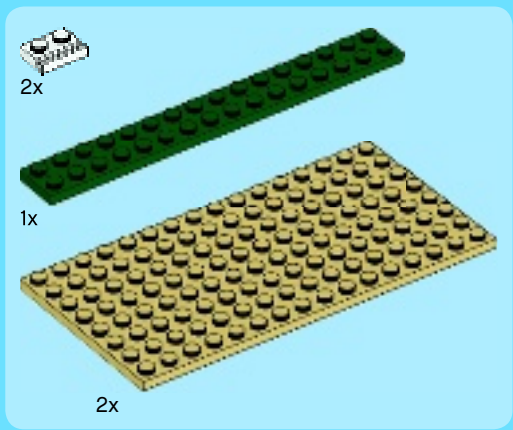

3

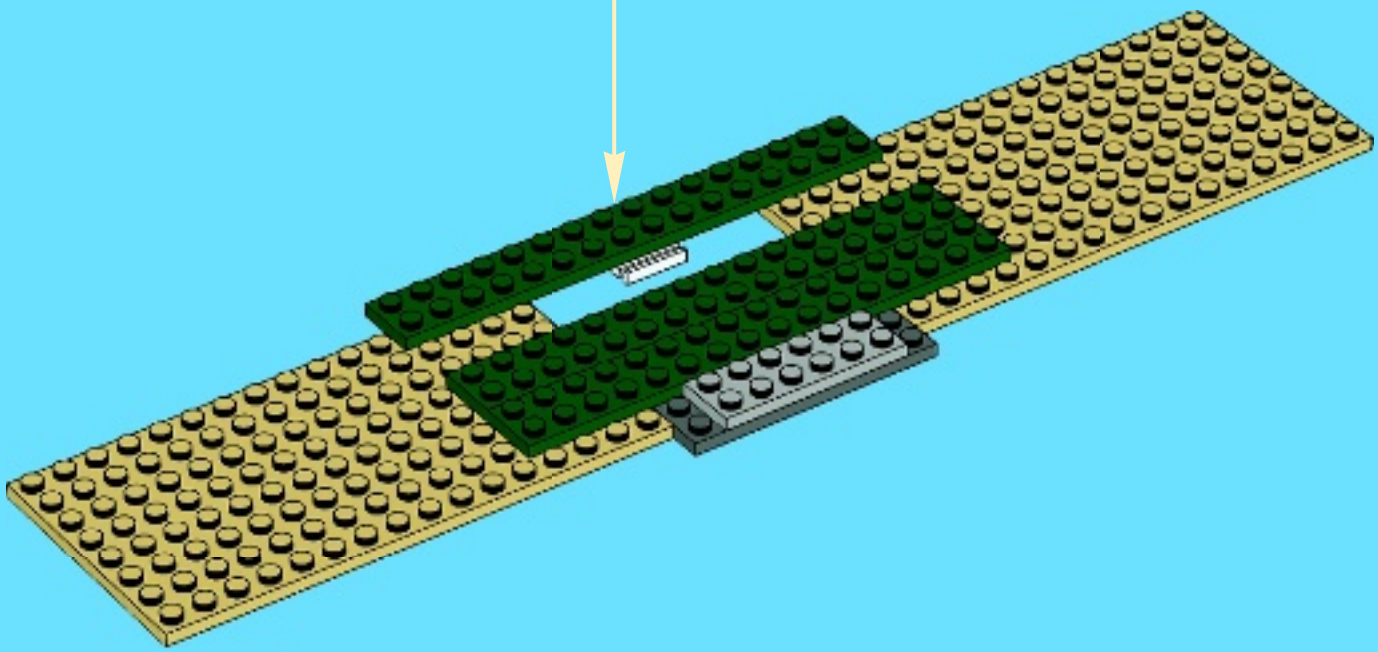
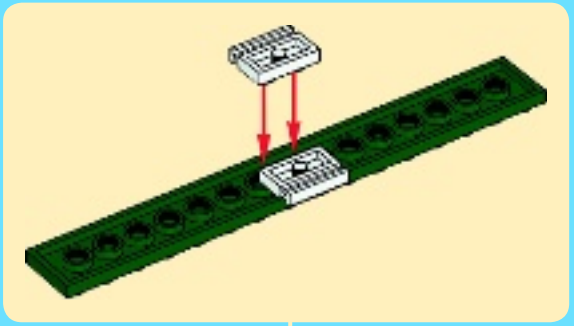

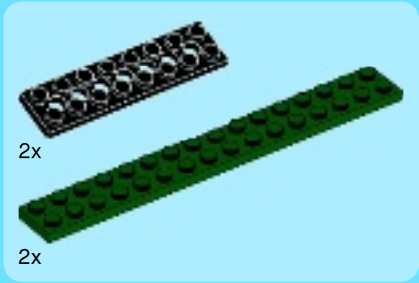

4

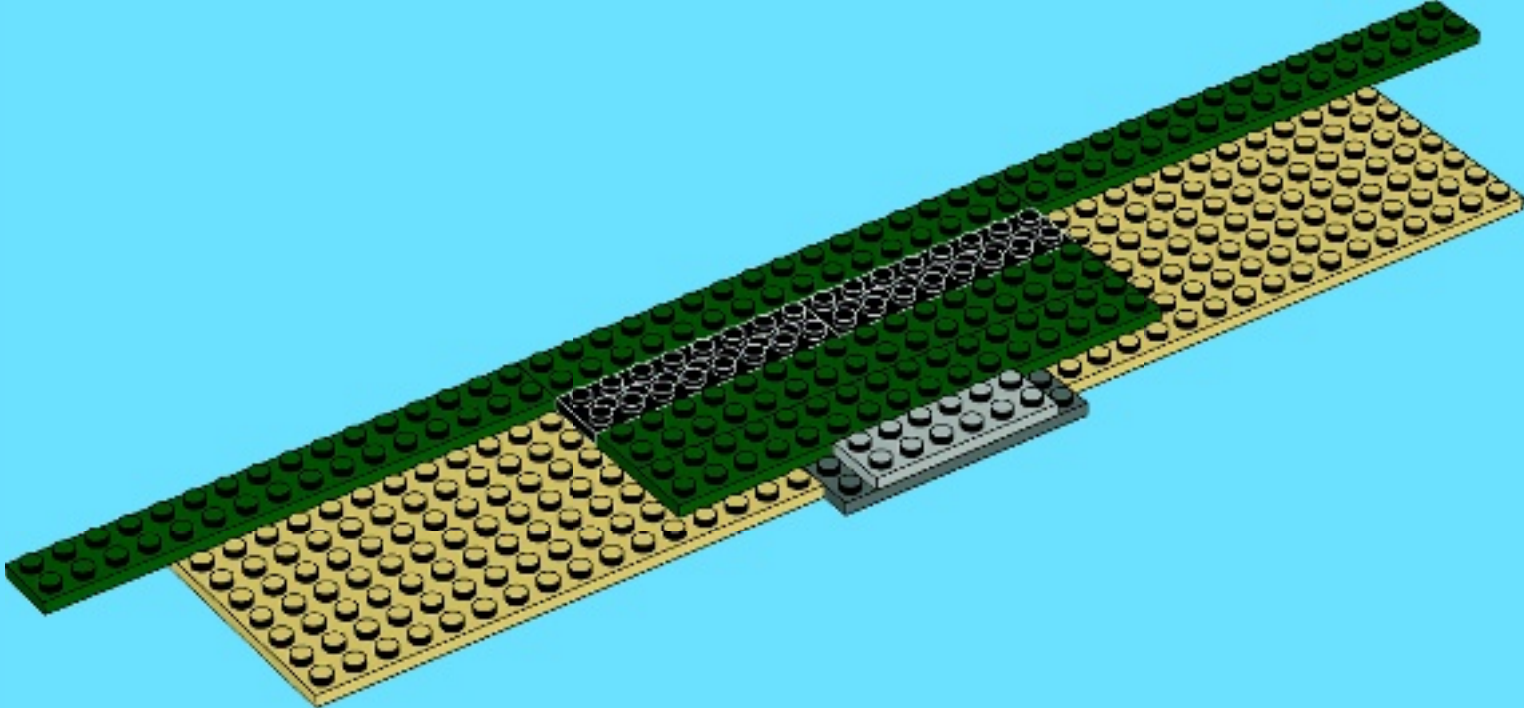





4x



6x



2x



2x

6

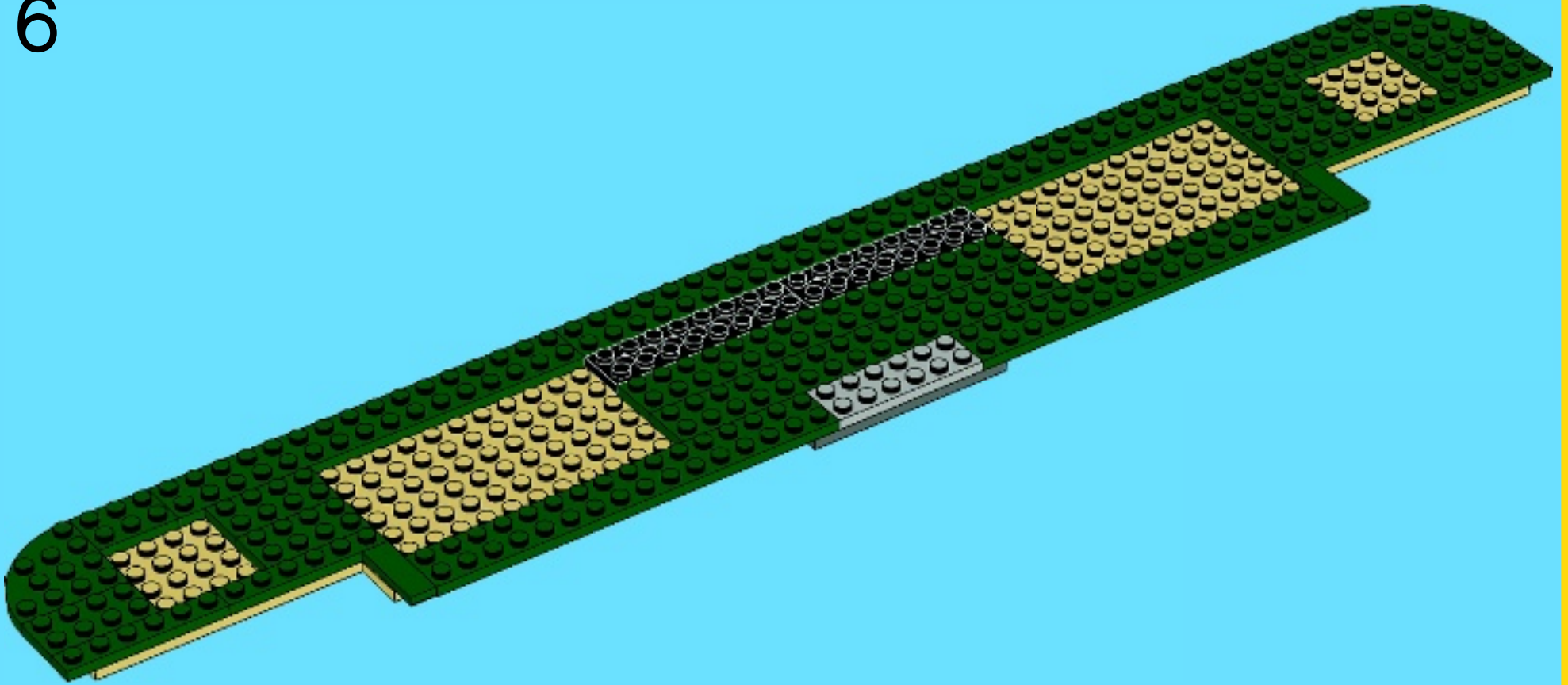

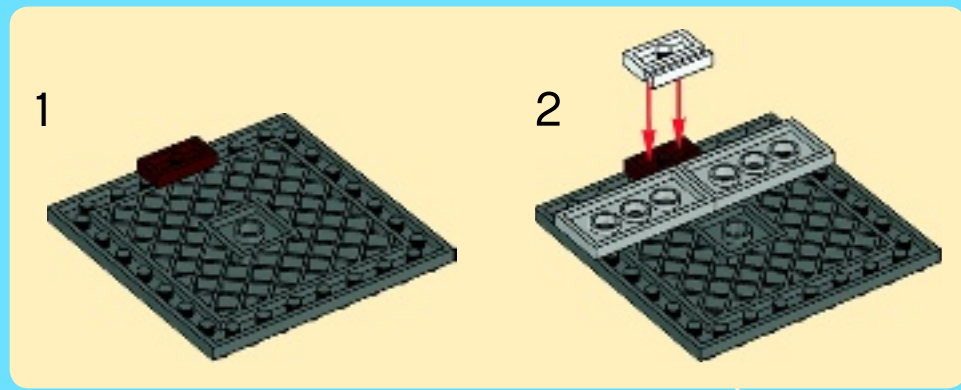
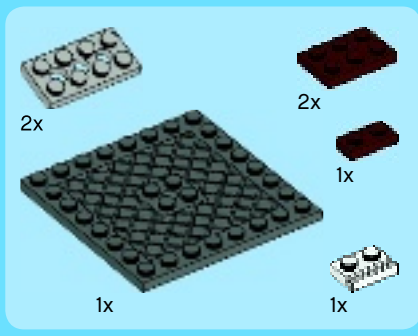

7

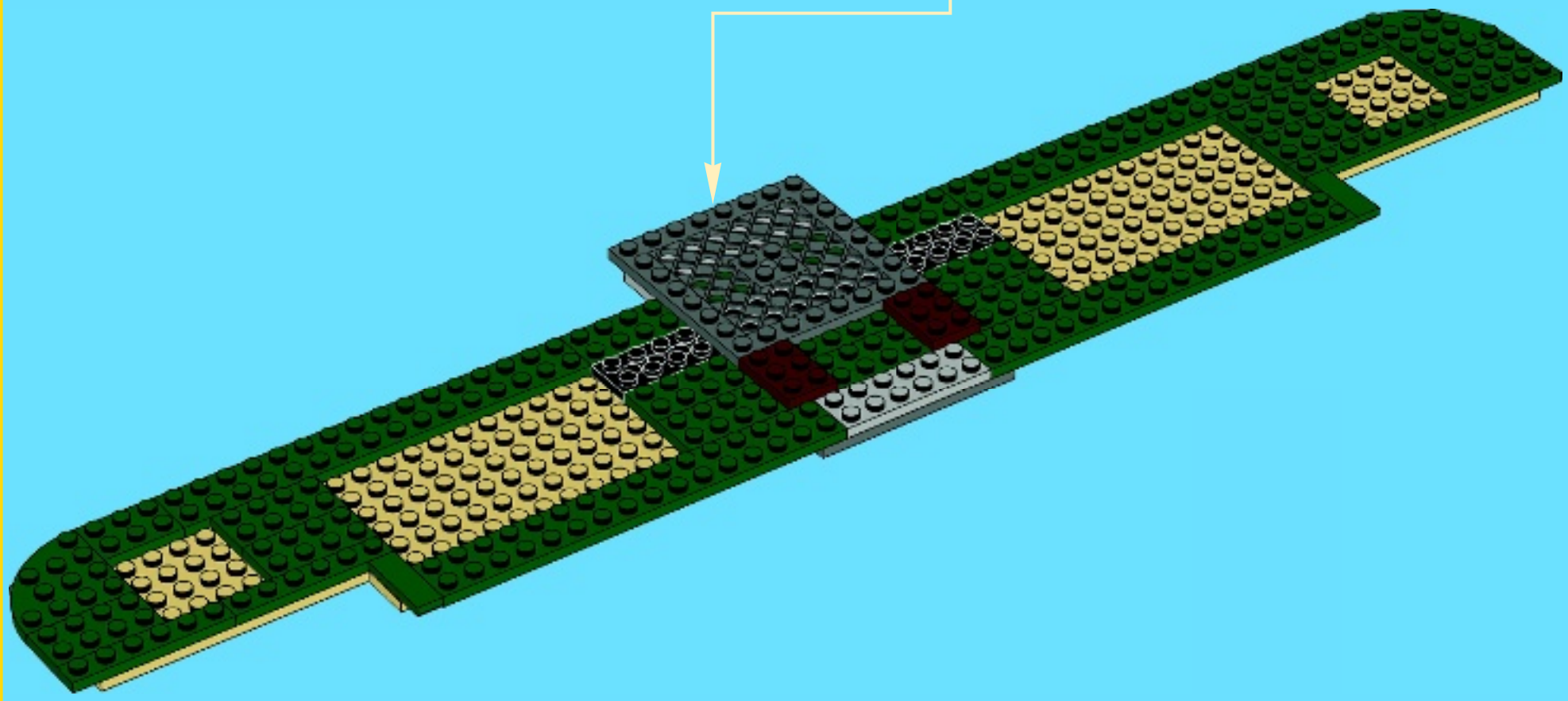

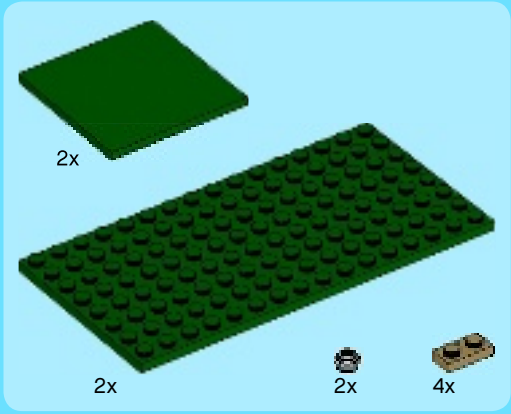

8

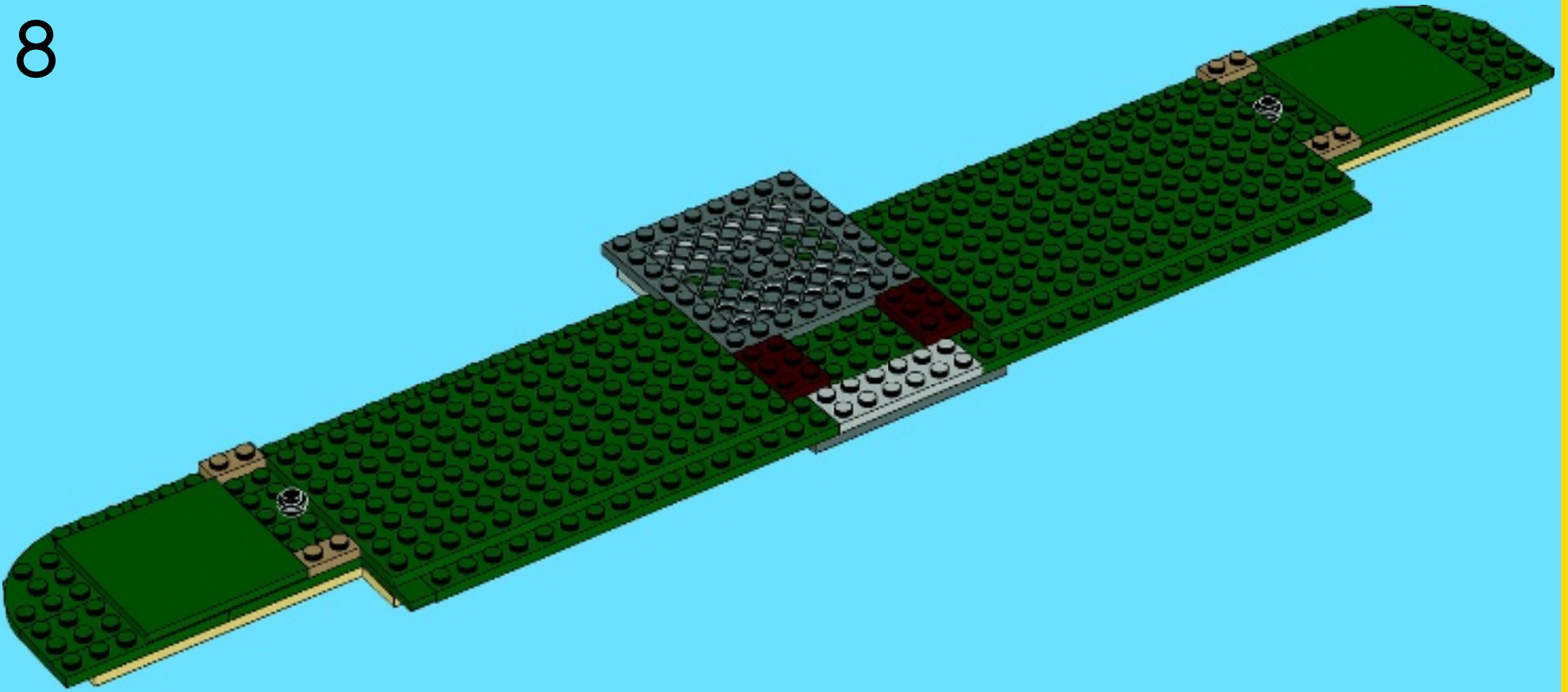



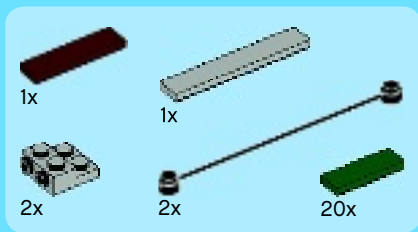

9

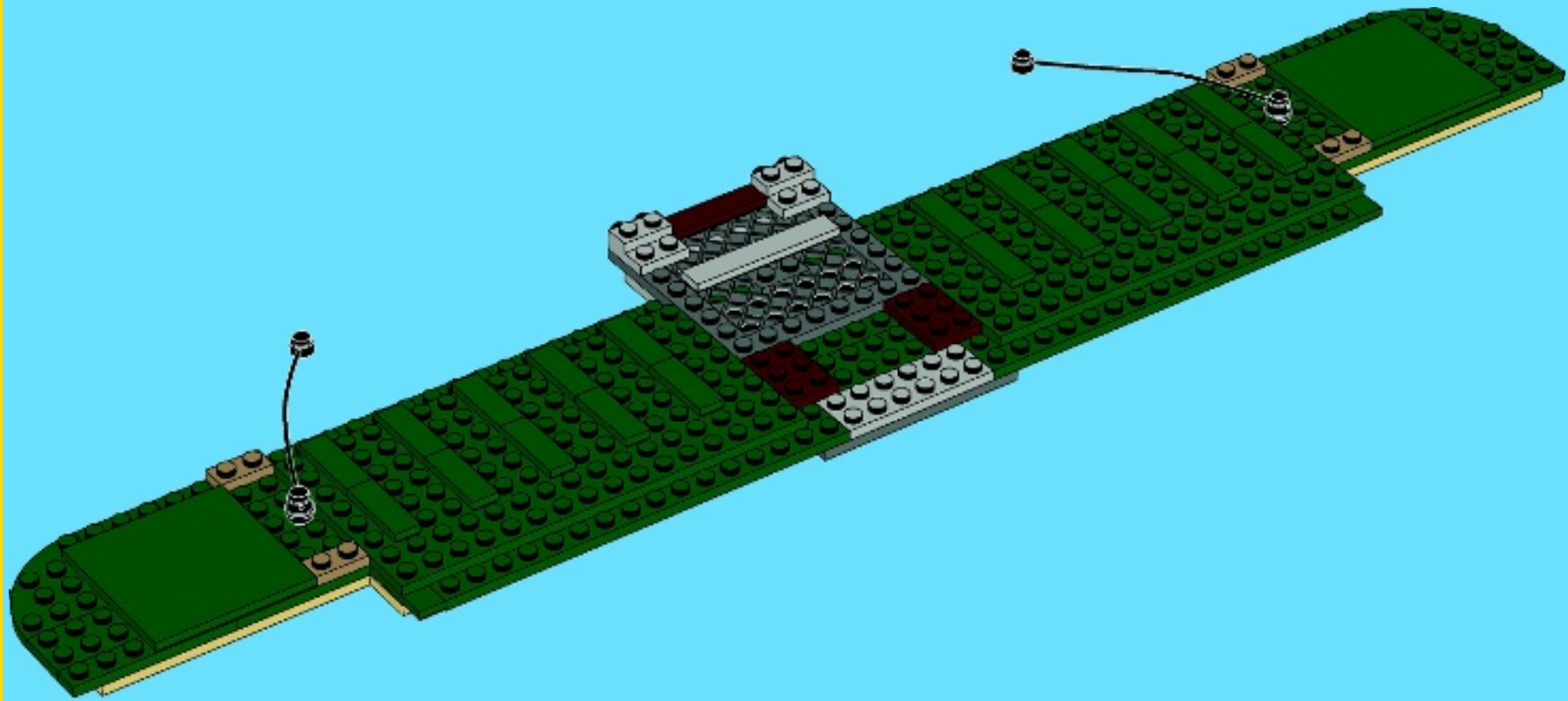



2x



1x

# 10



2x

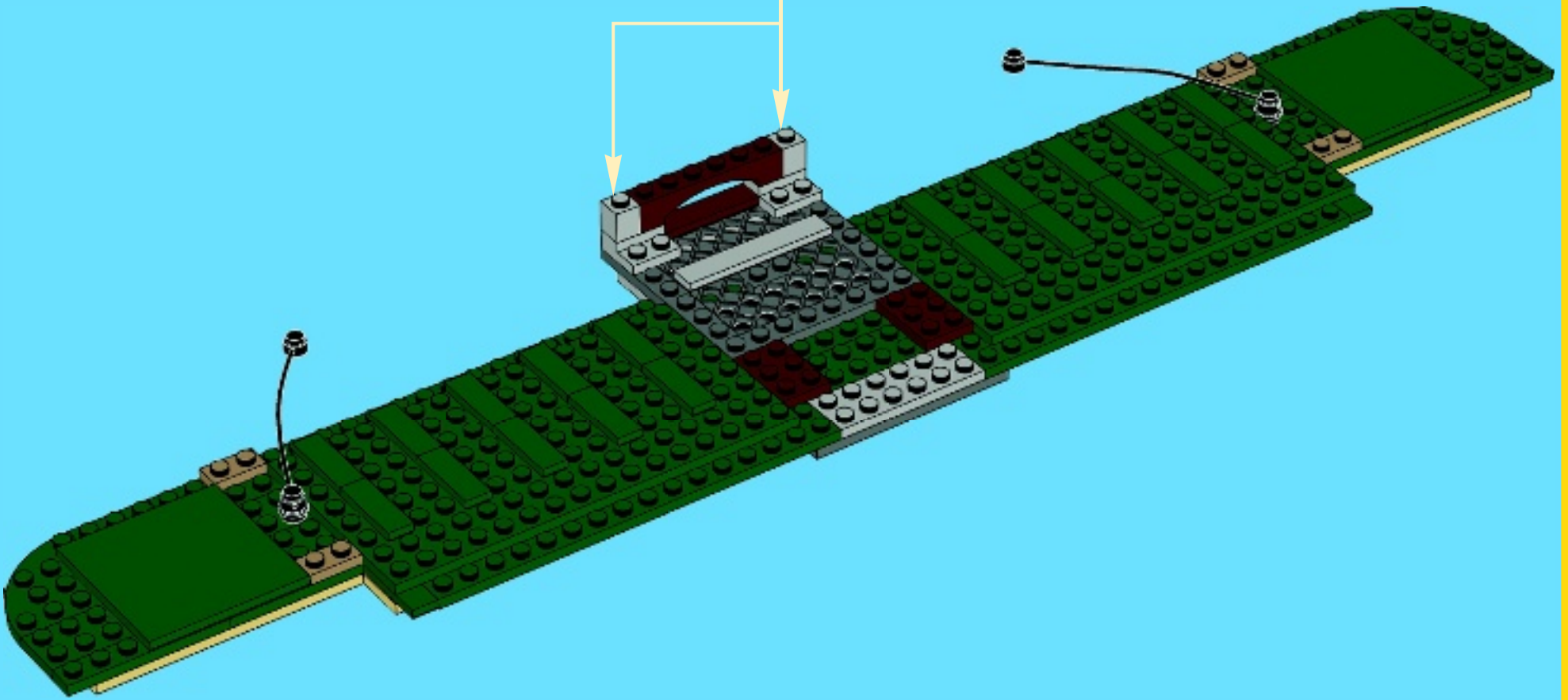

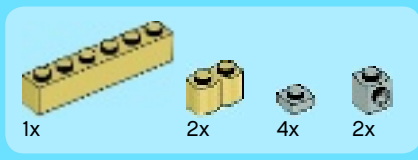

11

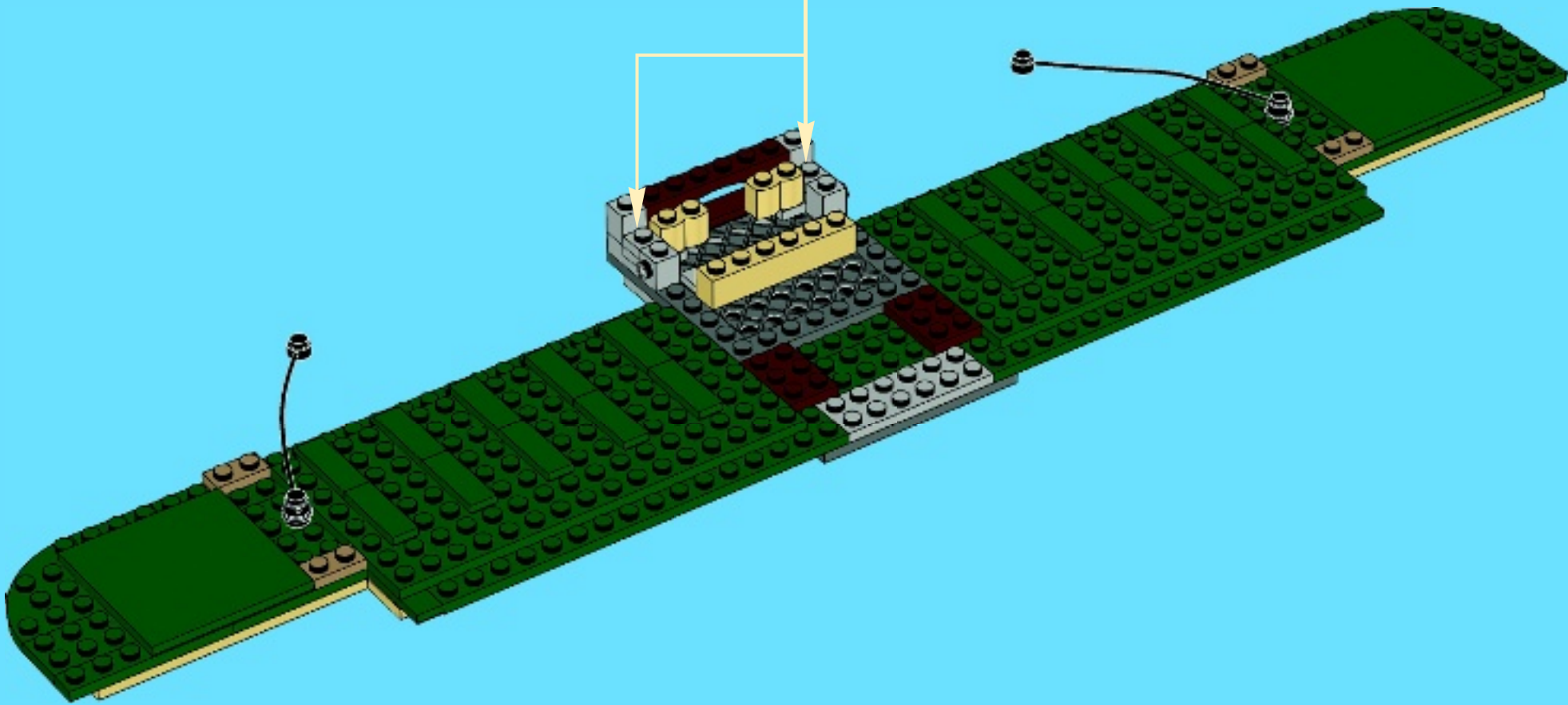
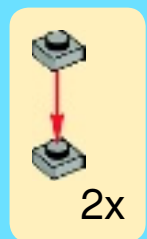

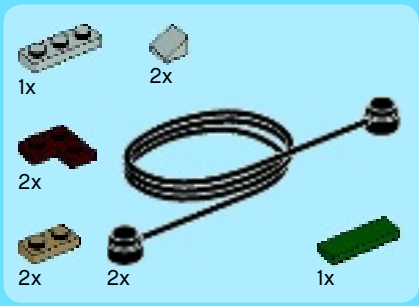

# 12

1



2

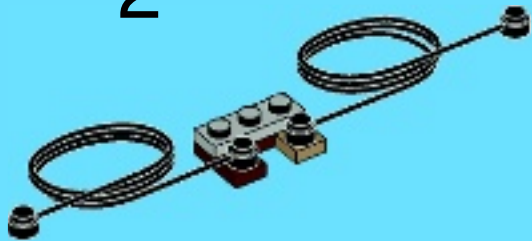

3

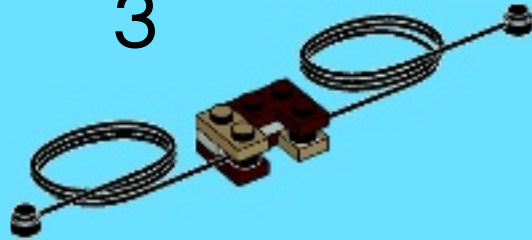

4

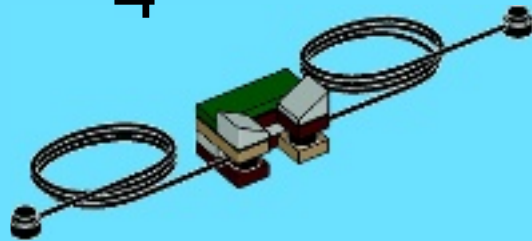





13

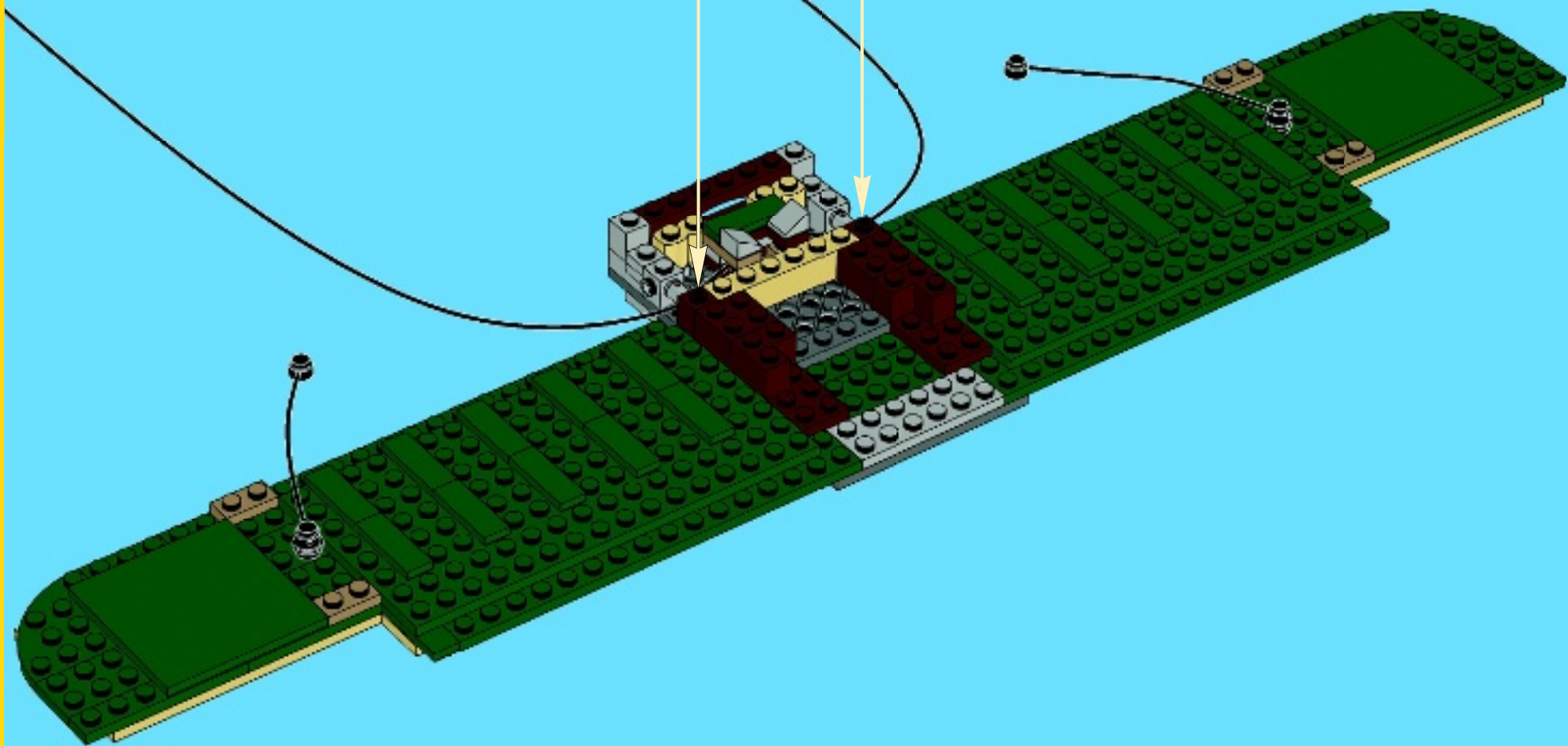
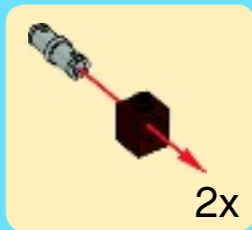

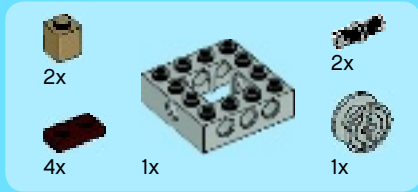

14

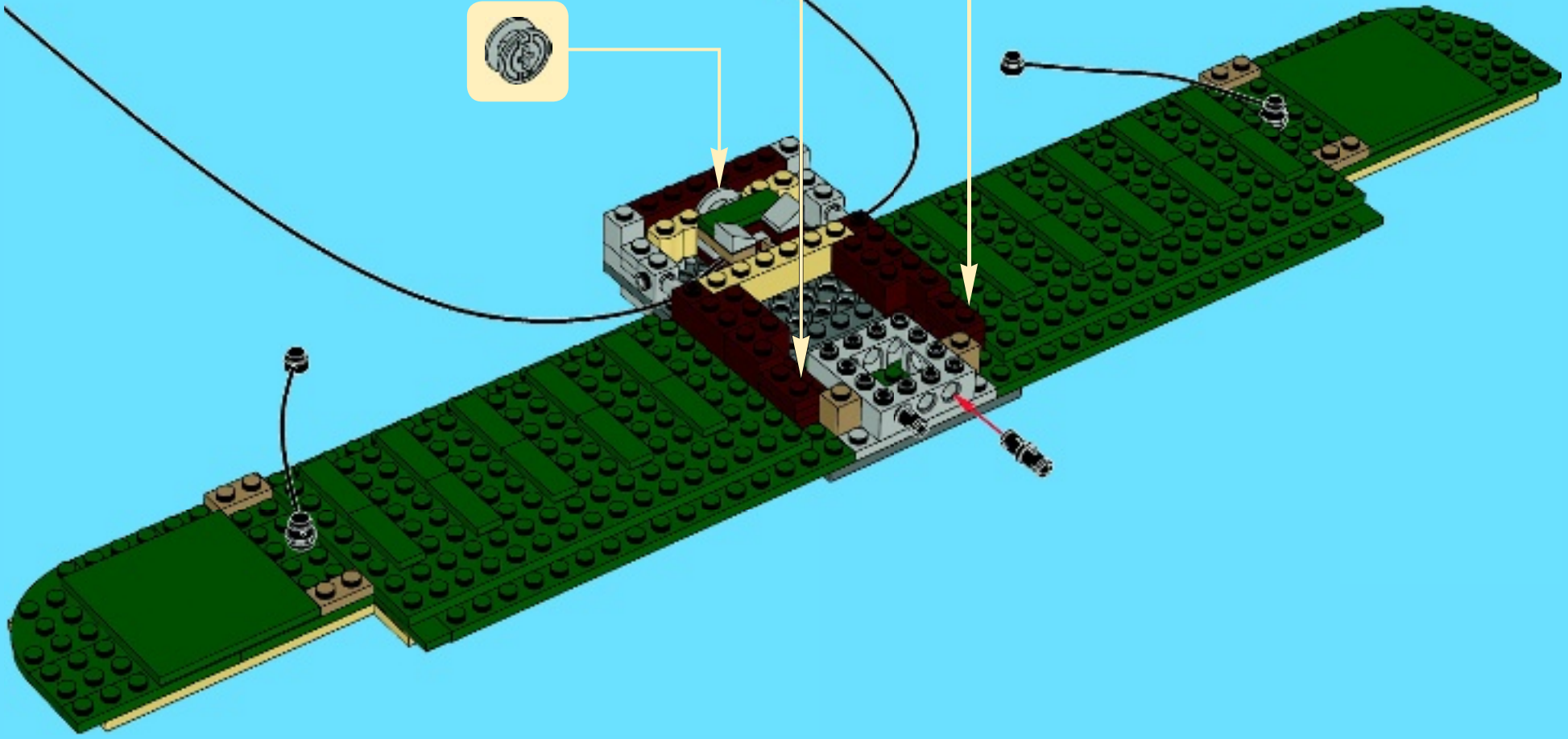
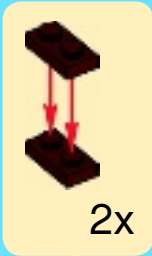

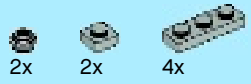

15

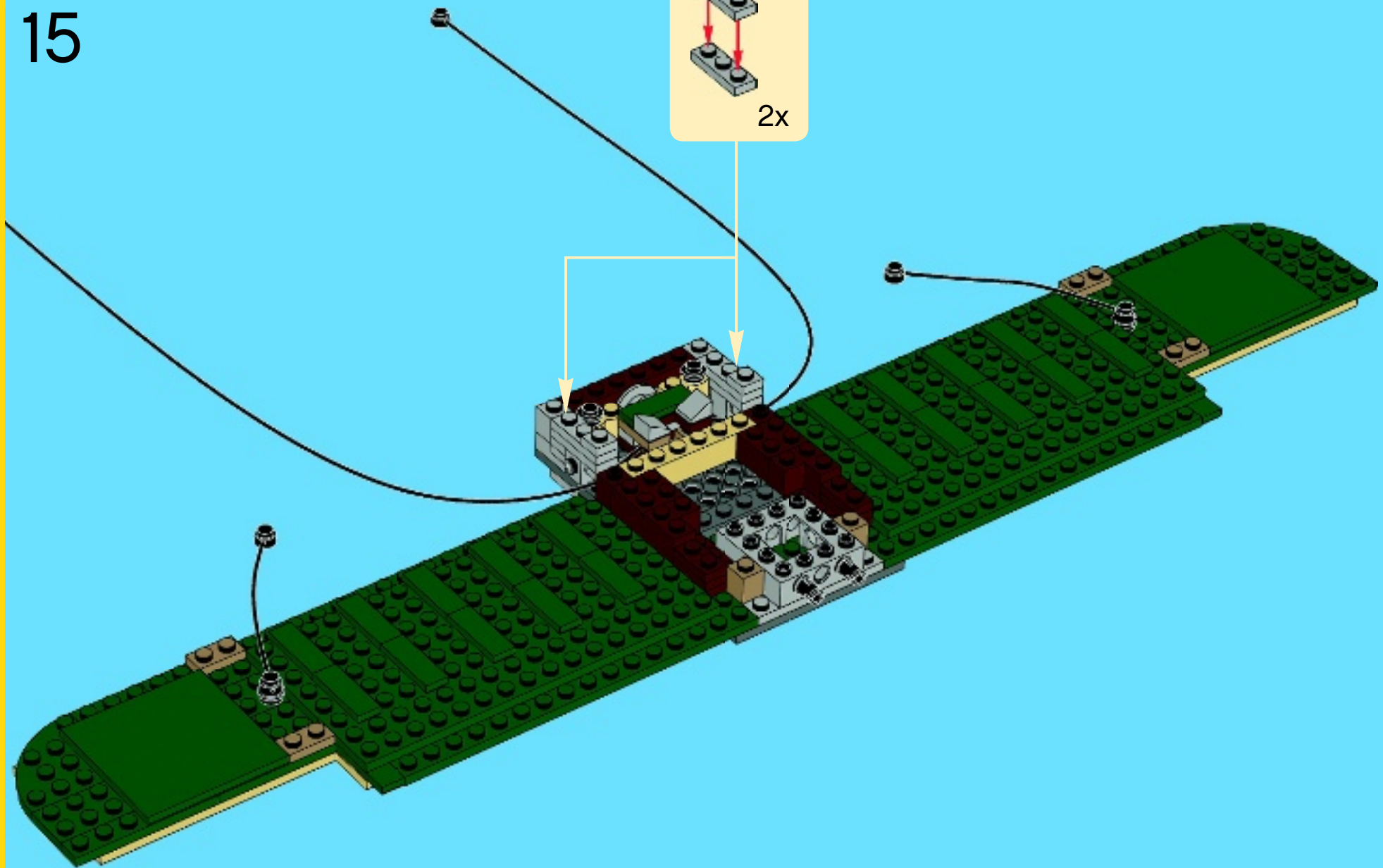
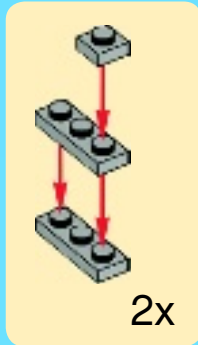





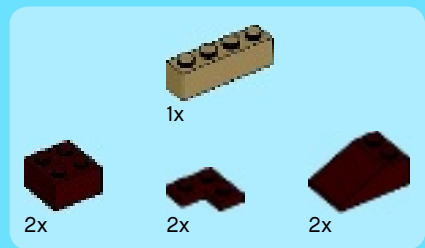

17

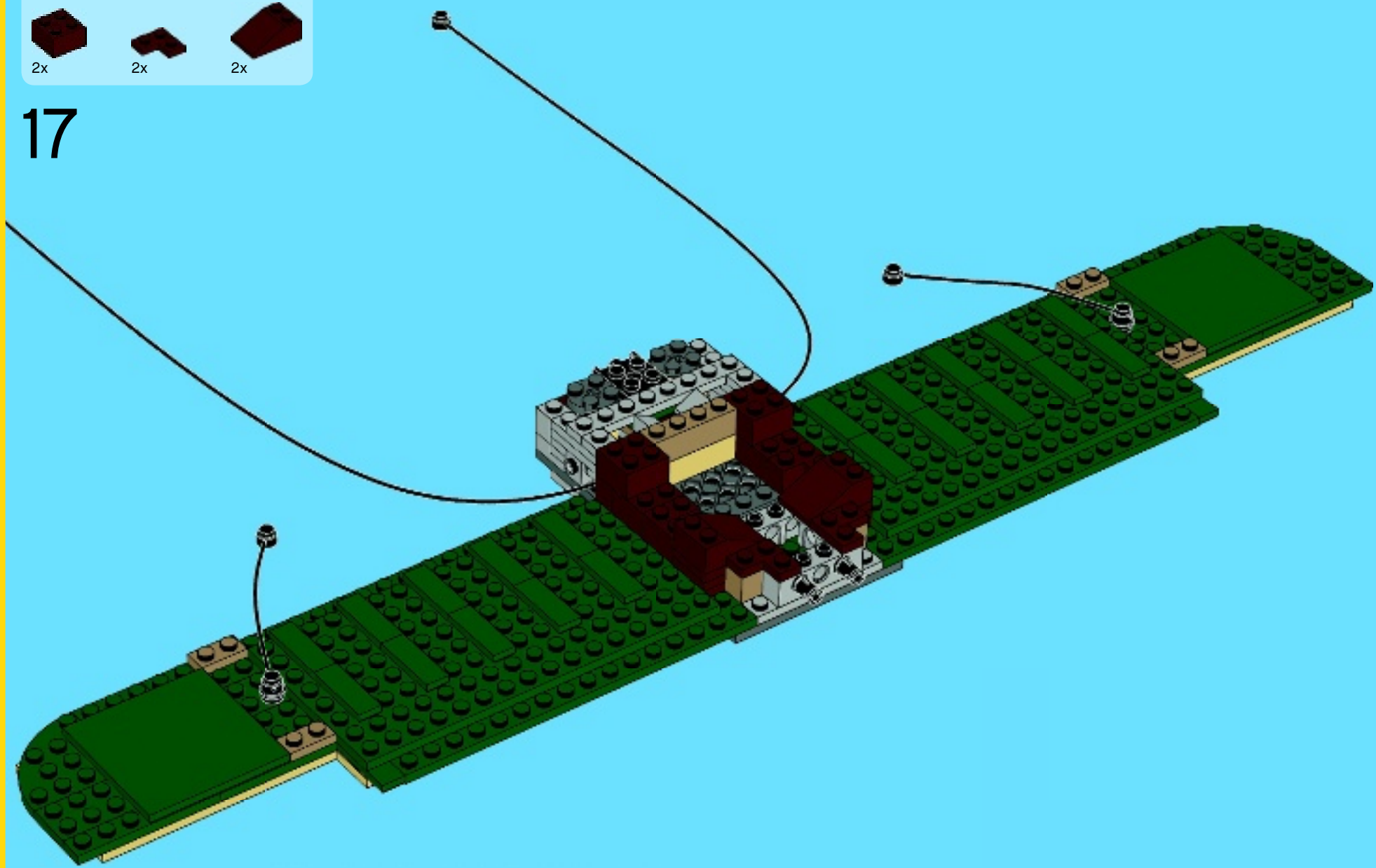

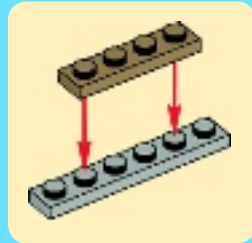
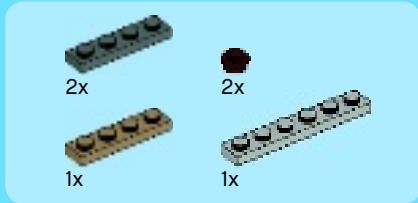

18

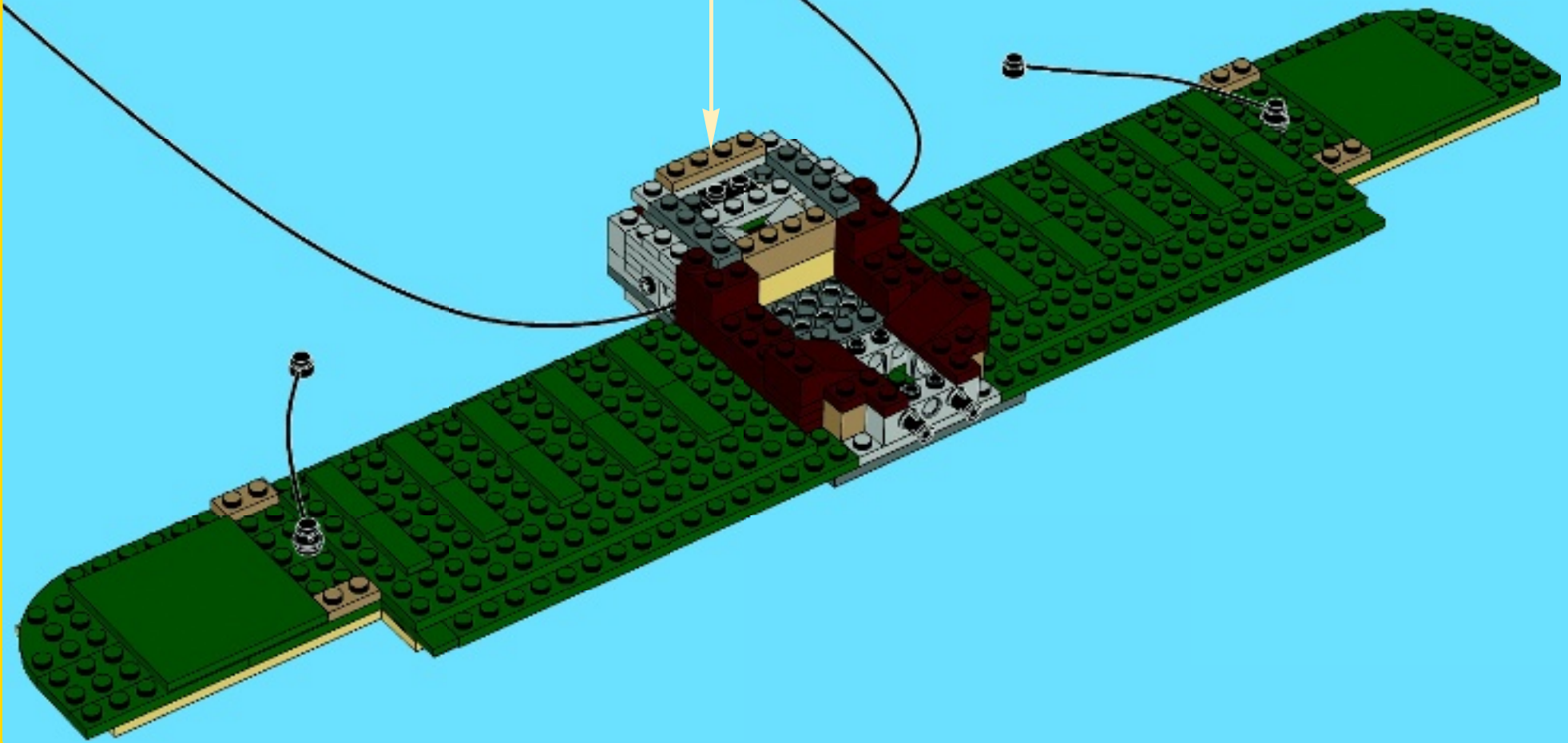

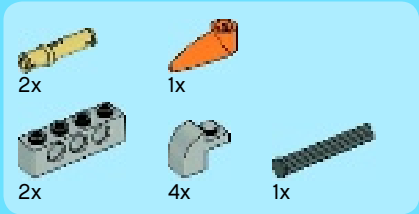

19

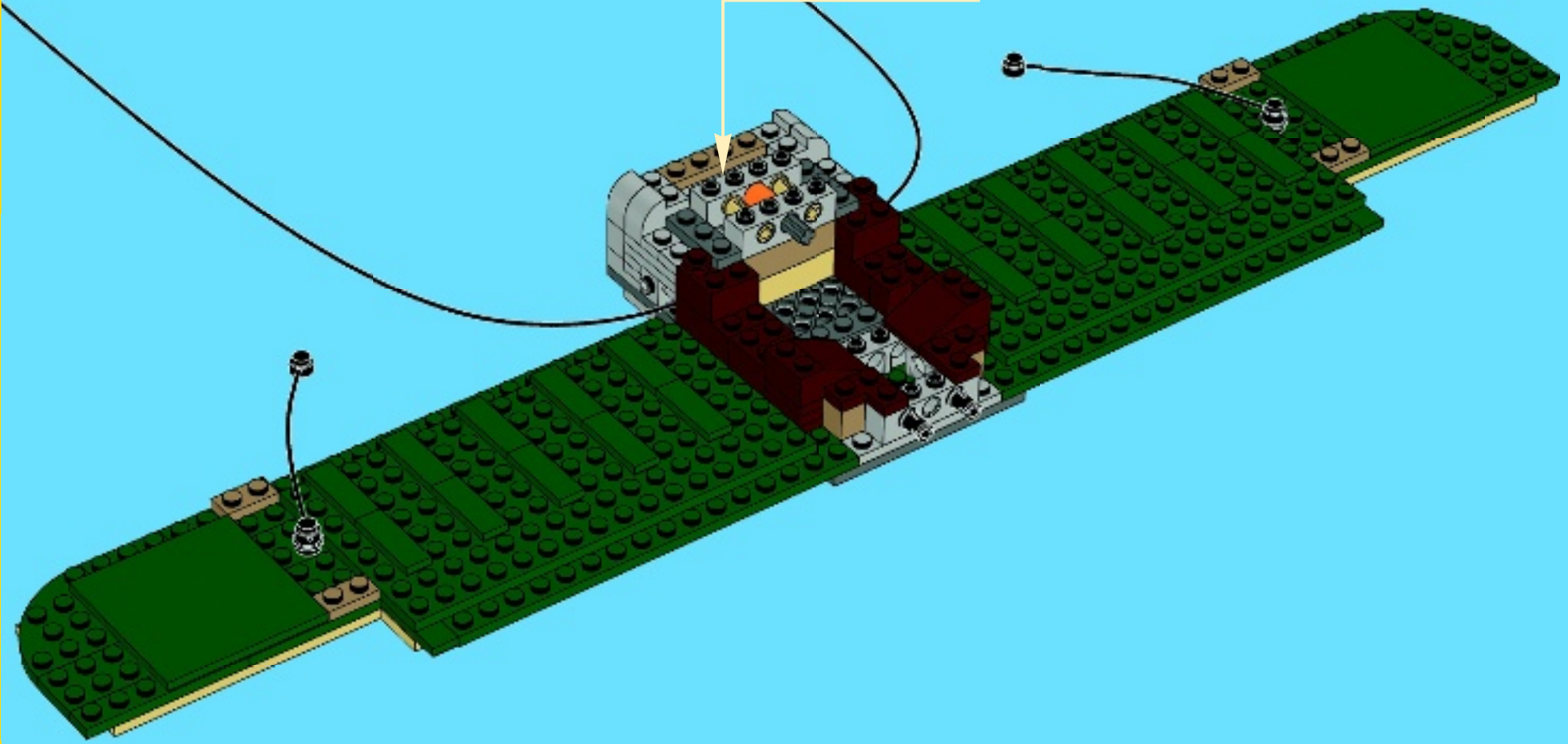
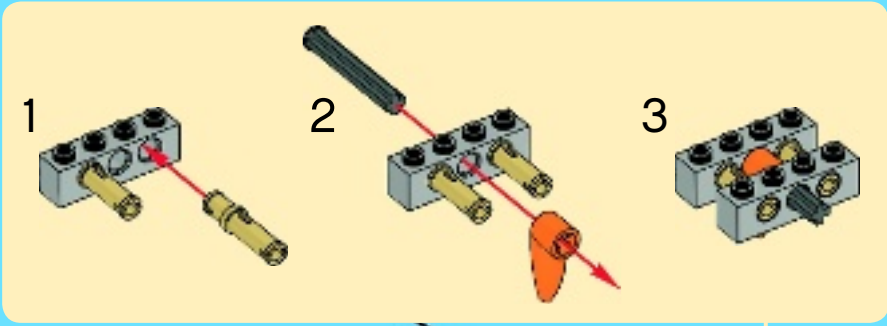



2x



2x



2x

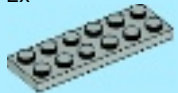

1x

# 20

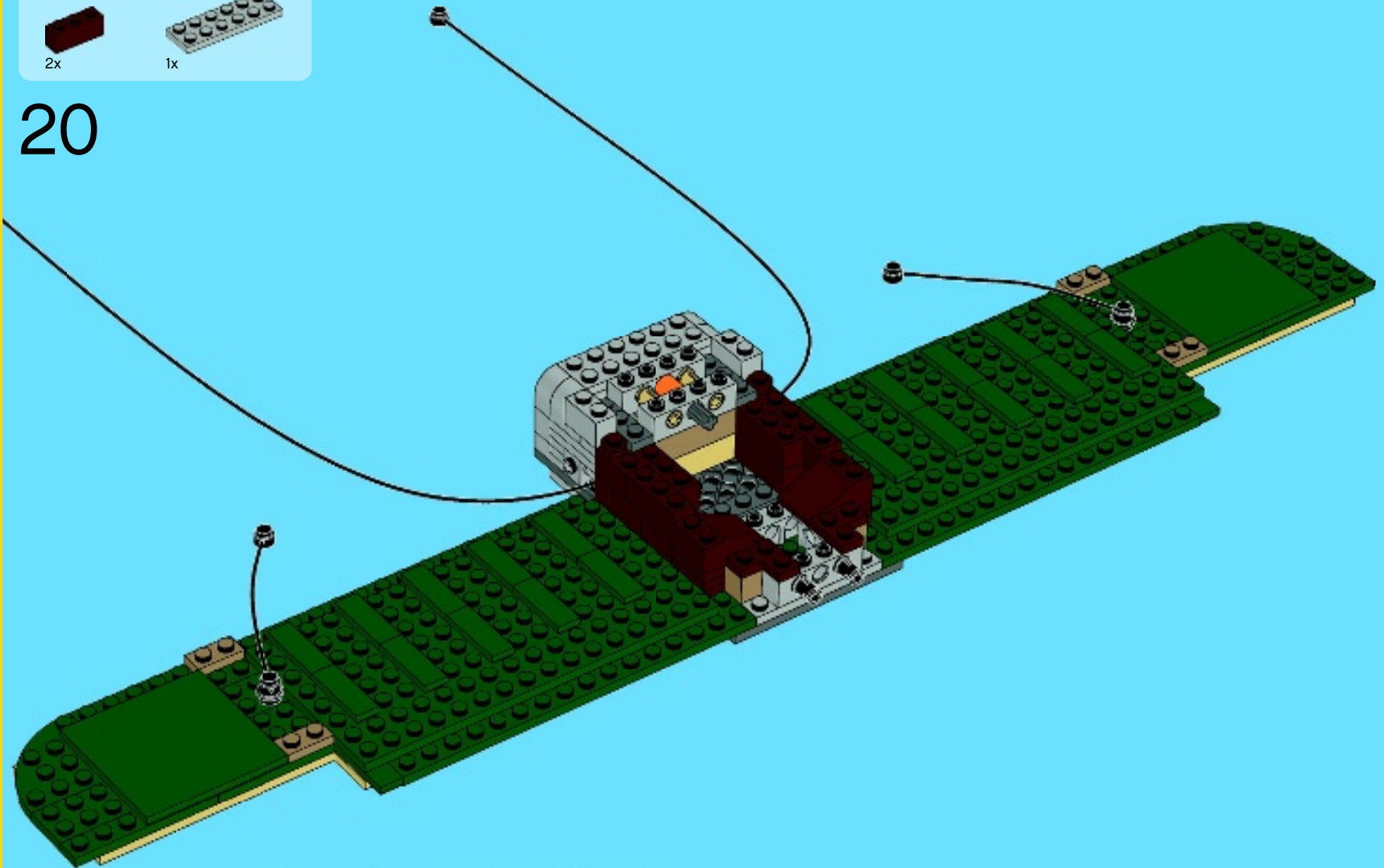

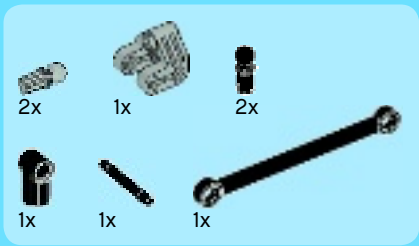

# 21

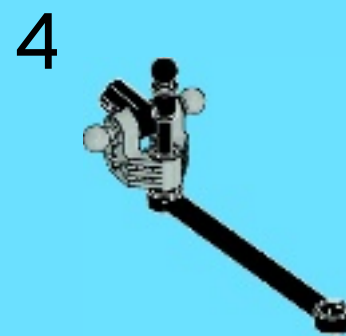
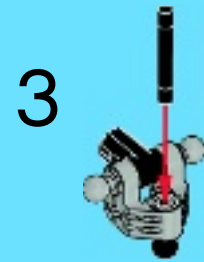
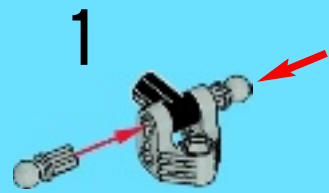

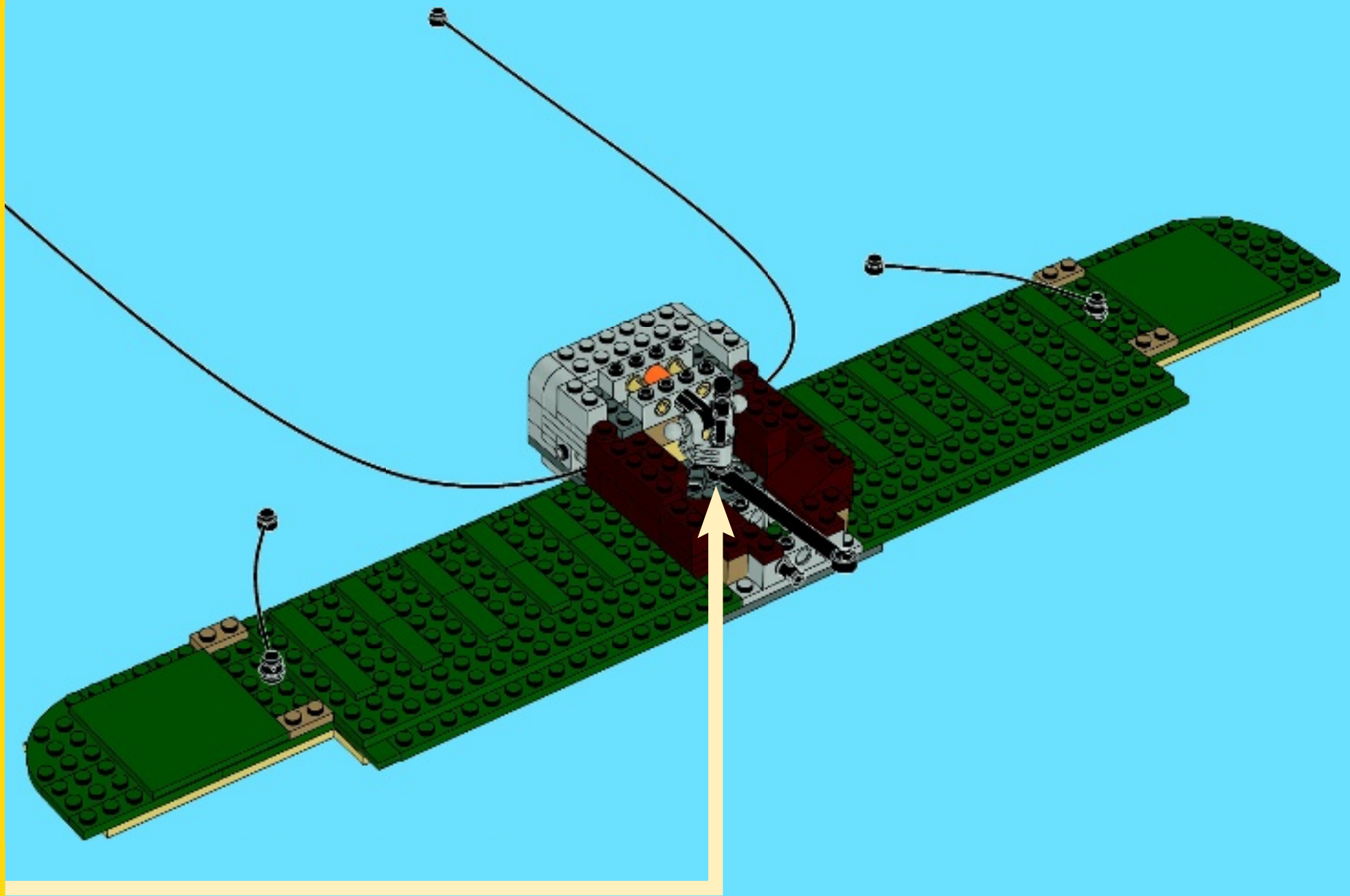



22

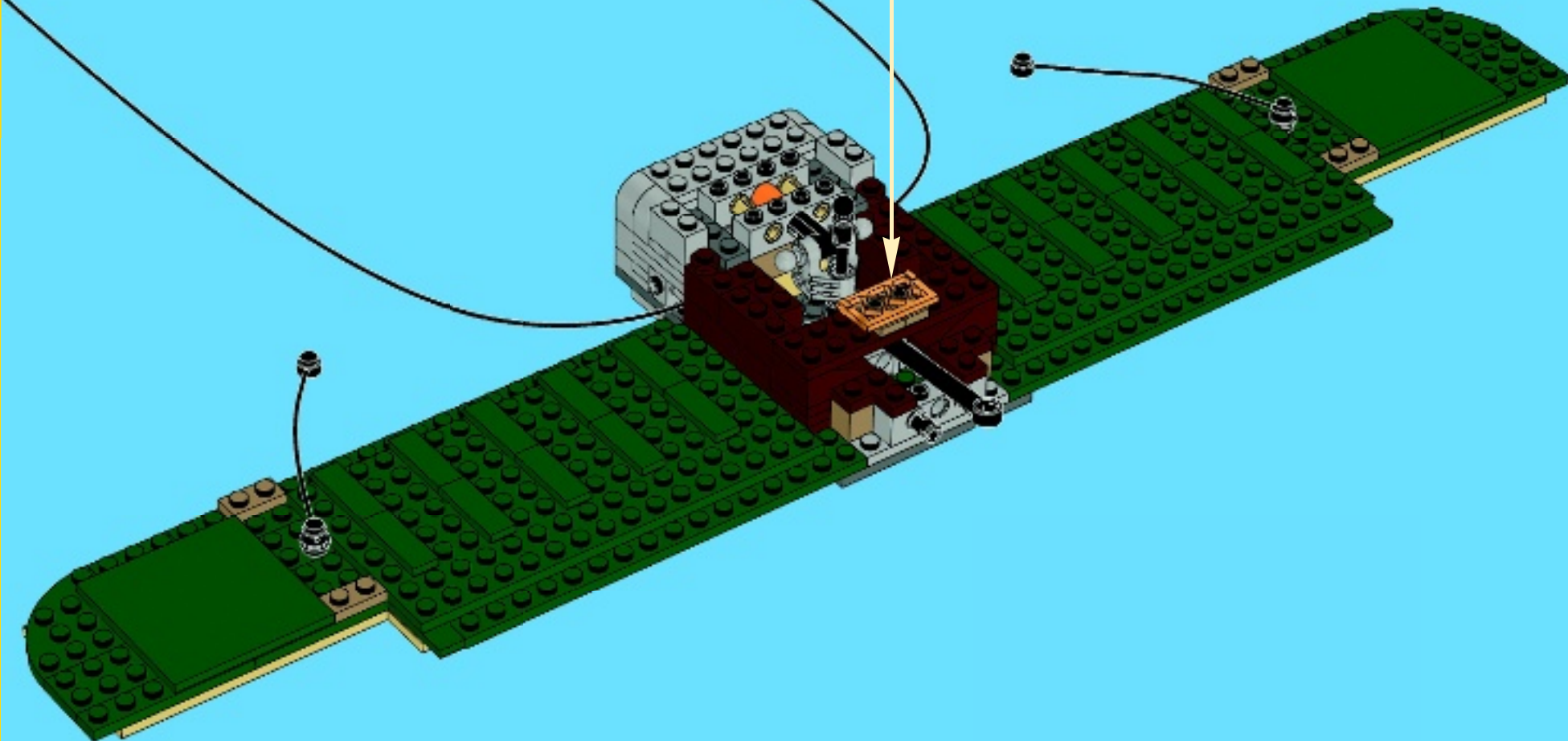
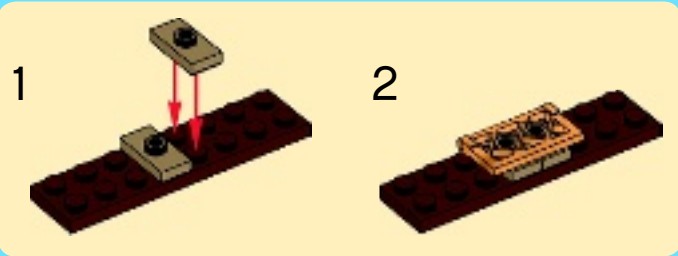



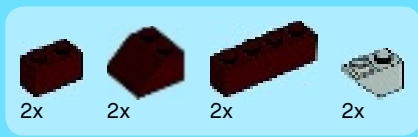

23

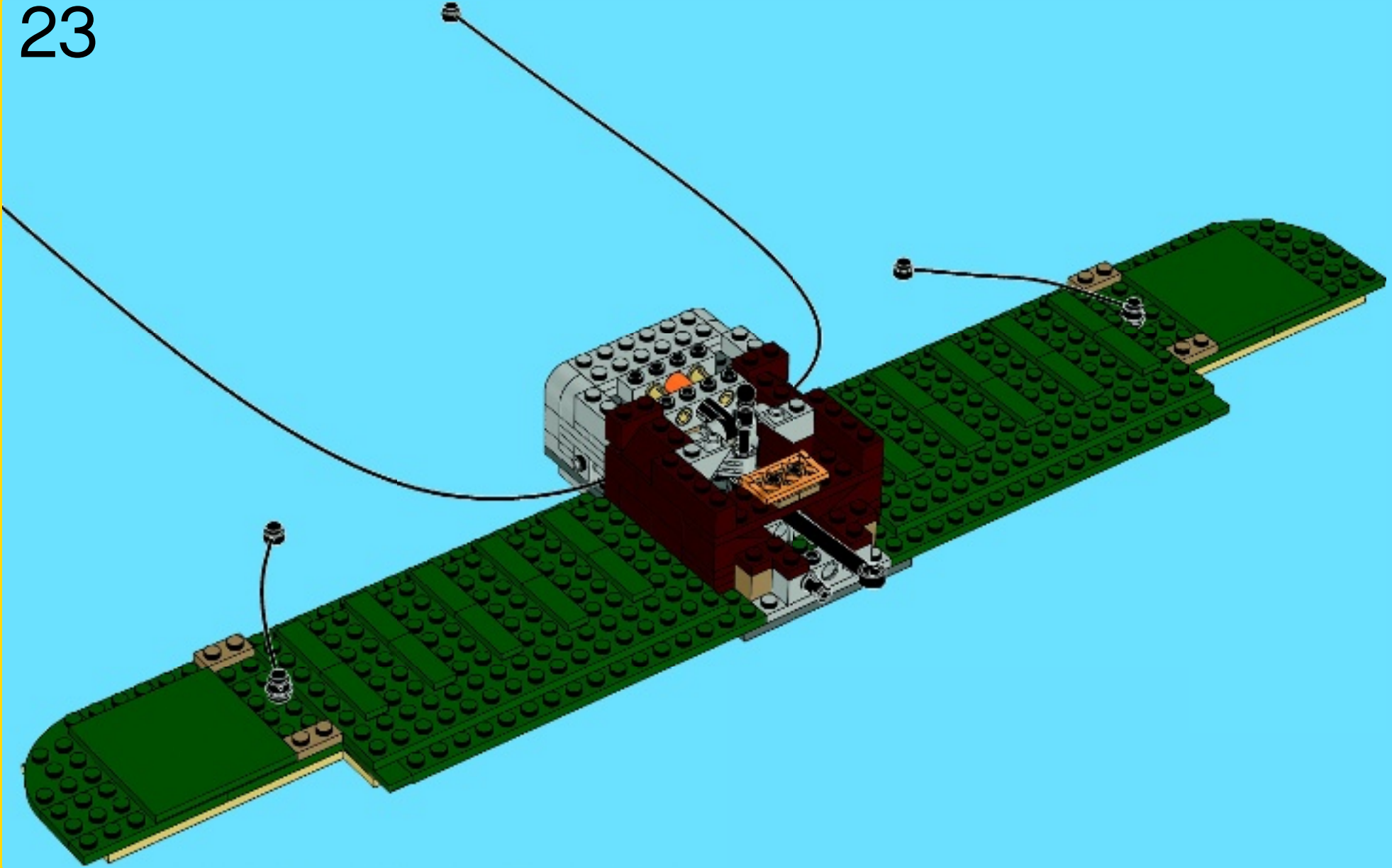



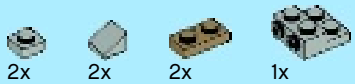

25

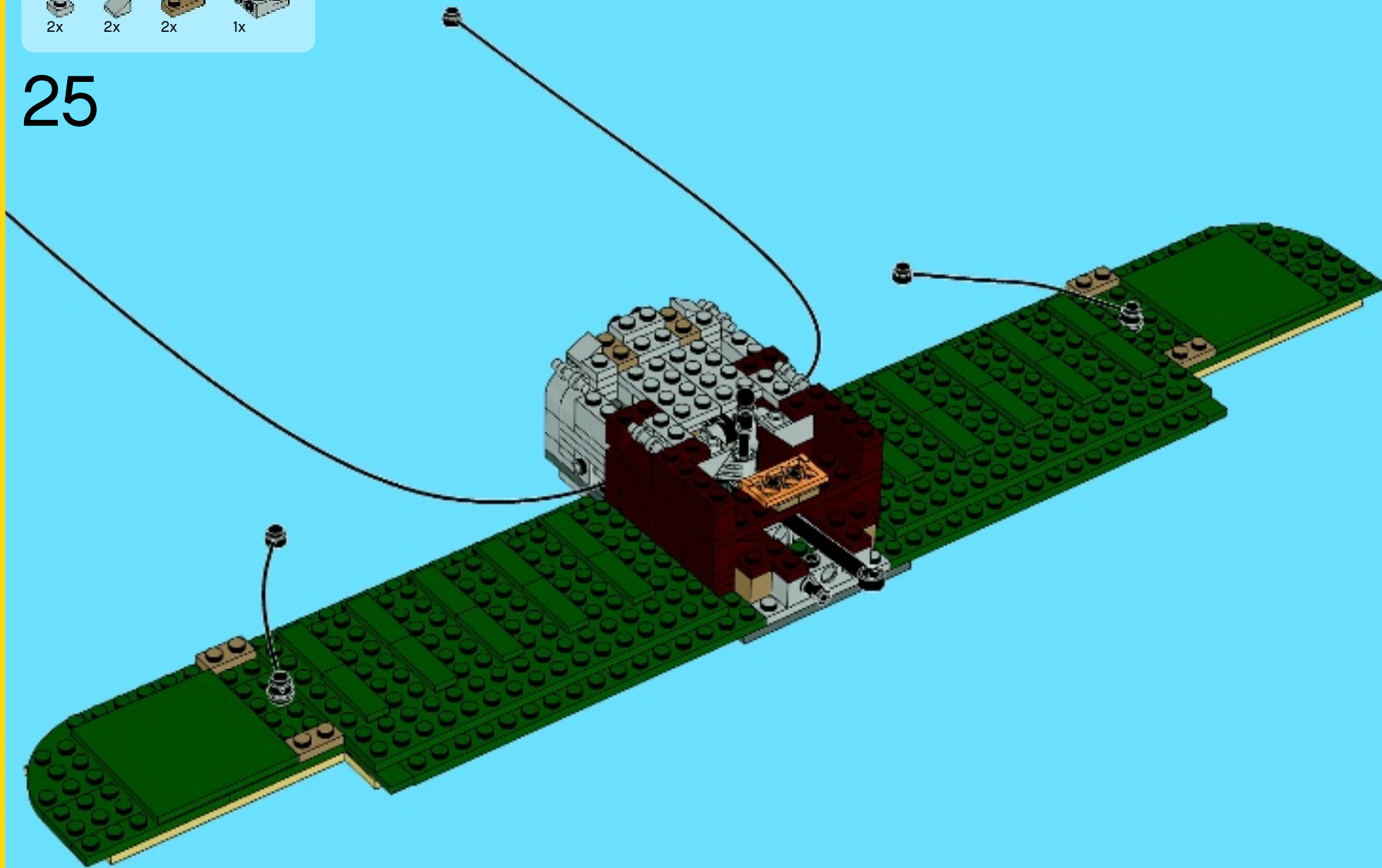



2x



1x

26

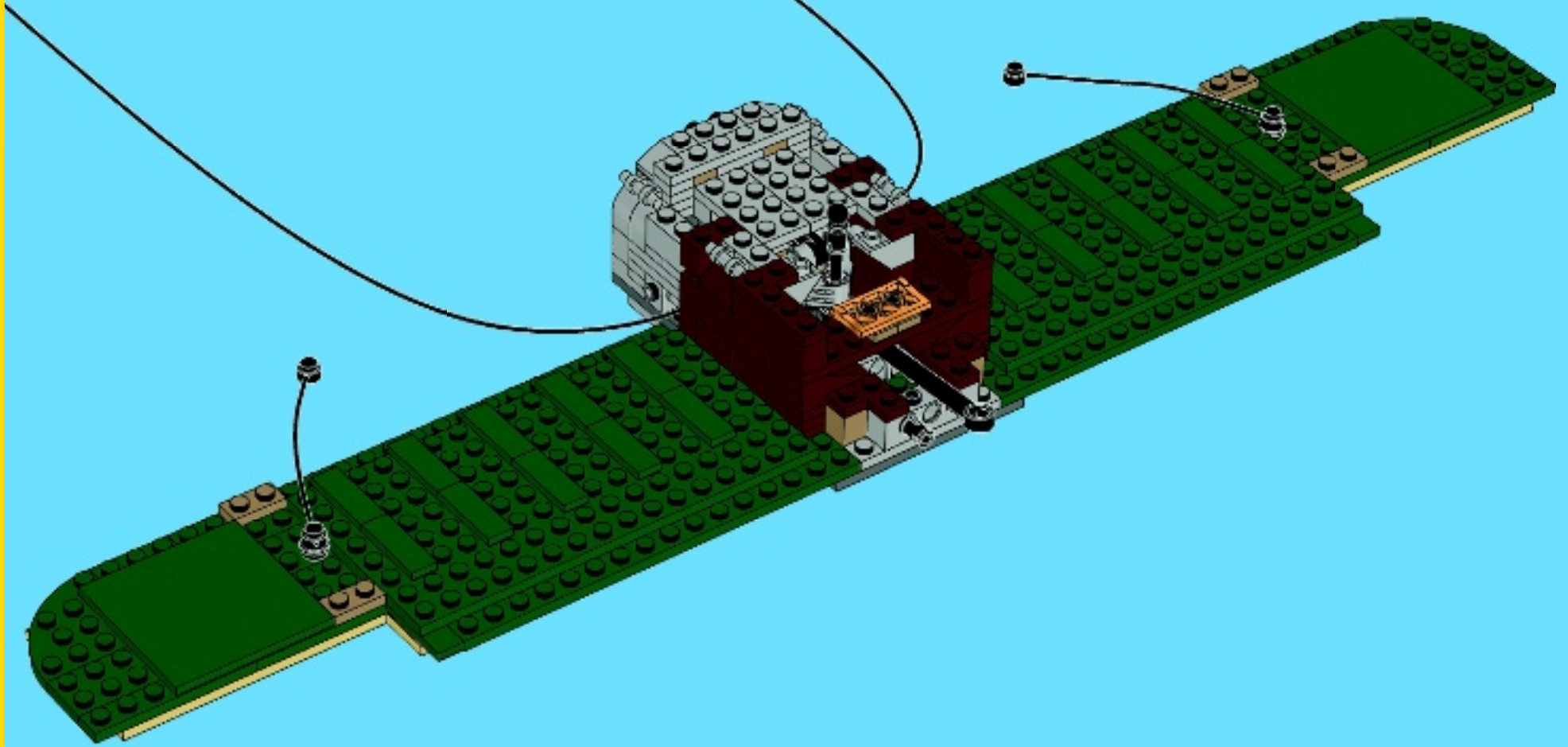



27

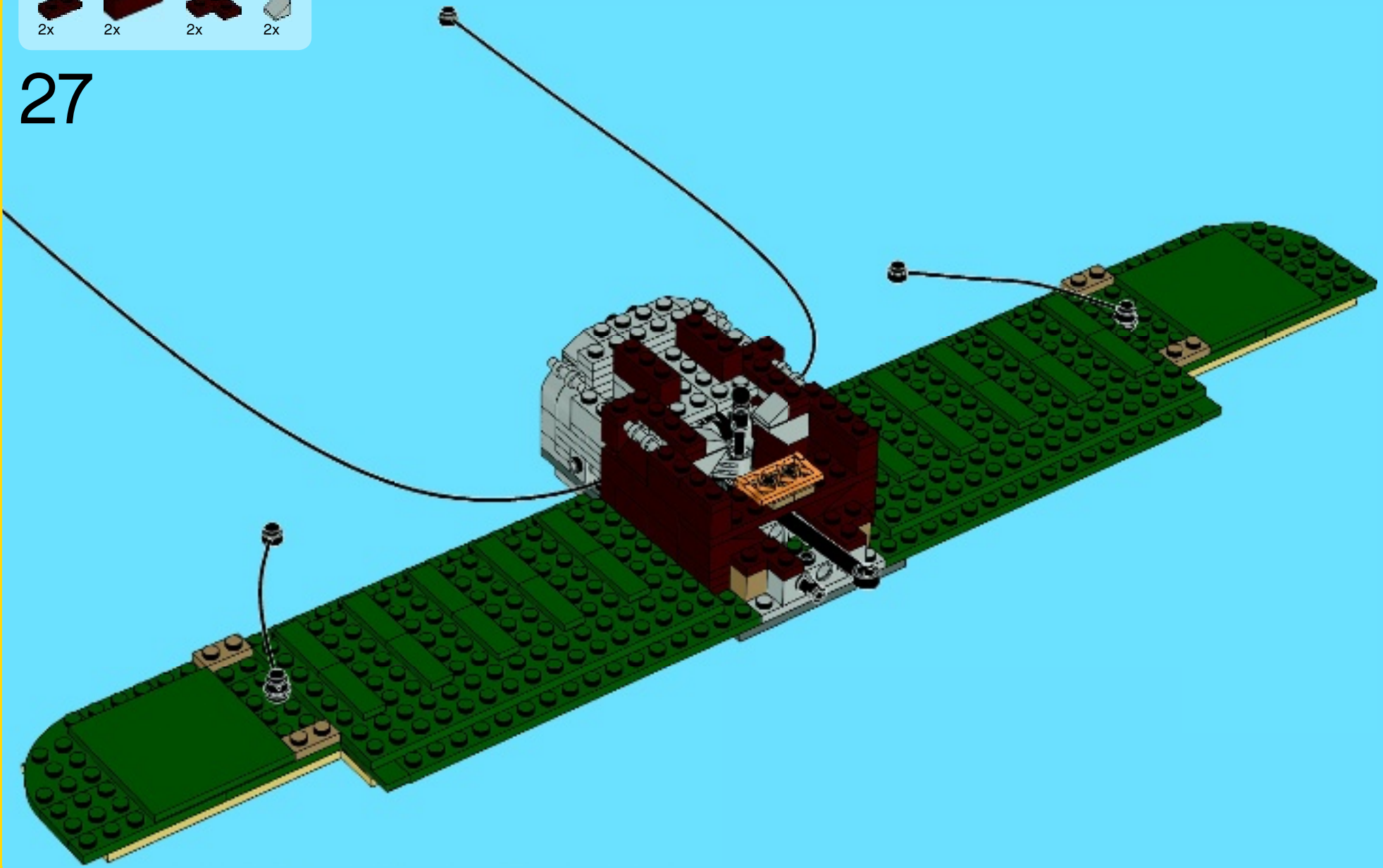

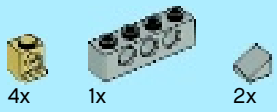

28

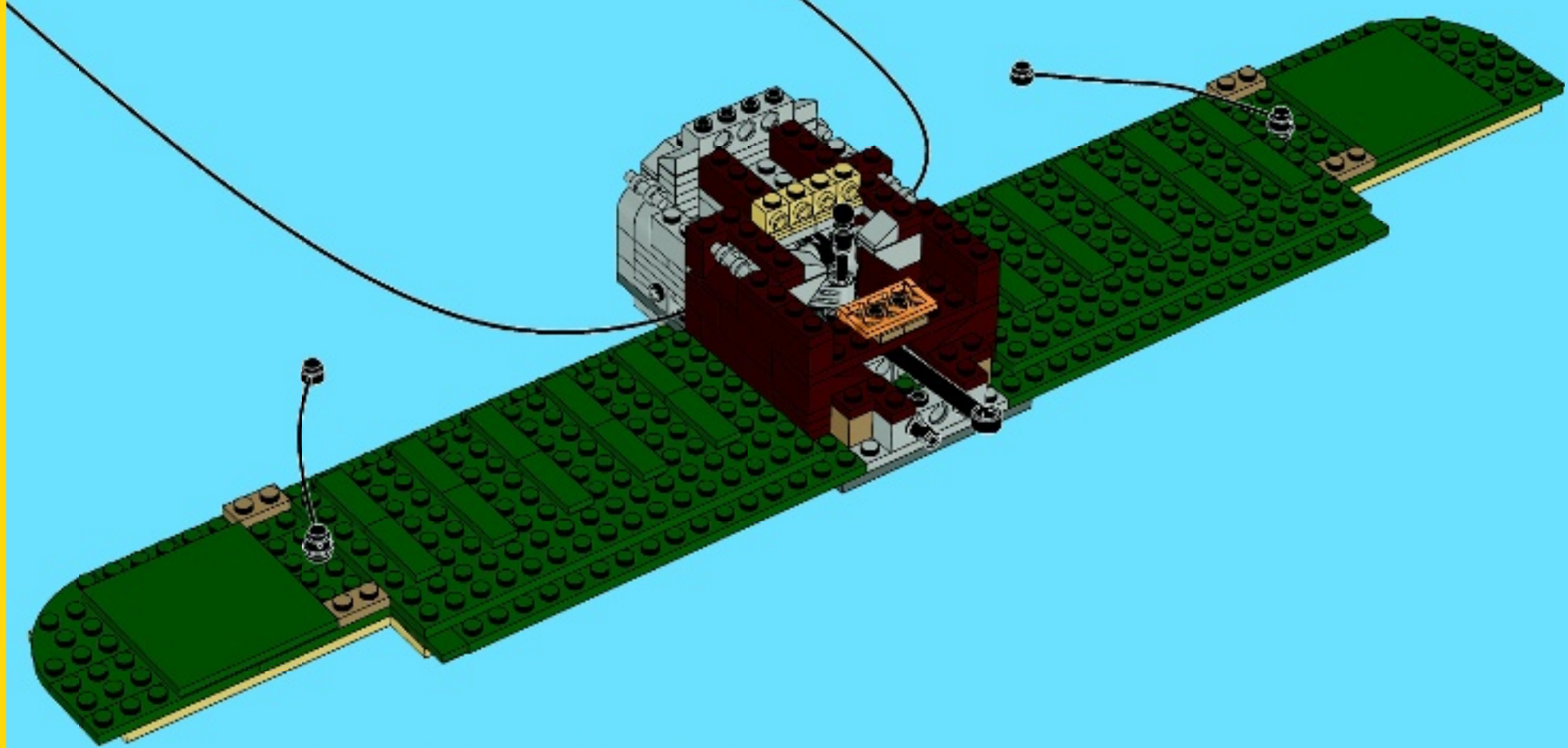



1x



4x

# 29

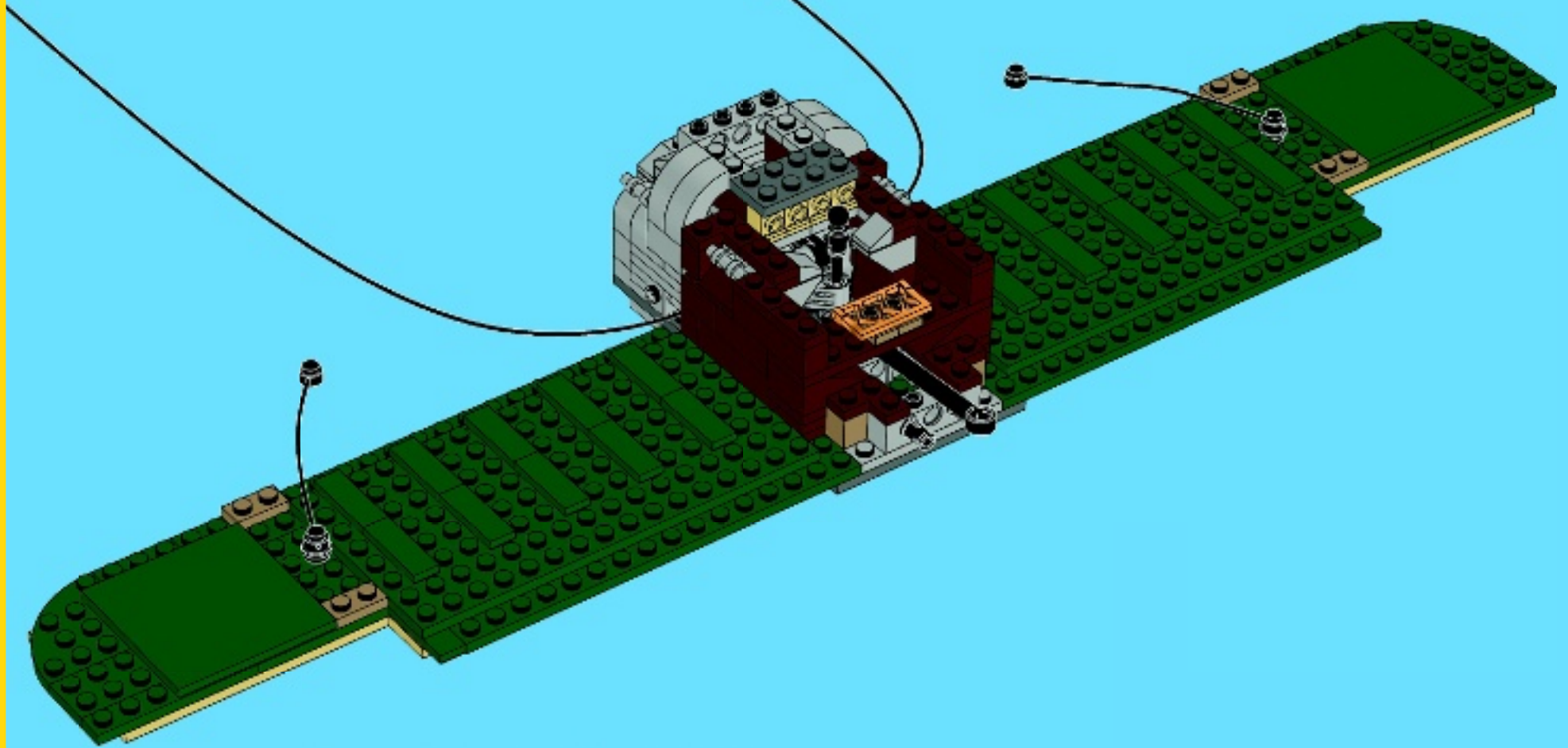



1x



1x



4x



2x

# 30

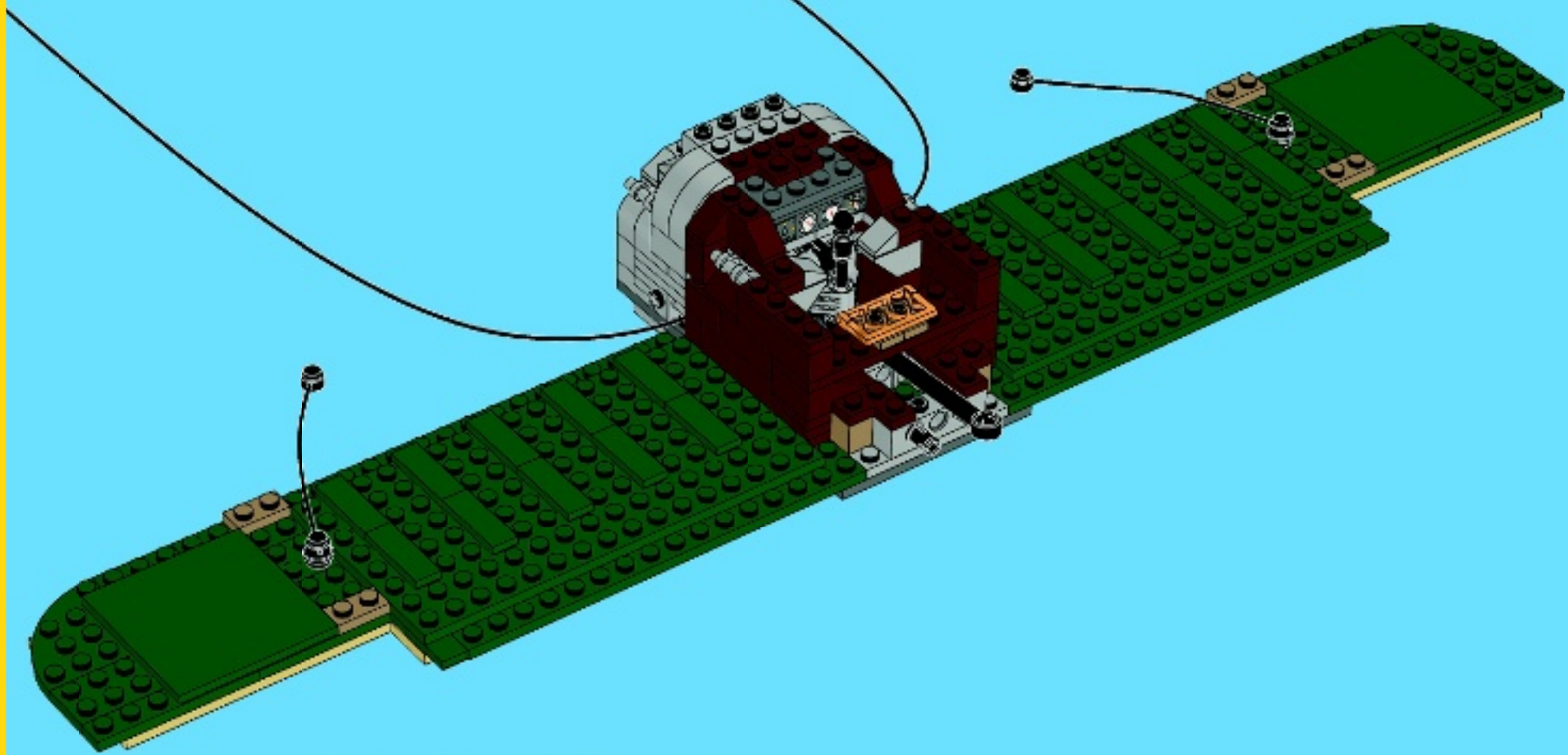



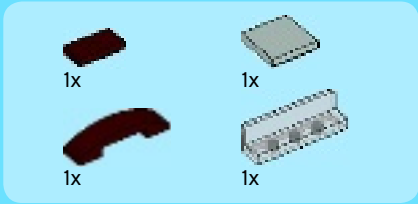

31

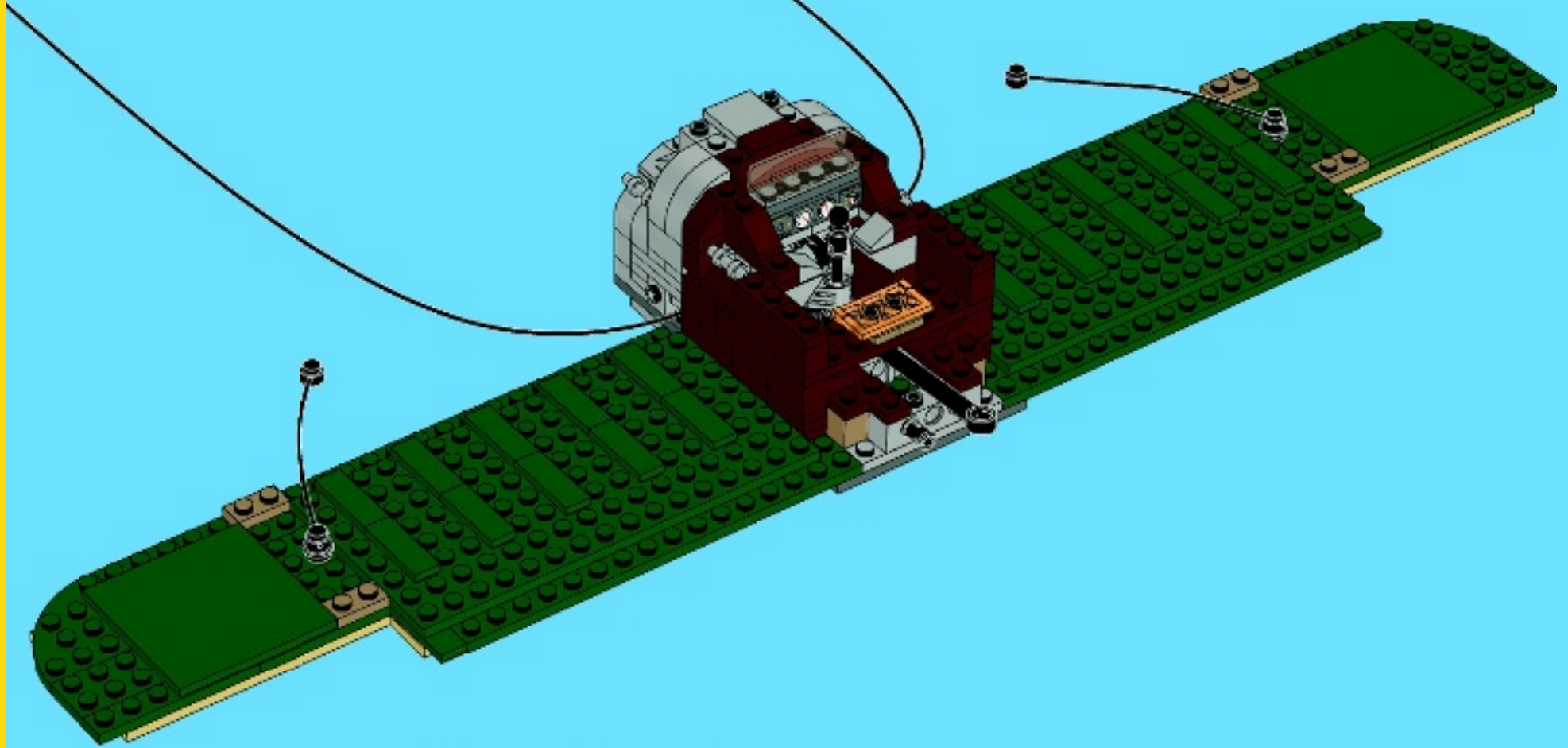

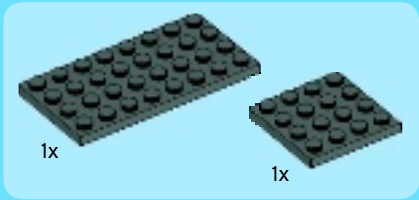
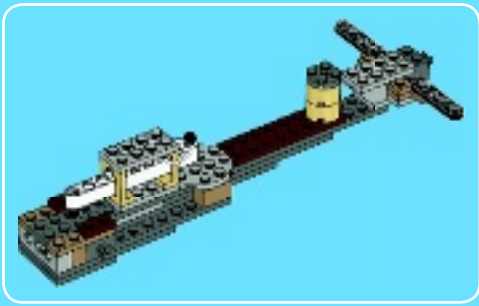

1

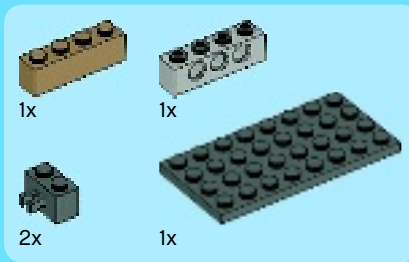
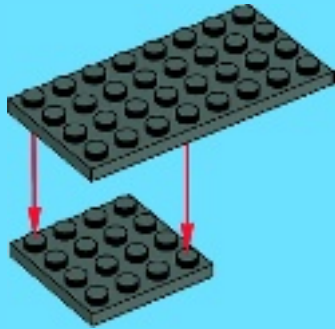

2

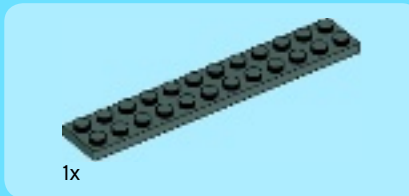
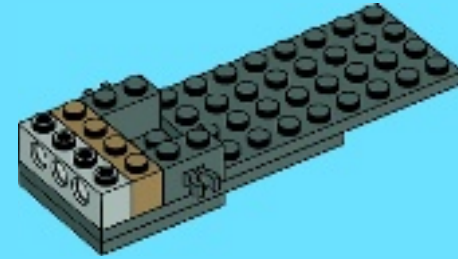

3

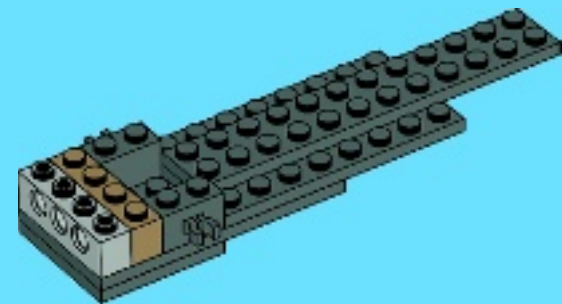

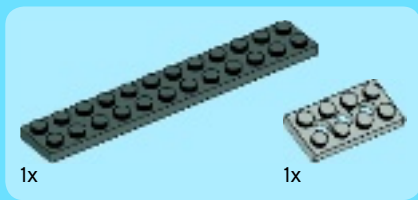

4

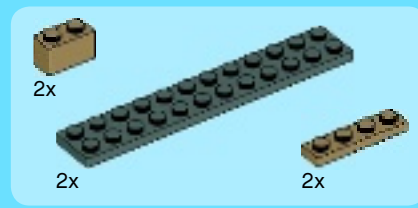
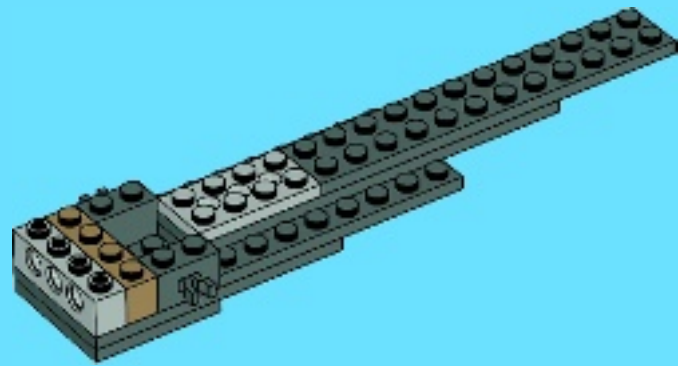

5

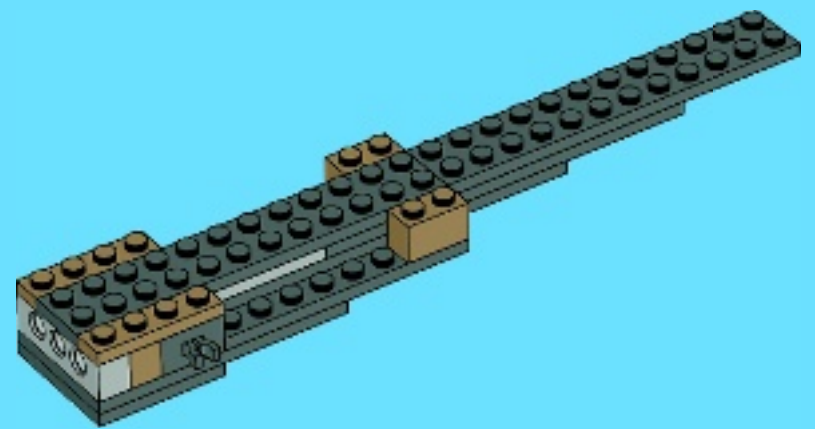

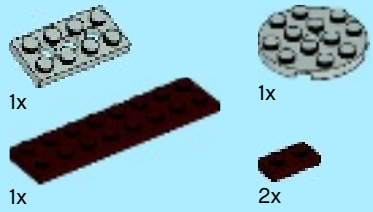

6

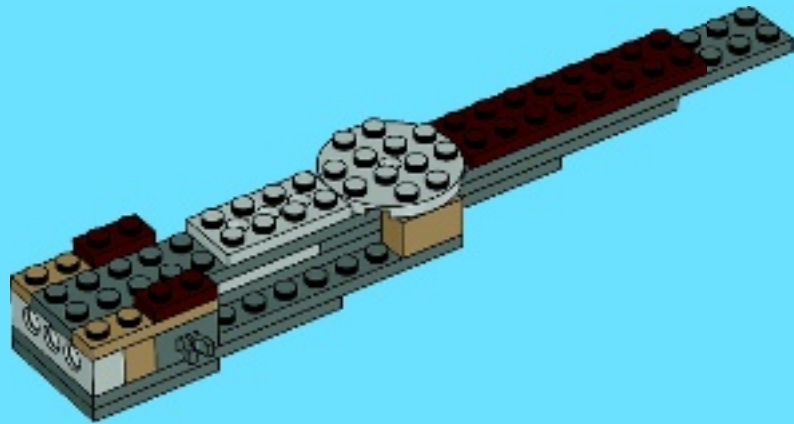

2x

7

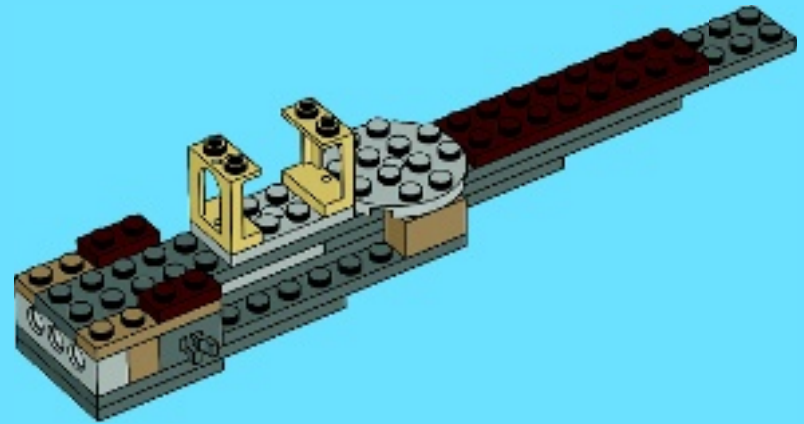



8

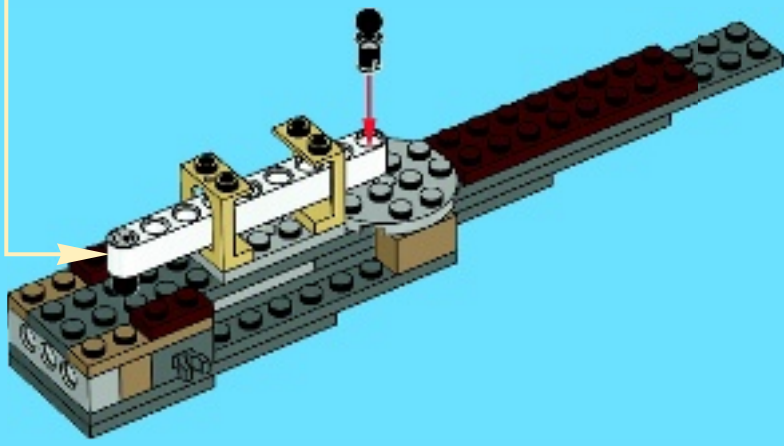
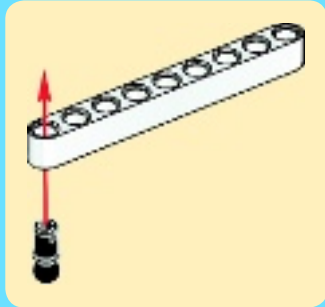

9

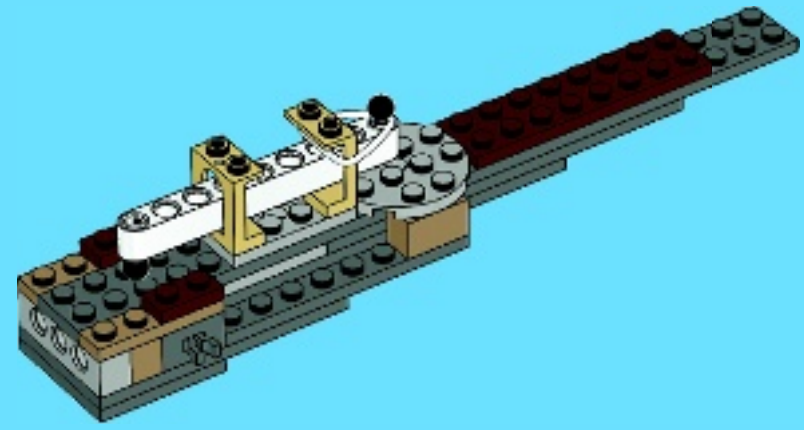



2x



1x



1x

# 10

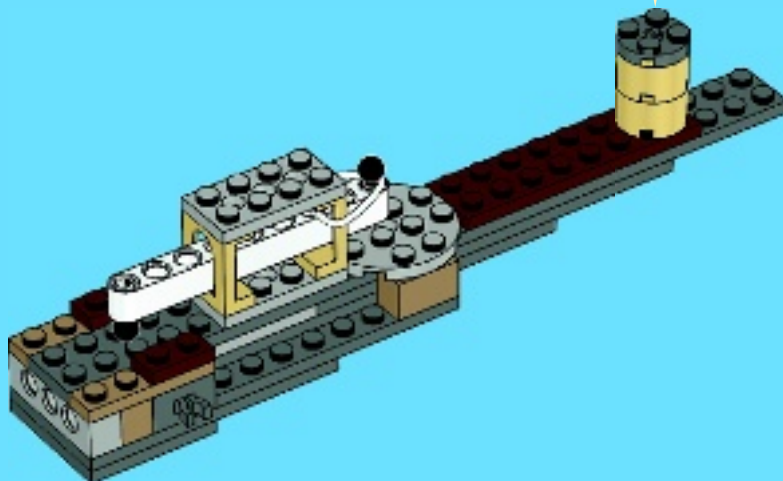

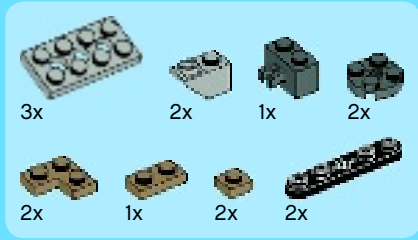

11

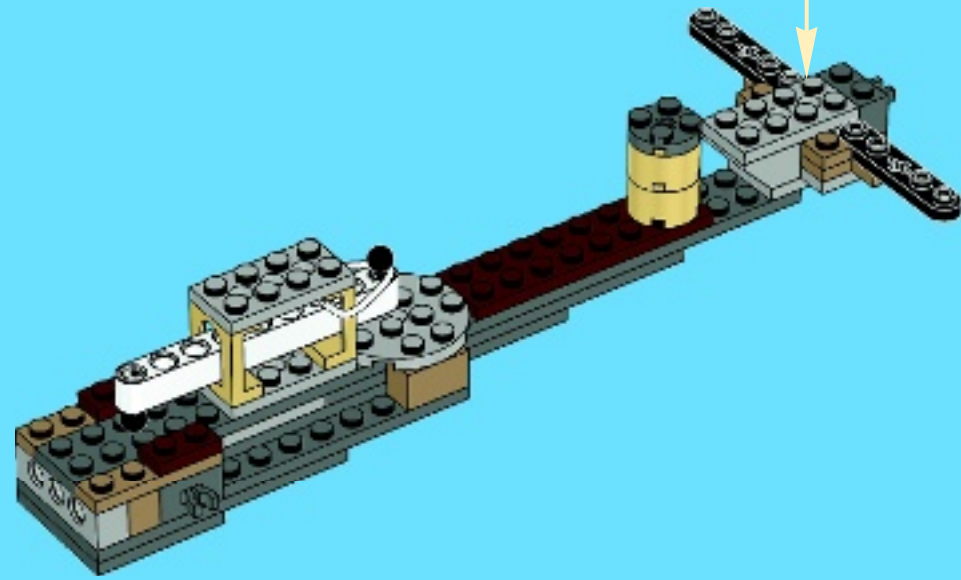
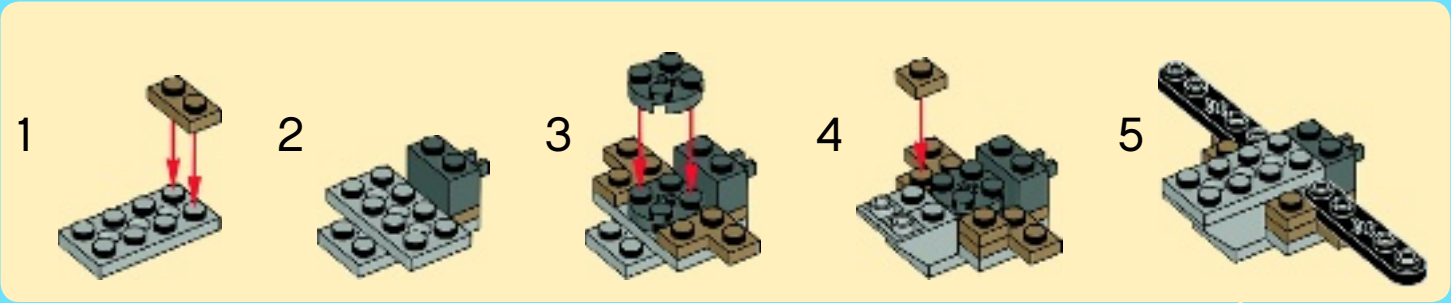

32

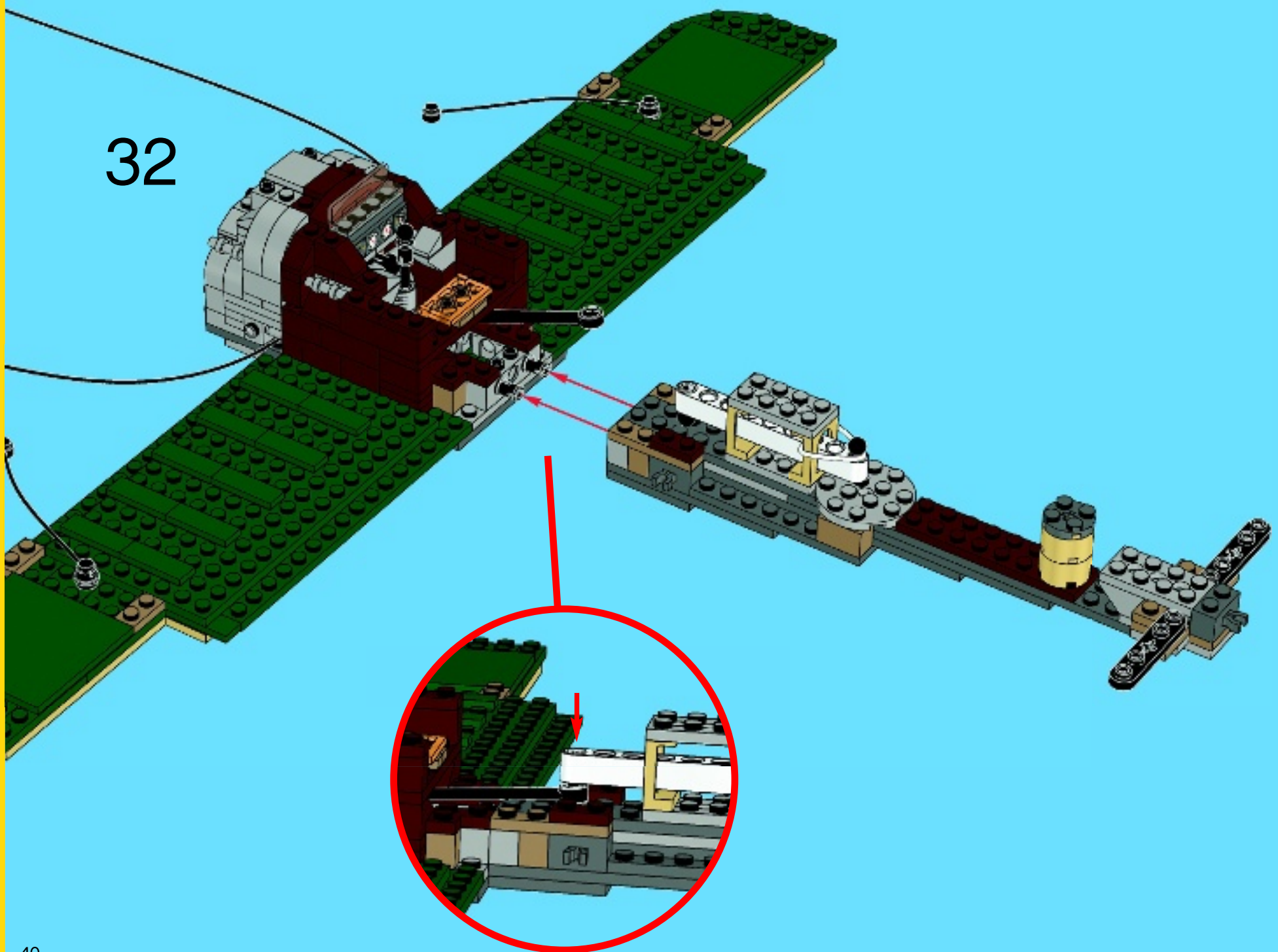



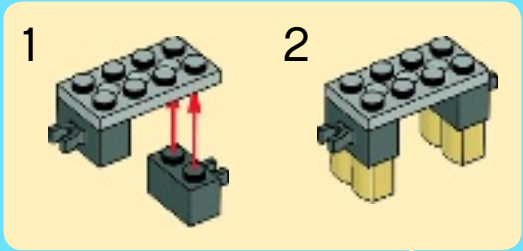
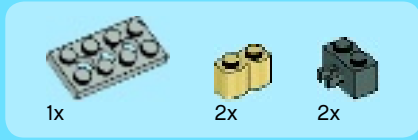

33

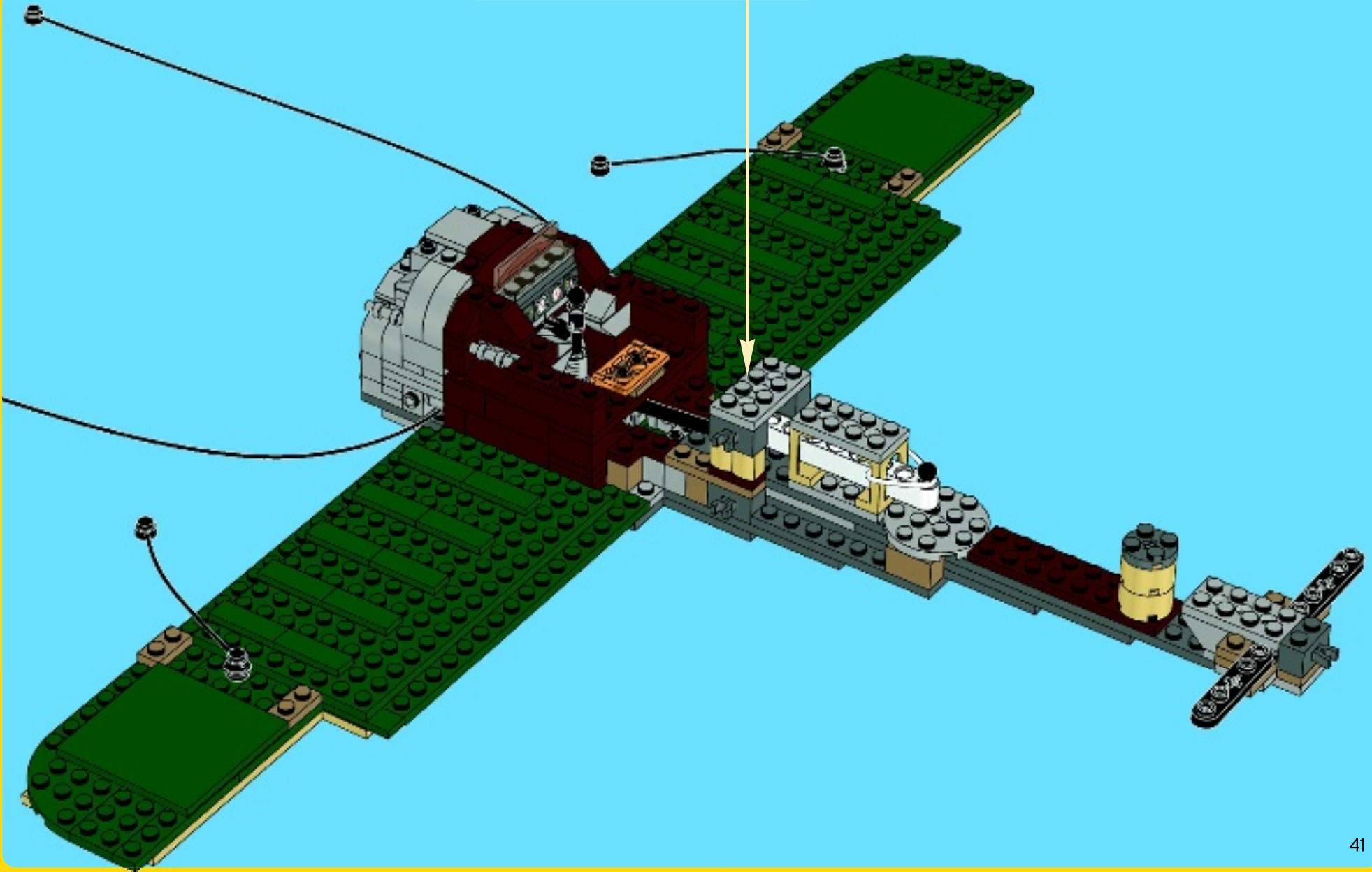

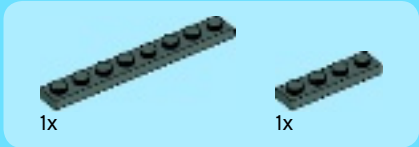
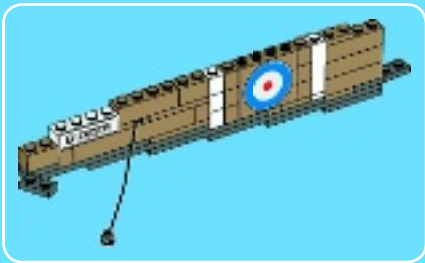

1

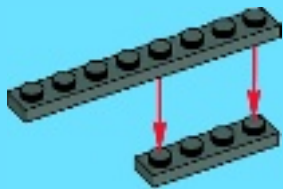

2

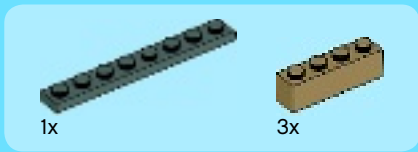
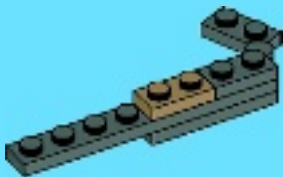

3

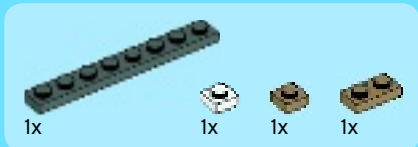
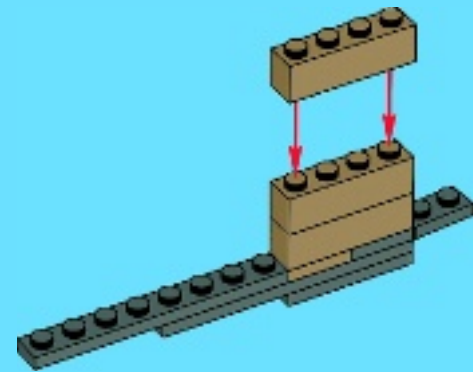

4

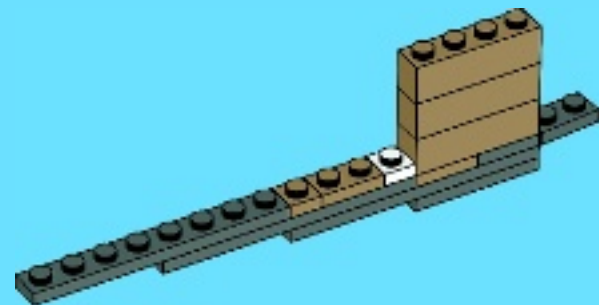

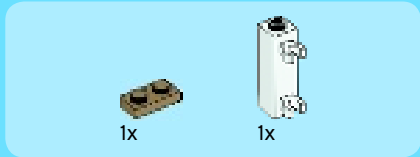

5

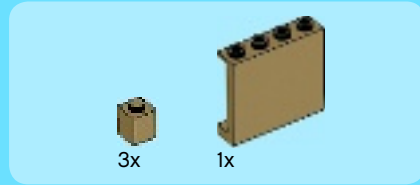
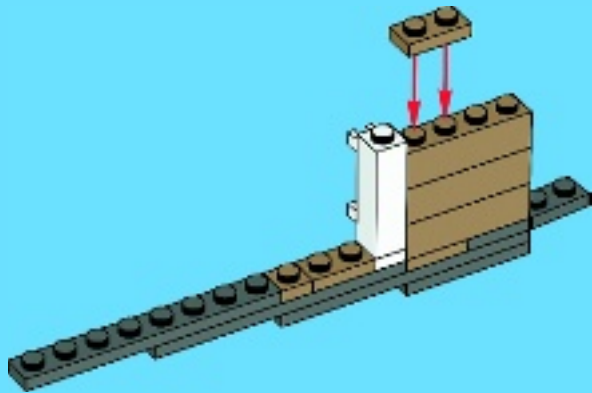

6

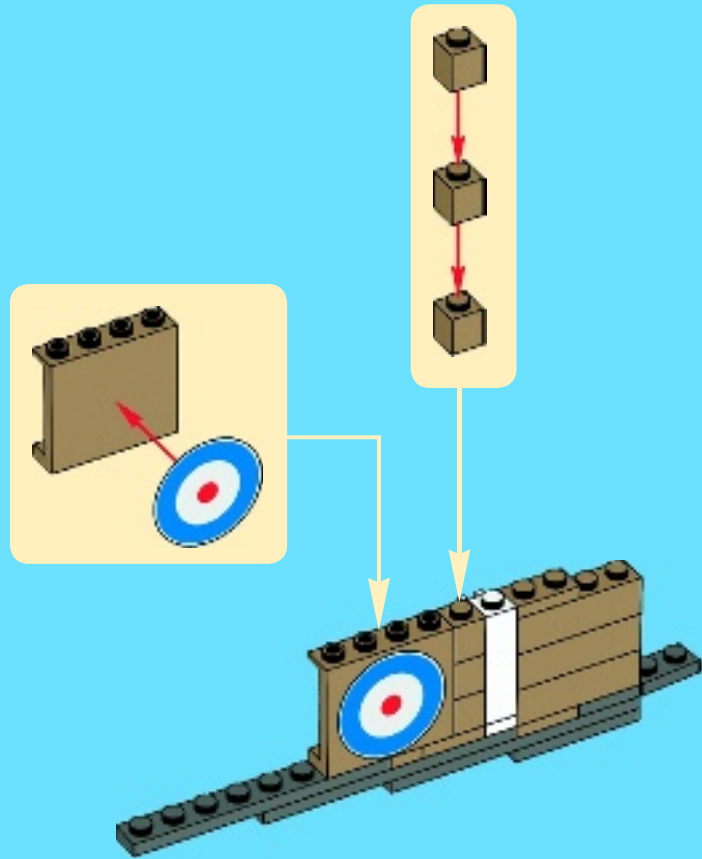



3x



3x

# 7

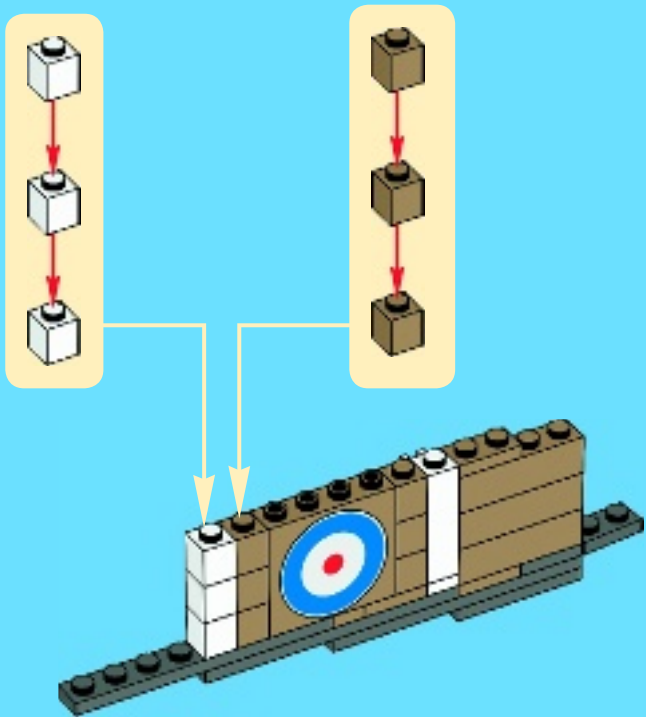

1x



2x



2x



2x

# 8

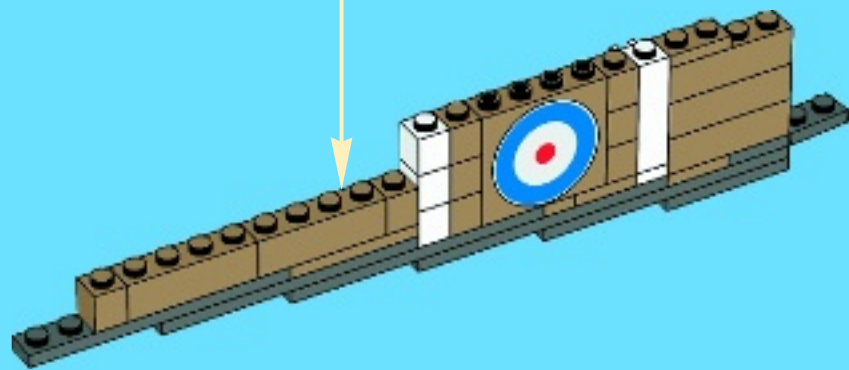
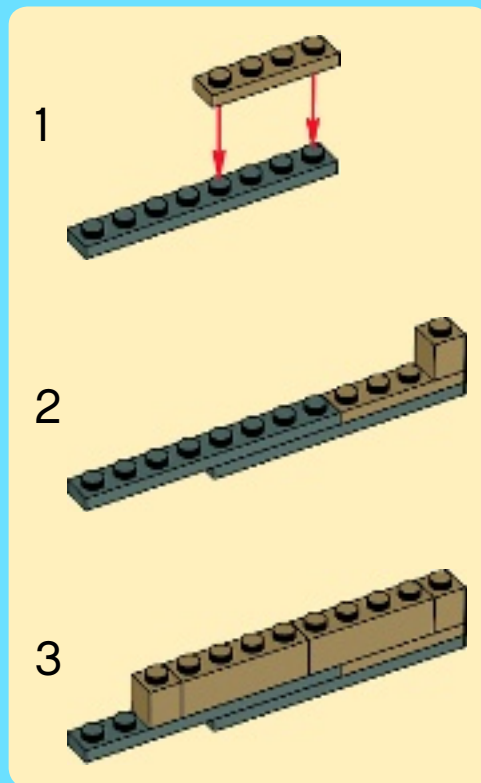

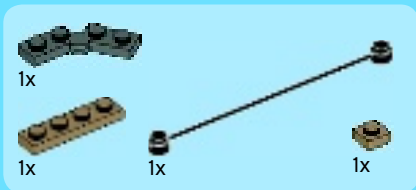

9

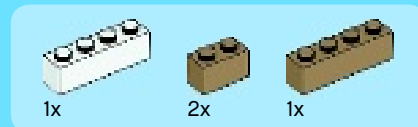
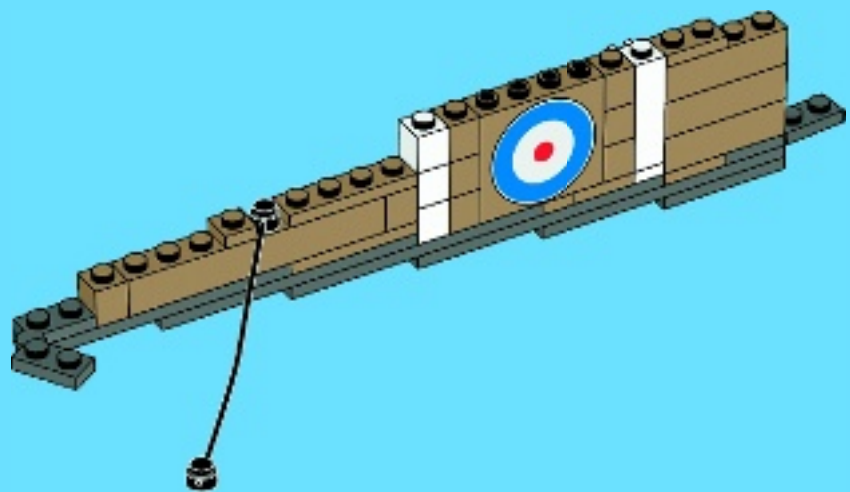

10

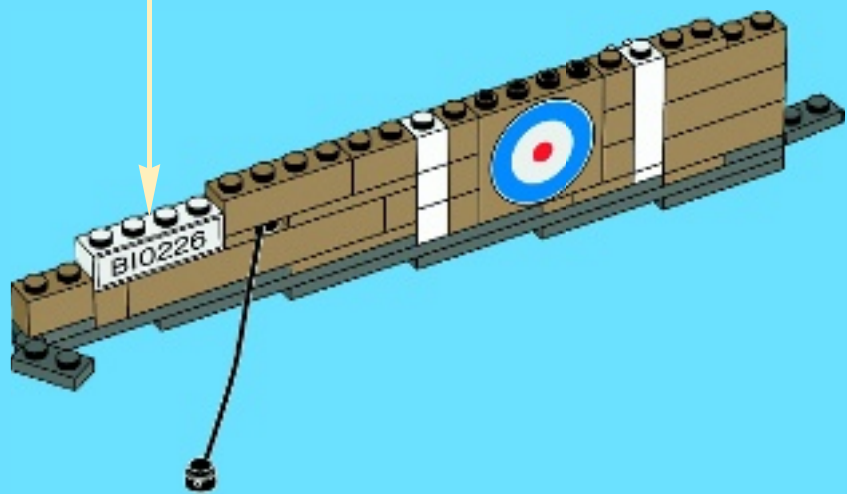
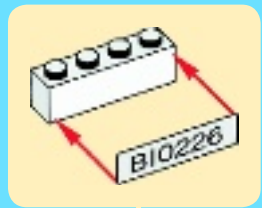

34

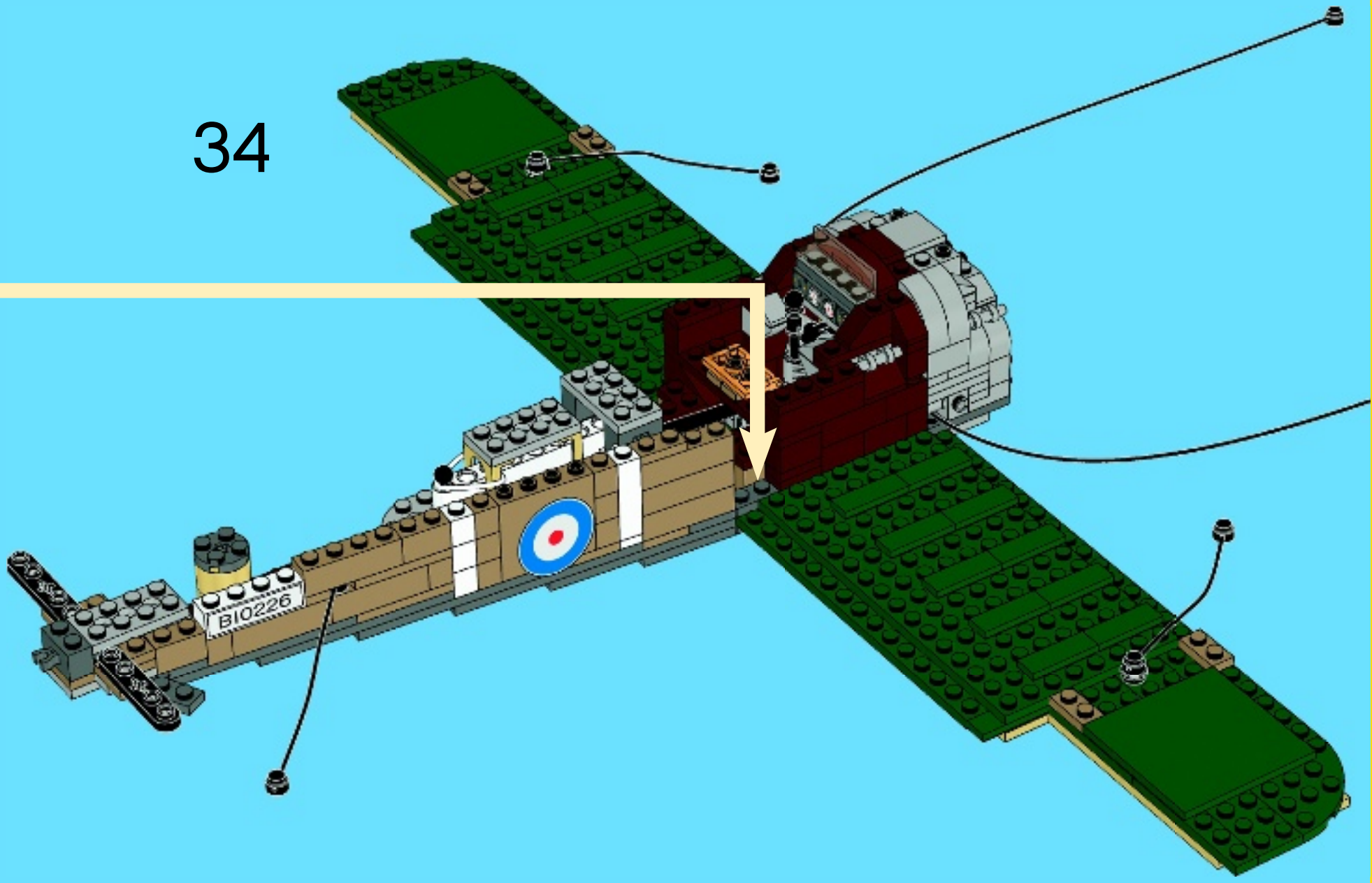

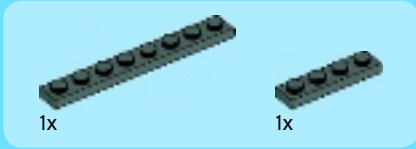
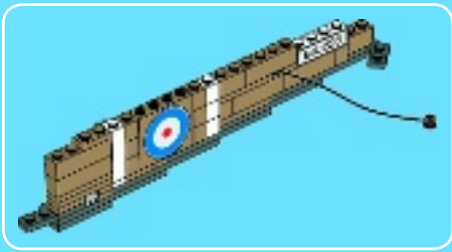

1

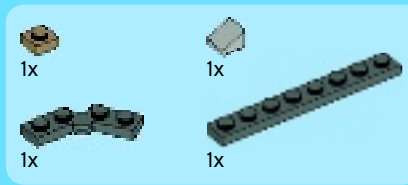
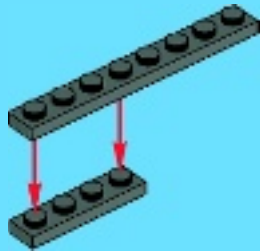

2

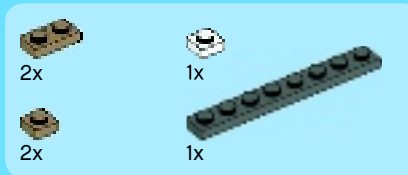
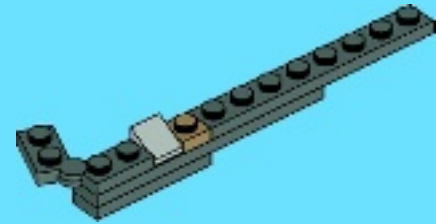

3

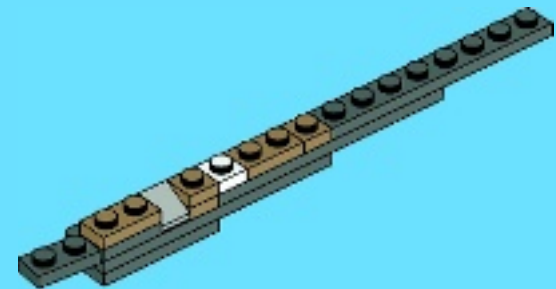

4

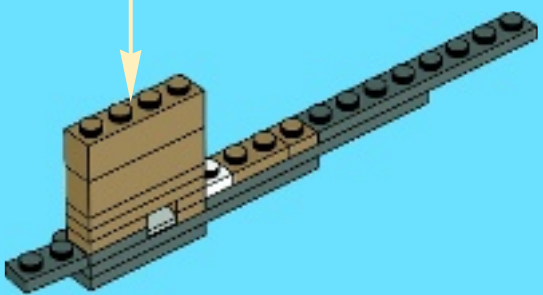
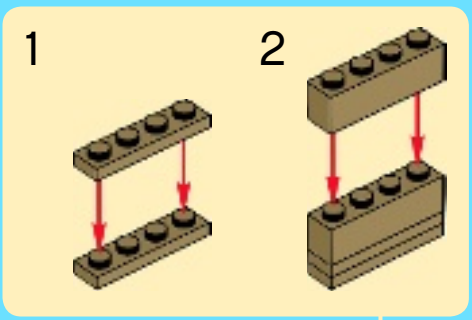
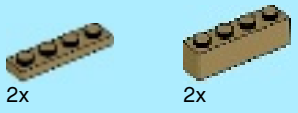

5

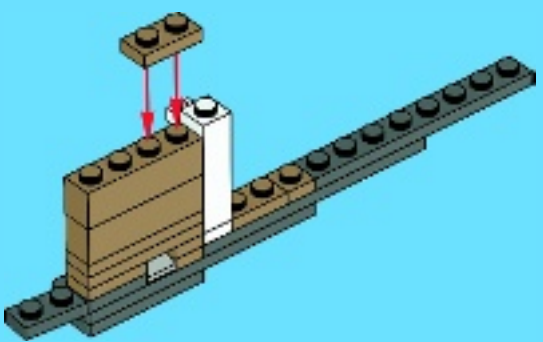
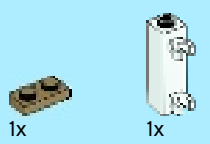

6

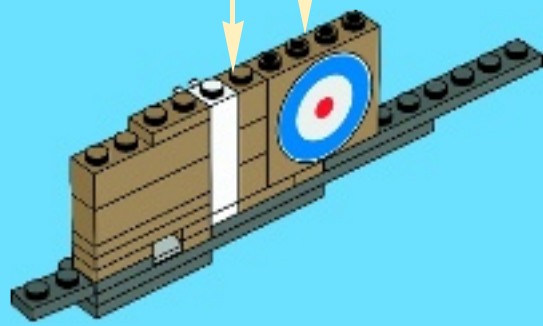
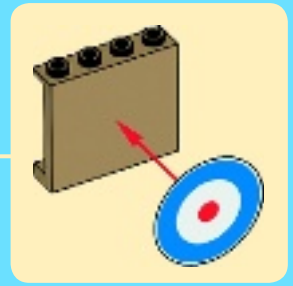
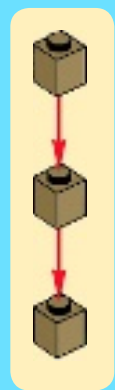
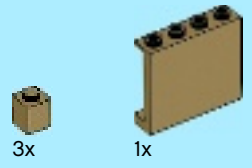





3x



3x

# 7

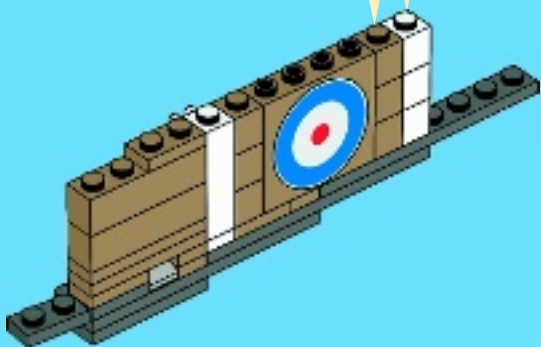
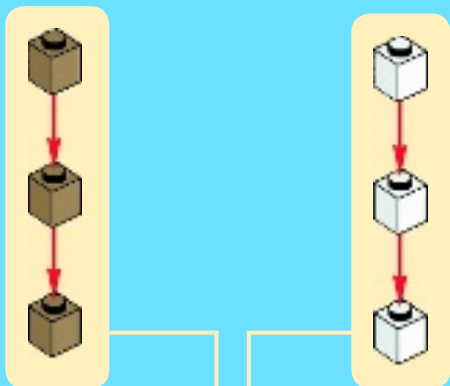

1x



2x



2x



2x

# 8

1

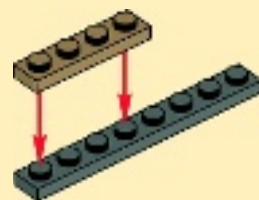

2

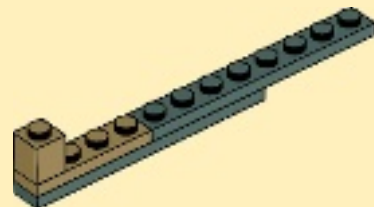

3

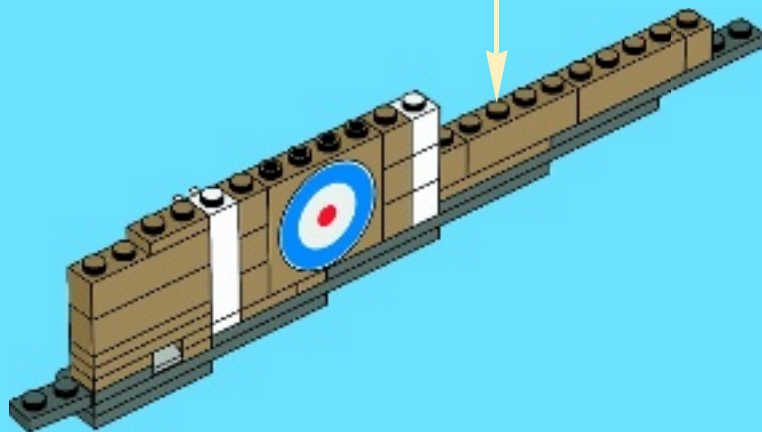
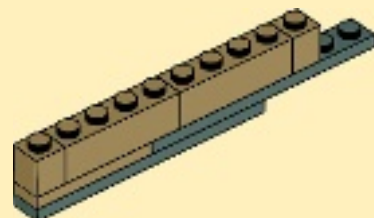

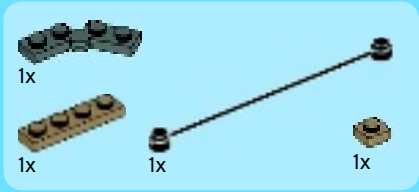

9

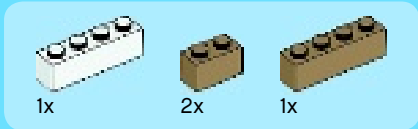
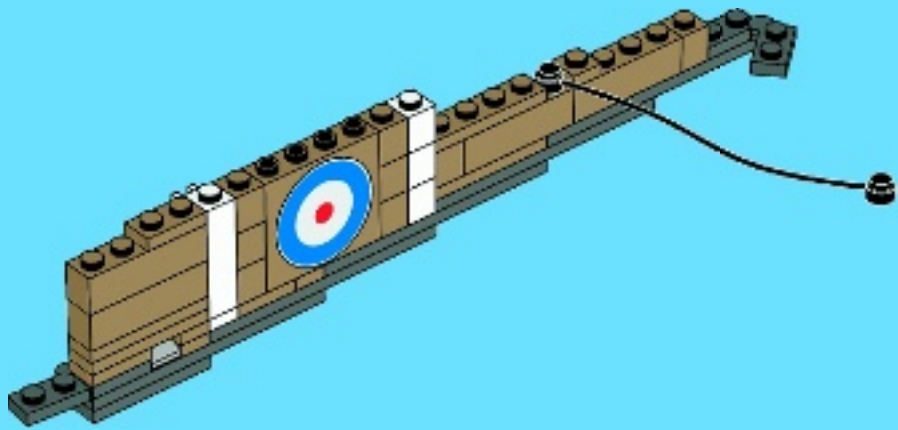

10

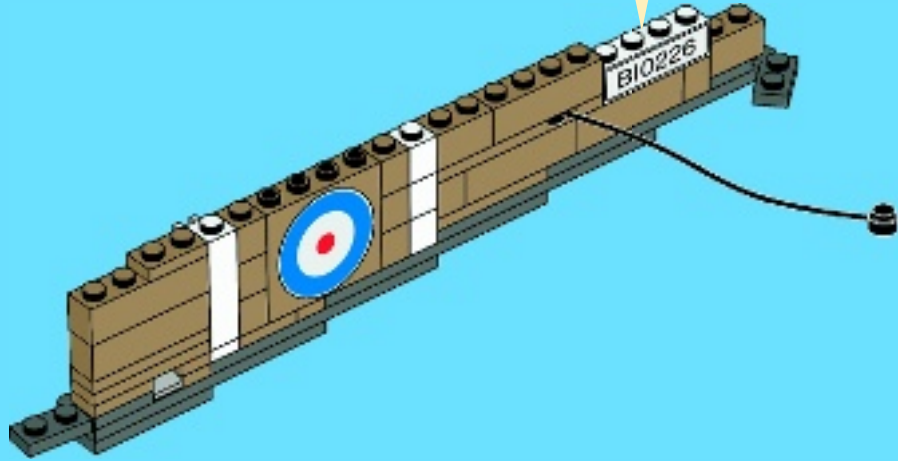
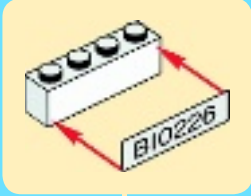

35

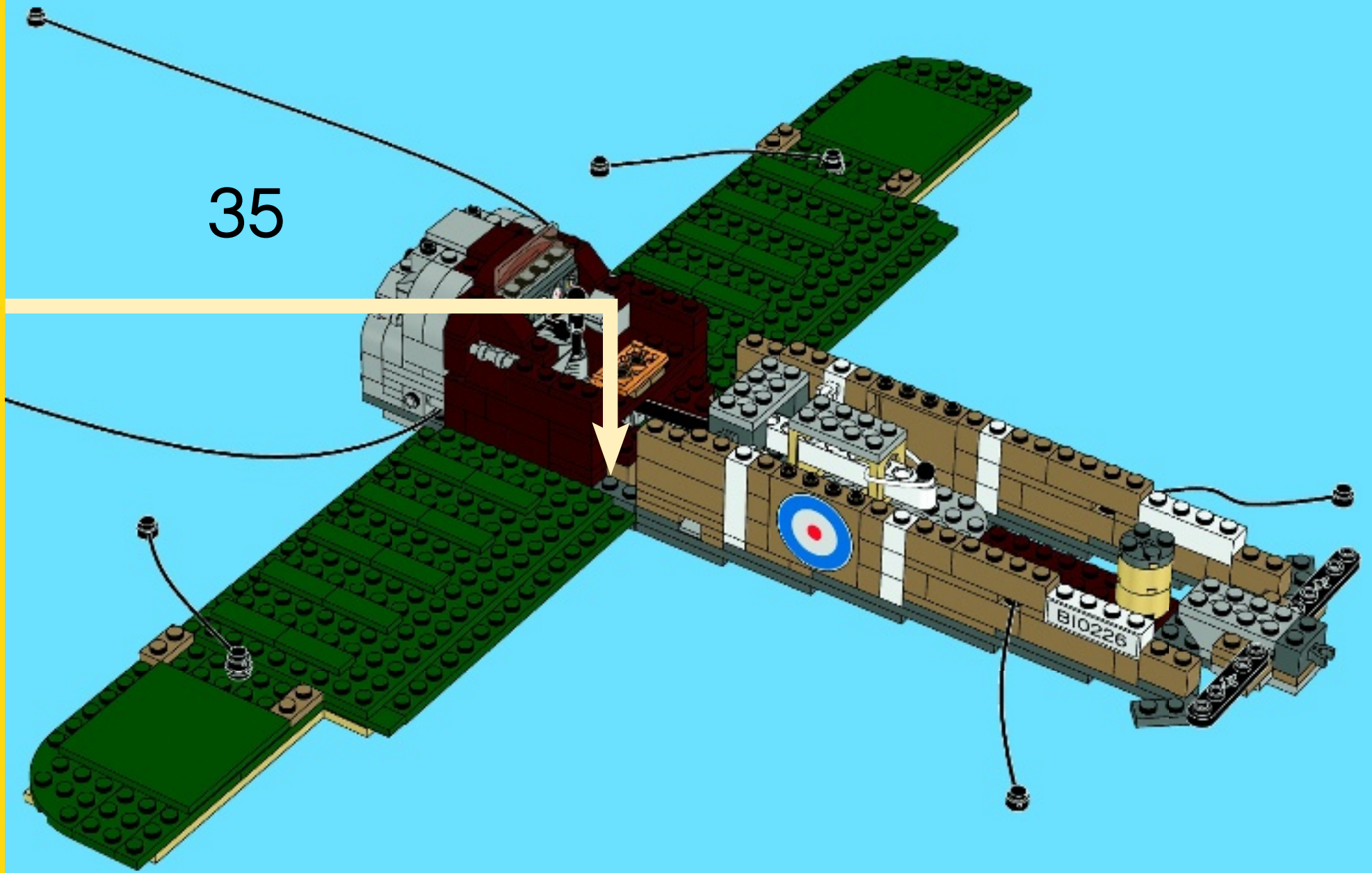



2x



4x

# 36



2x

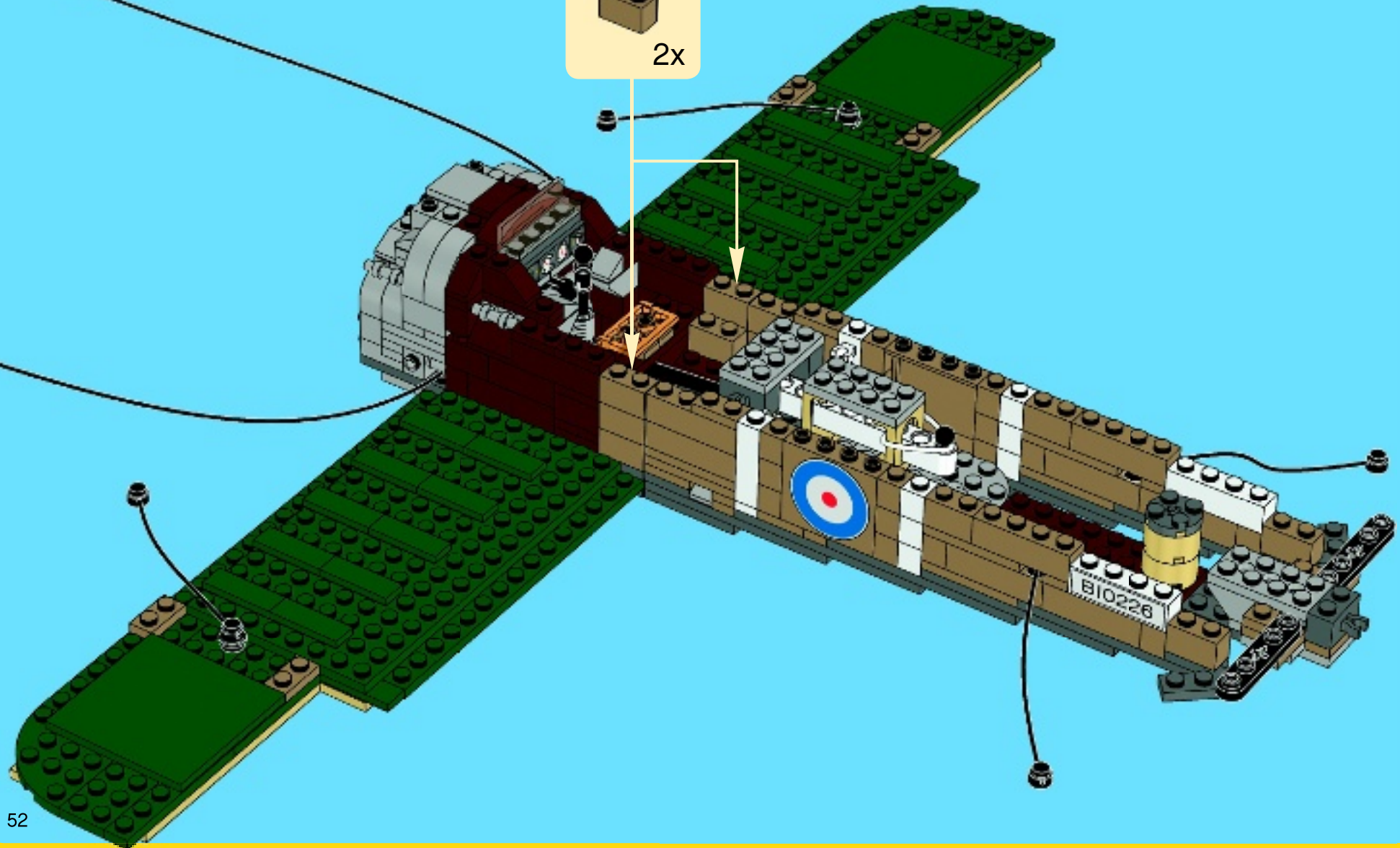



2x



1x

37

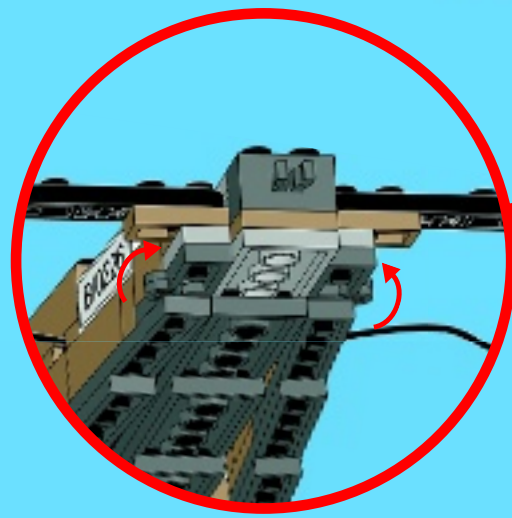
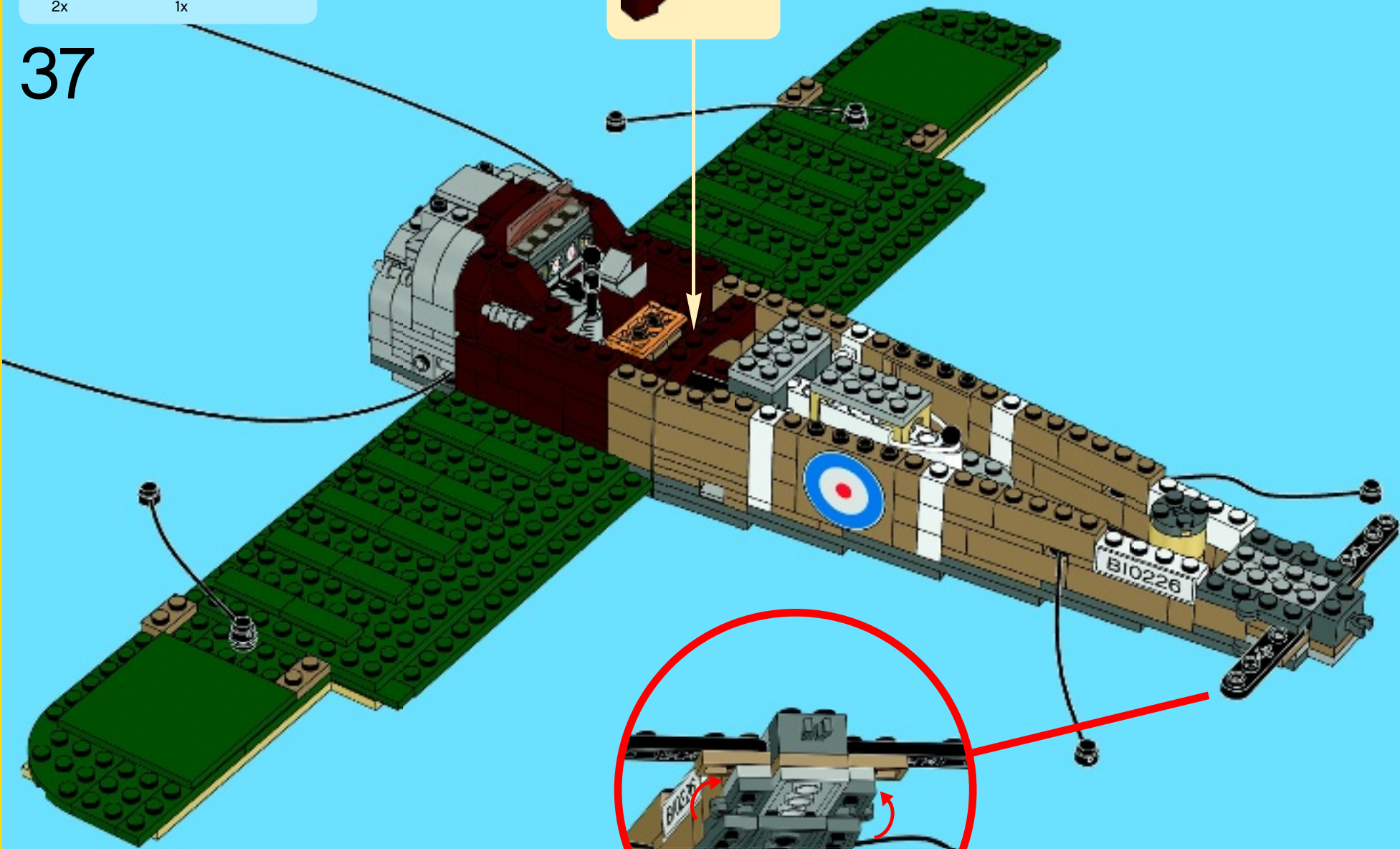
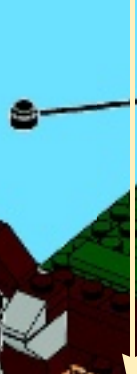

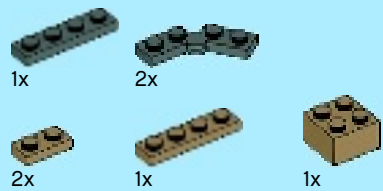

38

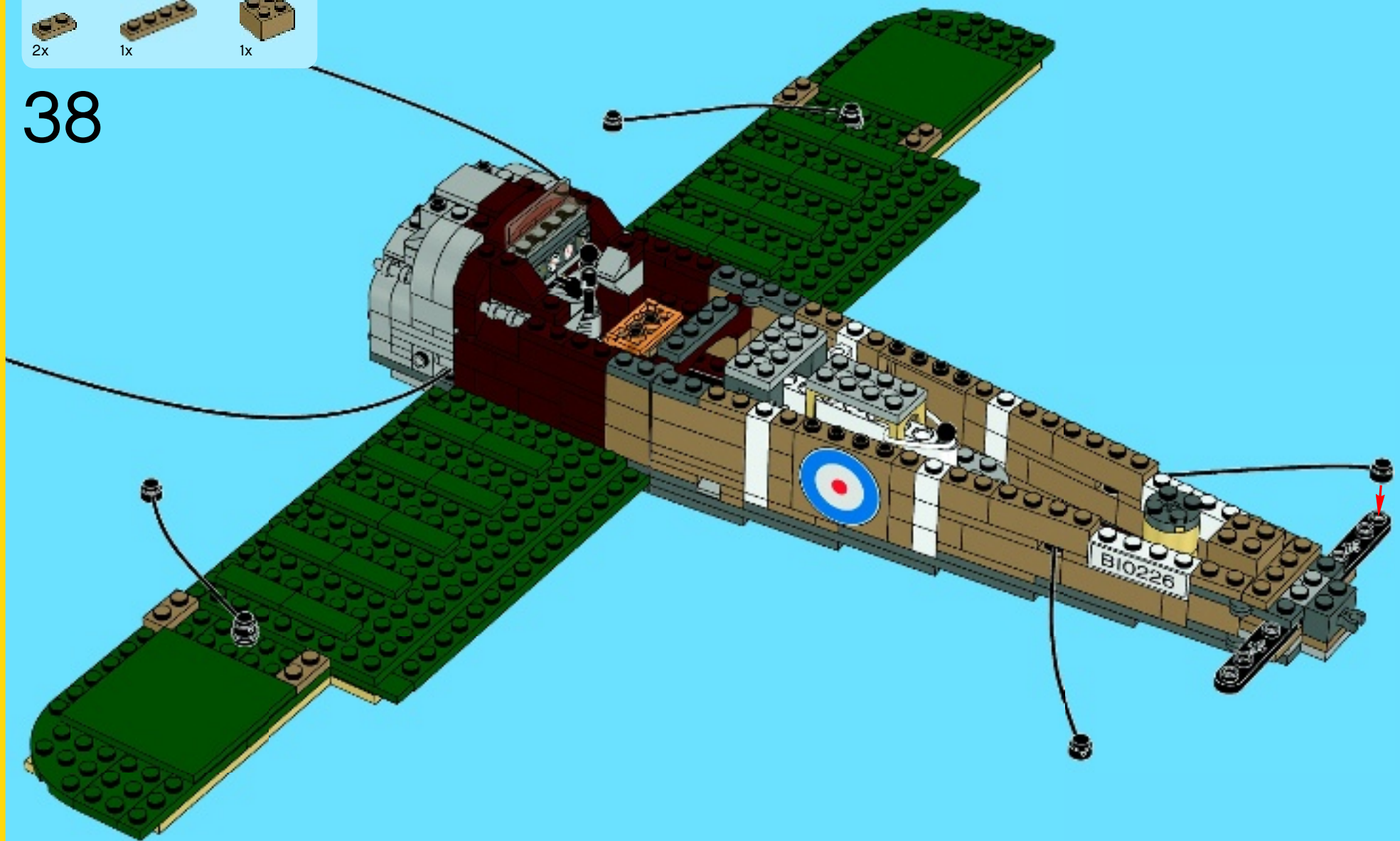

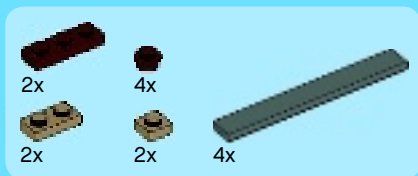

39

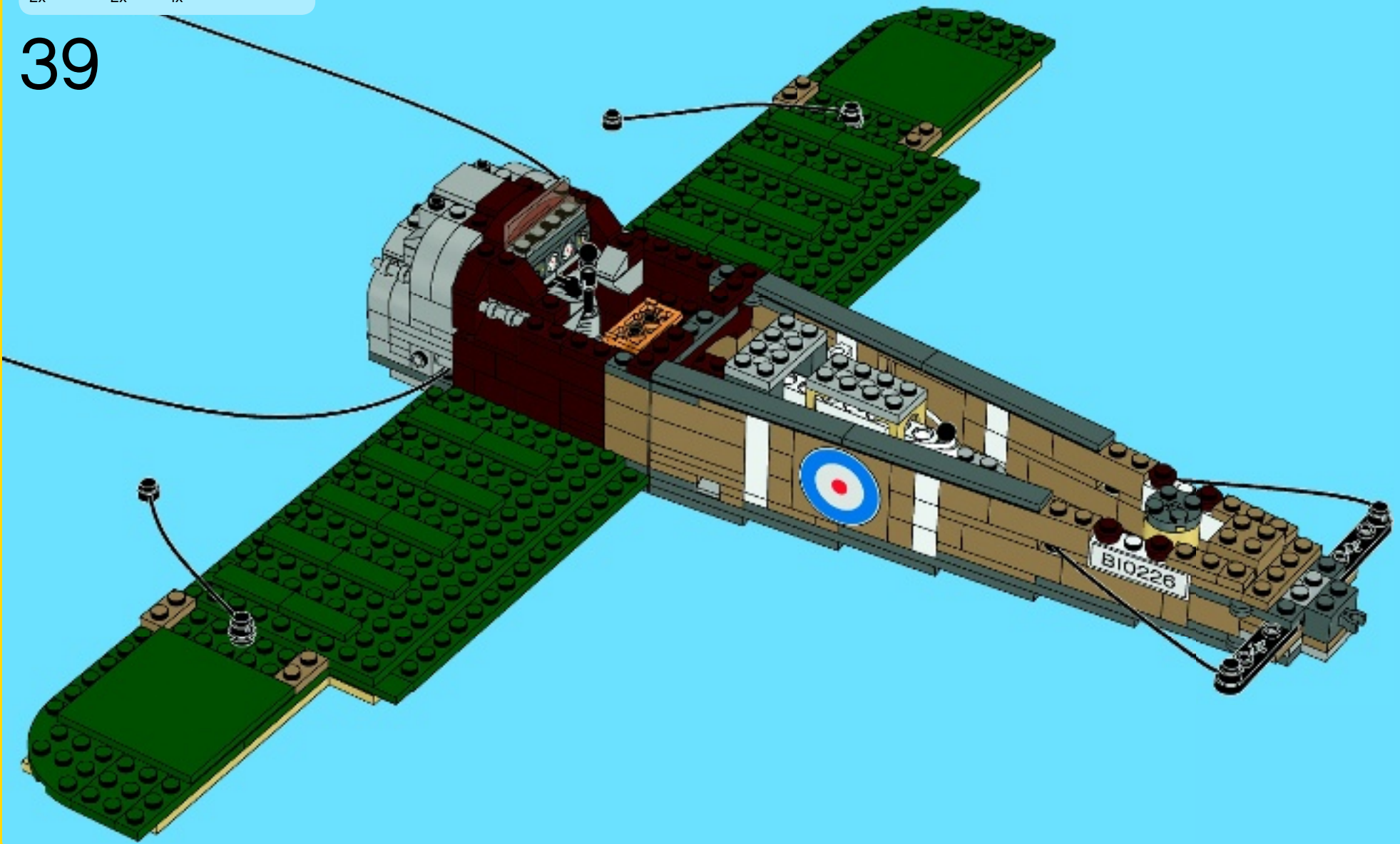

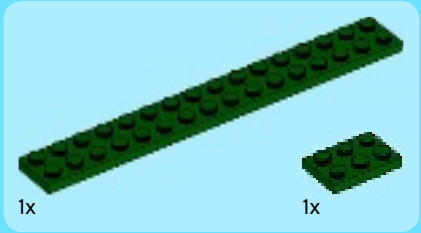
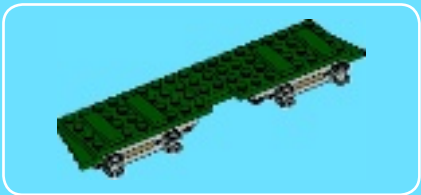

1

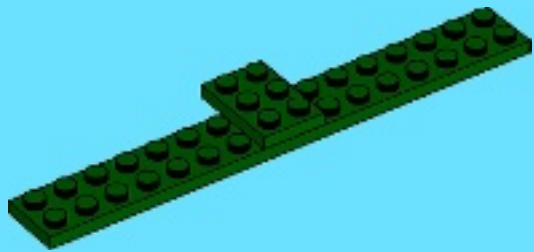

2

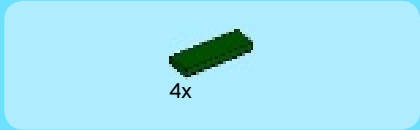
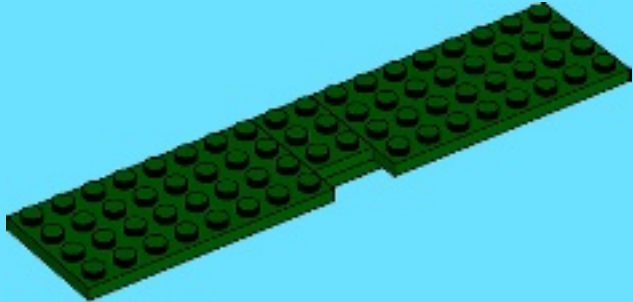

3

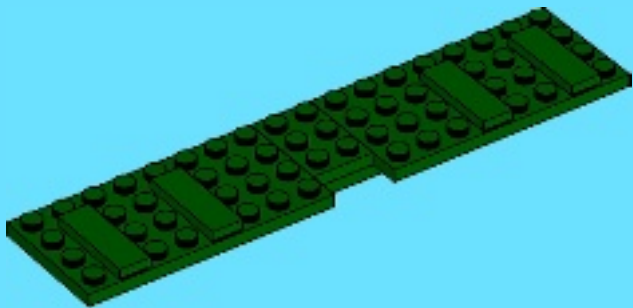



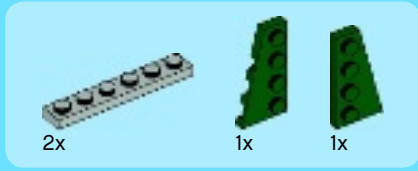

4

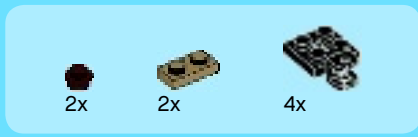
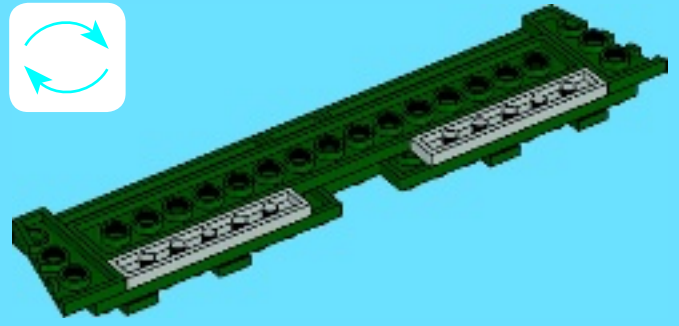

5

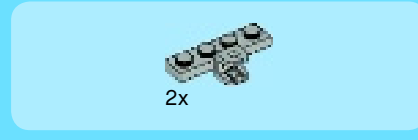
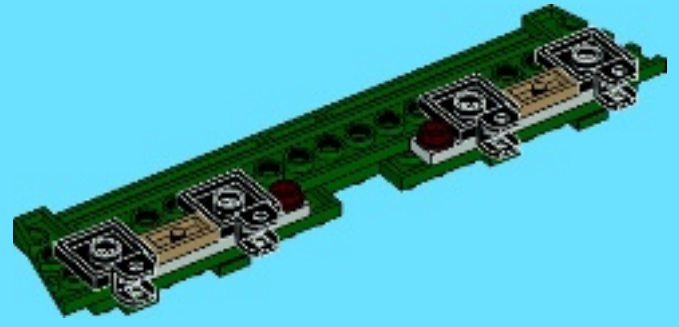

6

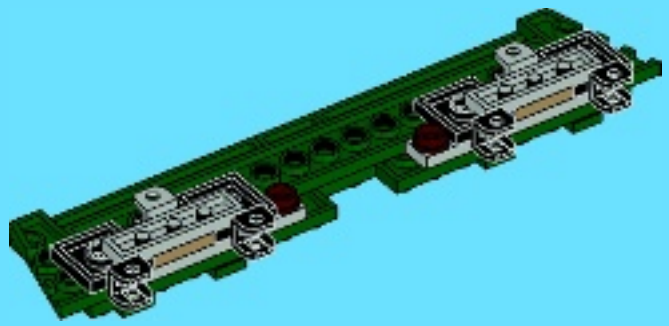

40

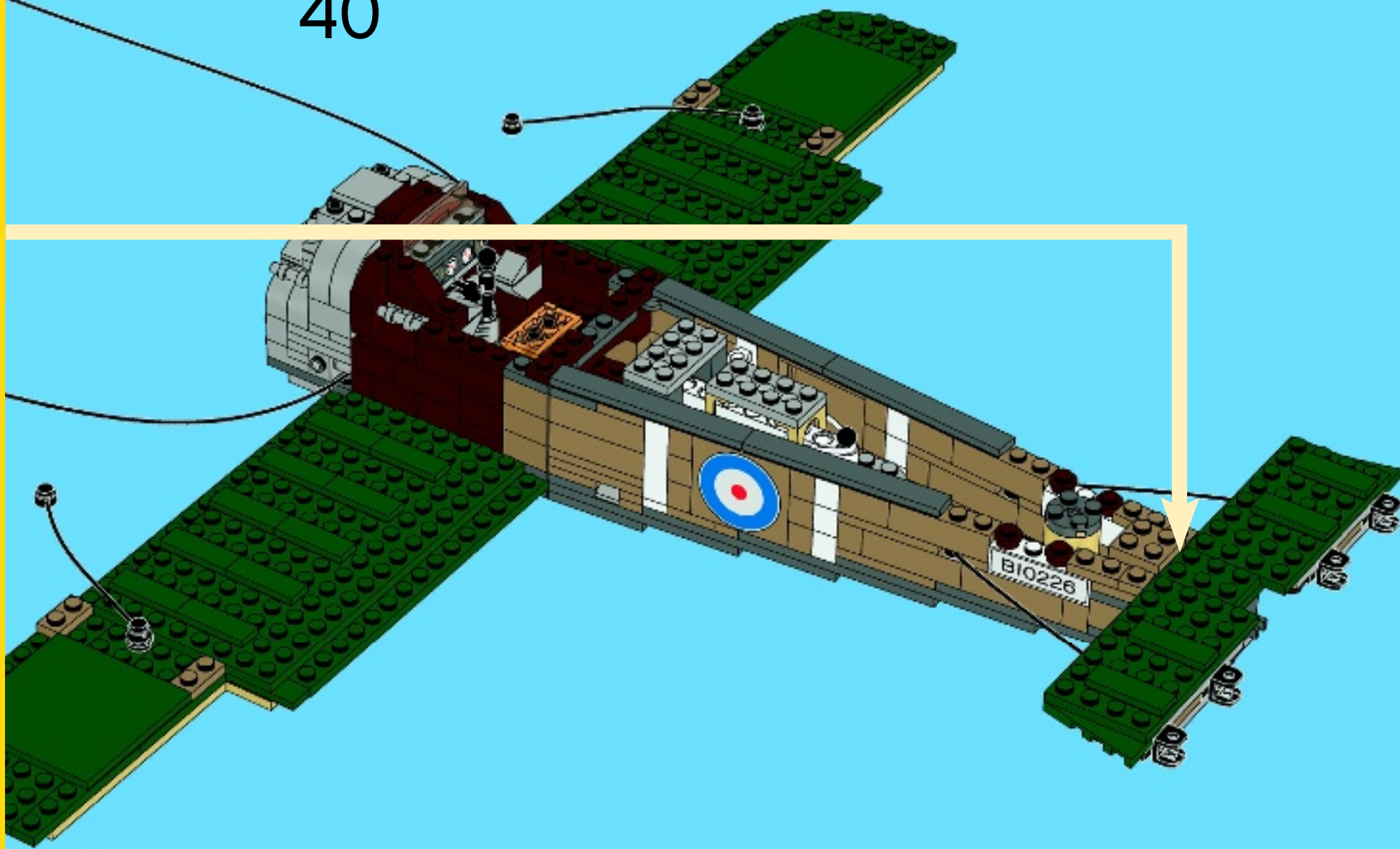

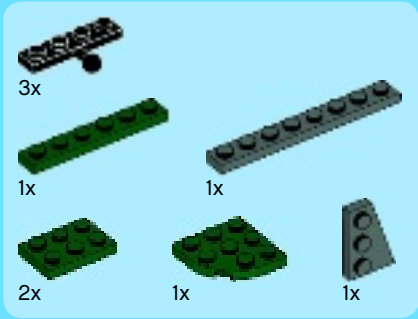

# 41

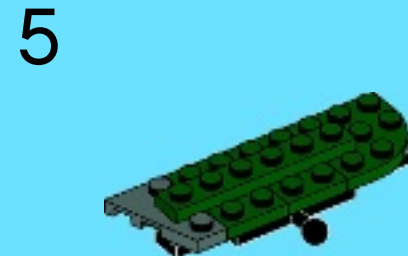
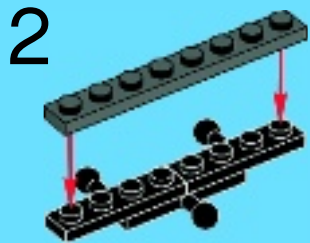
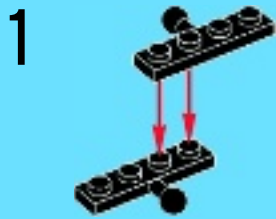

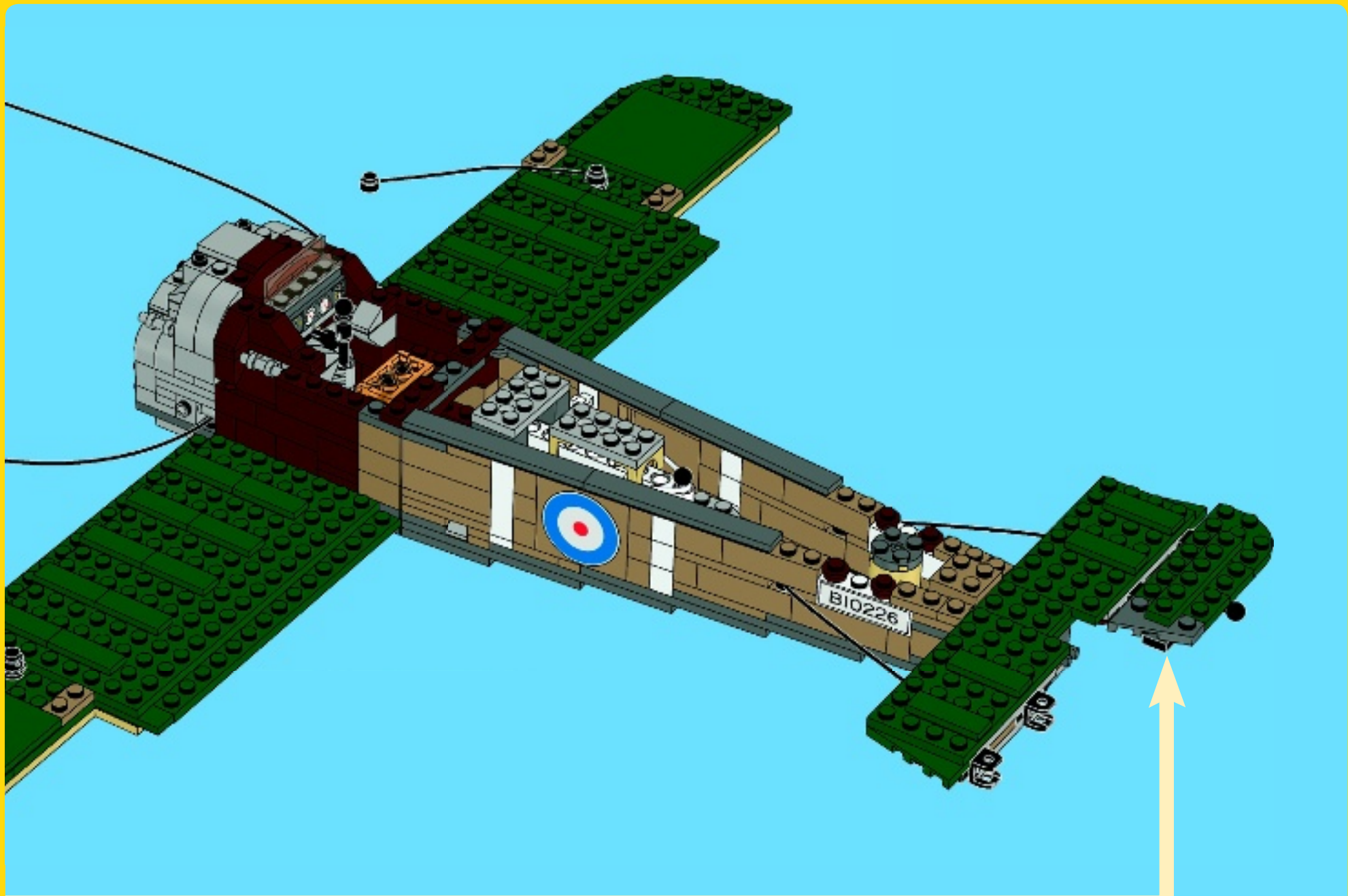

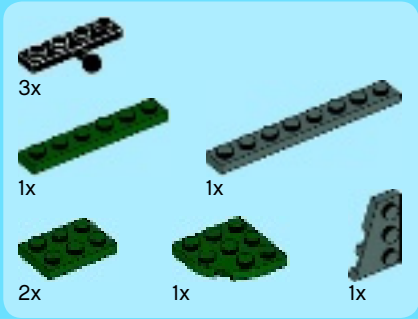

42

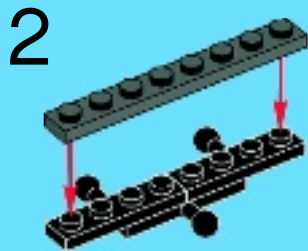
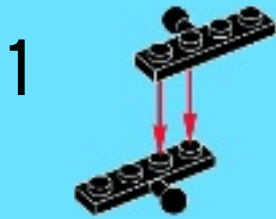

3



4



5



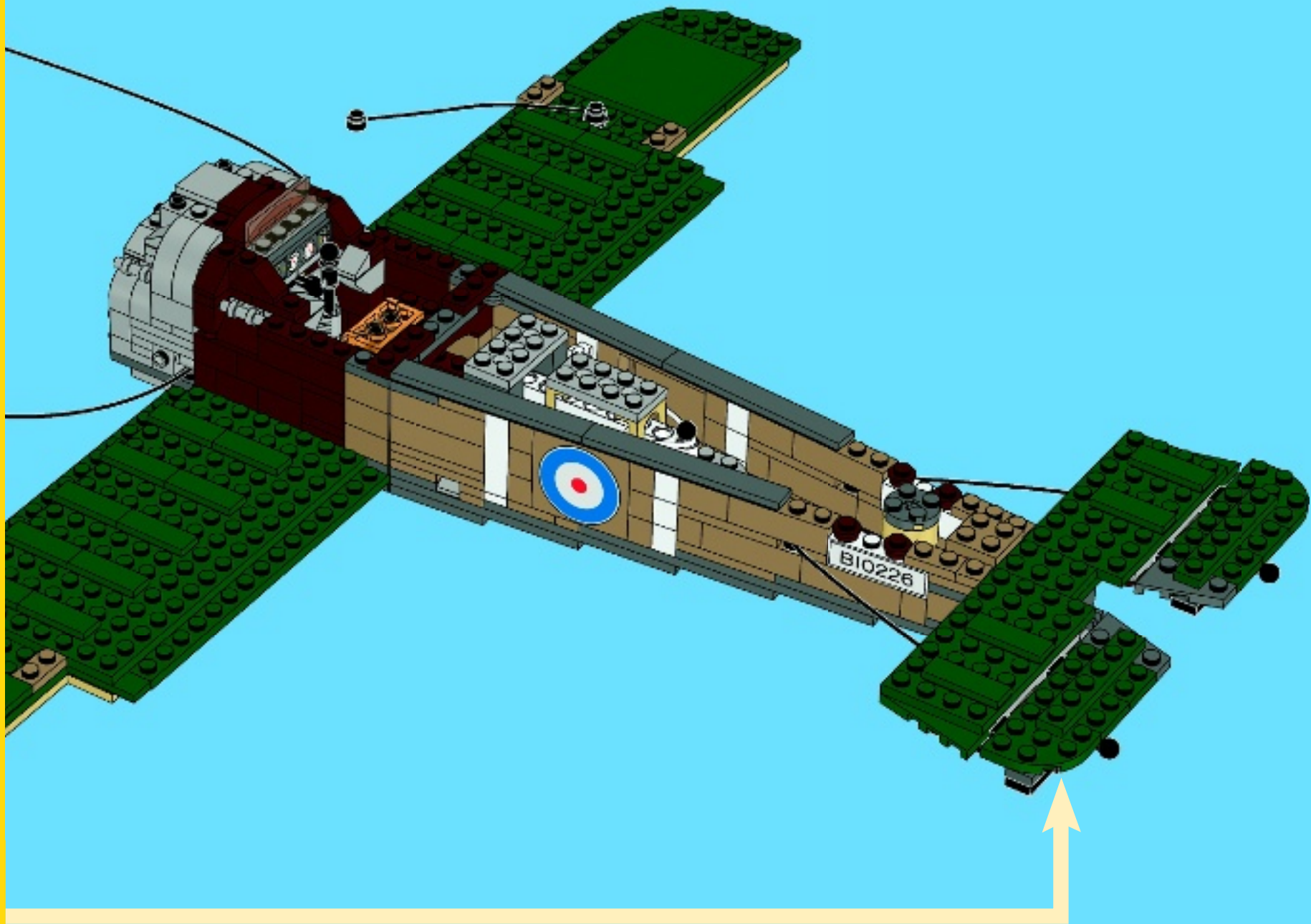



43

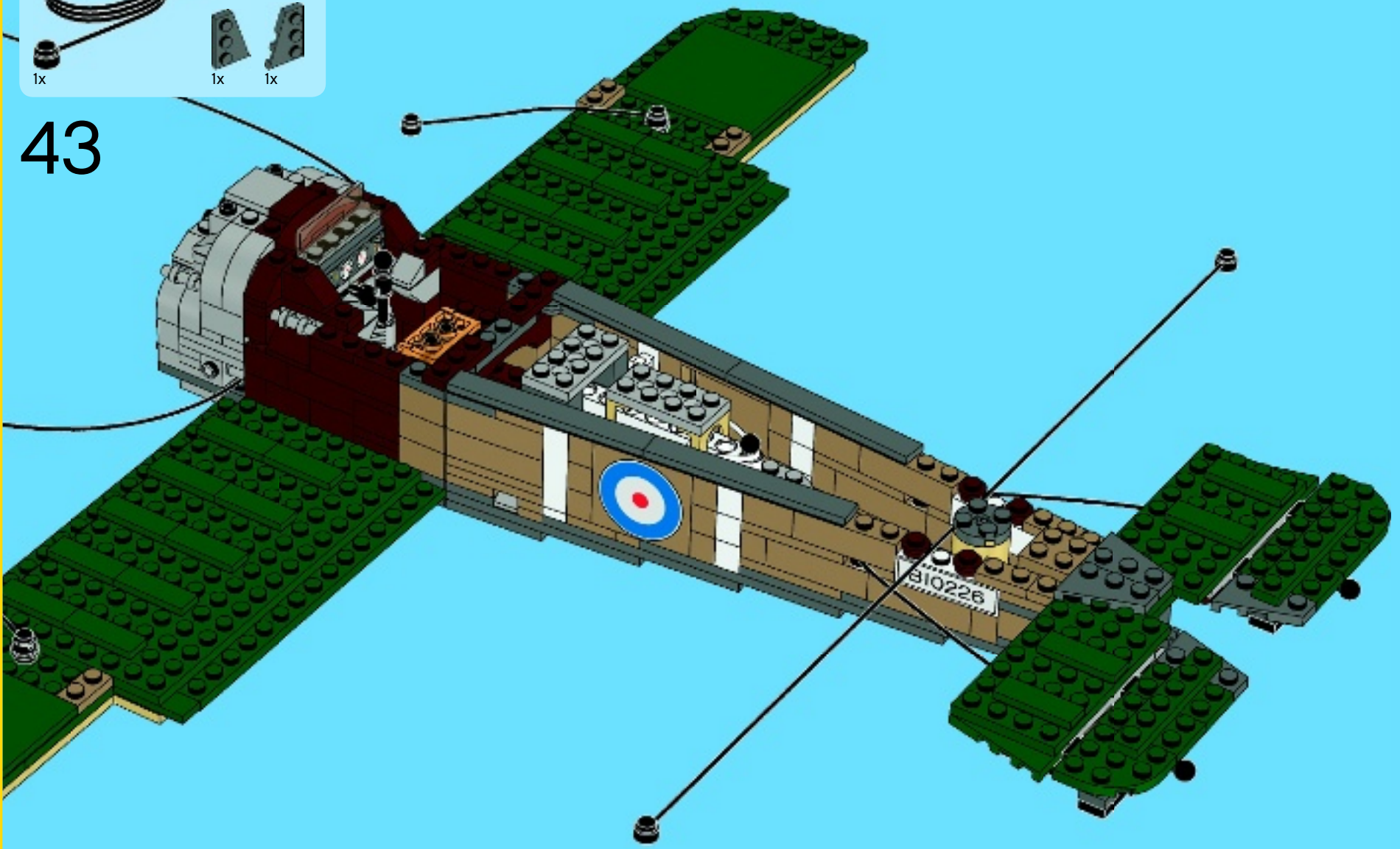



2x



4x

# 44

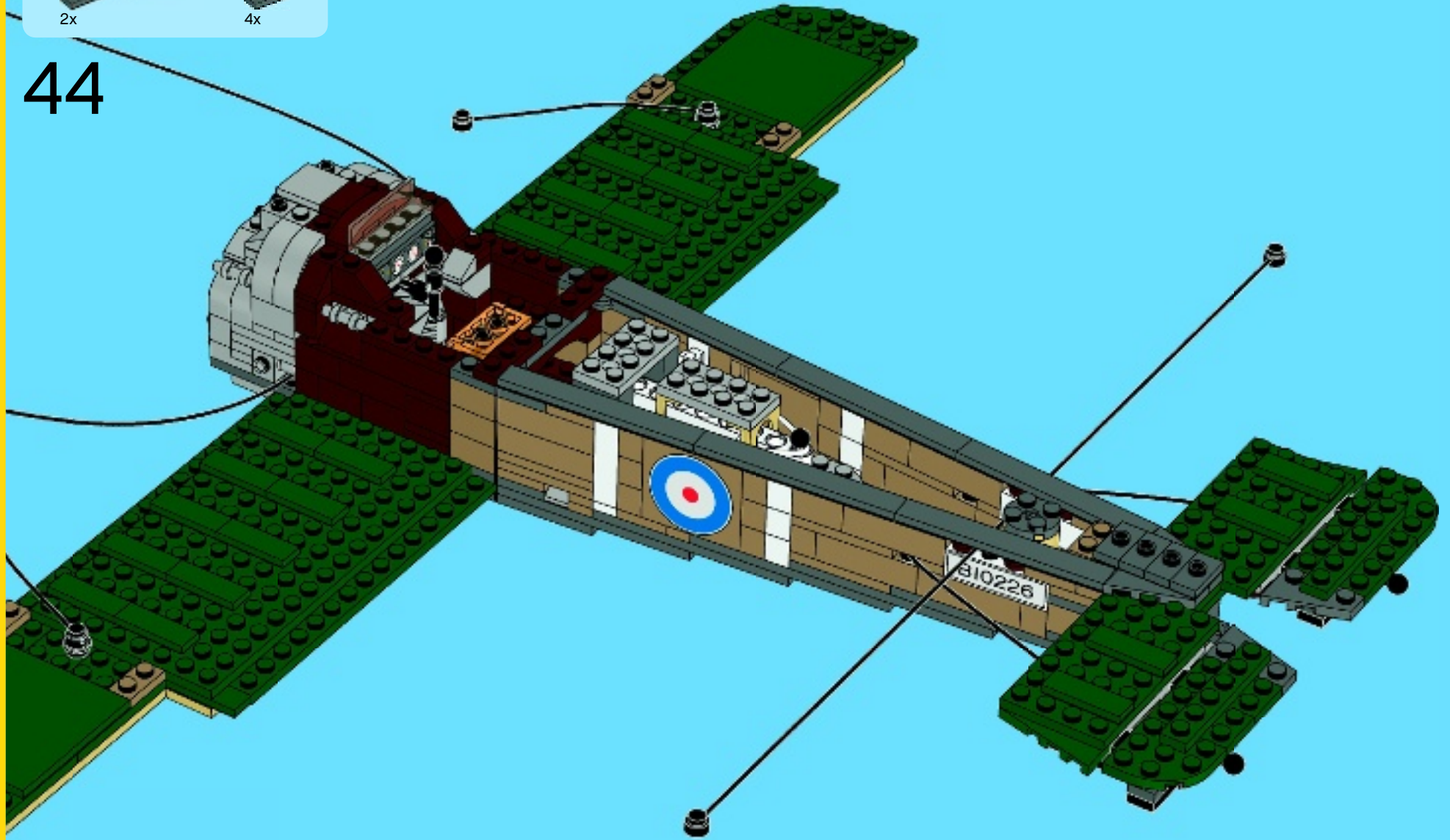



45

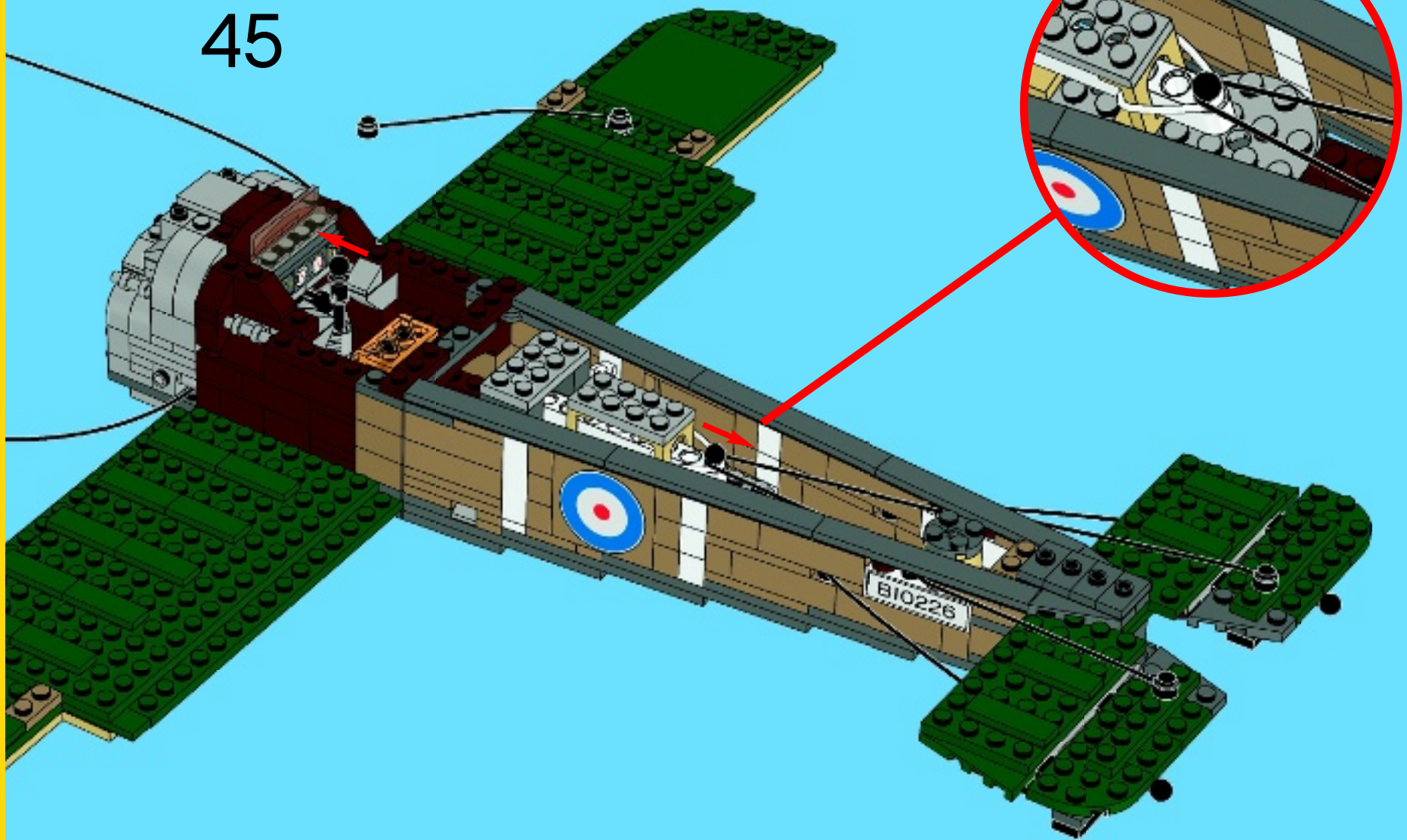

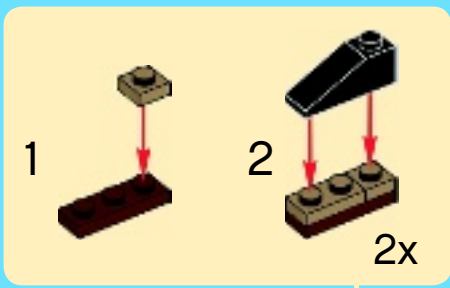
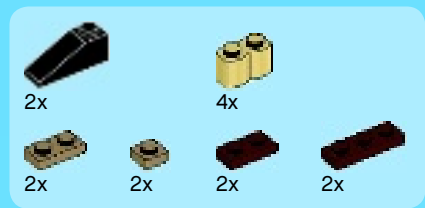

46

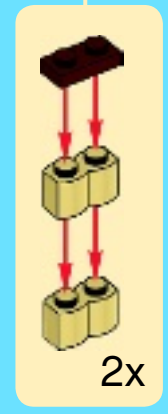
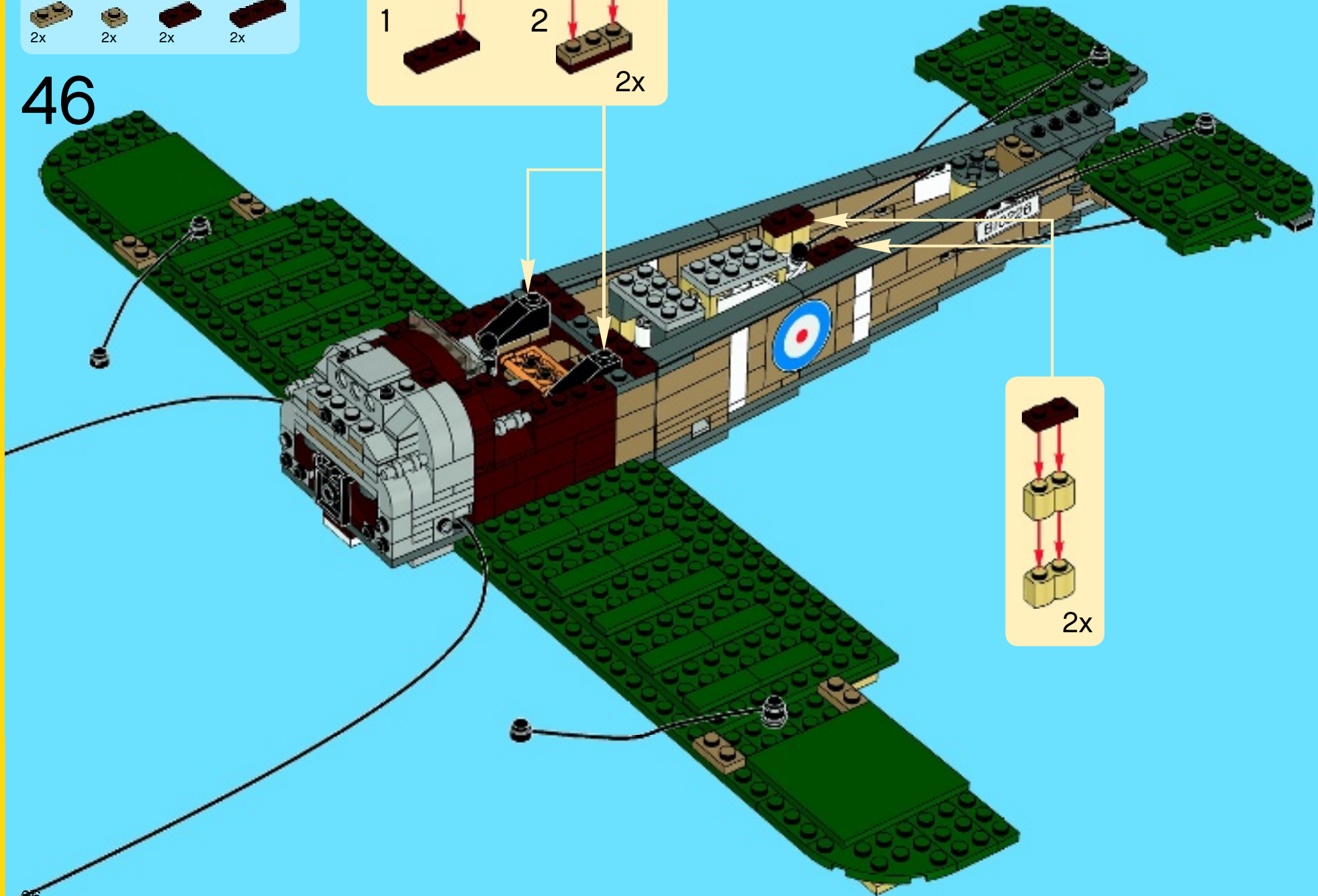

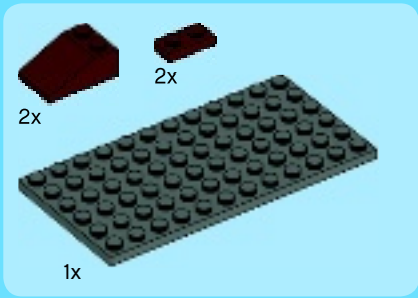
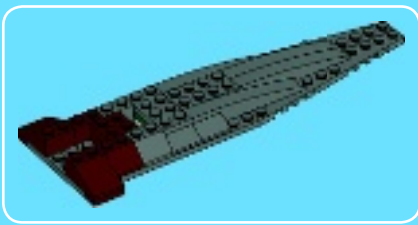

1

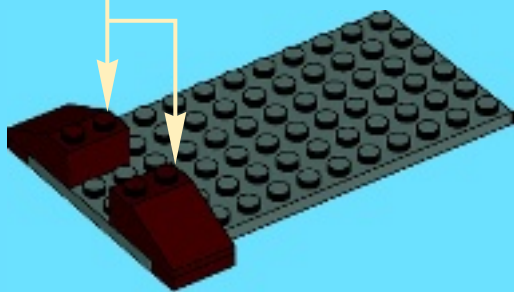
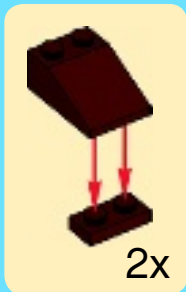

2

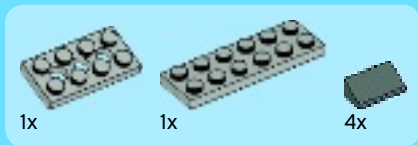
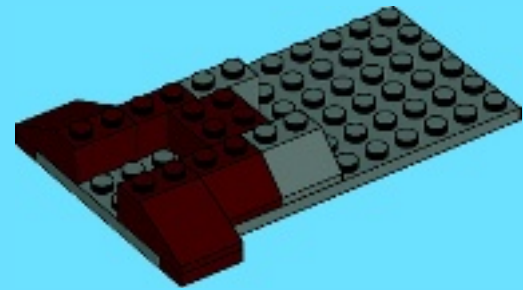

3

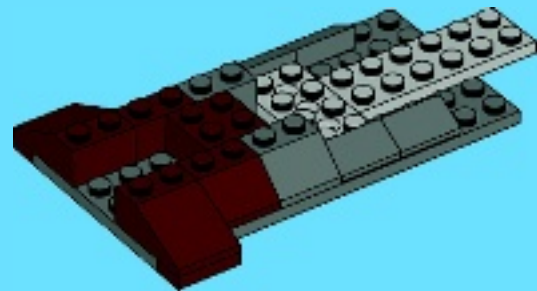

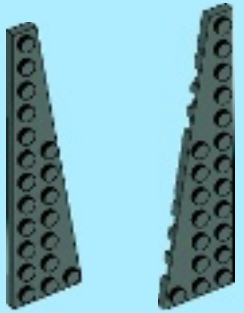

1x

1x

4

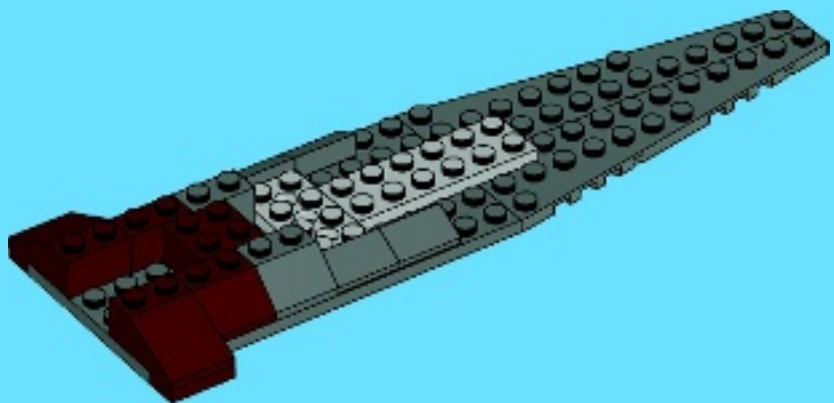

4x



1x

5

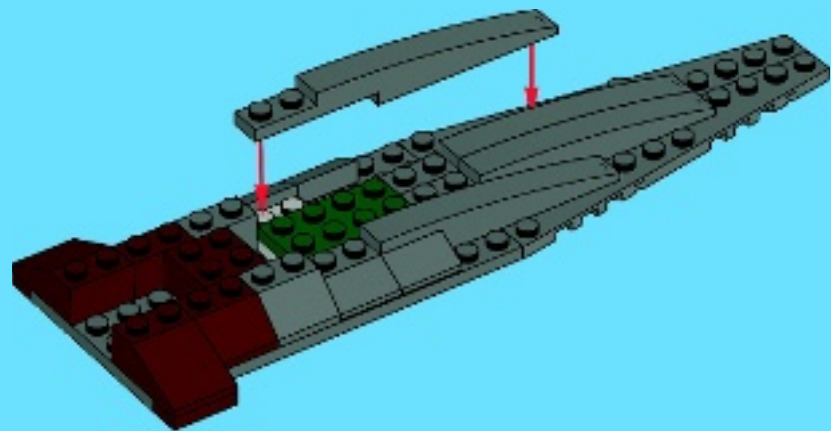

2x

6

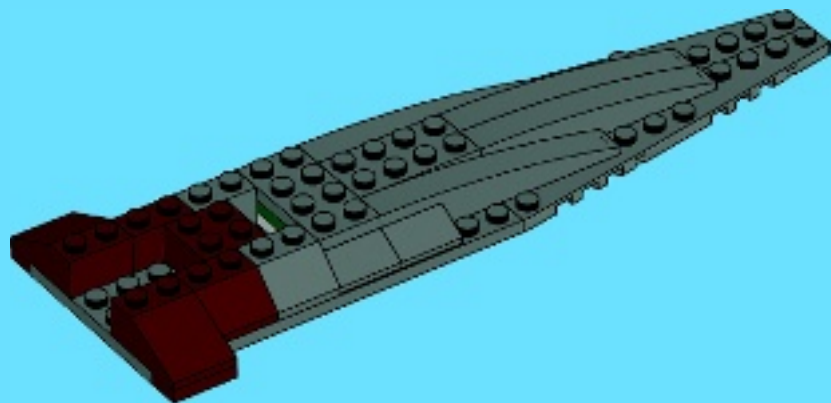

47

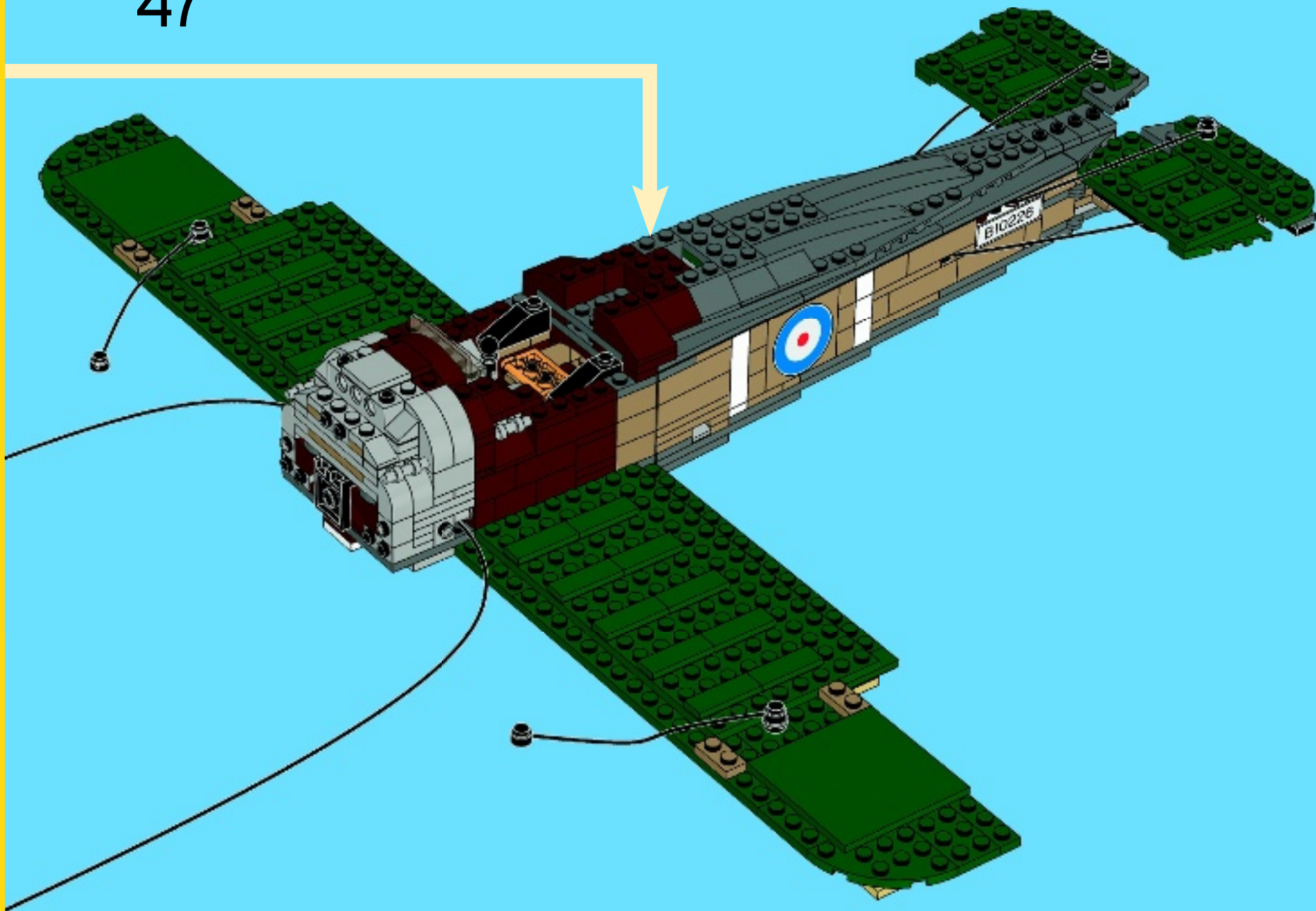

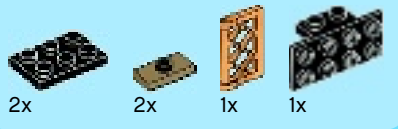

48

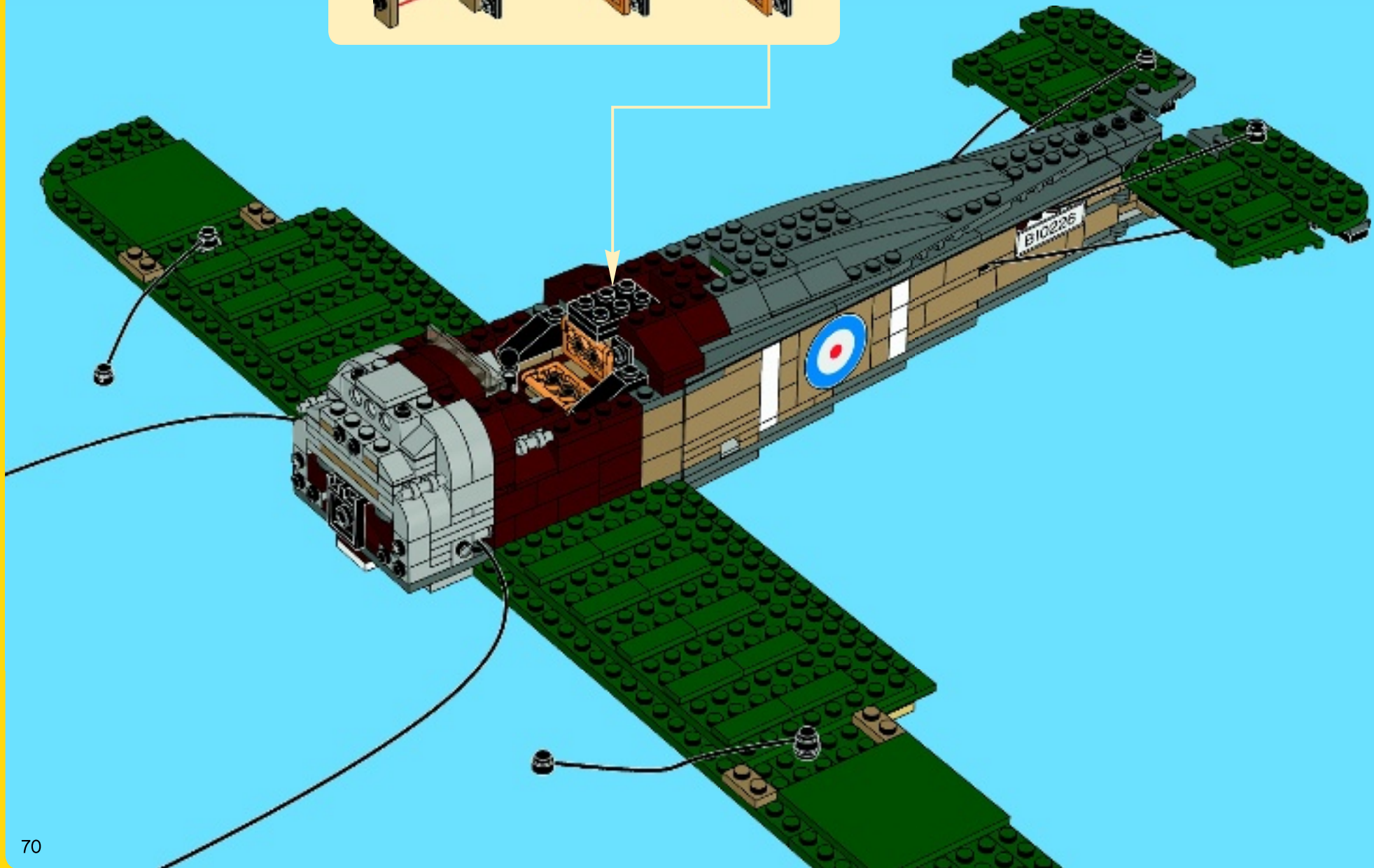
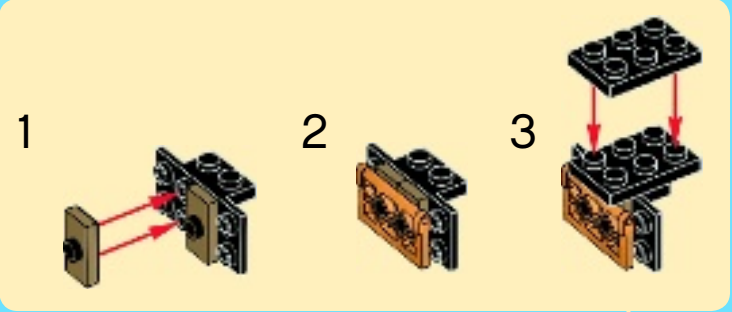

2x  
1x 1x 1x

49

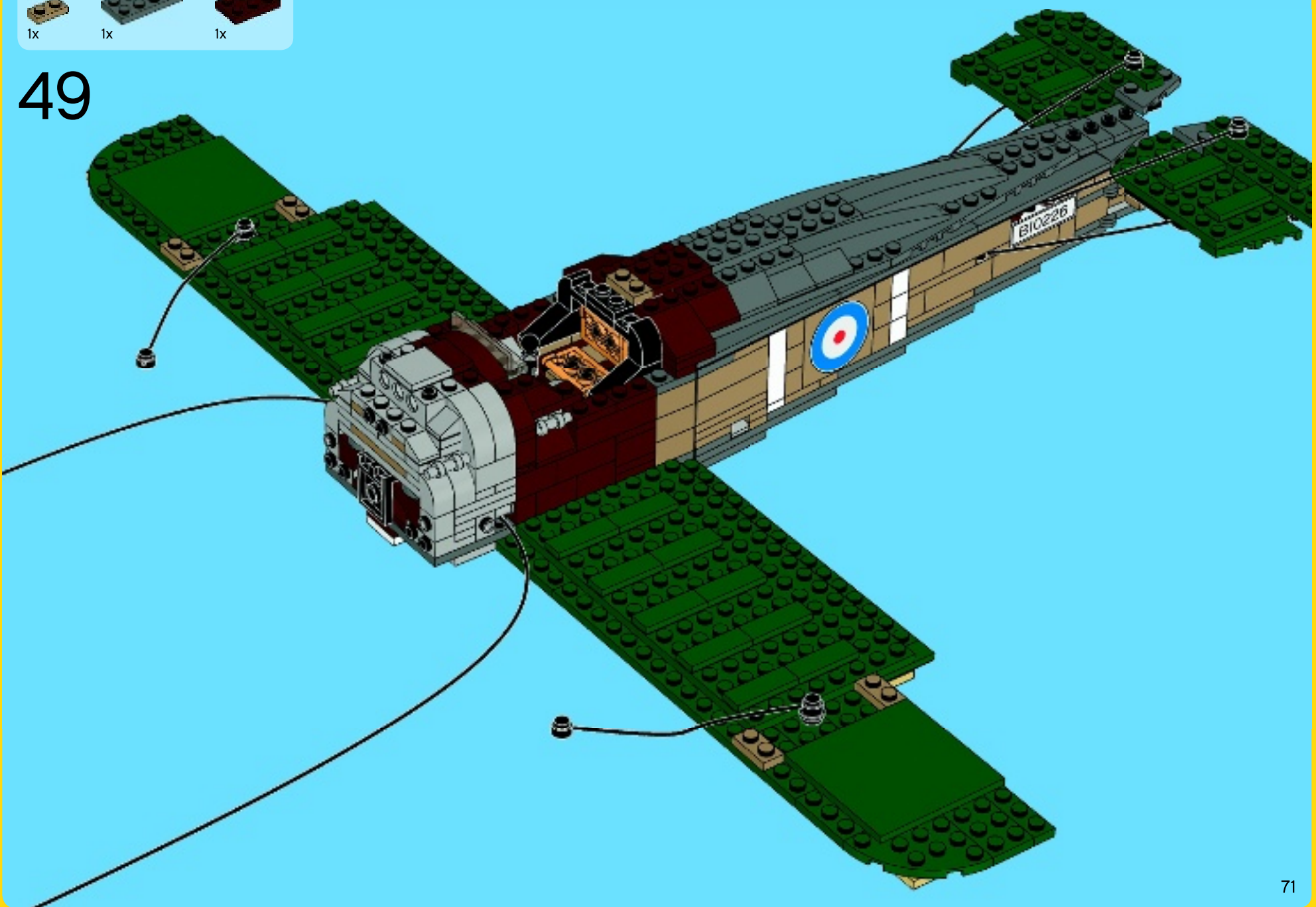



50

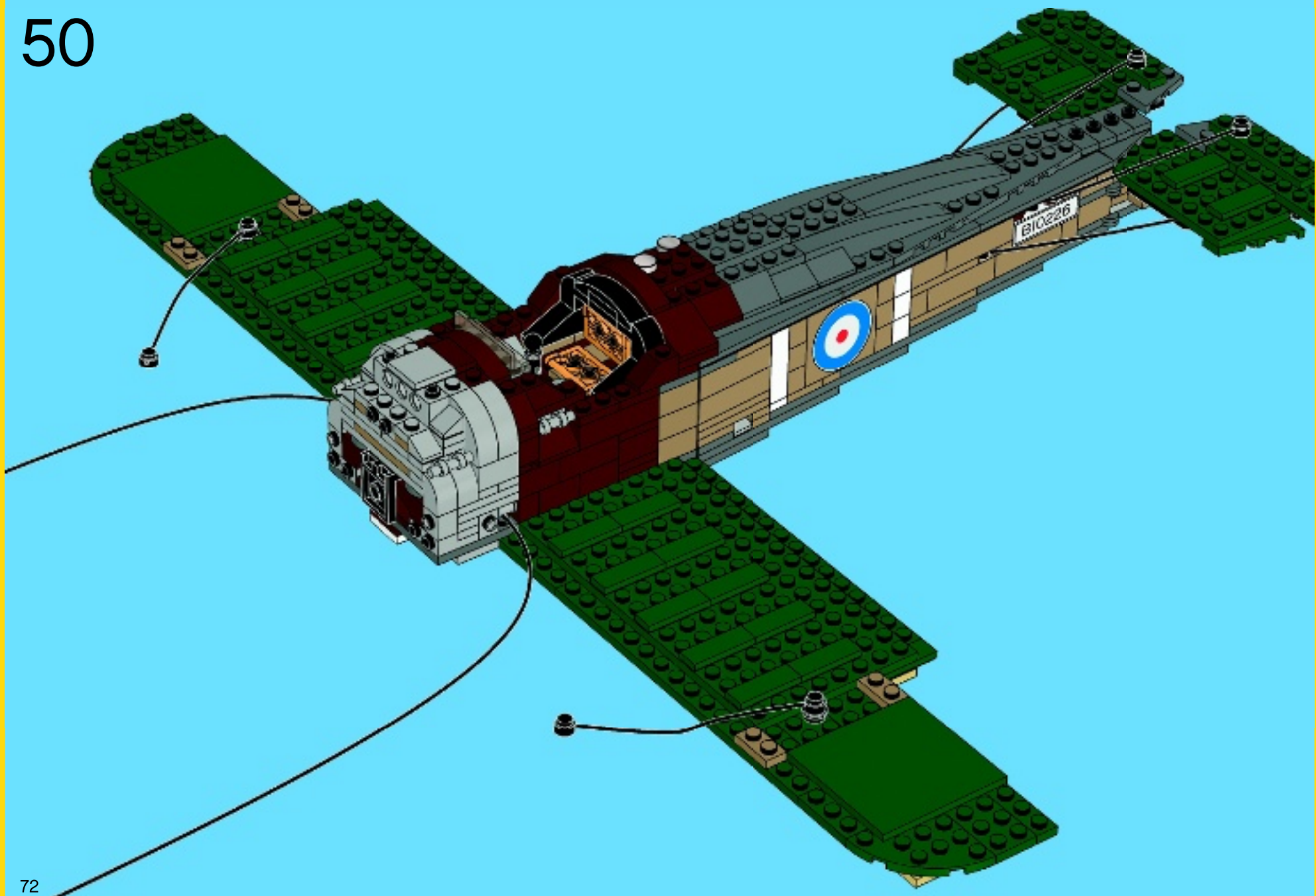



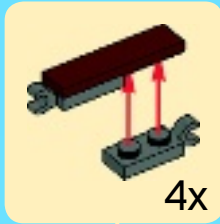

51

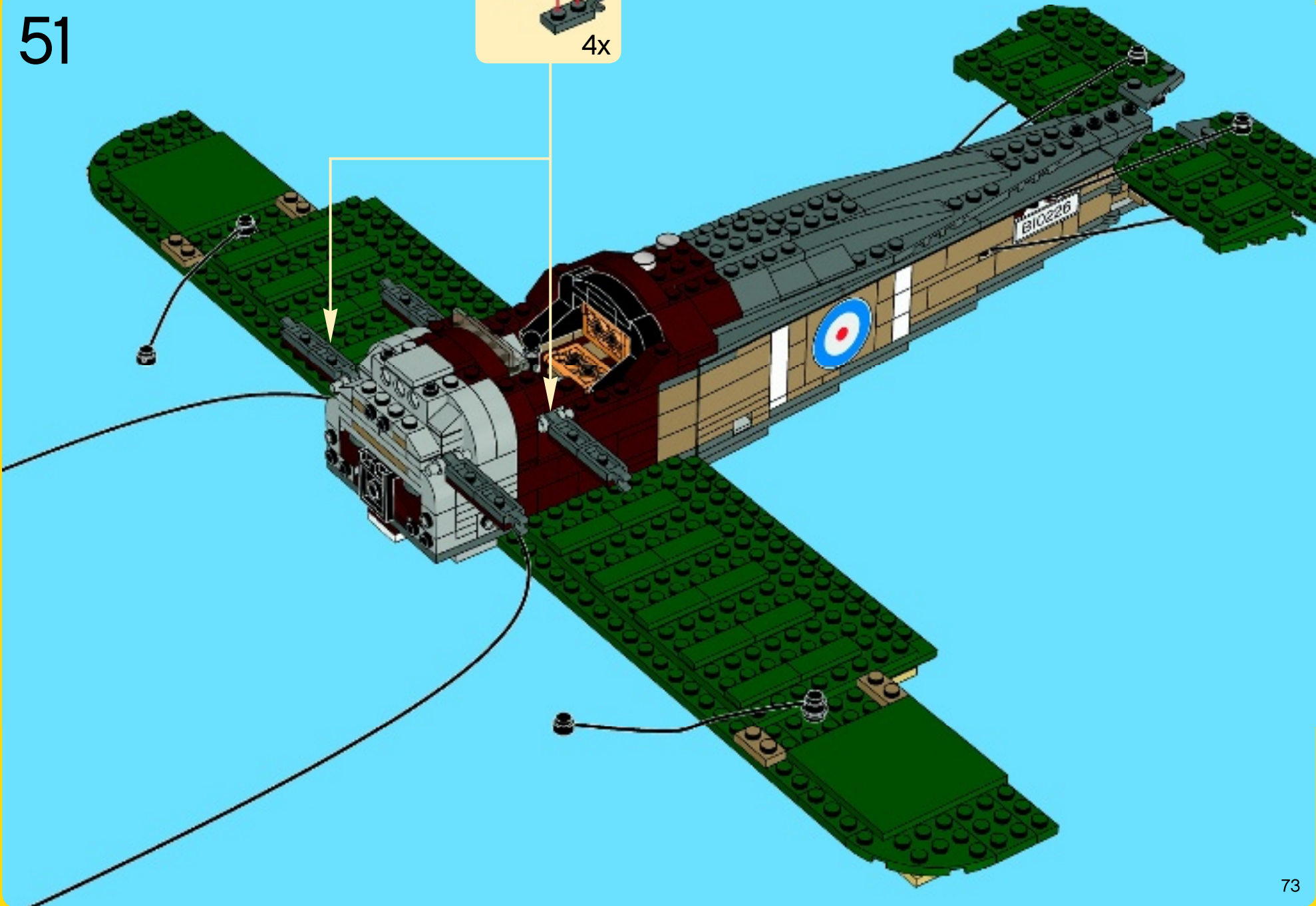

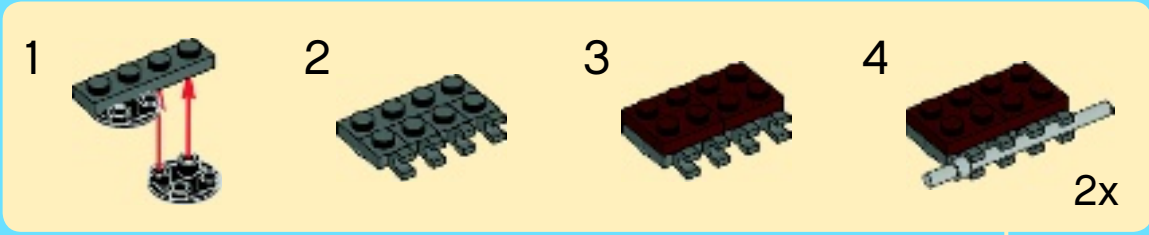
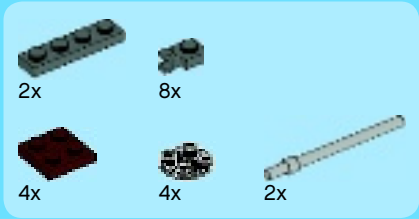

52

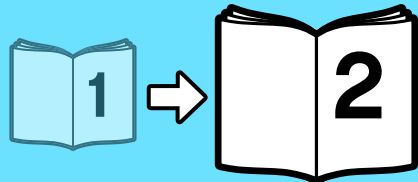
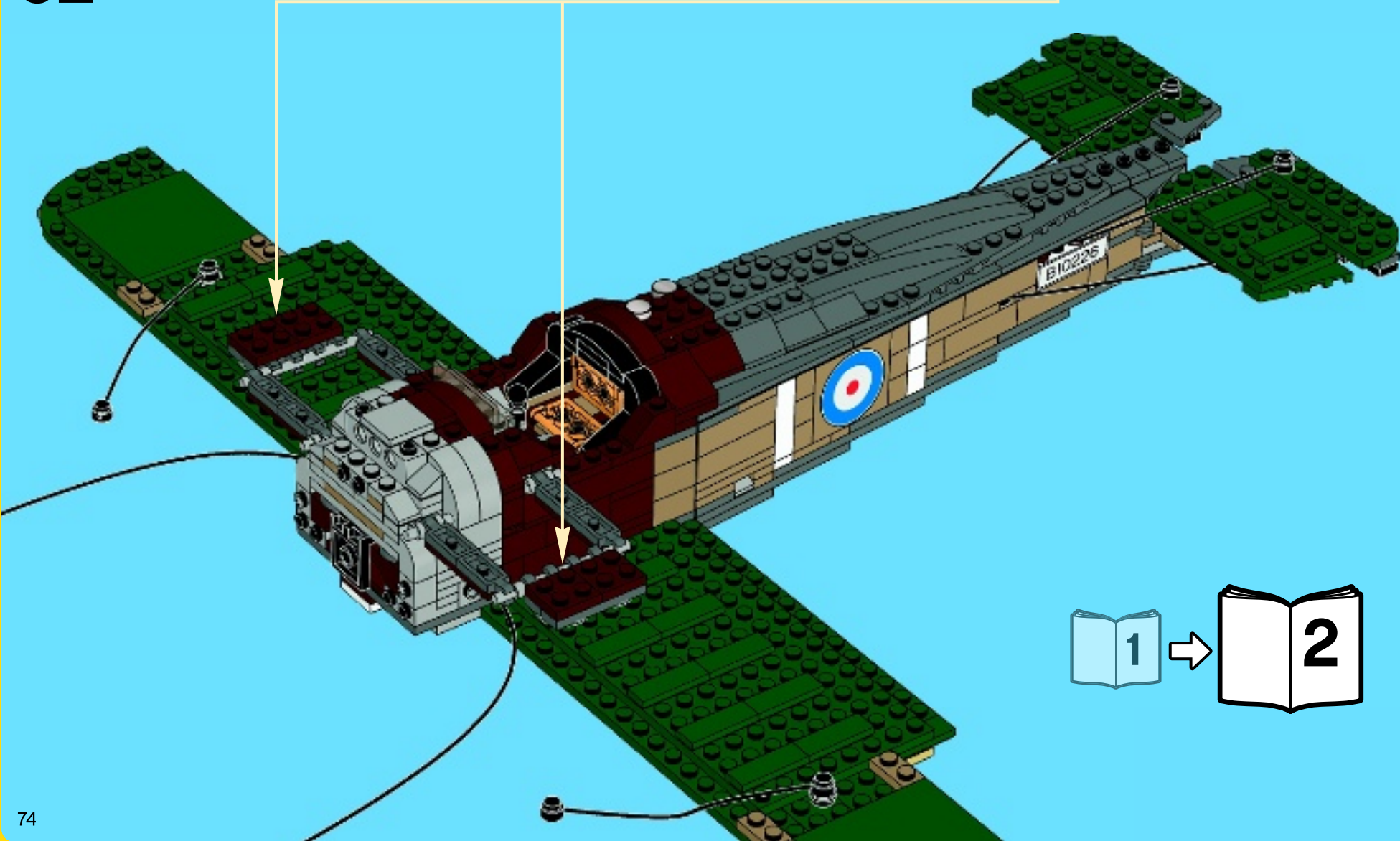



# VIP Program Programme VIP



Earn VIP Points every time you shop directly with us and enjoy valuable rewards

Gagnez des points VIP à chaque achat et profitez de Formidables avantages



Earn 100 VIP Points and get a reward off your next purchase!

Gagnez 100 points VIP et bénéficiez d'une réduction sur votre prochain achat !

Access exclusive LEGO® sets just for VIPs

Accédez aux ensembles LEGO® exclusifs réservés aux membres VIP



# VIP.LEGO.com





**LEGO club**

**FREE! GRATIS! GRATUIT!**

[www.LEGOclub.com](http://www.LEGOclub.com)

**LEGO Club Magazine**

**LEGO Club Email**

**YES!** I want to join the LEGO® Club FREE! **OUI!** Je veux m'abonner au LEGO® Club GRATUITEMENT!

**Ja!** Ich möchte Mitglied im kostenlosen LEGO® Club werden. **Ja!** Ik wil graag GRATIS lid worden van de LEGO® Club.

**Ja!** Jeg ønsker å melde meg inn i LEGO® Club gratis! **Ja!** Jag vill gå med i LEGO® Club GRATIS!

First name · Prénom  
Vorname · Voornaam  
Fornavn · Förnamn

Last name · Nom de famille  
Name · Achternaam  
Etternavn · Efternamn

Date of Birth · Date de naissance  
Geburtsdag · Geboortedatum  
Fødselsdato · Födelsedatum

Street · Adresse  
Straße, Hausnr.  
Straat, huisnr.  
Adress

City · Ville  
Ort · Woonplaats  
Poststed · Postort

Zip/Postcode · Code  
Postal · PLZ · Postcode · Postnummer

Email · Courriel · E-Mail · E-post

- Fill in your email address and we will send you a membership confirmation and monthly email newsletters. If you do not wish to receive the newsletters please tick here. Remplis ton adresse e-mail et nous t'enversons une confirmation d'adhésion ainsi que le bulletin e-mail mensuel. Si tu ne désires pas recevoir le bulletin, coche cette case. Vul je e-mailadres in en we sturen je een bevestiging van je lidmaatschap en maandelijke e-mail nieuwsbrieven. Als je geen e-mail wilt ontvangen, kruis dan dit vakje aan.
- Ich möchte per E-Mail den monatlichen LEGO Club Newsletter erhalten. Ønsker du at vi skal sende en liten hilsen til barnet ditt for å bekrefte medlemskapet, ber vi deg krysse av i feltet, samt oppgi e-postadressen som hilsenen skal sendes til. Om du vill att vi ska skicka en bekräftelse på ditt barns medlemskap, ber vi dig sätta ett kryss i rutan och skriva den e-post adress som bekräftelsen ska skickas till.
- If you do not wish to receive additional mailings from the LEGO Club please tick here. Si tu ne désires pas recevoir de courrier supplémentaire du Club LEGO, coche cette case. Als je geen verdere post van de LEGO Club wilt ontvangen, kruis dan dit vakje aan.
- Dersom du ønsker å motta annen informasjon fra LEGO Gruppen, setter du et kryss her.

<b>Mail to: / Poster à:</b>	<b>LEGO® Club</b> P.O. Box 1157 Enfield, CT USA 06083-1157	<b>Per Post an:</b>	<b>LEGO® Club</b> Postfach 14 15 D-36243 Niederaula	<b>Send til:</b>	<b>LEGO® Club Norge</b> Postboks 58 1314 Vøyenenga
<b>Mail to:</b>	<b>LEGO® Club</b> 33 Bath Road Slough SL1 3UF United Kingdom	<b>Stuur op naar:</b>	<b>LEGO® Club</b> Postbus 40250 3504 AB Utrecht	<b>Skickas till:</b>	<b>LEGO® Club Sverige</b> Ubox 841 202 29 Malmö
		<b>Poster à:</b>	<b>LEGO® Club</b> 21 rue de la banque 75 002 PARIS FRANCE		

US, CA, UK, FR The English language version of the magazine can only be mailed to addresses in the US, Canada, the UK, and Republic of Ireland. Club membership is valid for two years and includes free copies of the LEGO Club Magazine and e-mail newsletters. In the US and Canada please allow up to 6 weeks for delivery of your first magazine. In the UK and Republic of Ireland please allow six to 14 weeks for delivery of your first magazine. By signing this form you consent the LEGO Club to use your child's data for LEGO mailings. The data will only be used for LEGO mailings and will not be sold, rented or otherwise disclosed to any company outside the LEGO Company except for disclosure to companies acting as our agents to help us provide services requested by the child. This coupon is valid for one free membership per person, group or organization. Photocopied coupons are accepted. FR La version française du magazine peut être postée uniquement au Canada. L'abonnement est valide pour 2 ans et inclut des exemplaires gratuits du Magazine LEGO. Aux E-U et au Canada, allouer 6 semaines pour la livraison initiale. En remplissant ce formulaire, vous consentez à ce que LEGO utilise les informations de votre enfant pour des envois postaux de LEGO. L'information sera utilisée uniquement pour des envois postaux par LEGO et ne sera en aucun cas, vendue, louée, échangée ou divulguée à d'autres compagnies autres que la compagnie LEGO, à l'exception des compagnies affiliées qui nous procurent des services auxquels l'enfant en a fait la demande. Formulaires photocopiés acceptés. NO Mit der folgenden Unterschrift erkläre ich, für mein Kind den Beitritt als Mitglied zum kostenlosen LEGO Club, der von der LEGO GmbH, D-85627 Grasbrunn, betrieben wird. Die Mitgliedschaft beinhaltet die Zusendung des LEGO Club Magazines und kann beiderseits jederzeit beendet werden. Mit der Mitgliedschaft im LEGO Club sind keinerlei Verpflichtungen verbunden. Das deutschsprachige LEGO Club Magazin wird nur an Adressen in Deutschland, Österreich und der Schweiz versendet. Eine Anmeldebestätigung kann nur per E-Mail geschickt werden. Das Magazin erscheint fünfmal jährlich. Daher kann die Zustellung des ersten Hefes bis zu drei Monate dauern. Die Mitgliedschaft ist beidseitig jederzeit kündbar, ohne dass Ihnen Kosten entstehen. Sie können der werblichen Nutzung Ihrer Daten jederzeit widersprechen. Kündigung und Widerspruch können Sie telefonisch erklären (00800 / 5346 5555, Anruf gebührenfrei, Kosten für Anrufe aus dem Mobilfunknetz können abweichen) oder an die LEGO GmbH senden. SE Het Nederlandse LEGO Club Magazine kan alleen worden gestuurd naar adressen in Nederland. Het lidmaatschap is 2 jaar geldig en geeft recht op toezending van het gratis LEGO Club Magazine en LEGO Club e-mails. Het eerste magazine zal binnen 12 tot 14 weken toegestuurd worden. Het lidmaatschap kan op ieder moment opgezegd worden en kan na 2 jaar gratis worden verlengd, tenzij LEGO met deze activiteit stopt. Uw gegevens worden uitsluitend gebruikt voor mailings van LEGO en zullen niet worden verkocht, verhuurd of op welke wijze dan ook verstrekt aan derden buiten de LEGO Groep, uitgezonderd de organisaties die namens ons optreden om de informatie te sturen waarvoor toestemming is verleend. NO Den norske utgaven av magasinet sendes kun til adresser i Norge. Medlemskap i klubben gjelder i 2 år og inkluderer gratisutgaver av LEGO Club Magazine. Pårign minimum opp til seks uker leveringstid for første magasin. Ved å undertegne dette skjemaet, gir du ditt samtykke til at LEGO Club kan bruke opplysningene om barnet ditt i LEGO forsendelser. Dataene vil utelukkende bli brukt i LEGO forsendelser og vil ikke bli solgt, utleid eller på annen måte gjøres tilgjengelig for selskaper utenfor LEGO gruppen, unntatt selskaper som er våre agenter og som hjelper oss å tilby tjenestene barnet ettersper. Dette skjemaet gjelder for ett gratis medlemskap per person, gruppe eller organisasjon. SE Den svenska versionen av tidsningen kan endast skickas till adresser i Sverige. Club-medlemskapet är giltigt i 2 år och innefattar gratis exemplar av LEGO Club Magazine. Vänligen räkna med minimum 6 veckor för leverans av din första tidning. Genom att skicka in det här formuläret godkänner du att LEGO Club använder barnets uppgifter för LEGO utskick. Uppgifterna kommer bara att användas för LEGO utskick och kommer inte att säljas, hyras ut eller vidarebefordras till något företag som inte tillhör LEGO Gruppen, med undantag av företag som agerar som våra ombud för att tillhandahålla tjänster som barnet har begärt. Den här kupongen gäller för ett gratis medlemskap per person, gruppe eller organisation. FR En complétant ce bulletin d'adhésion, vous acceptez que LEGO Club utilise les données relatives à votre enfant pour l'envoi de courriers concernant LEGO. Ces données seront uniquement utilisées pour l'envoi d'information concernant LEGO et ne seront ni vendues, ni louées, ni utilisées par d'autres sociétés que le groupe LEGO, à l'exception des sociétés agissant pour le compte de LEGO en tant que sous-traitant de services divers. L'abonnement au LEGO Club est valable pour une période de 2 ans. Il inclut l'envoi par courrier du magazine LEGO Club et par email des newsletters. Un délai de 6 à 14 semaines est à prévoir pour la réception de votre premier magazine. Ce bulletin d'adhésion gratuit est valable pour l'inscription d'une seule personne. Les photocopies sont acceptées. ATTENTION! Le bulletin d'adhésion doit être rempli et signé par un parent ou un tuteur.

Parent's signature · Signature d'un parent ou d'un tuteur  
 • Unterschrift Erziehungsberechtigte(r) · Handtekening ouders  
 • Foreldres/foresattes underskrift · Förälders /förmyndares underskrift

Date  
Datum  
Date

B1119



LEGO and the LEGO logo are trademarks of the/son des marques de commerce de/son marcas registradas de LEGO Group. ©2012 The LEGO Group. 6029683 / 6029684

YES OF THE WORLD'S BIGGEST LEGO® SHOP!  
[www.LEGOshop.com](http://www.LEGOshop.com)  
 08 70  
[www.LEGOclub.com](http://www.LEGOclub.com)

00800 5346 5555  
 1-866-534-6258 · 1-877-518-5346

\* Freephone. Mobile charges may apply. \* Numéro sans frais. Des frais peuvent s'appliquer avec les téléphones cellulaires. \* Gebührenfrei. Kosten für Anrufe aus Mobilfunknetzen können abweichen. \* Gratis telefonnummer vanaf vaste lijn. \* Det er et gratis nummer, når du ringer fra fasttelefon. \* Det är gratis, när du ringer från en fast telefon. \* Numéro sans frais. Des frais peuvent s'appliquer avec les téléphones portables.