



CREATOR

6914



1

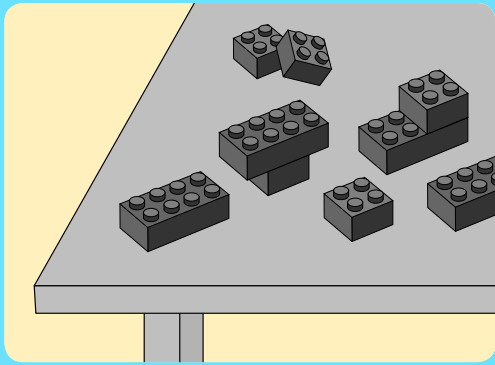
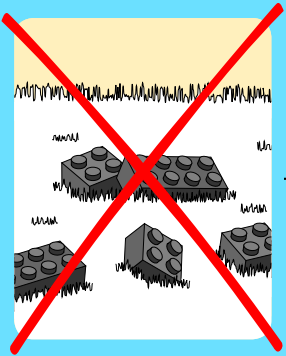

2

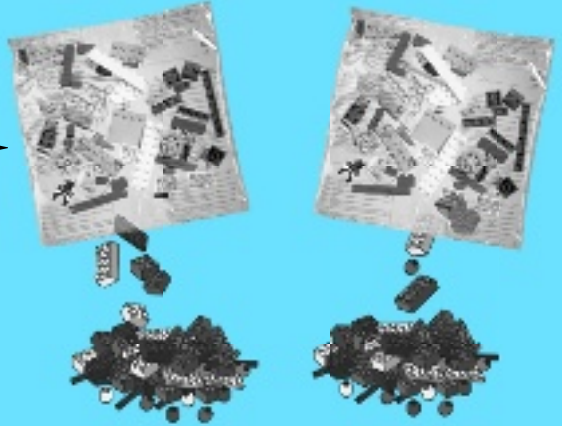

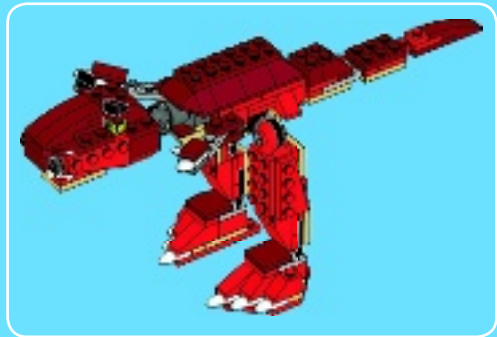

1x

1

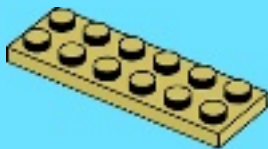

1x

2

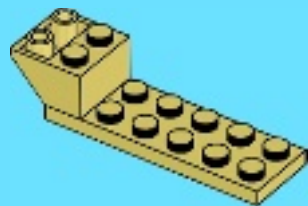



1x

3

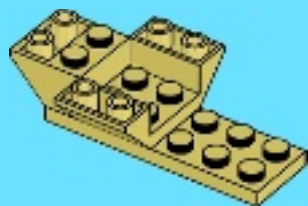

4



1x



1x

4

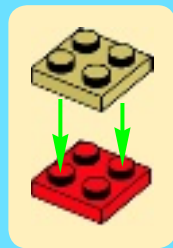



1x

5



1x



2x



1x

6

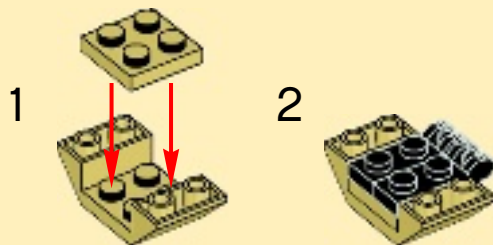



1x



1x

7

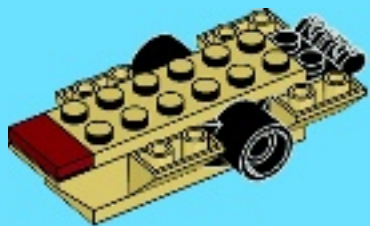

6



1x



2x

8





2x



2x

9

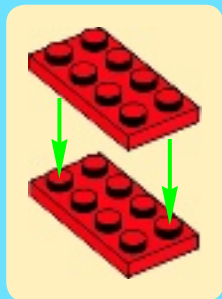



1x



1x



2x

10

1



2



3





1x



1x



2x

11

1



2



3





1x



2x



2x

12



1x



2x

13





1x



4x

14



2x

15





1x

1



1x



2x

2



1x

3





1x



1x

4

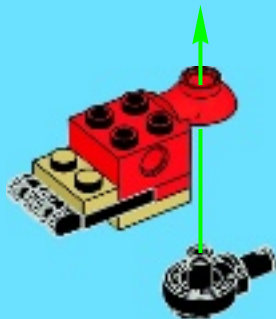

1x

5





1x



1x

6

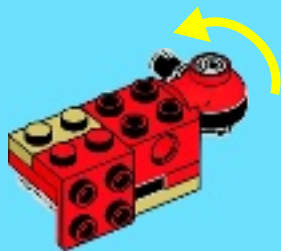

1x



1x

7



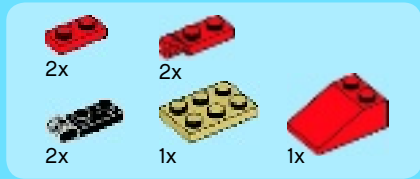

8

1



2



3

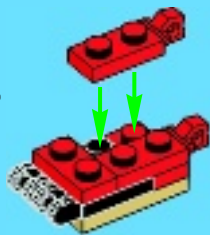

4

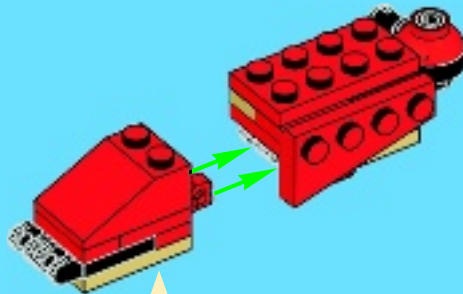



1x

1



1x



1x



1x

2

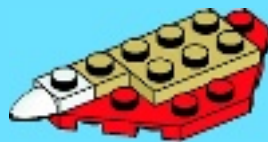



1x



2x

3



1x



1x



1x

4





1x



2x

5



1x



1x

6



7

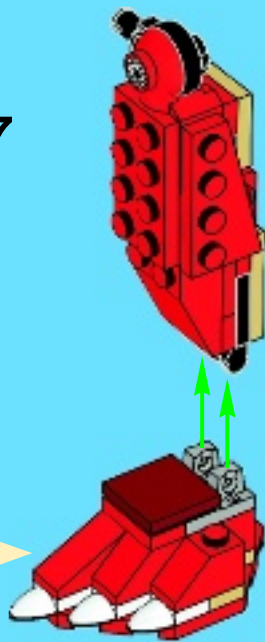

16

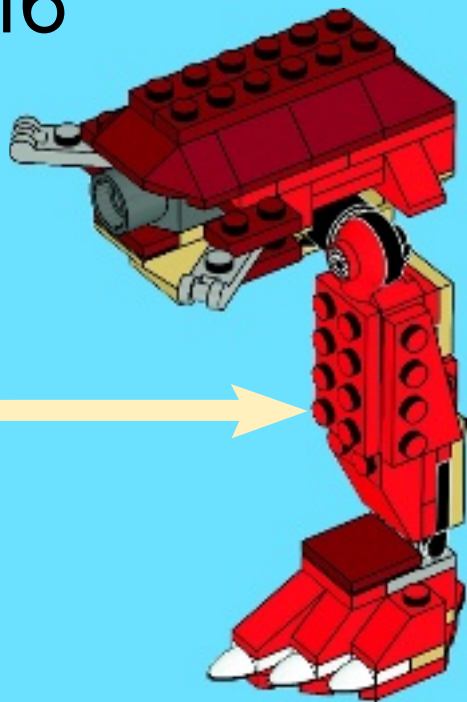



1x

1



1x



2x

2



1x

3





1x



1x

4

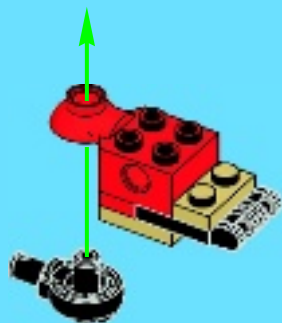

1x

5





1x



1x

6



1x



1x

7



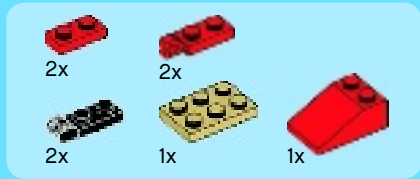

8

1



2



3

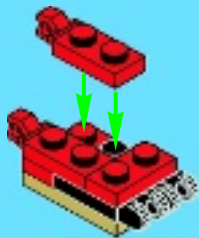

4

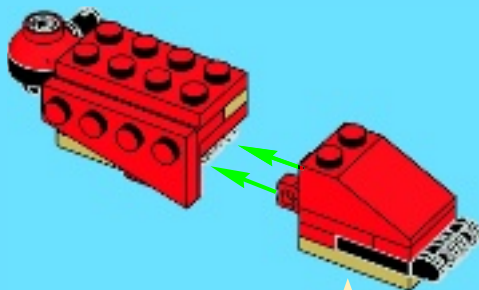



1x

1



1x



1x



1x

2





1x



2x

3



1x



1x



1x

4





1x



2x

5



1x



1x

6



7

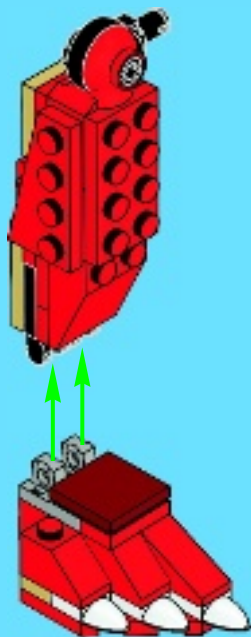

17

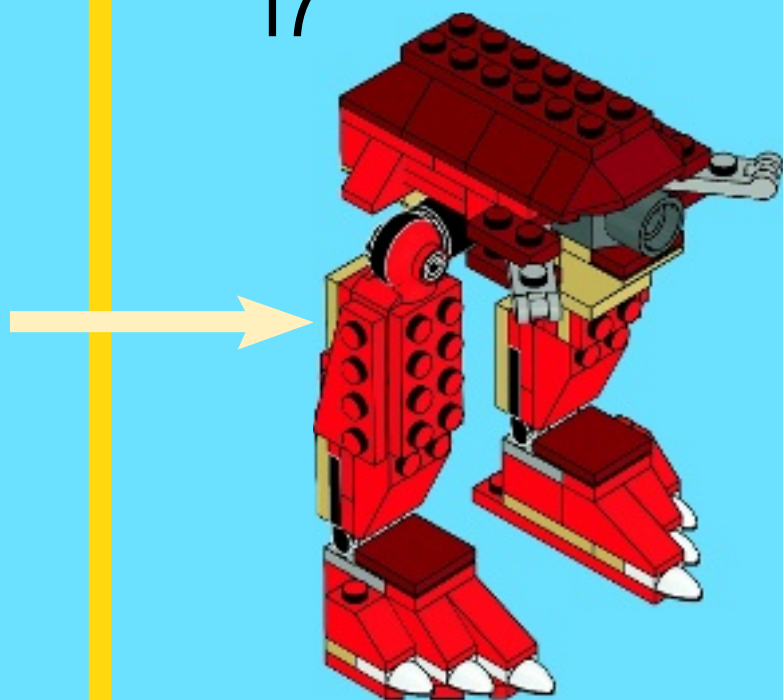



2x



2x



4x

18

1



2



3

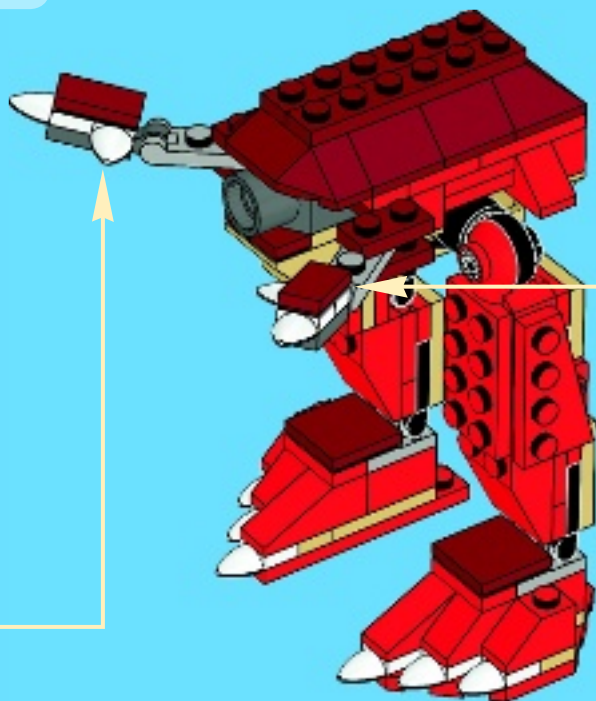

1



2

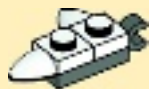

3





1x

1



2x

2





1x



1x

3

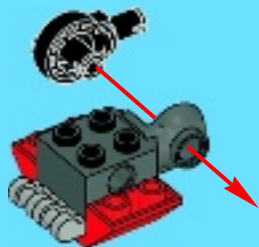

2x

4





1x



1x



1x



1x



1x

5

1



2



3

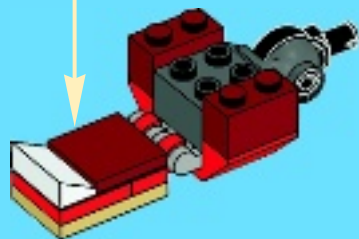



1x



1x

6

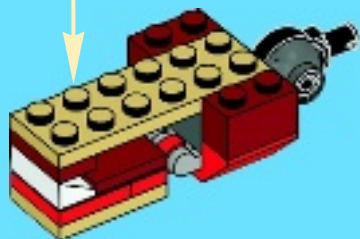

1x



1x

7

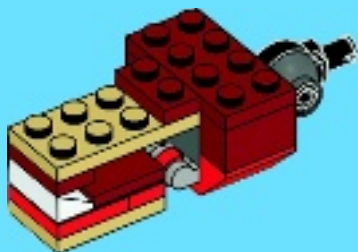

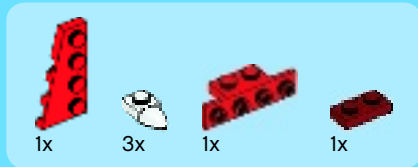

8

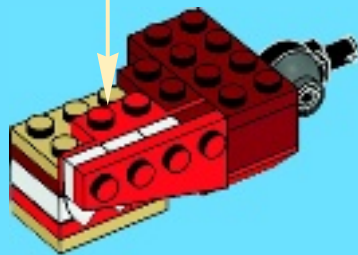



1x



3x



1x



1x

9

1



2



3

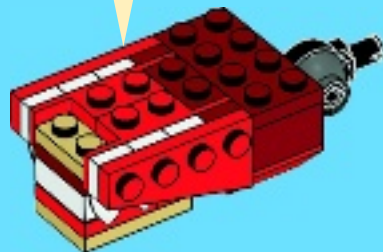

2x

2x

1x

1x

10

1



2



3

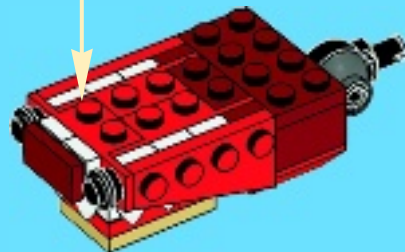



4x



2x



1x

11

1



2



2x

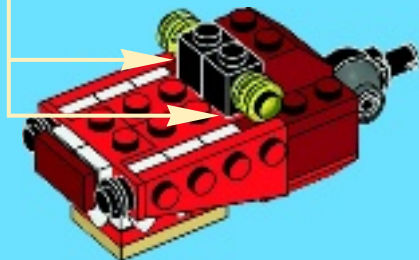



1x



1x

12



3x

13

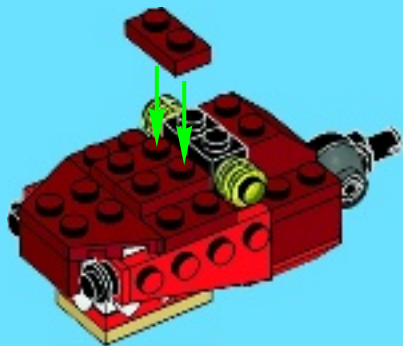



2x



2x

14



2x

15

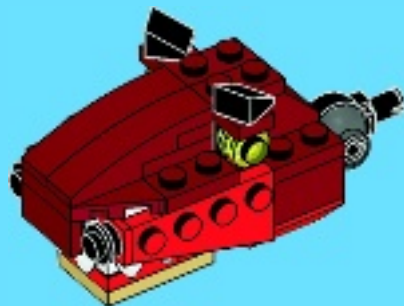

19

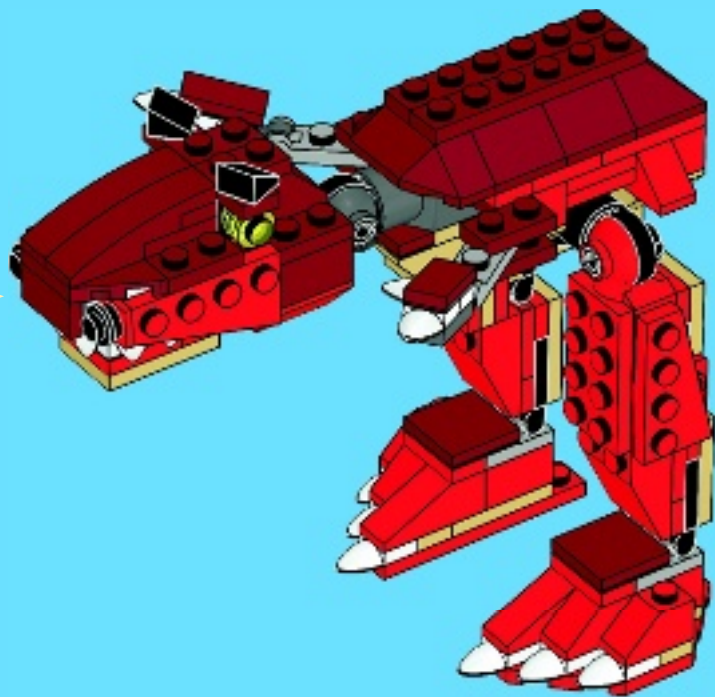



1x

1



1x



2x

2





2x



1x

3



1x



1x

4





1x



1x



1x



2x



1x

5

1



2



3

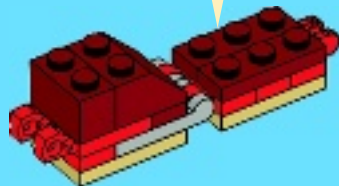
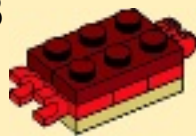

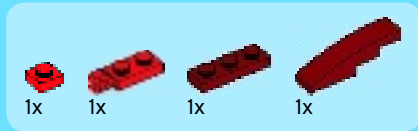

6

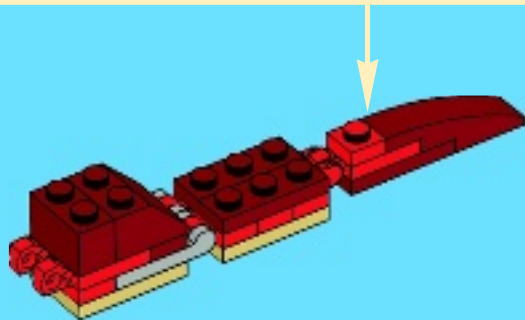
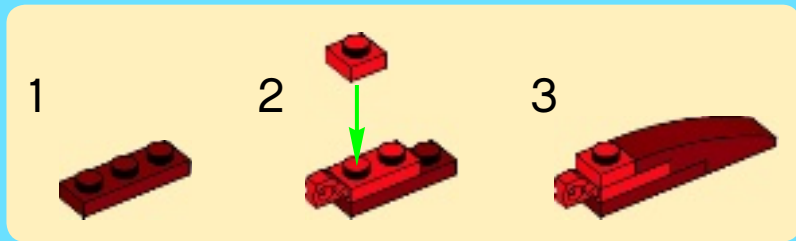

20

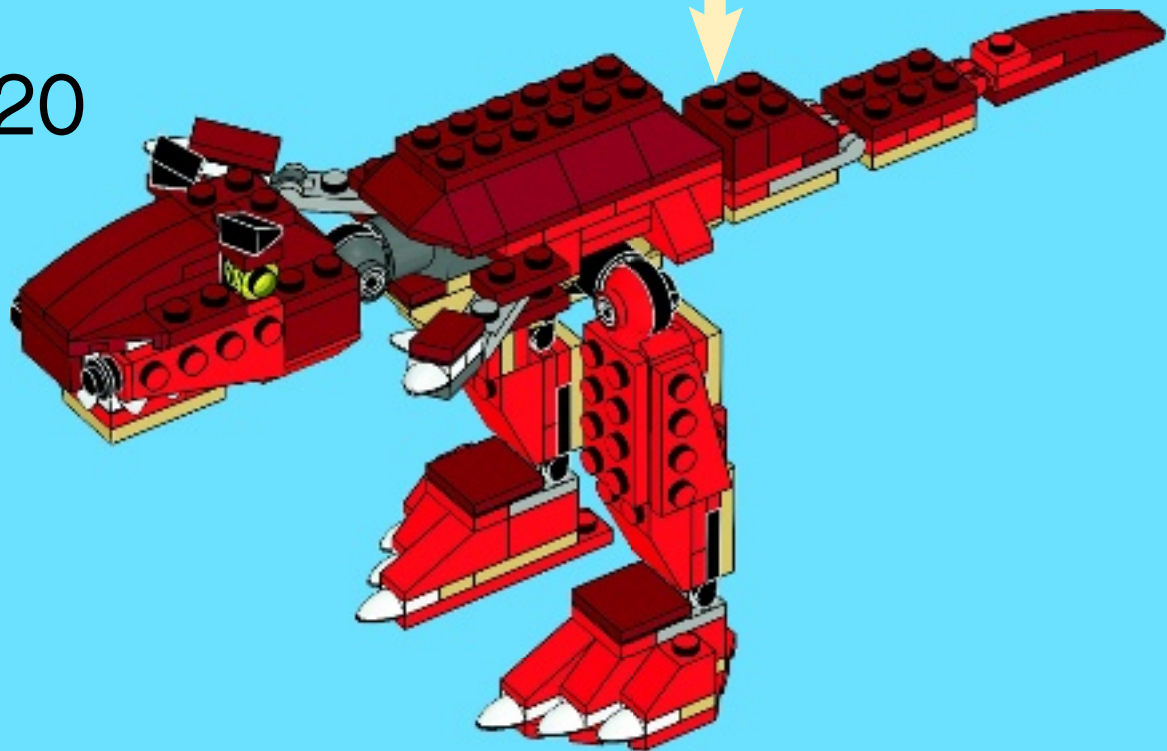

1x
4547489

18x
4224792

1x
4118866

2x
4655082

4x
4159553



4x
4113917

4x
4114084

7x
4118790

3x
4113993

2x
300521

2x
300321

1x
301021

2x
4225923

6x
4121934

2x
428621

2x
329821

1x
487121

3x
302421

10x
302321

4x
302221

2x
302121

5x
302021

1x
4515338

2x
4277933

2x
4556153

7x
4183039

3x
4282742

2x
4160866

2x
4161329

2x
241921

1x
4225973

1x
4225975

2x
4581225

8x
4539097

4x
4219913

6x
4515369

4x
3005749

2x
4558954

2x
4504382

10x
4183060

4x
614126

3x
4213374

1x
4275826

6x
4585751

3x
4539102

6x
4609925

2x
4600467

1x
4539081

3x
4551604

3x
4539076

2x
4539071

2x
4539062

4x
4539090

3x
4539105

1x
4541544



Customer Service

Kundenservice

Service Consommateurs

Servicio Al Consumidor

www.lego.com/service or dial



: 00800 5346 5555

: 1-800-422-5346



CREATOR



6912



7291



6913



7292





www.LEGOclub.com



LEGO® Club Email



LEGO® Club Magazine

LEGO club™

FREE! GRATIS! GRATUIT!

SIGN UP ONLINE!

www.LEGOclub.com



00800 5346 5555*



1-866-534-6258 • 1-877-518-5346

KG © Canada only

Canada seulement

- * Freephone. Mobile charges may apply.
- * Numéro sans frais. Des frais peuvent s'appliquer avec les téléphones cellulaires.
- * Gebührenfrei, Kosten für Anrufe aus Mobilfunknetzen können abweichen.
- * Gratis telefonnummer vanaf vaste lijn.
- * Det er et gratis nummer, når du ringer fra fasttelefon.
- * Det är gratis, när du ringer från en fast telefon.
- * Numéro sans frais. Des frais peuvent s'appliquer avec les téléphones portables.



WIN!

Go to www.LEGOsurvey.com/product to fill out a survey for a chance to win a cool LEGO® Product.

No purchase necessary.

Open to all residents where not prohibited.



www.LEGOsurvey.com/product

GEWINNE!

Nimm an der Umfrage auf www.LEGOsurvey.com/product teil und hab die Chance ein cooles LEGO® Produkt zu gewinnen!

Die Teilnahme am Gewinnspiel führt zu keinerlei Kaufverpflichtungen. Teilnahme in allen nicht ausgeschlossenen Ländern möglich.

WIN!

Ga naar www.LEGOsurvey.com/product, vul een enquêteformulier in en maak kans op een cool LEGO® product.

Geen aankoopverplichting. Iedereen mag deelnemen, uitgezonderd ingezetenden van landen waar een enquêteverbod geldt.

GAGNE!

Visite www.LEGOsurvey.com/product pour répondre à un questionnaire et avoir une chance de gagner un produit LEGO® très cool!

Aucune obligation d'achat. Ouvert à tous les résidents des pays autorisés.

当てよう!

www.LEGOsurvey.com/product にアクセスして、アンケートにご記入ください。当選者にはレゴ®製品を差し上げます。

お買い上げの必要はありません。禁止されていない限り、すべての皆様にご利用いただけます。



www.LEGO.com

6008499 / 6008501

LEGO and the LEGO logo are trademarks of the/son des marques de commerce de/son marcas registradas de LEGO Group. ©2012 The LEGO Group.