

# Kingdoms



10223

LEGO







1

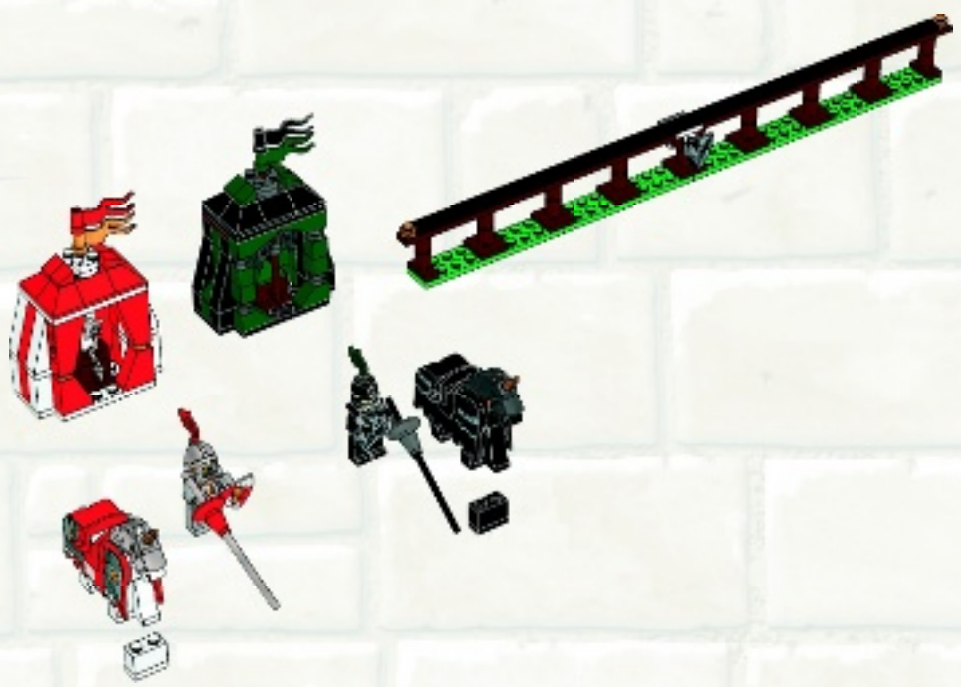

2

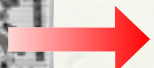

3



4



5



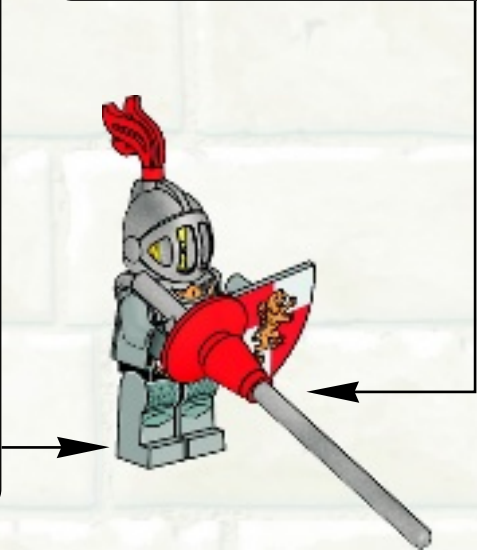
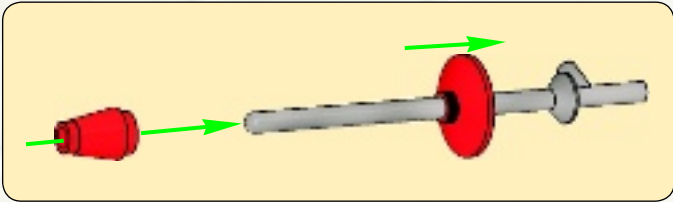
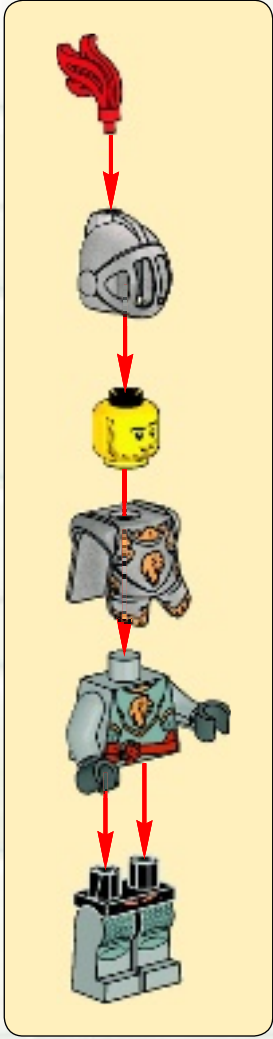
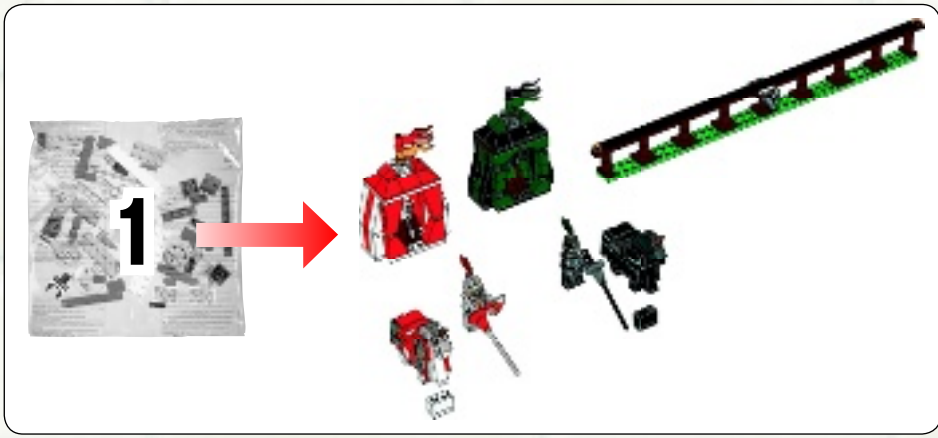

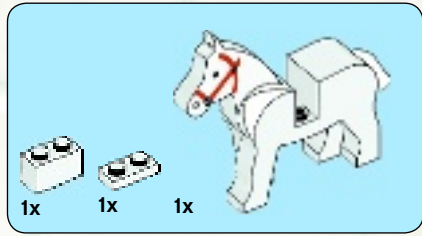

1

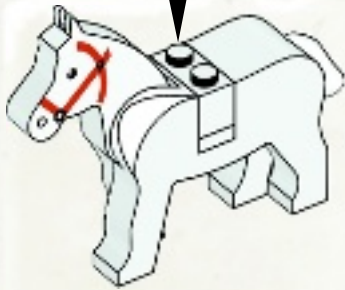

2

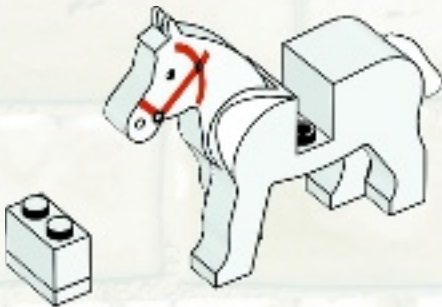

4

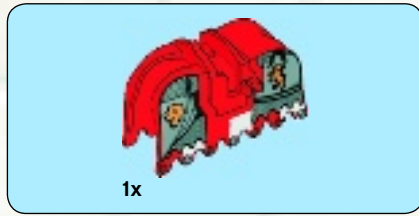

3

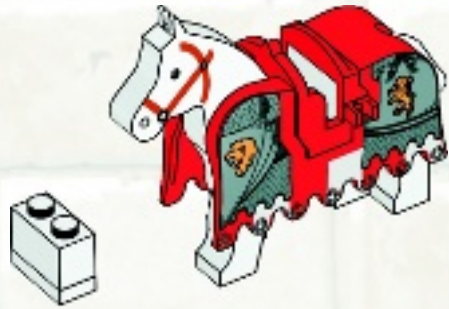

4

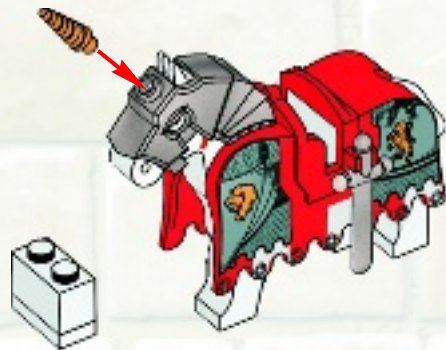



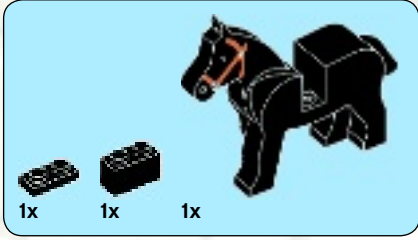

1

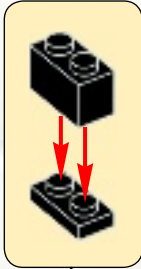

2

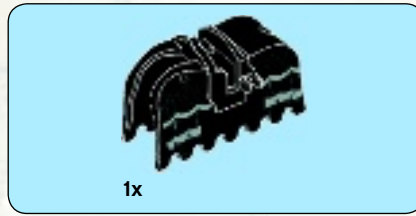

3



4



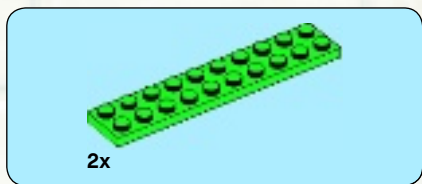
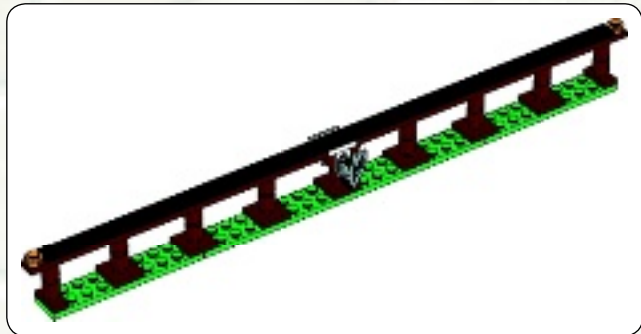

1

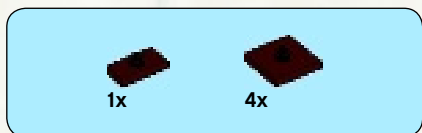
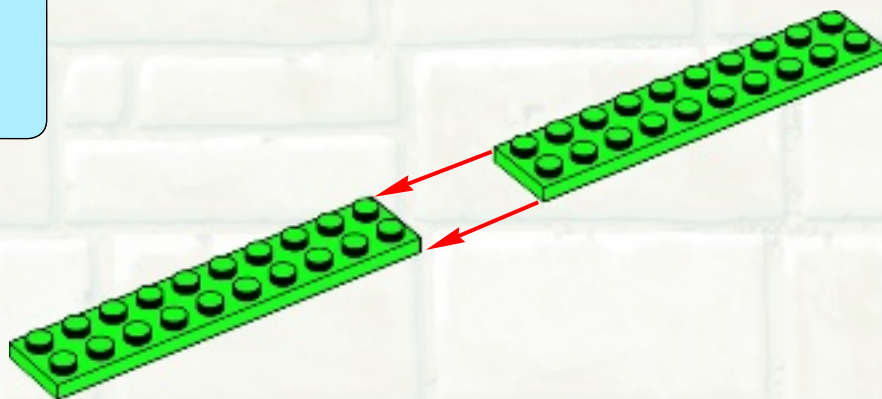

2

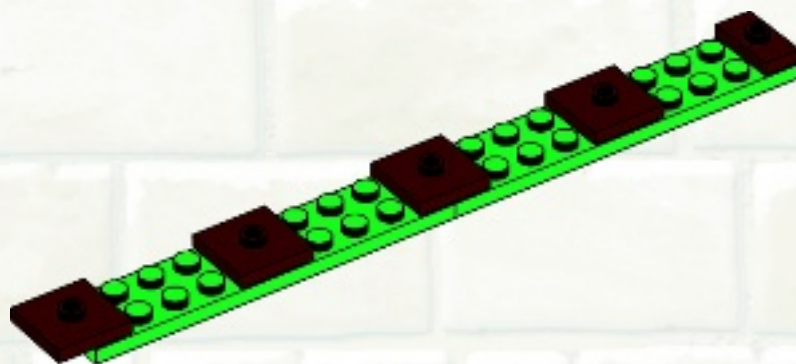



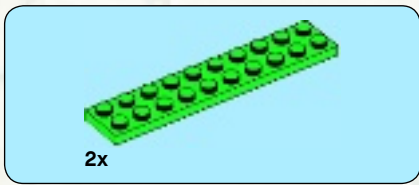

3

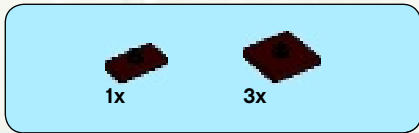
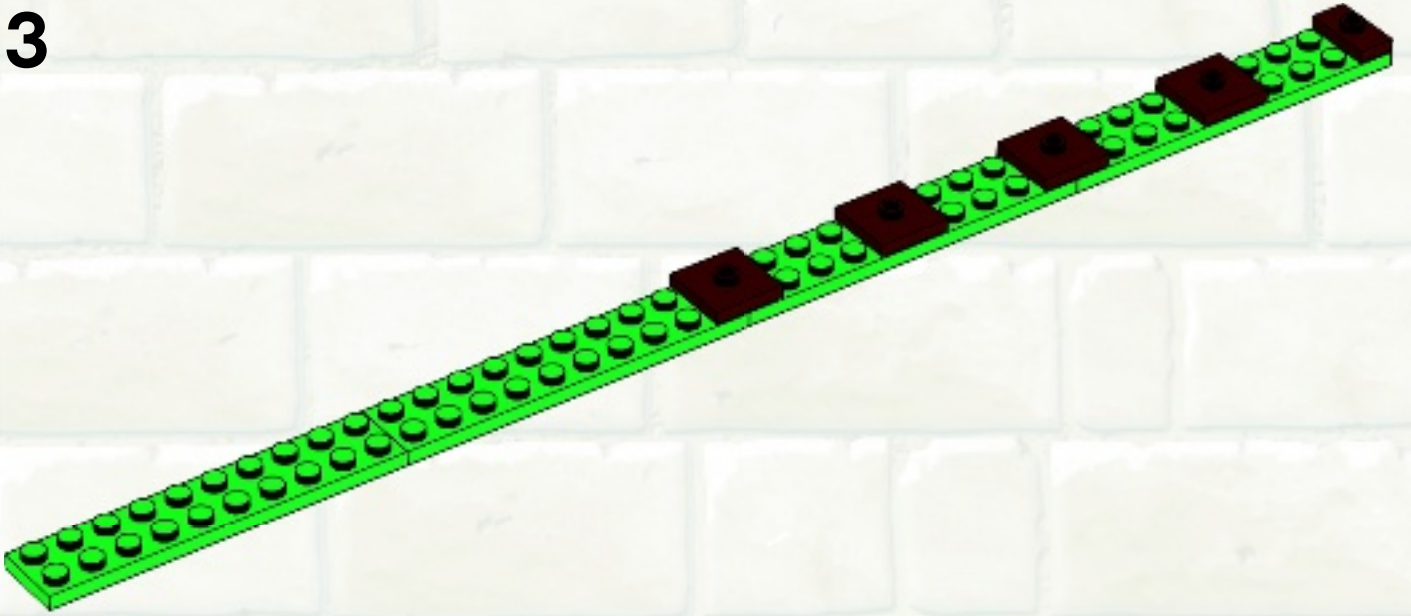

4

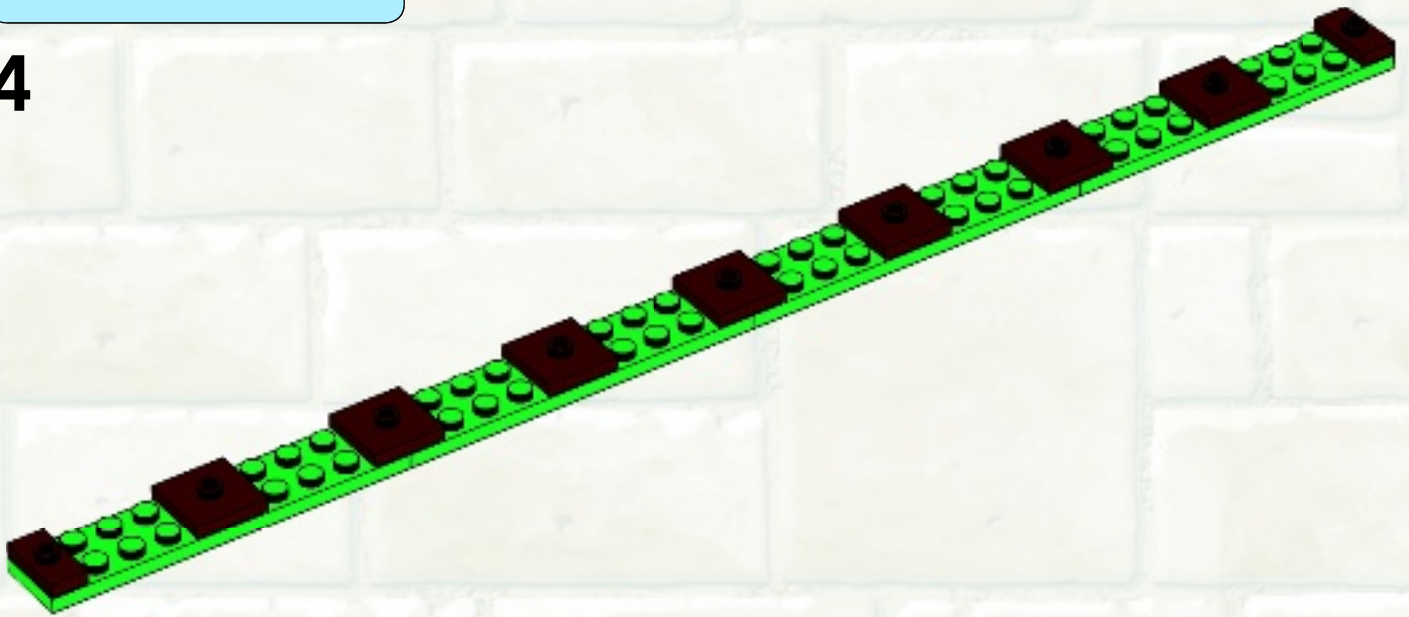

17x

5

8x

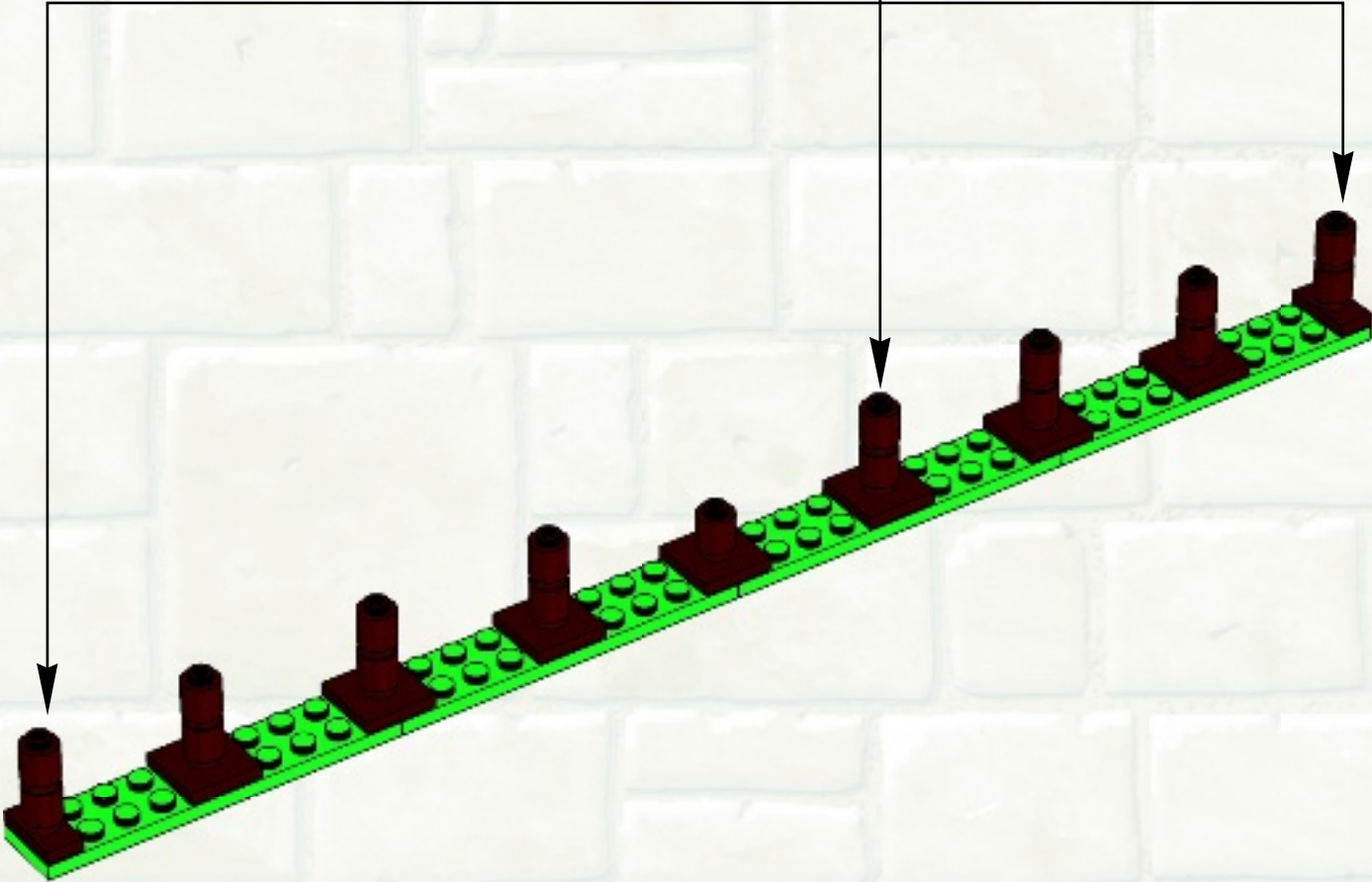





1x



2x

6

1



2

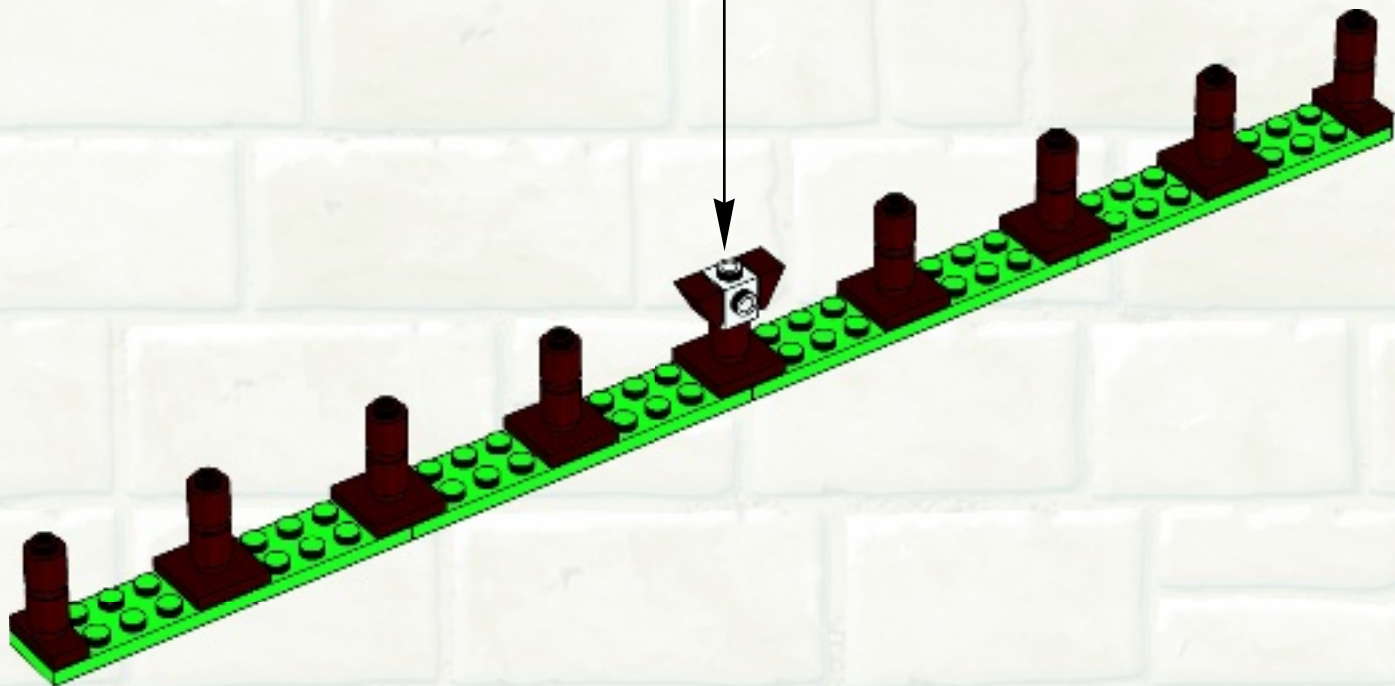



7

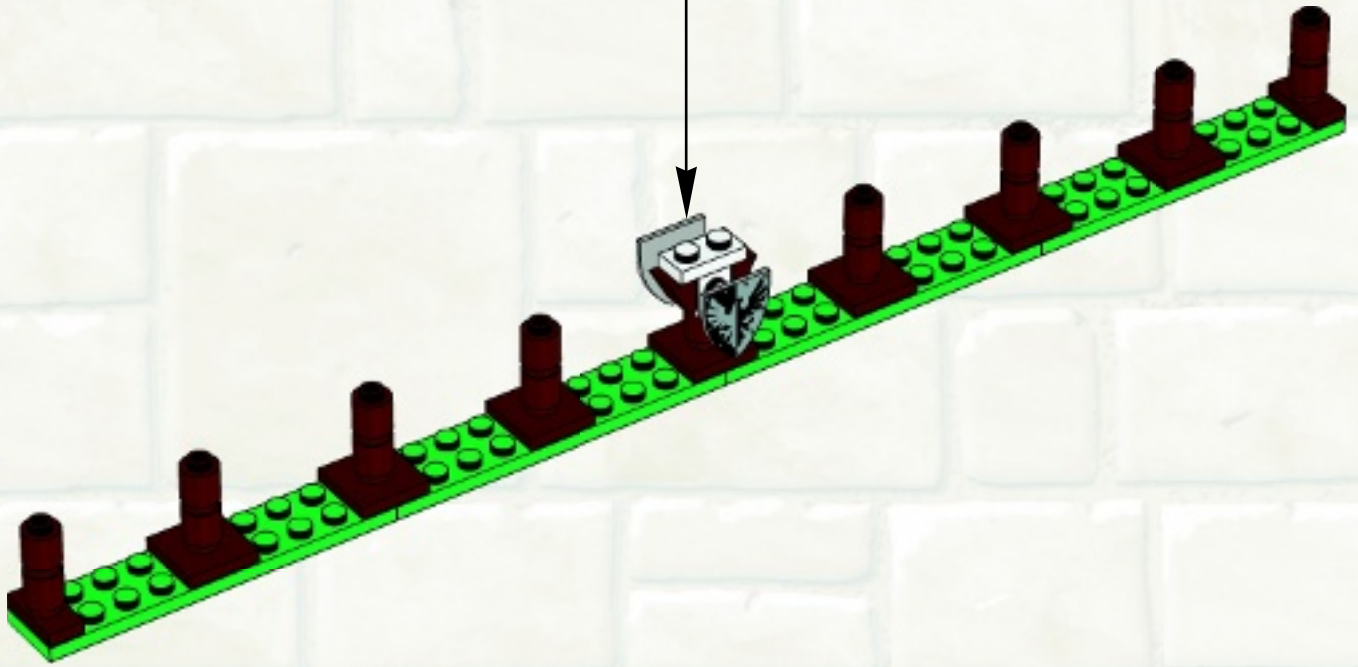



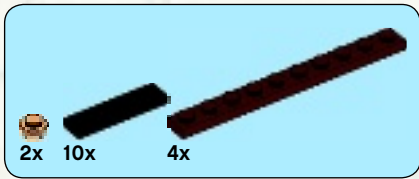

8

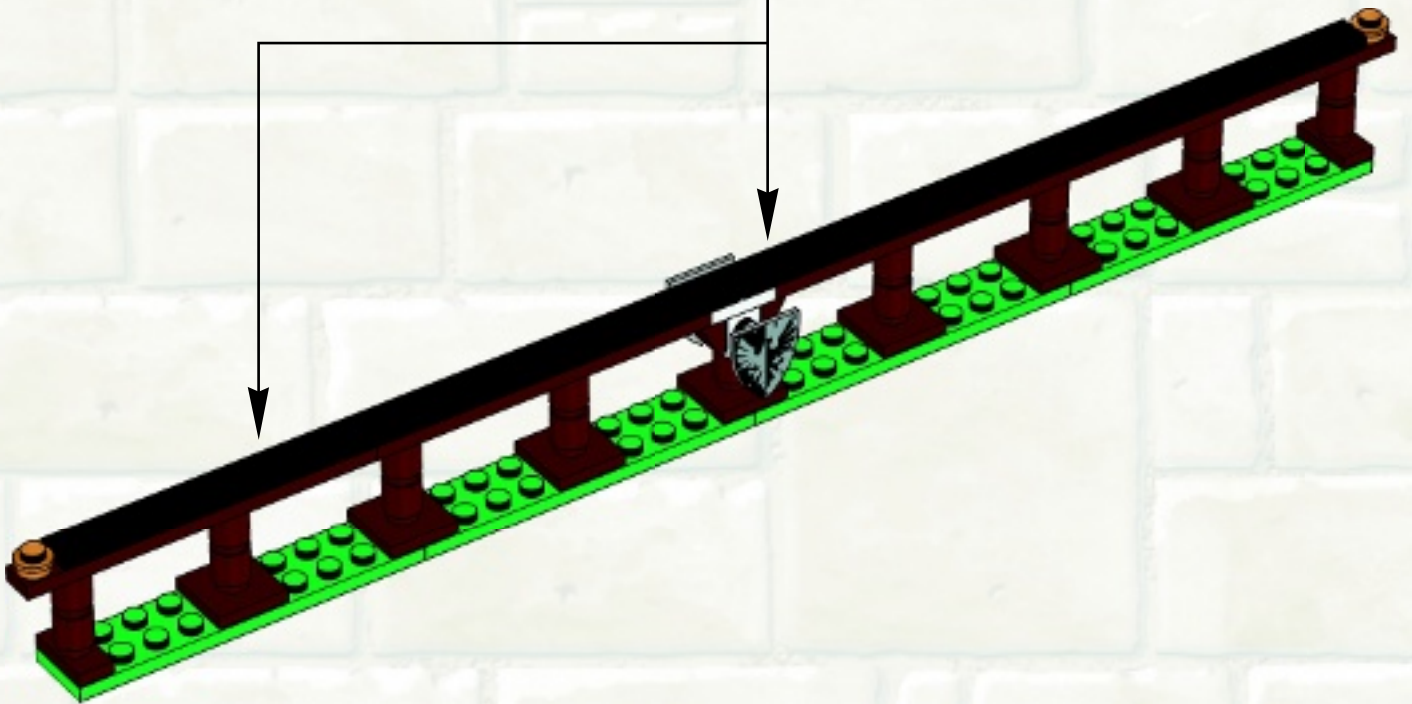
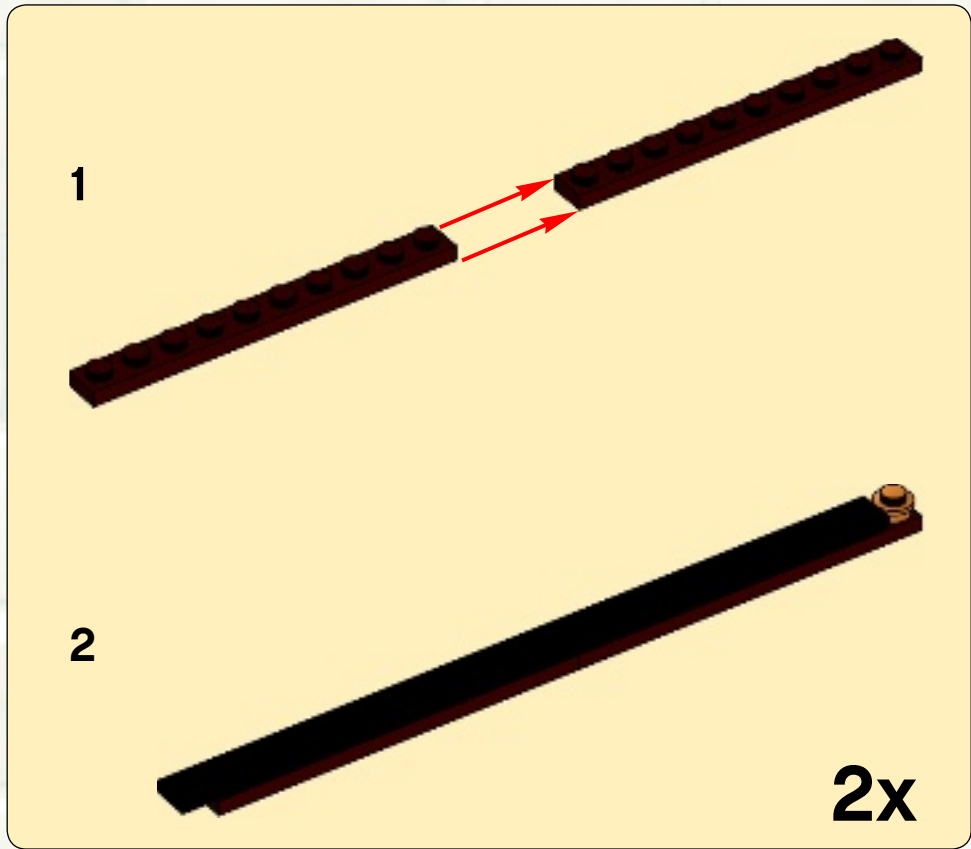



1

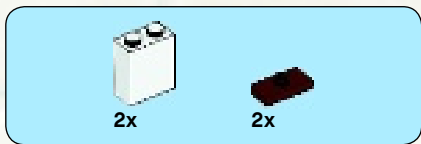
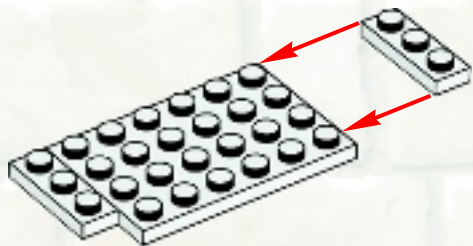

2

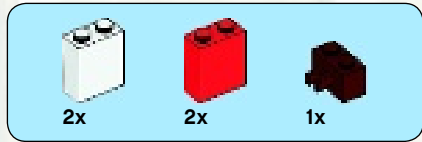
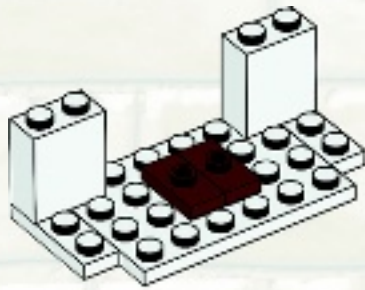

3

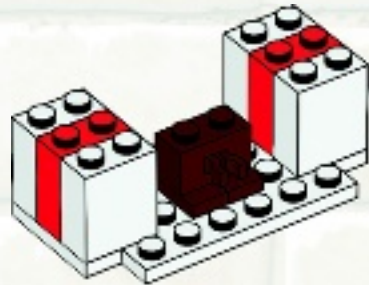

4

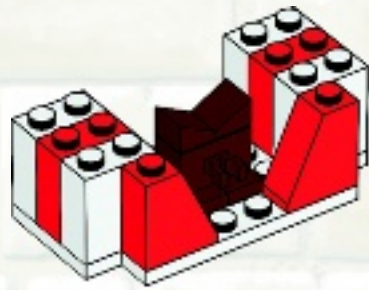

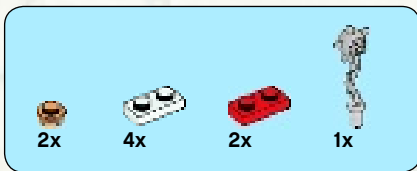

5

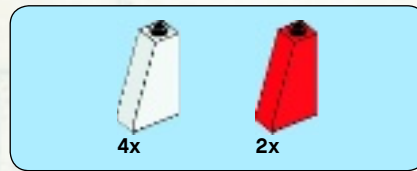
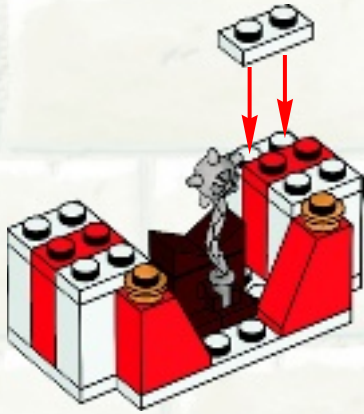

7

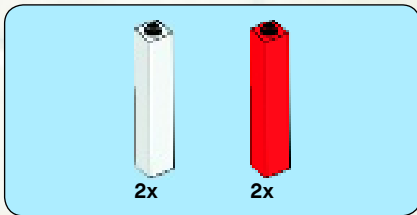

6

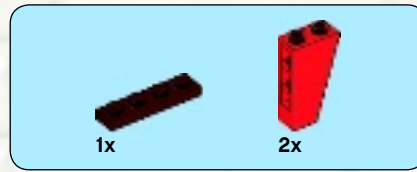

8





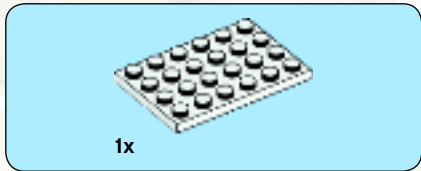

9



10

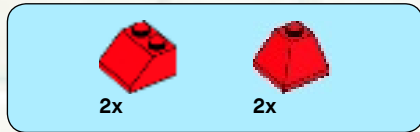

11



12



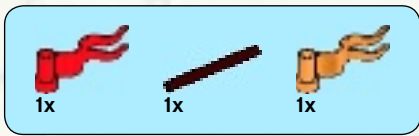

13

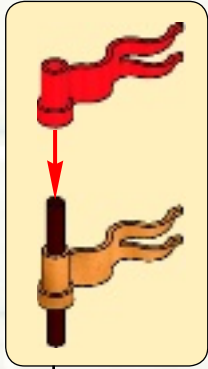

1

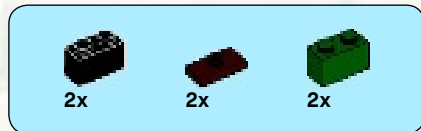
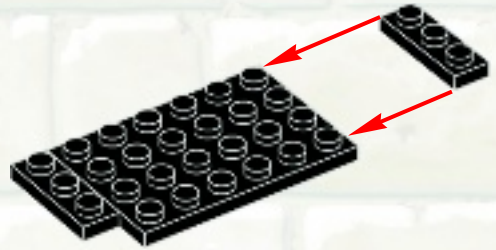

2

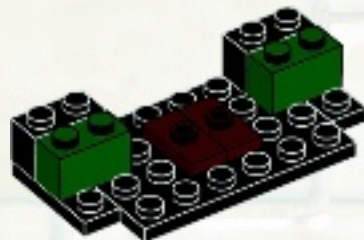

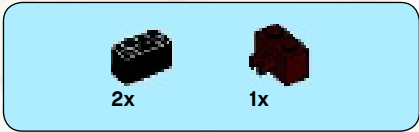

3

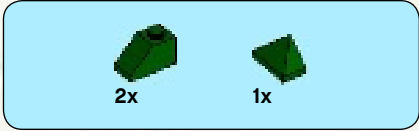
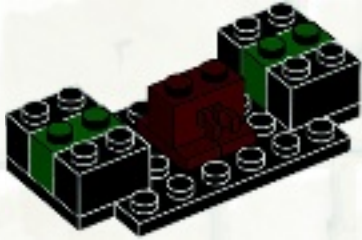

4

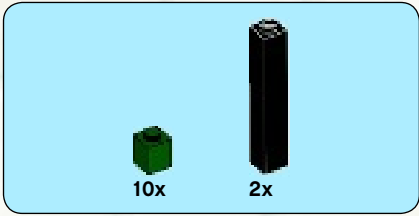

5

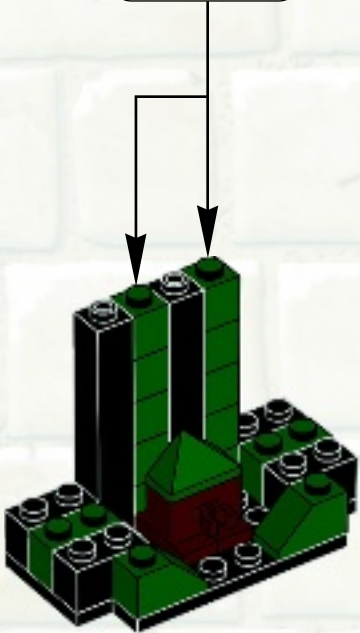
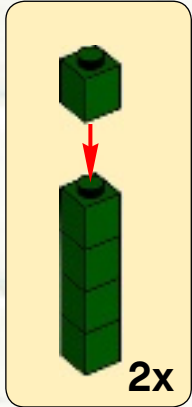



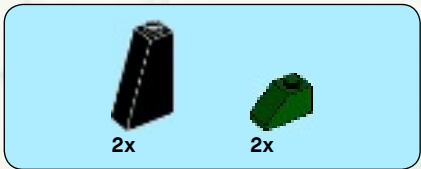

6

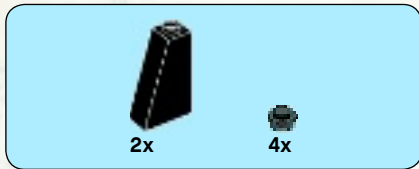
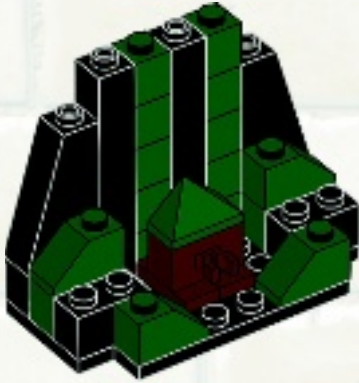

8

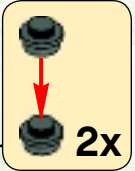
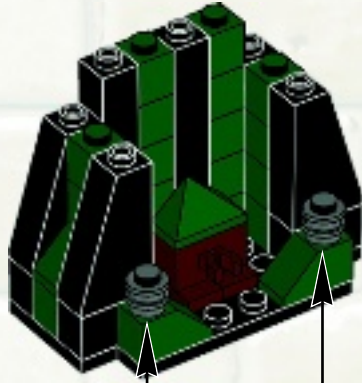

7

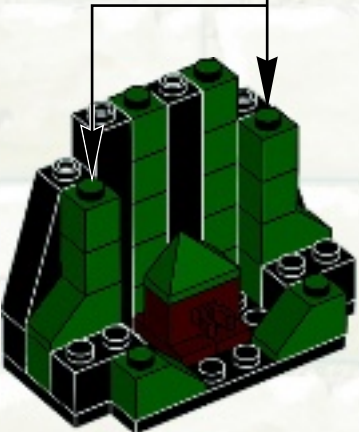
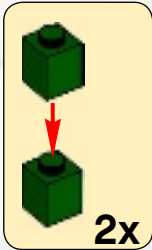

9

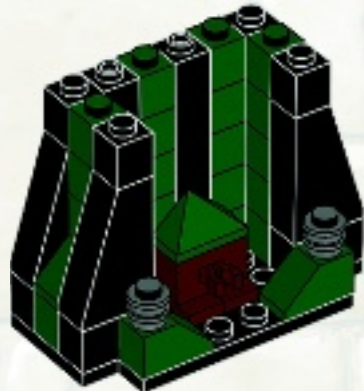



10

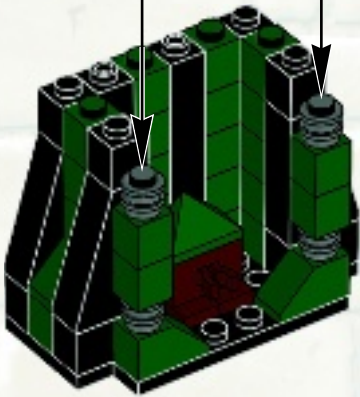
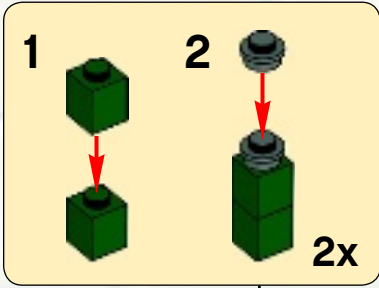

11

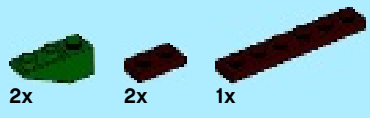
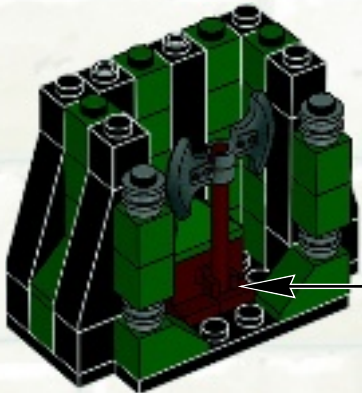

12

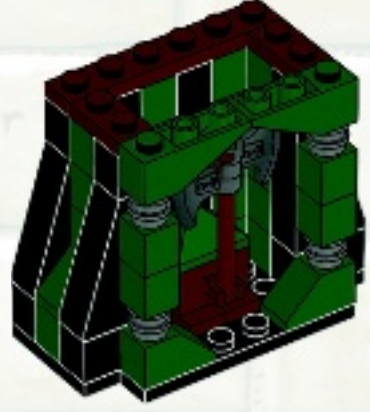

13





14

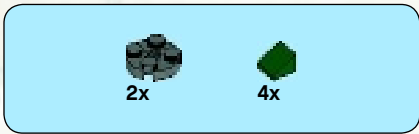
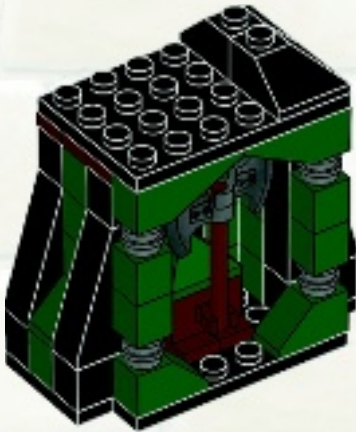

16

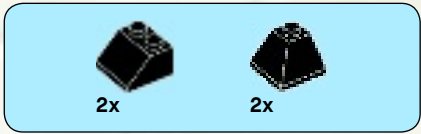
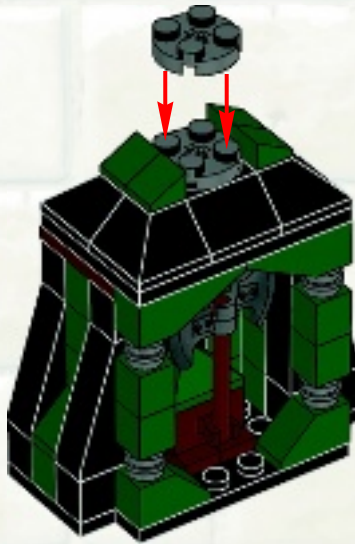

15

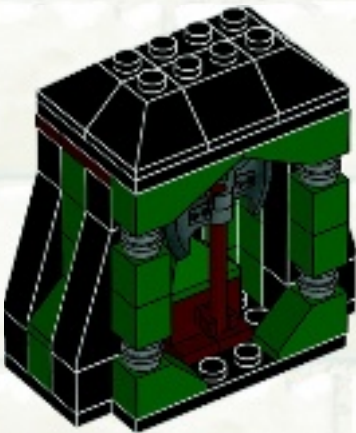

17

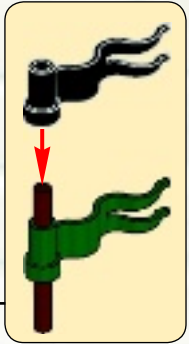
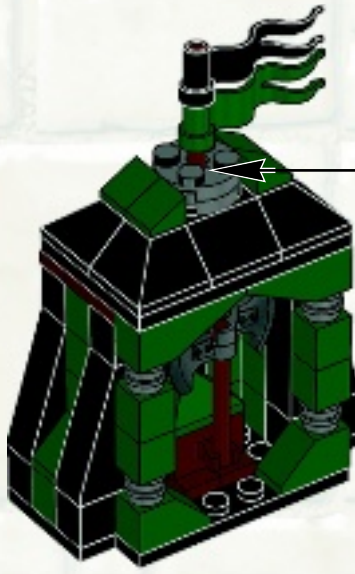



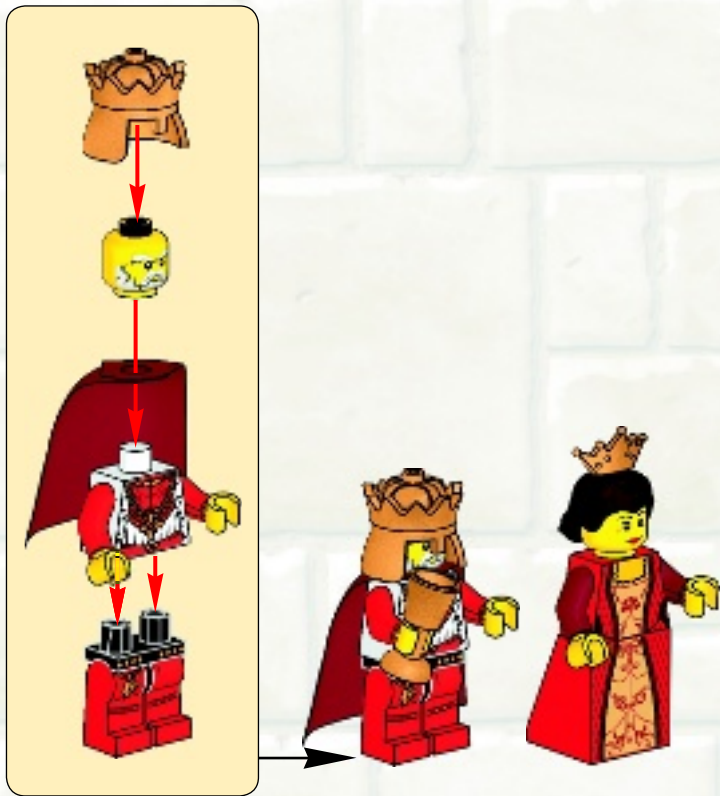
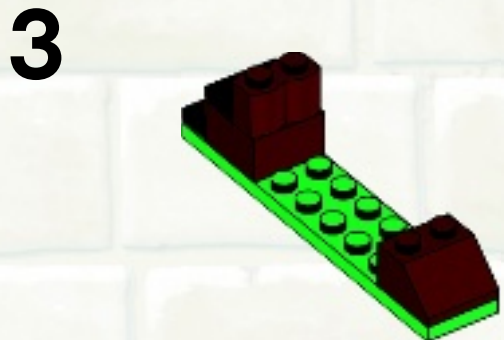
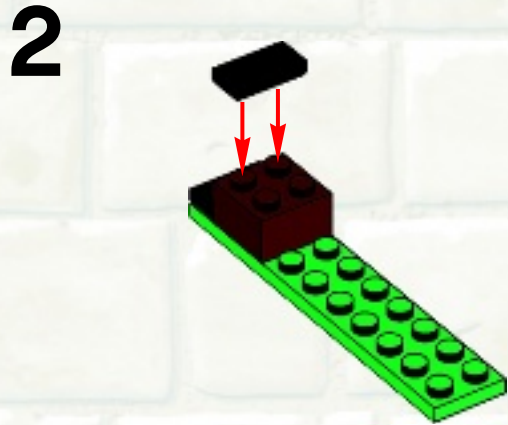
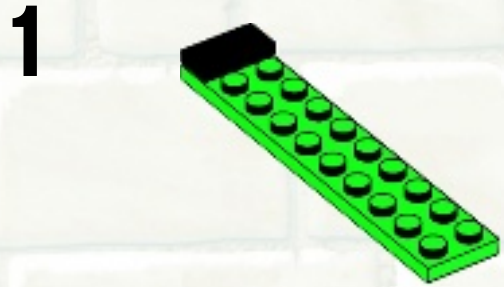
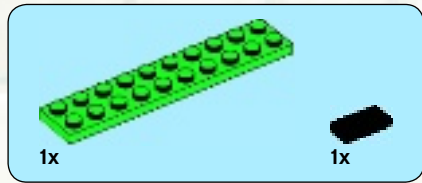
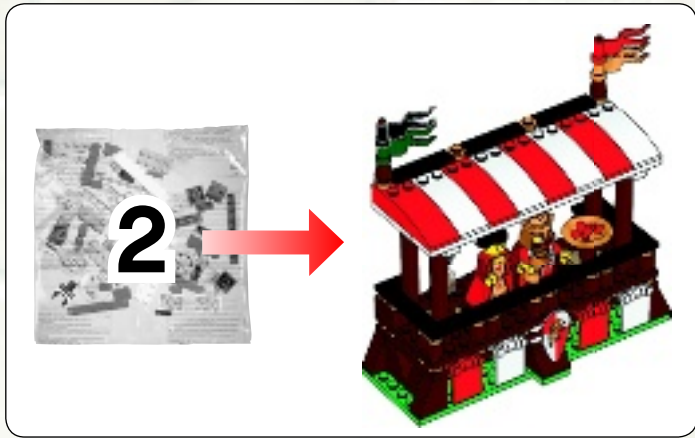

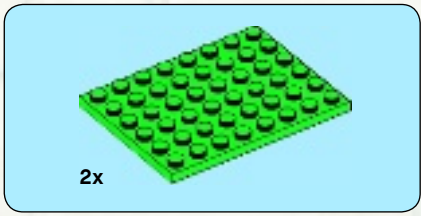

4

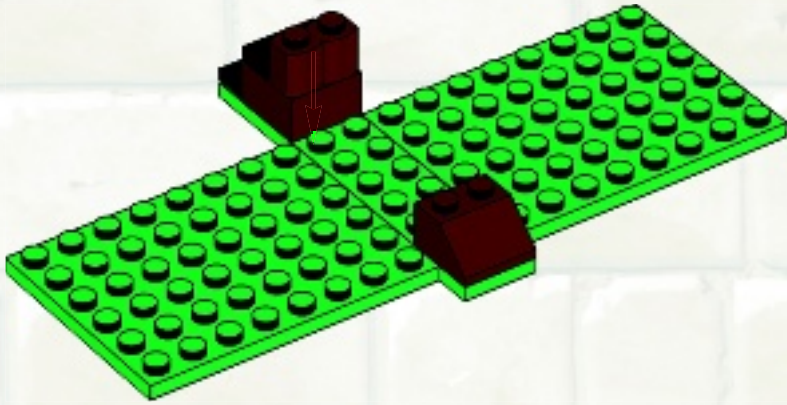

5

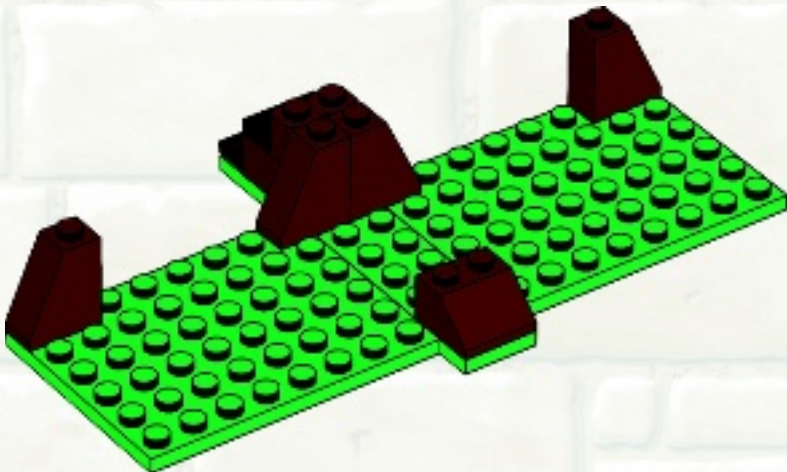



6

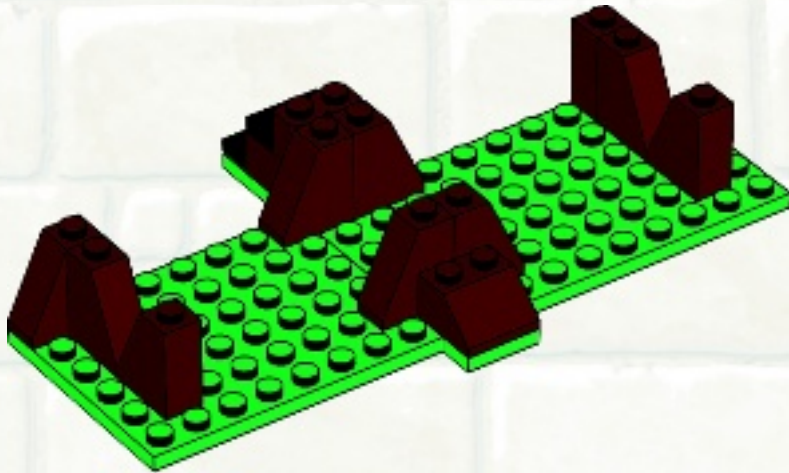

7

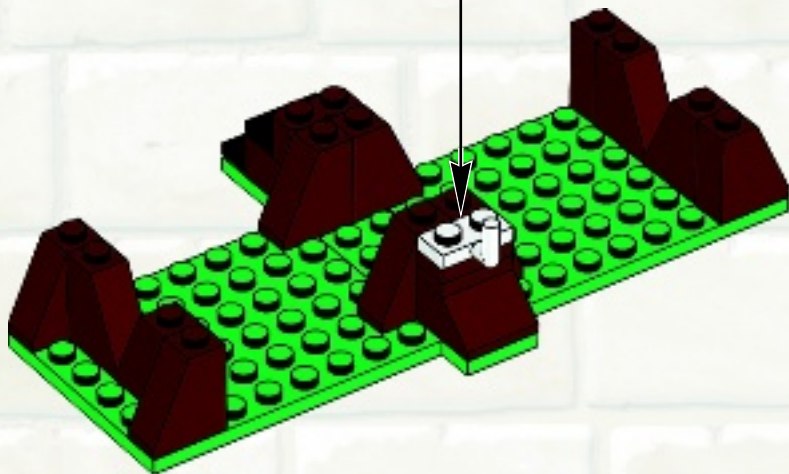
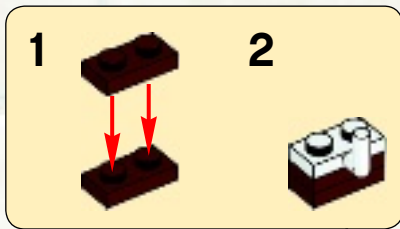



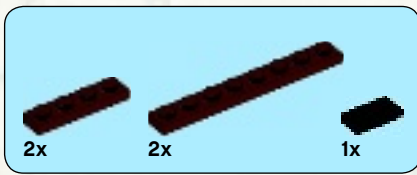

8

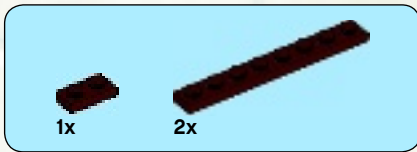
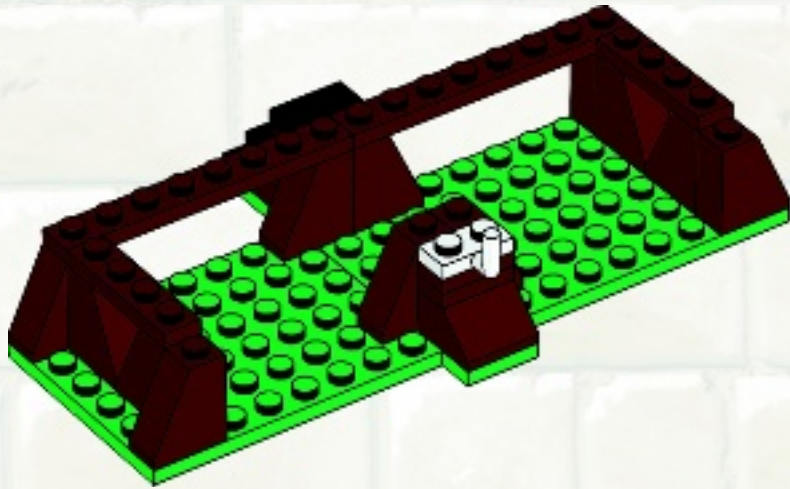

9

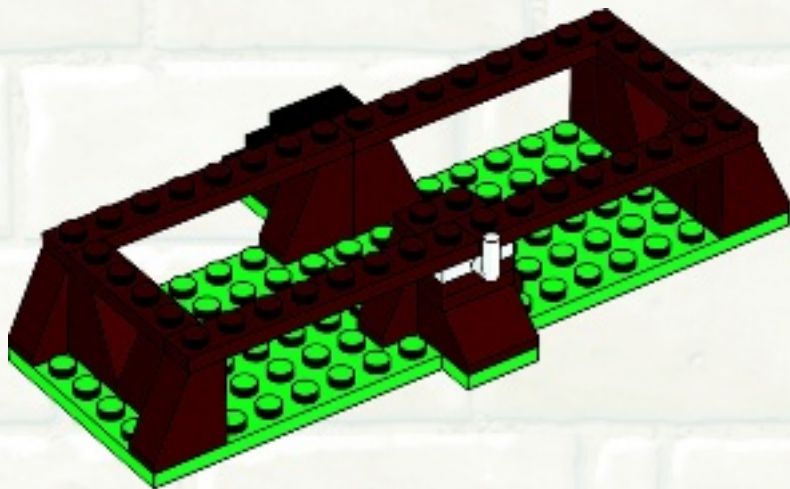



2x



3x



8x

# 10

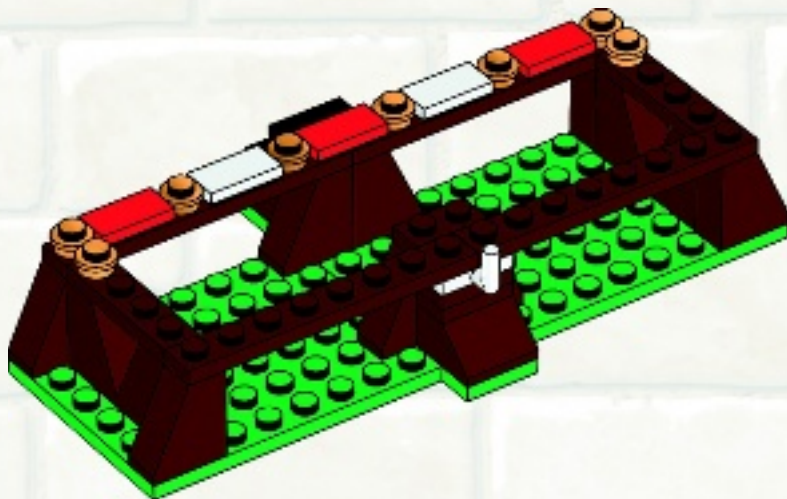

1x



2x



2x



8x

# 11

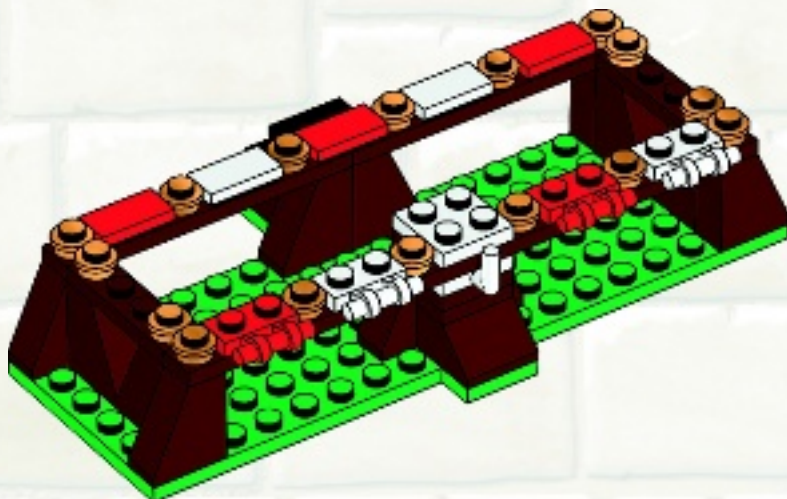

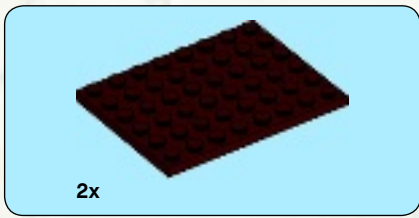

12

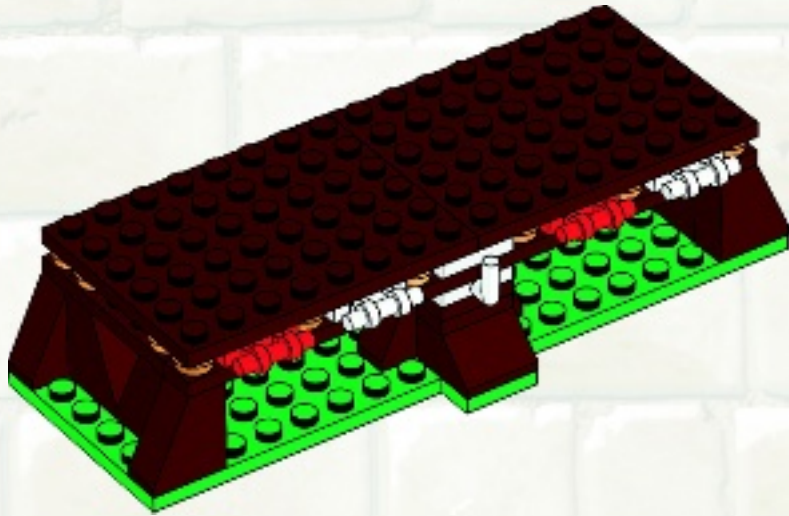

13

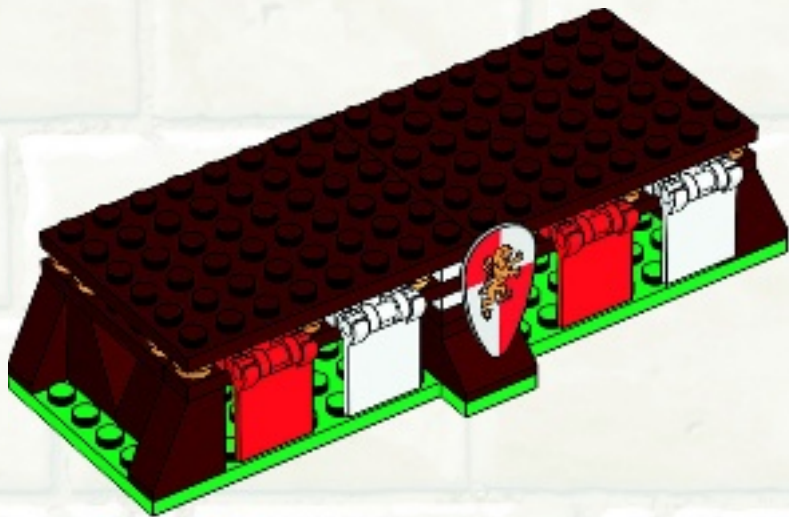



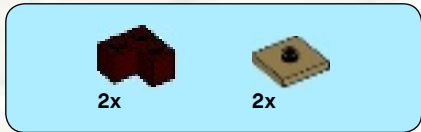

14

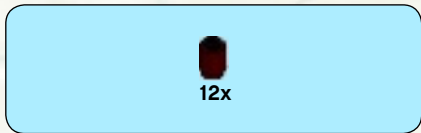
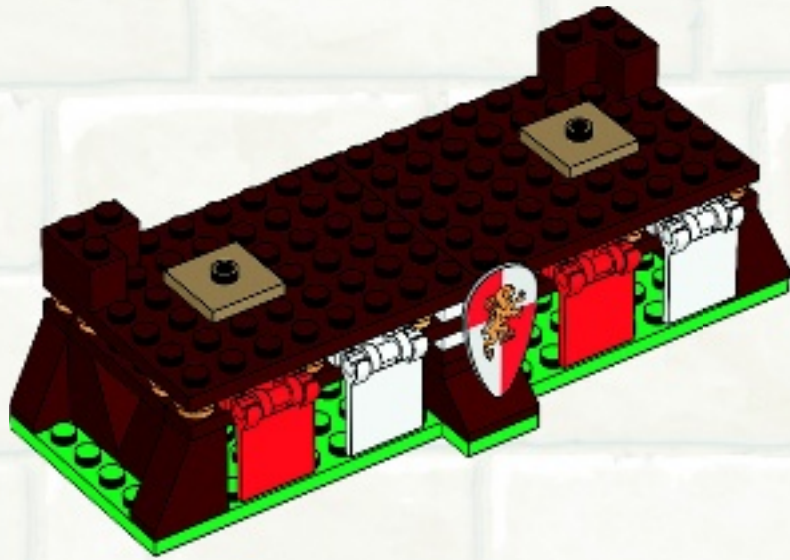

15

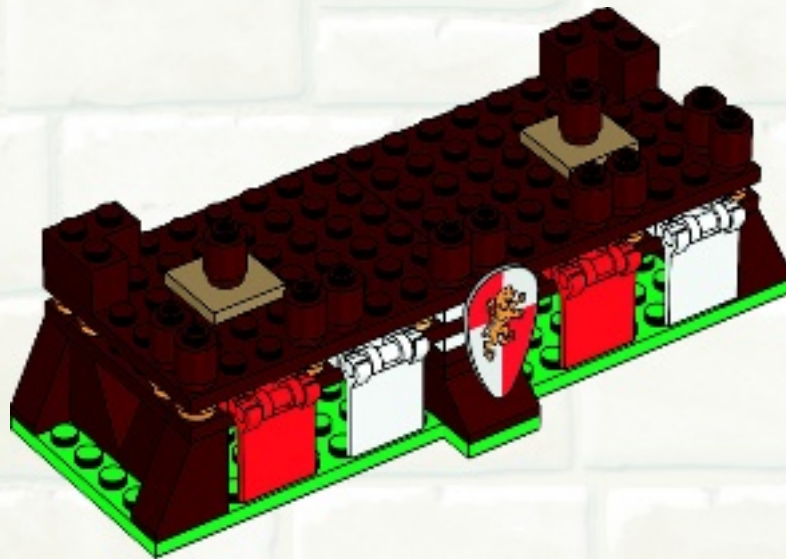

16x

# 16

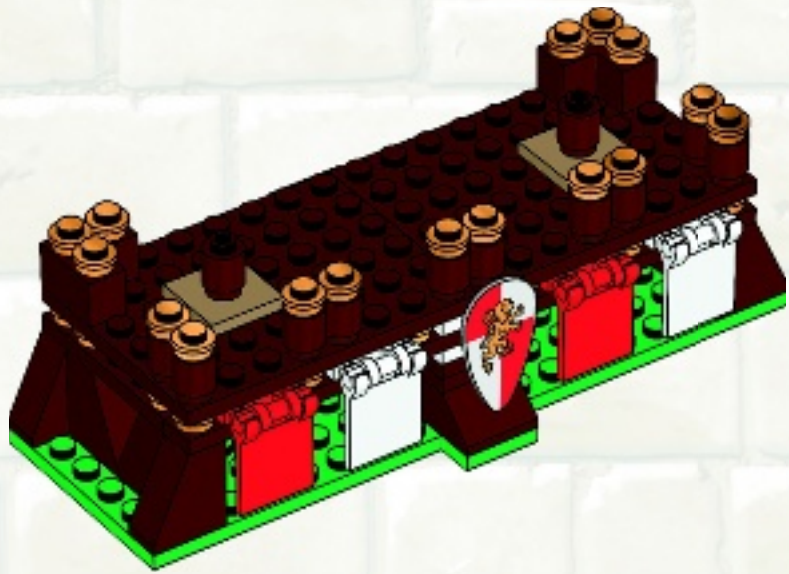

# 17



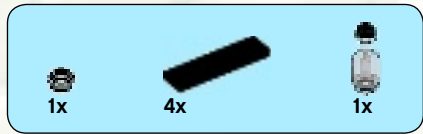

18

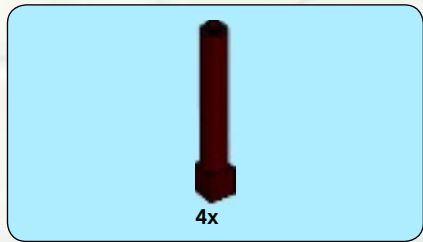

19

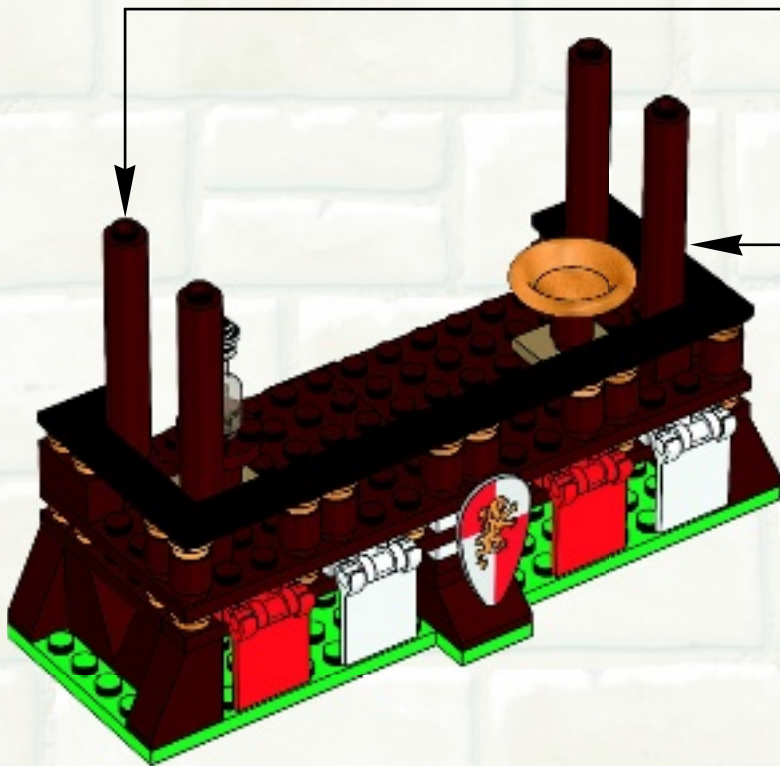
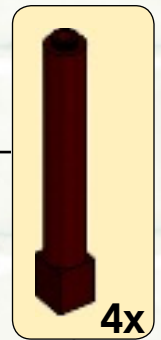





2x



2x

# 20



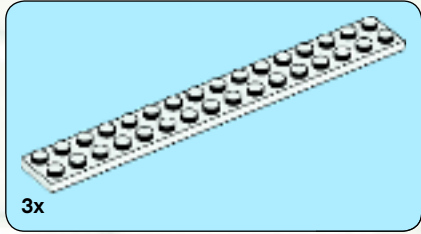
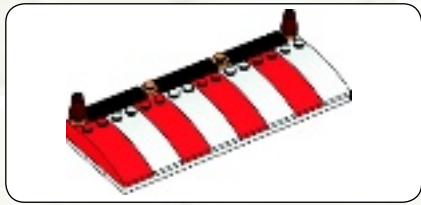

1

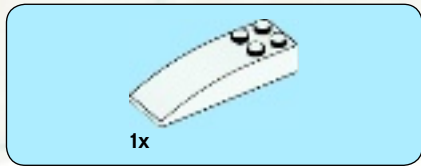
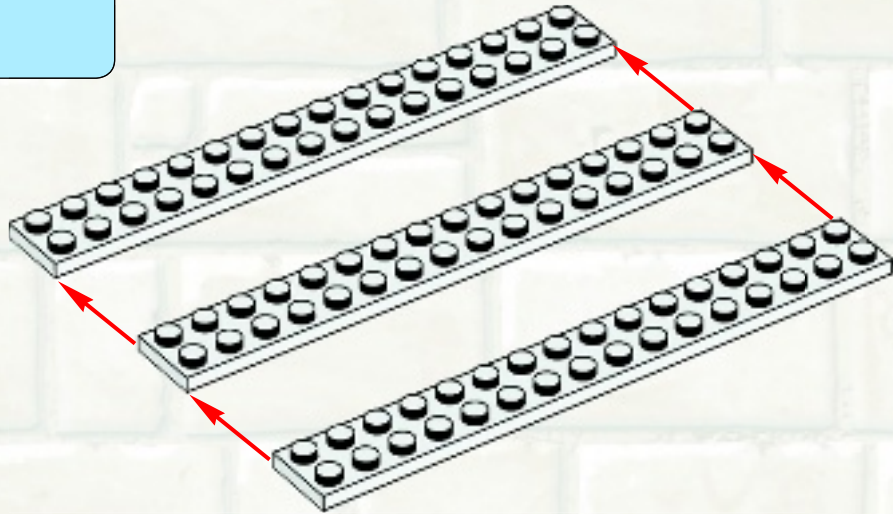

2

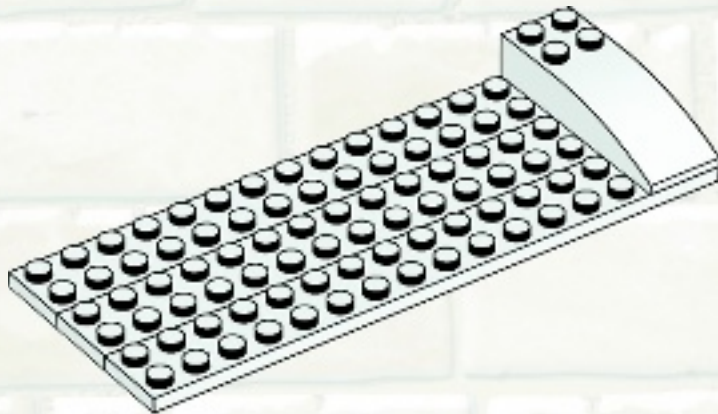

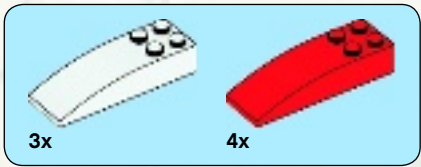

3

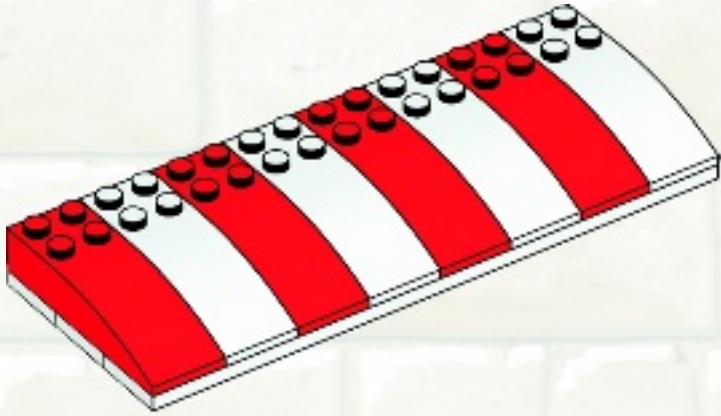

4

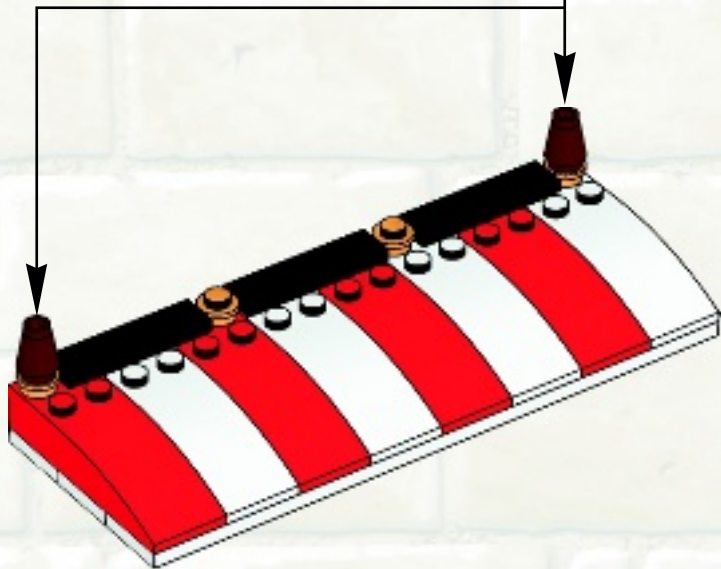





5

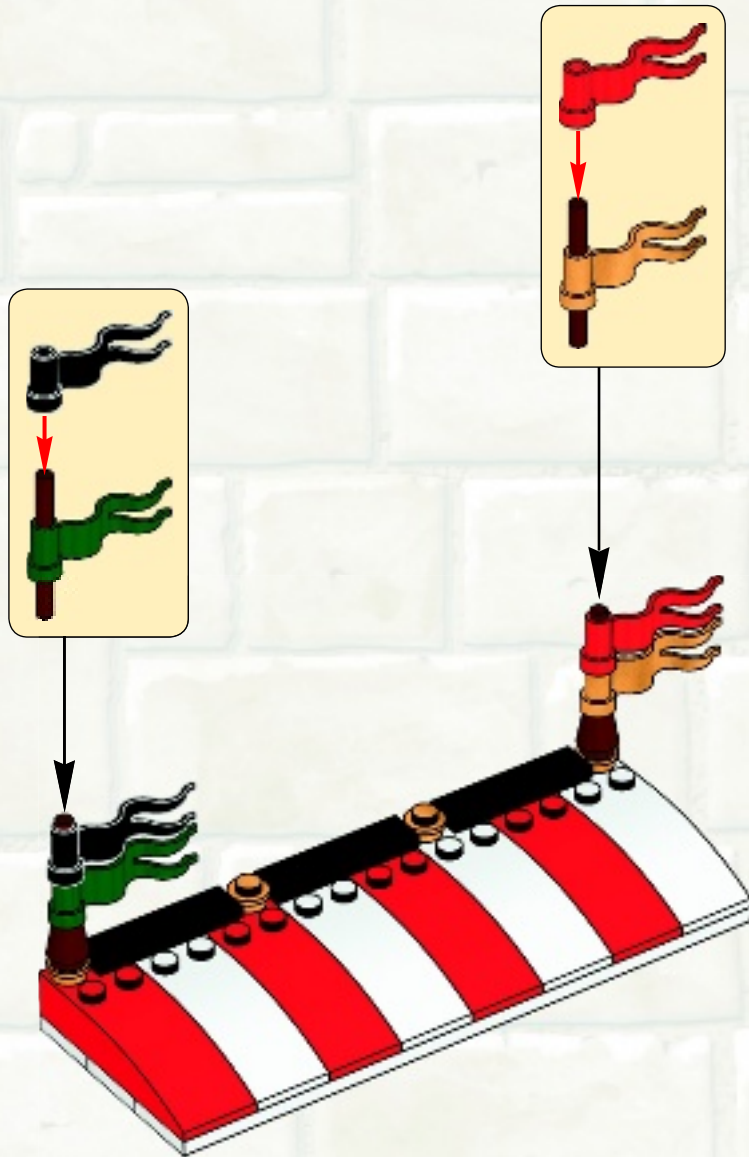

21



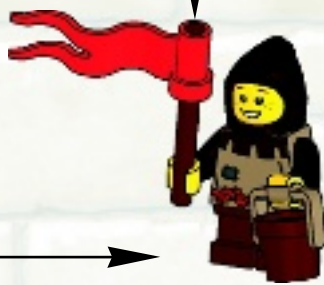
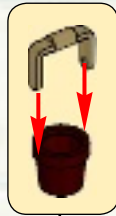
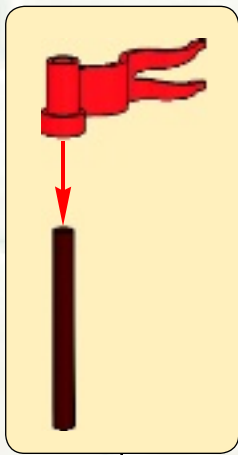
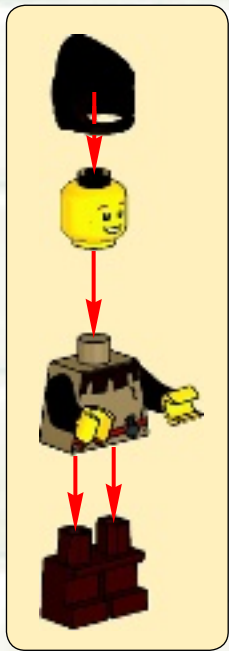
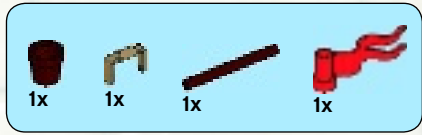
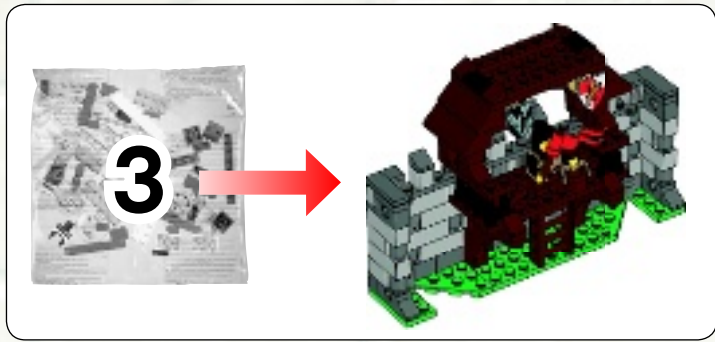



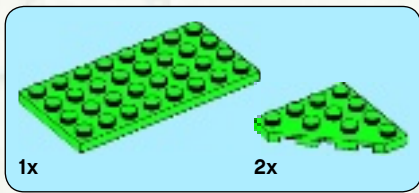

1

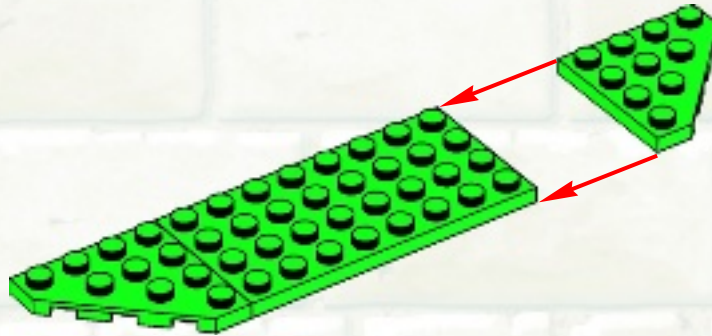

2

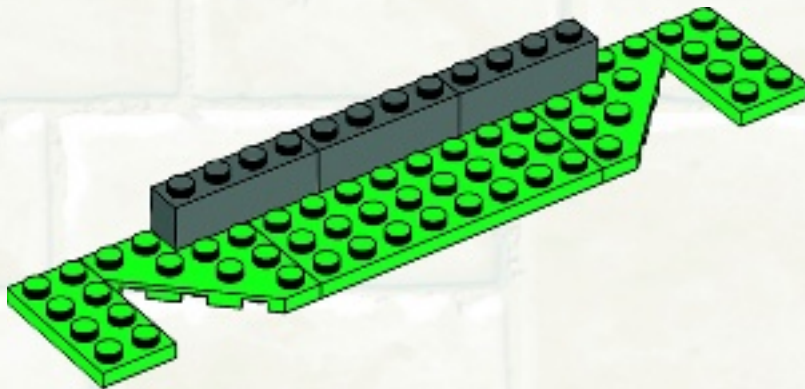



3

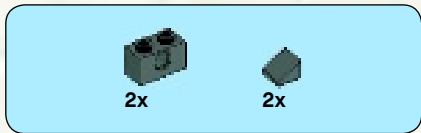
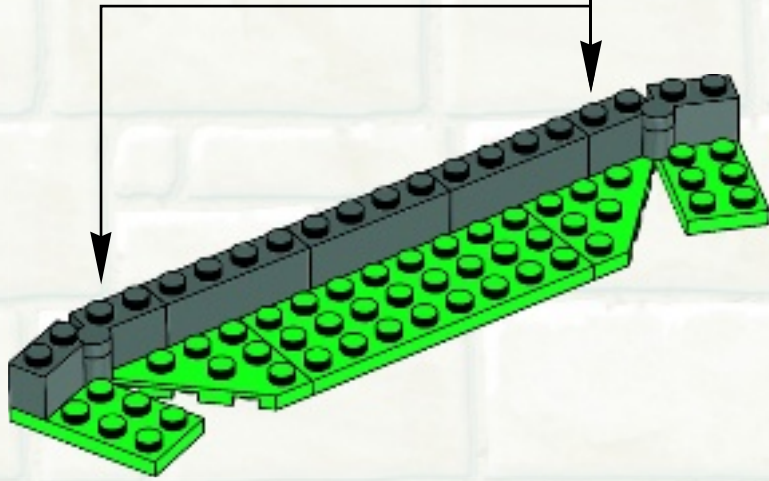
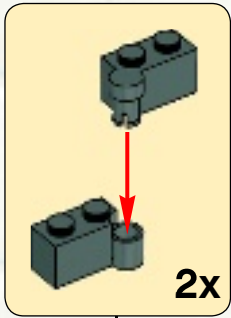

4

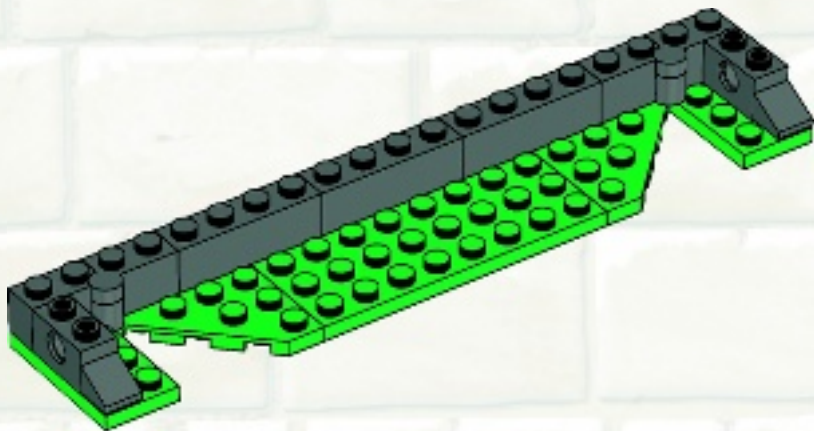



5

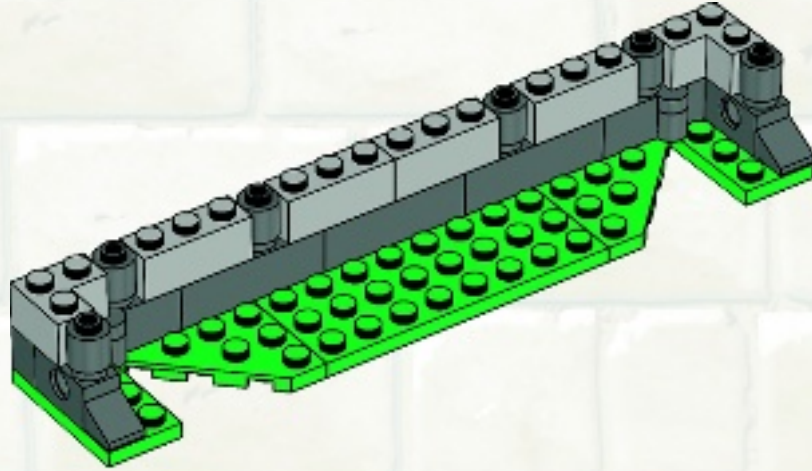

6

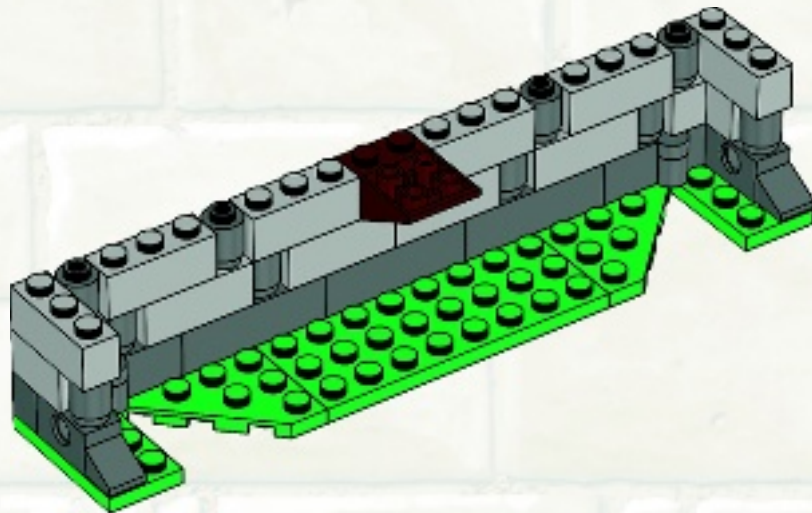





7

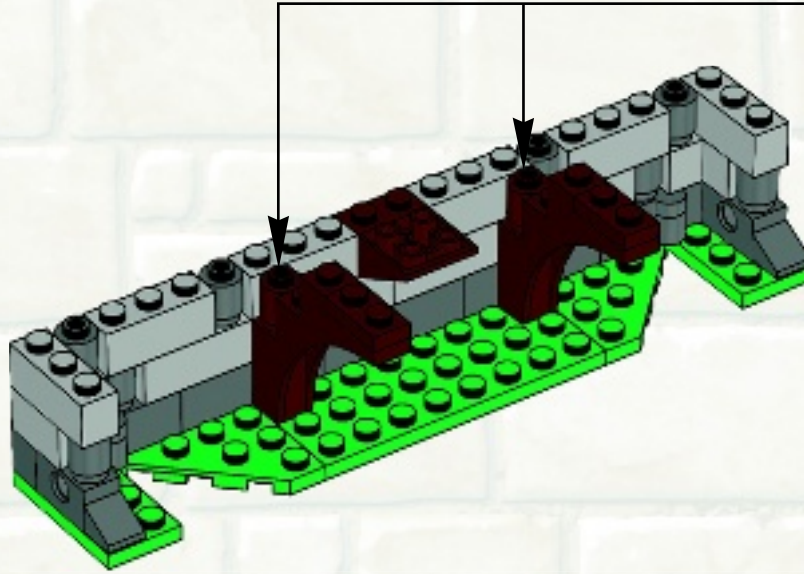
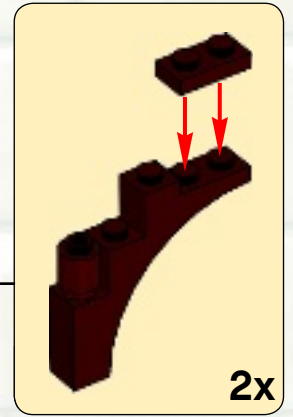

8

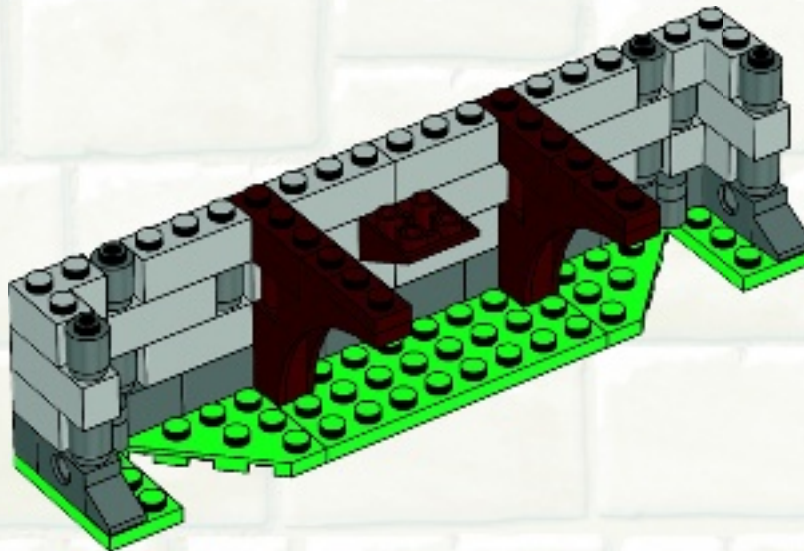

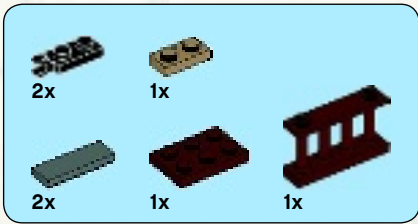

# 9

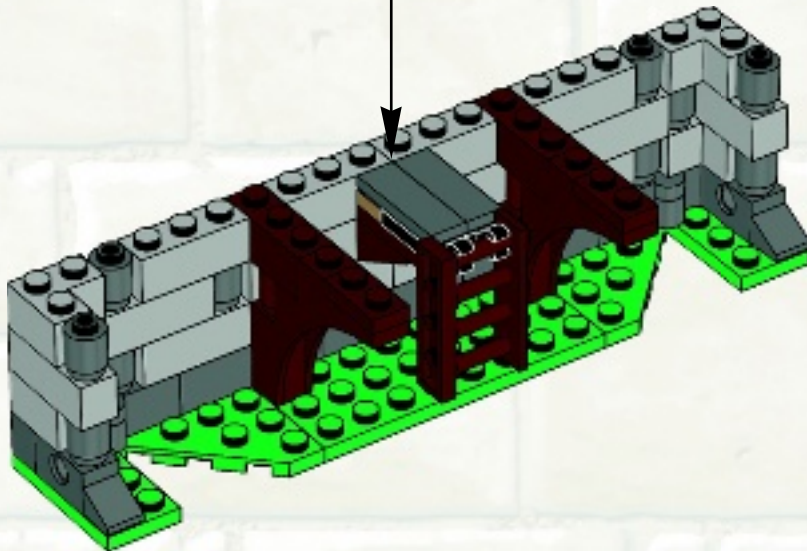
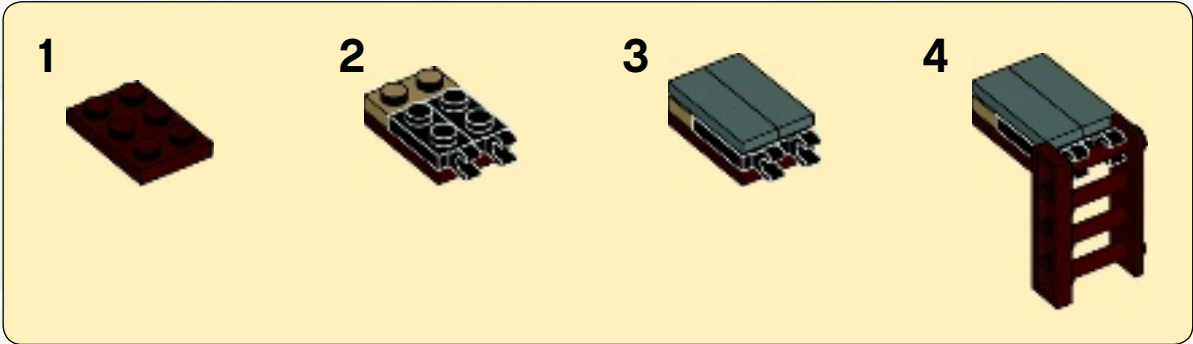



10

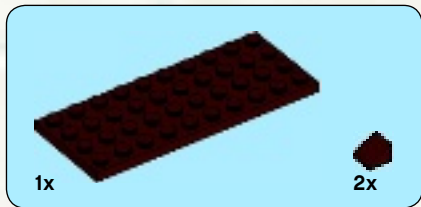
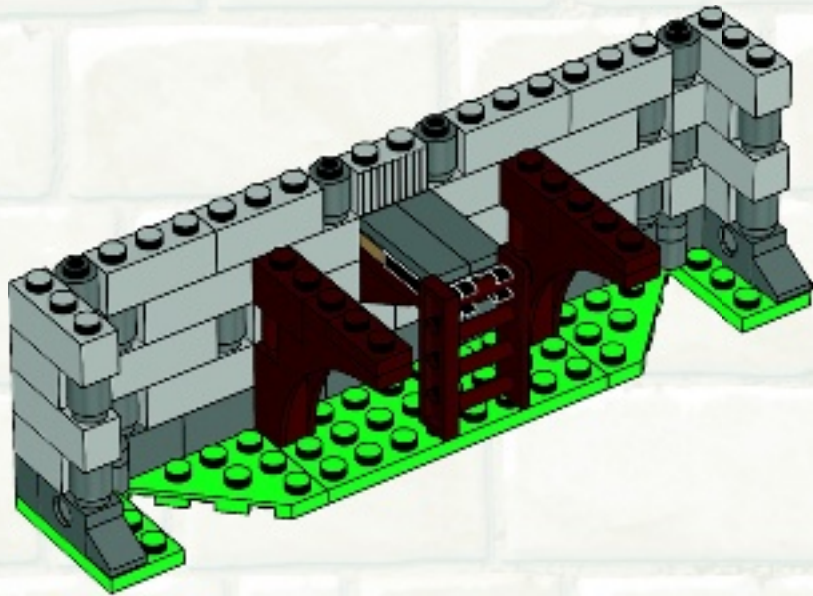

11

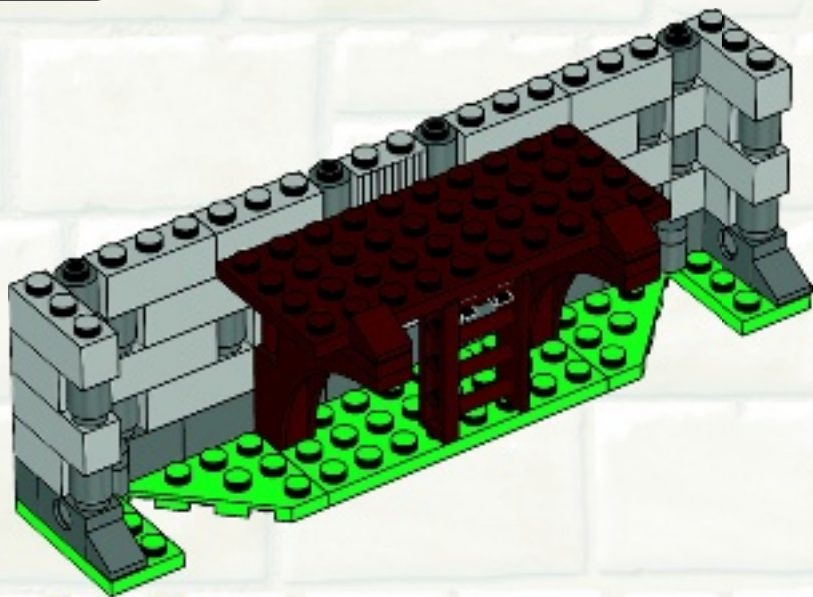



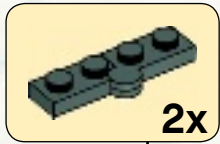
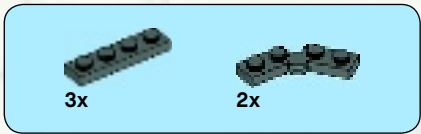

12

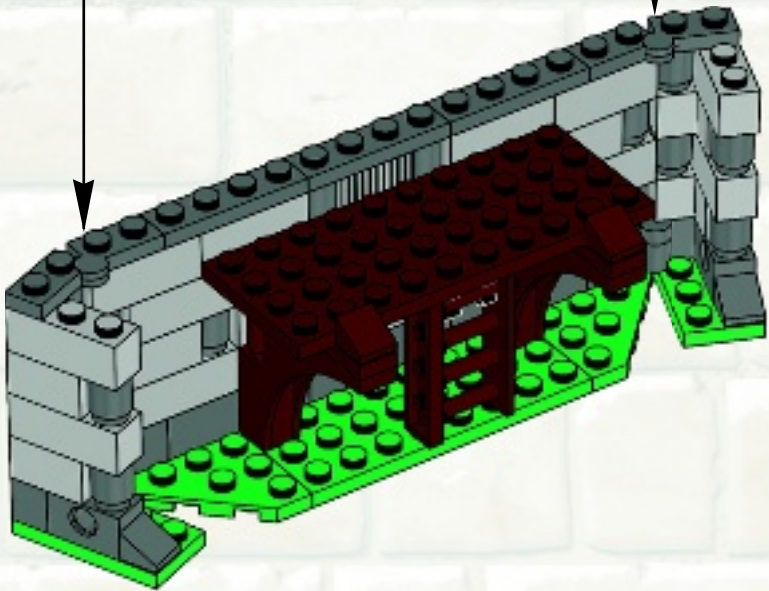

13

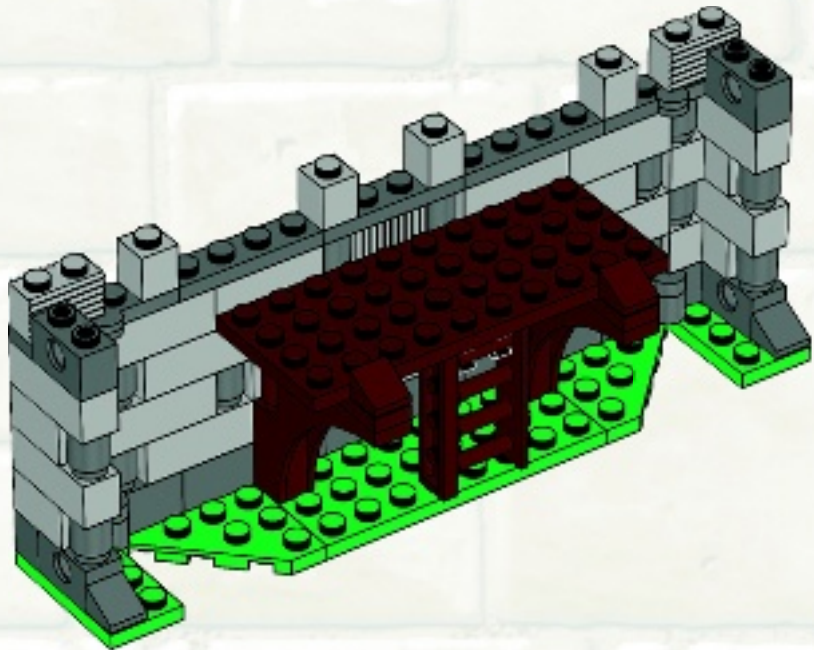

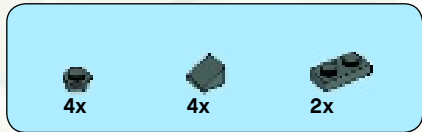

14

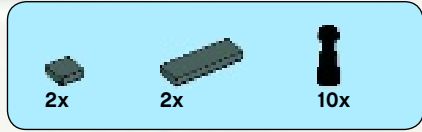
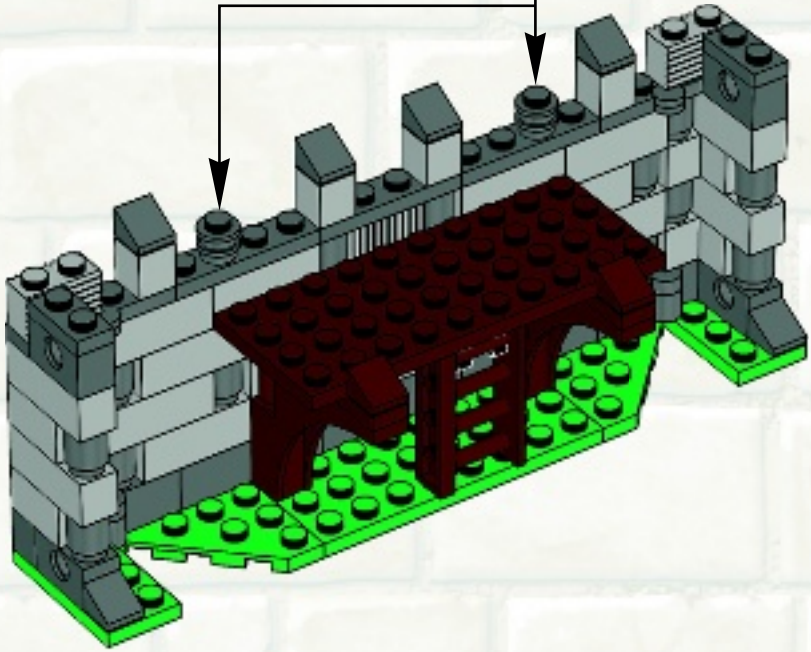
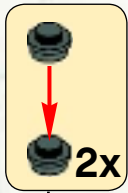

15

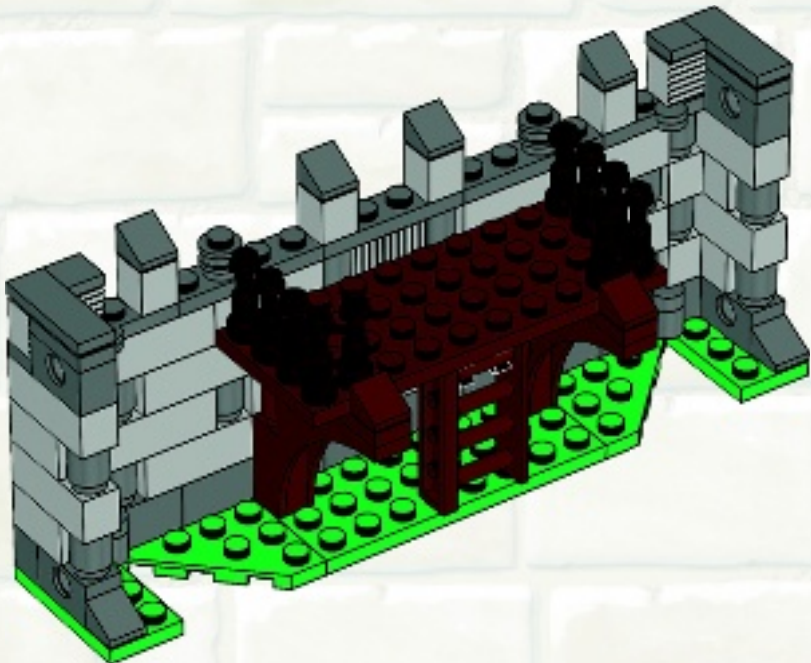



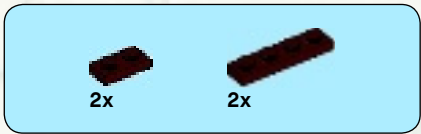

16

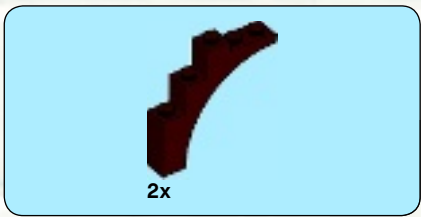
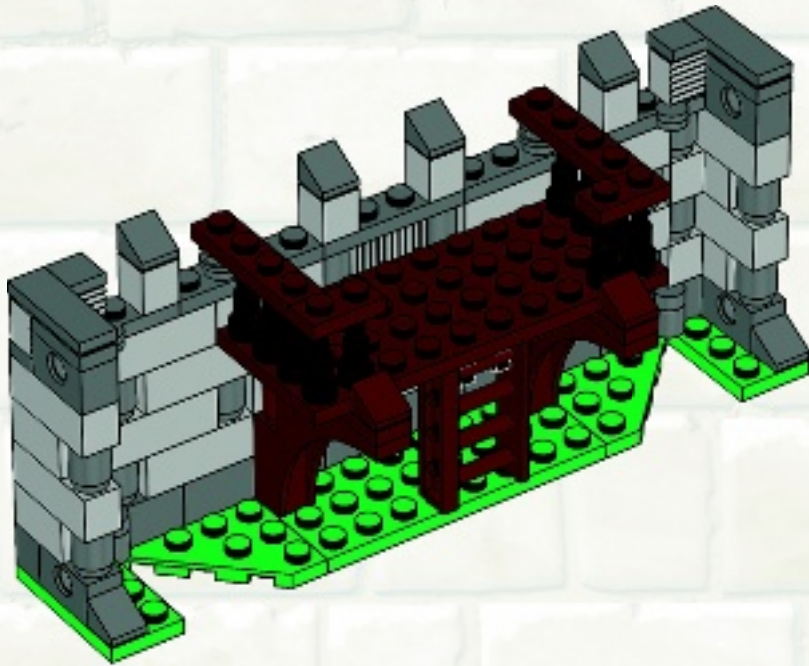

17

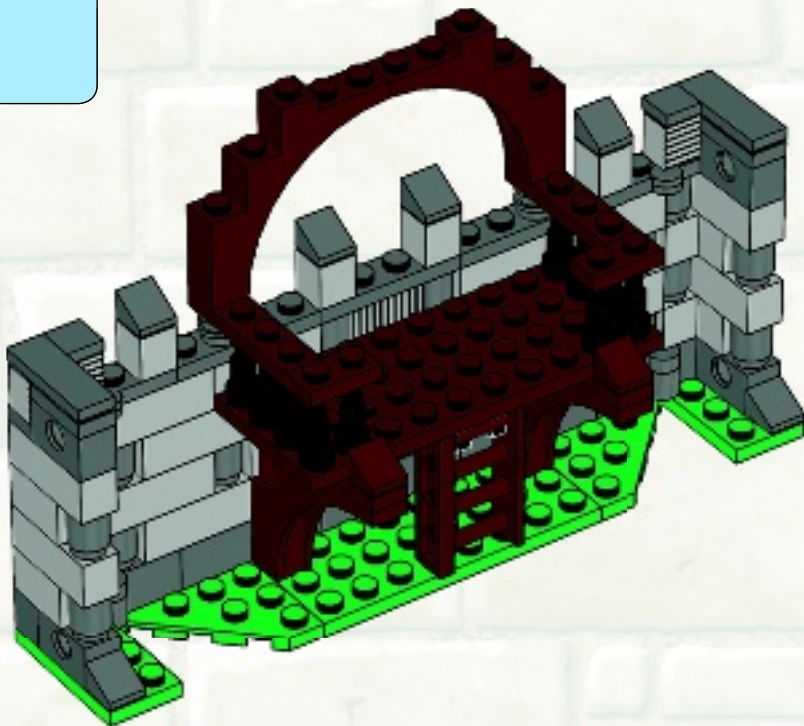



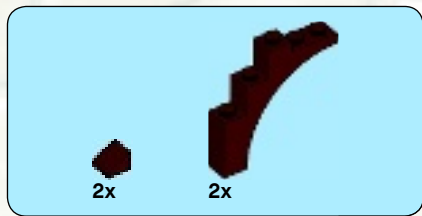

18

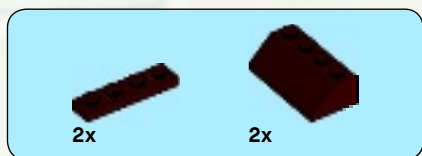
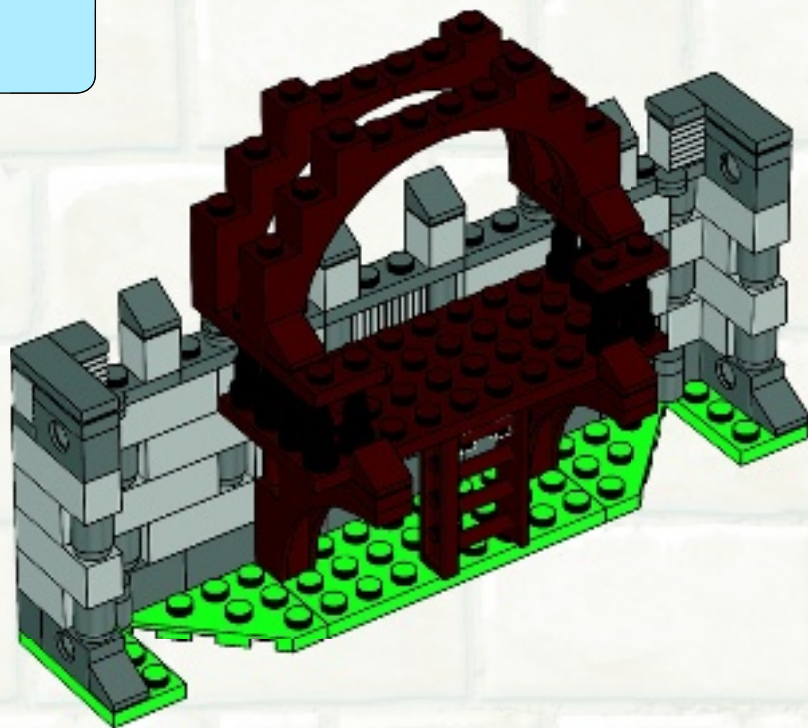

19

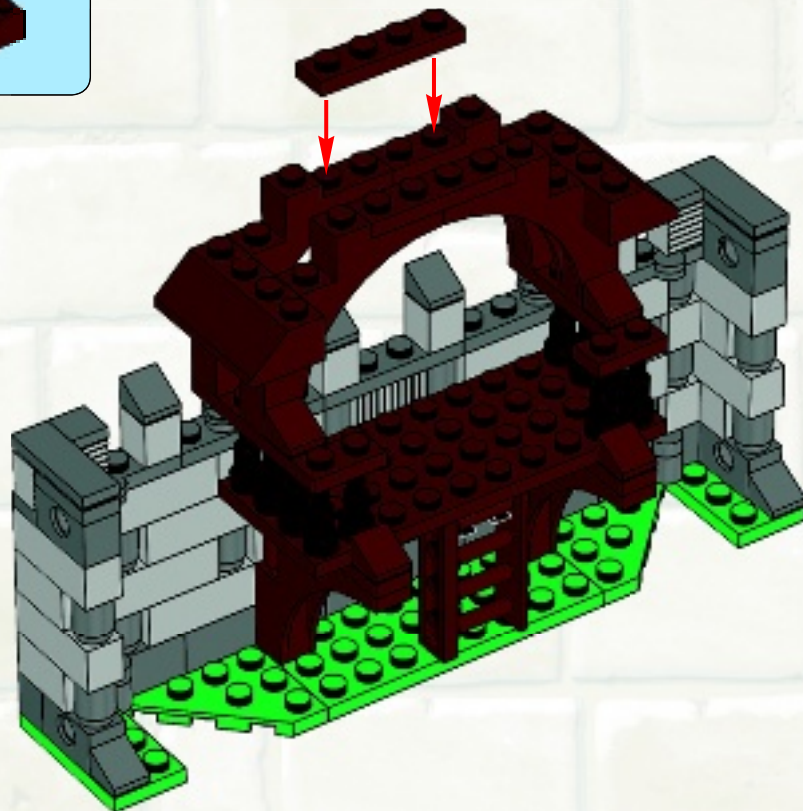

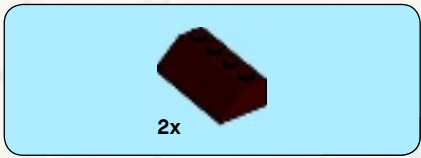

20

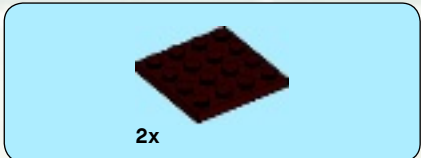
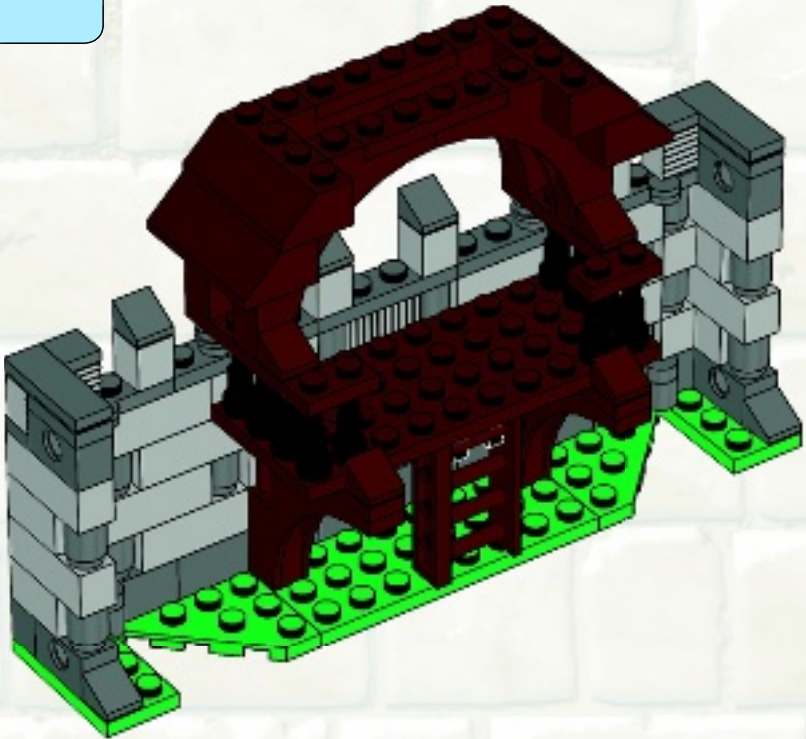

21

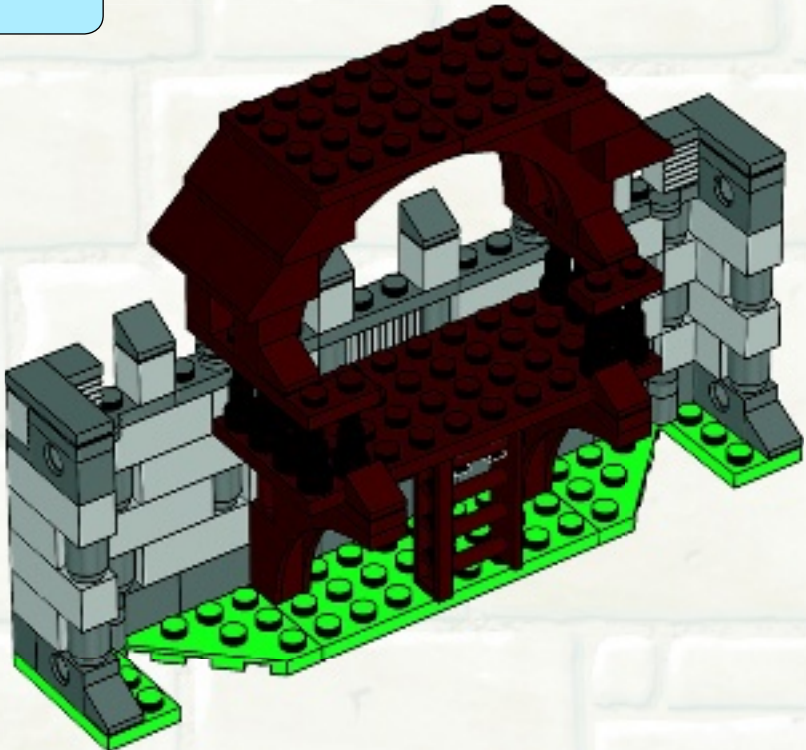



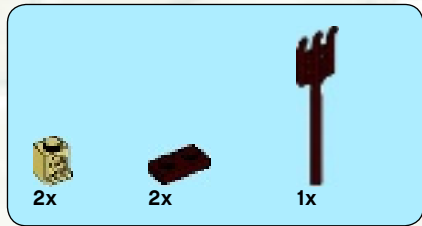

22

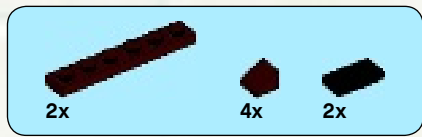

23

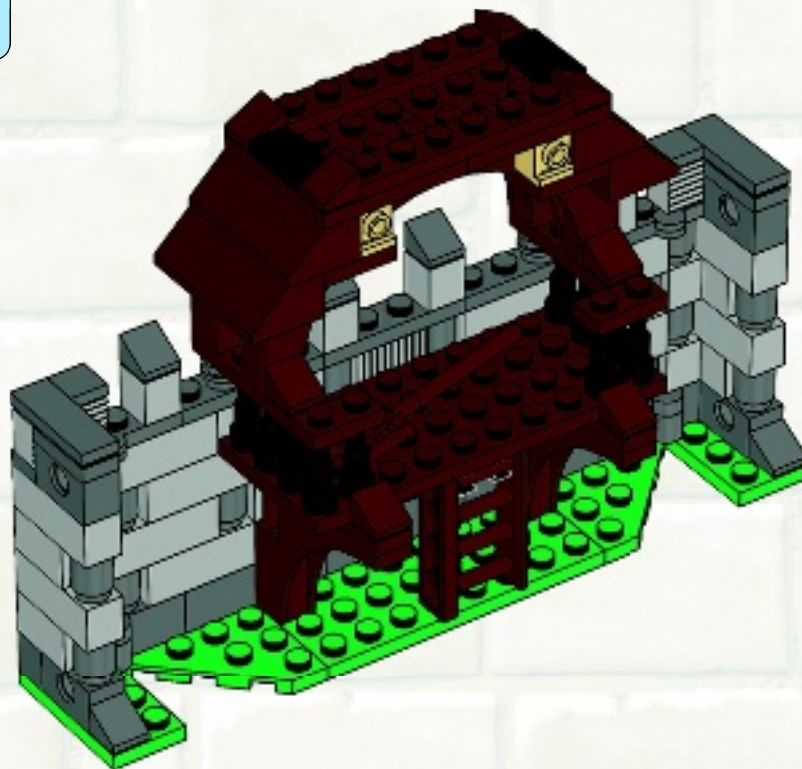





1x



1x

# 24

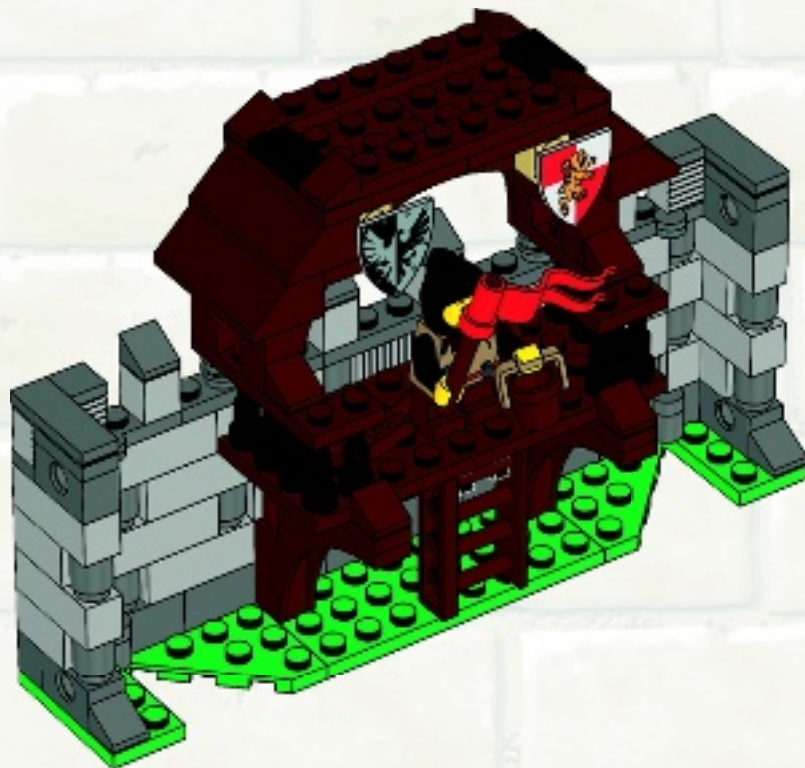

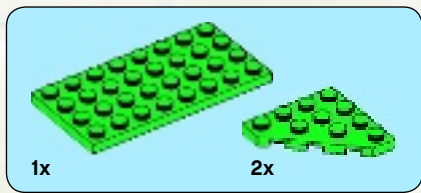
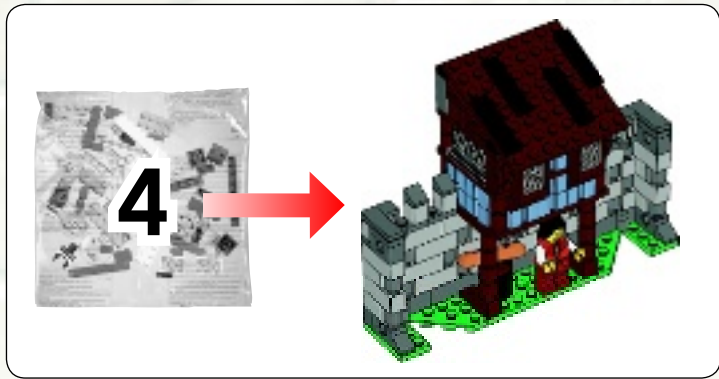

1

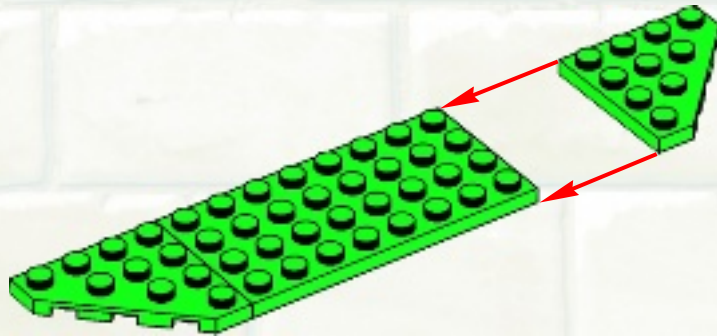

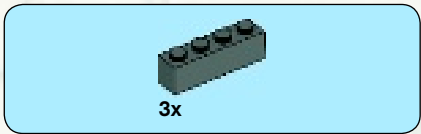

2

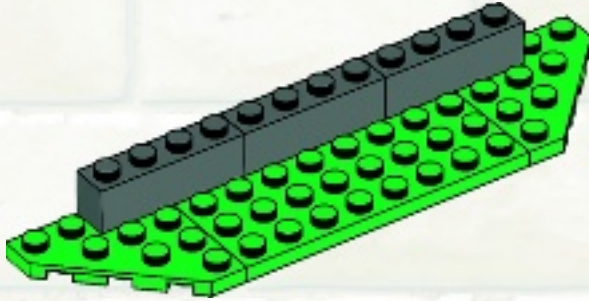

3

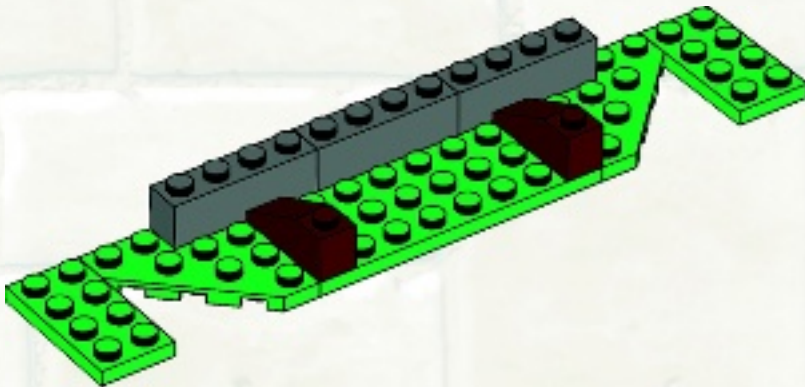





4

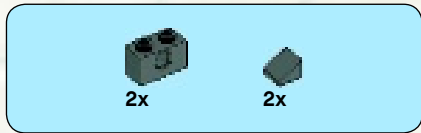
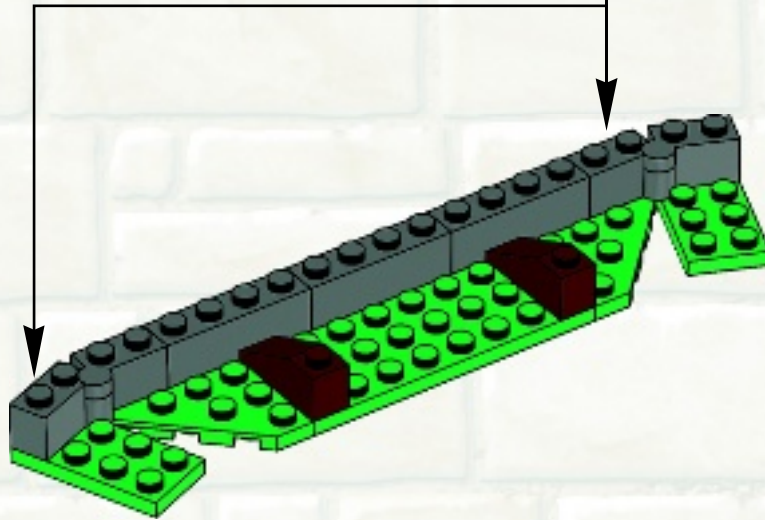
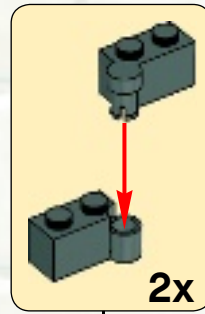

5

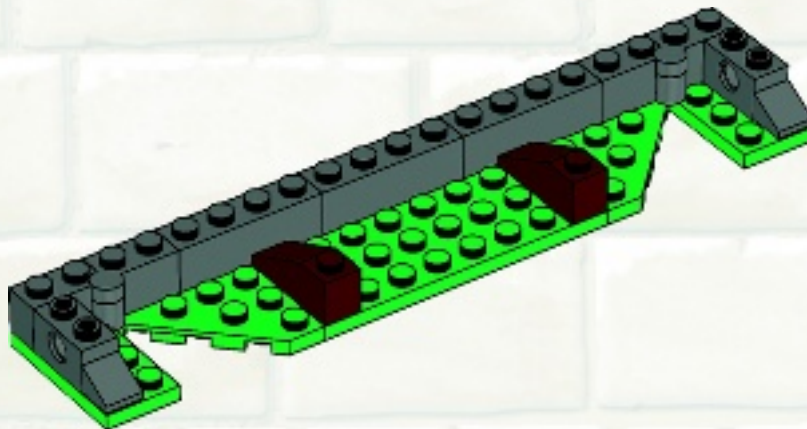



6

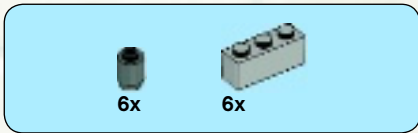
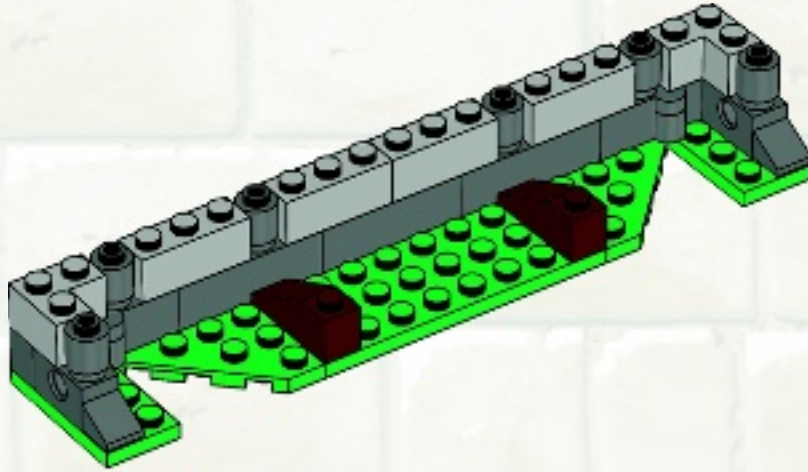

7

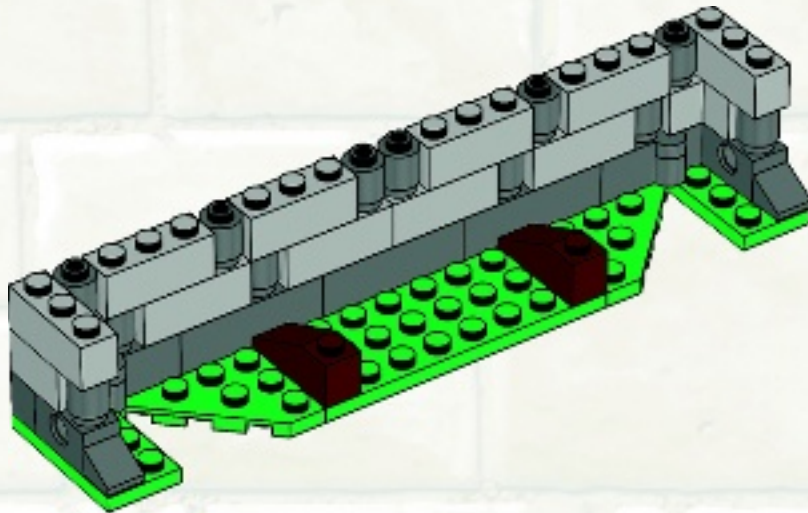



8

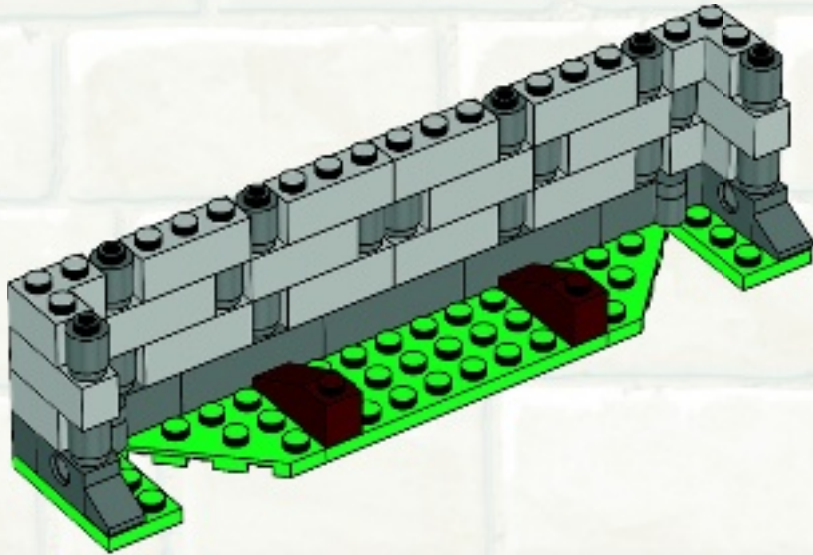

9

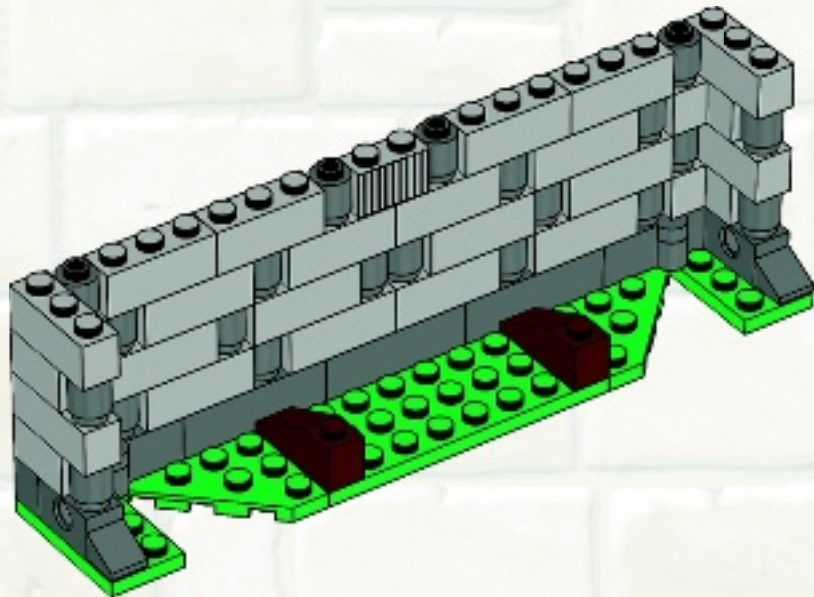



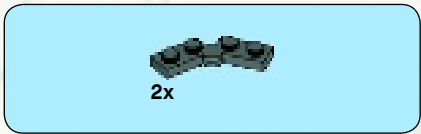

10

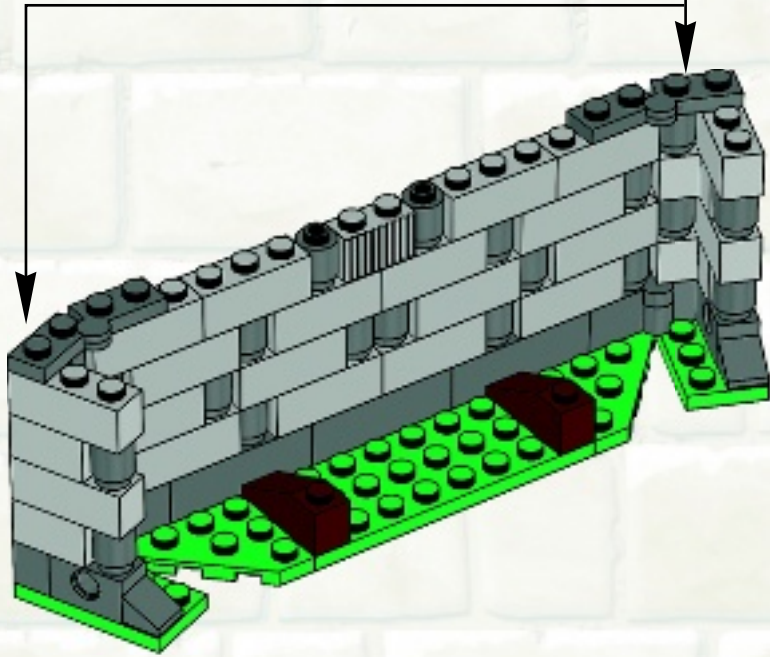
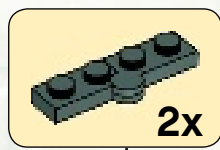

11

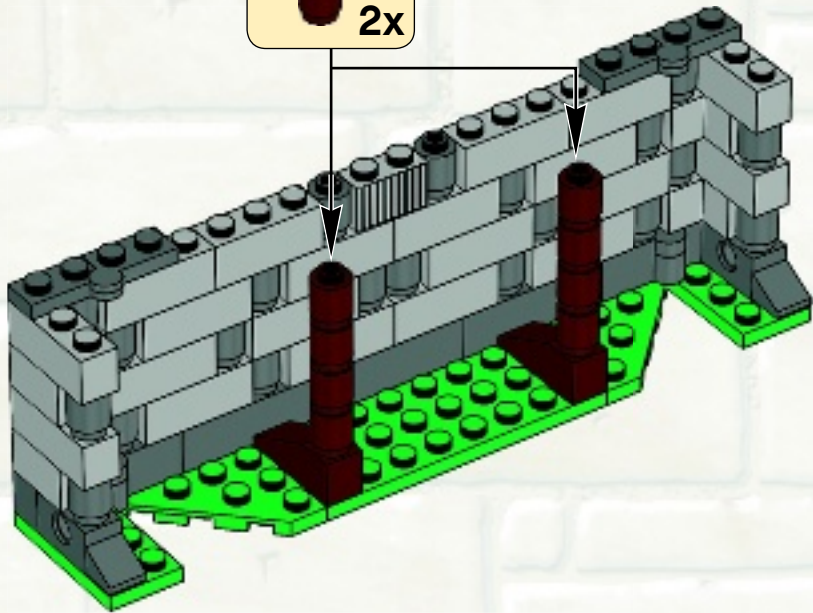
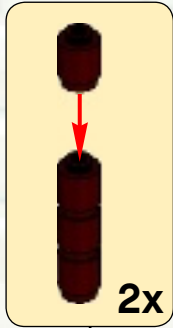

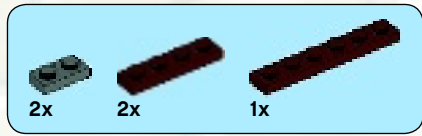

12

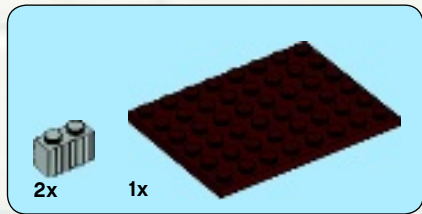
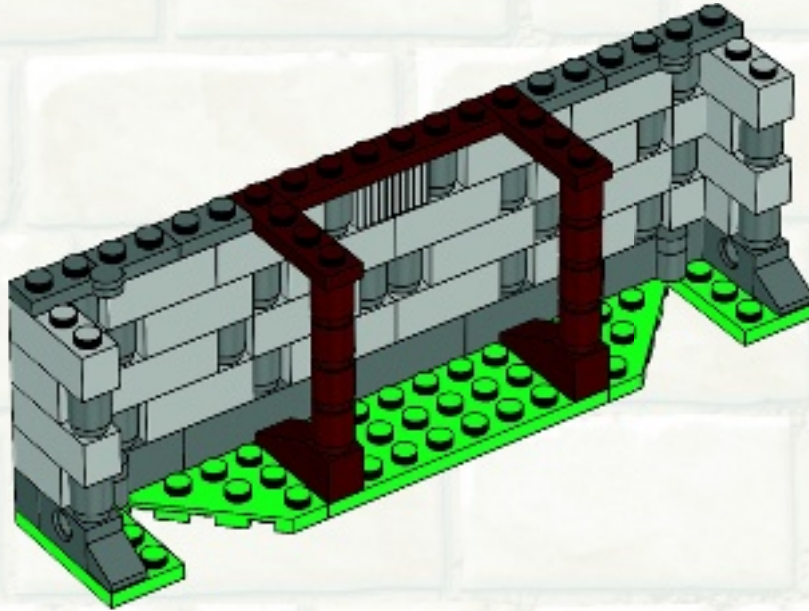

13

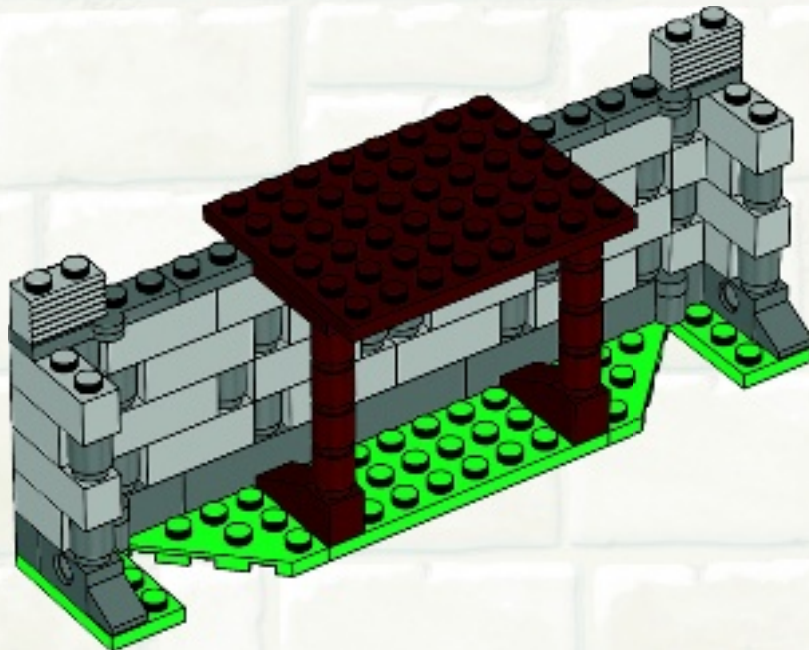



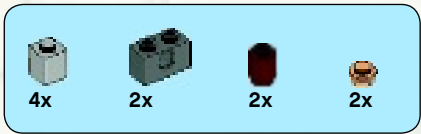

# 14

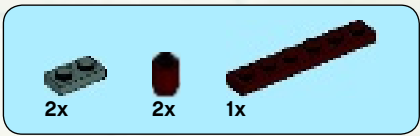
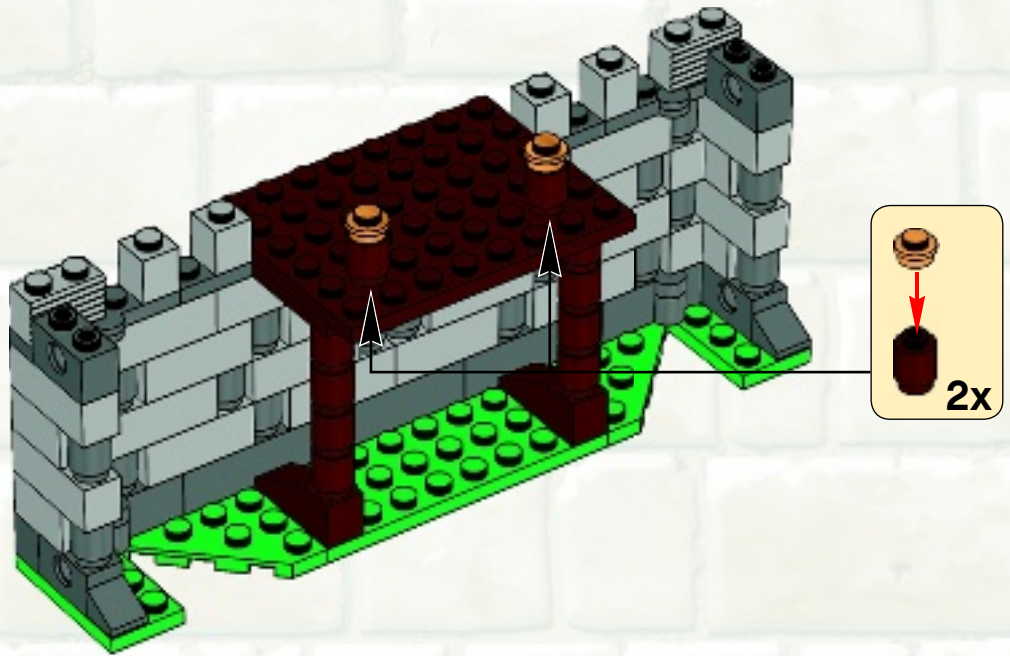

# 15

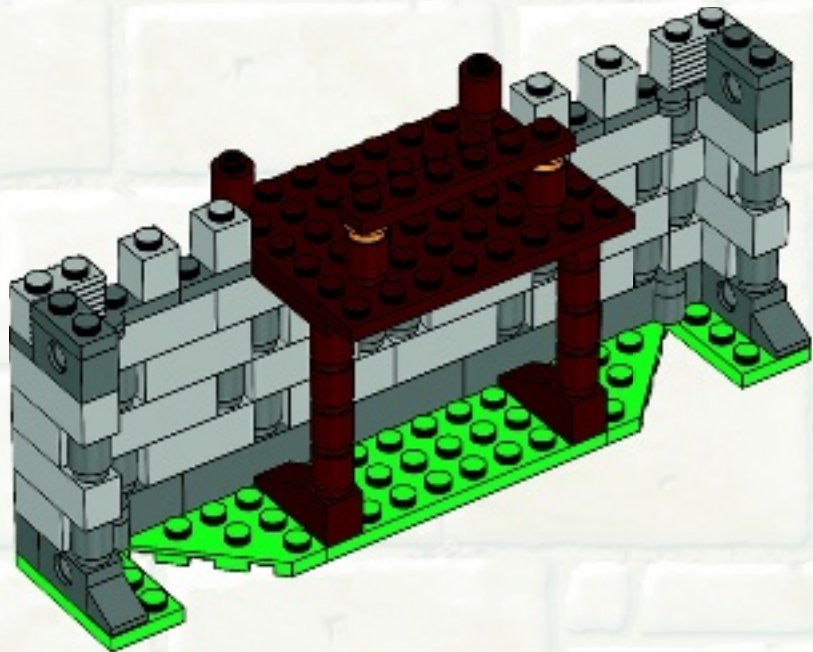





2x



7x

# 16

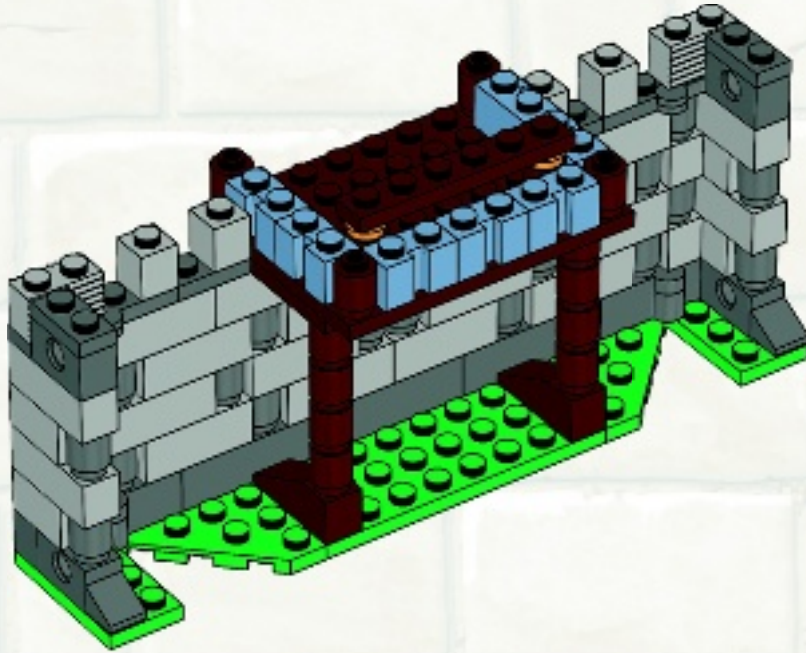

1x



2x



4x



2x



1x

# 17

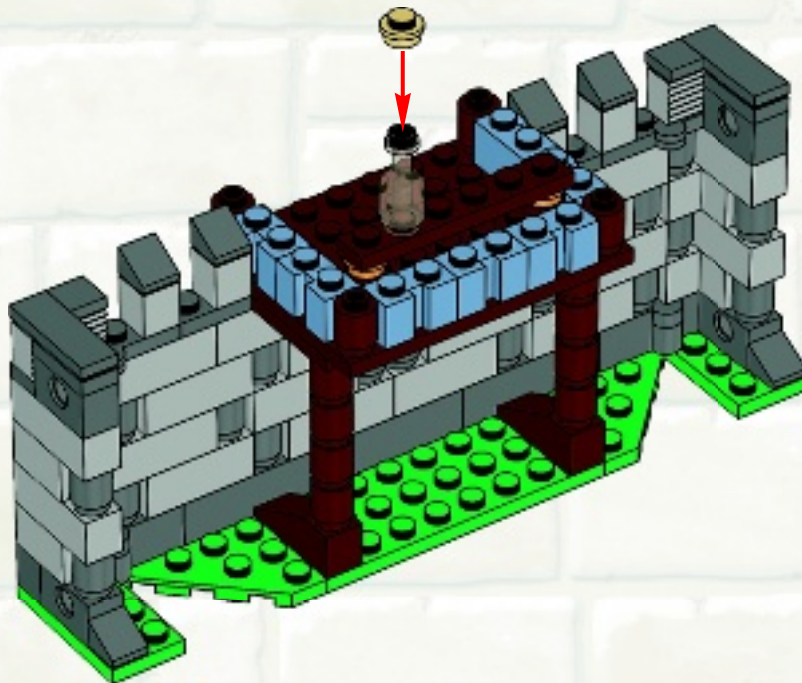

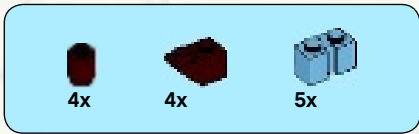

18

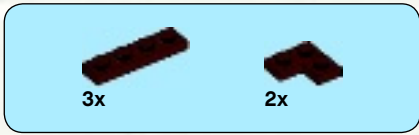
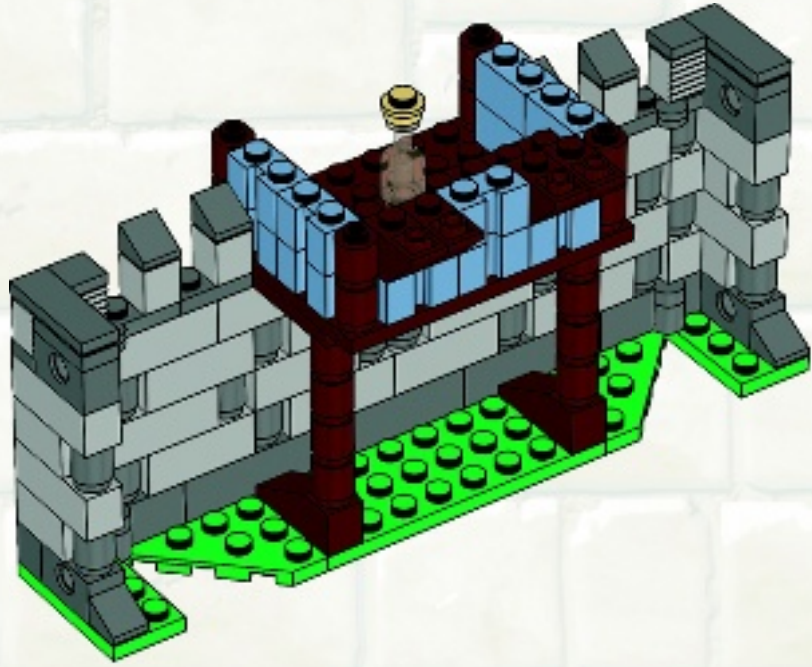

19

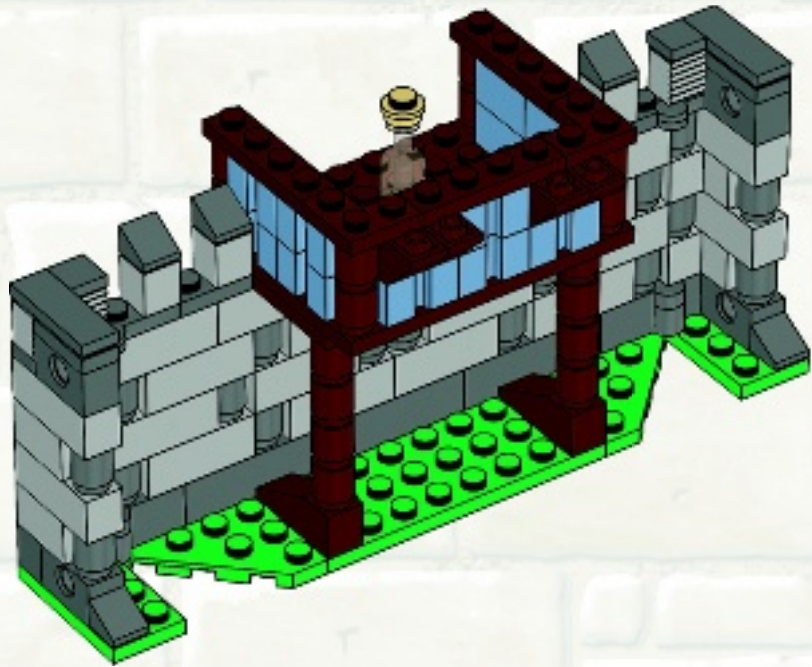

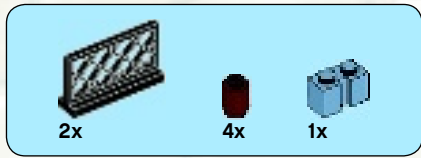

20

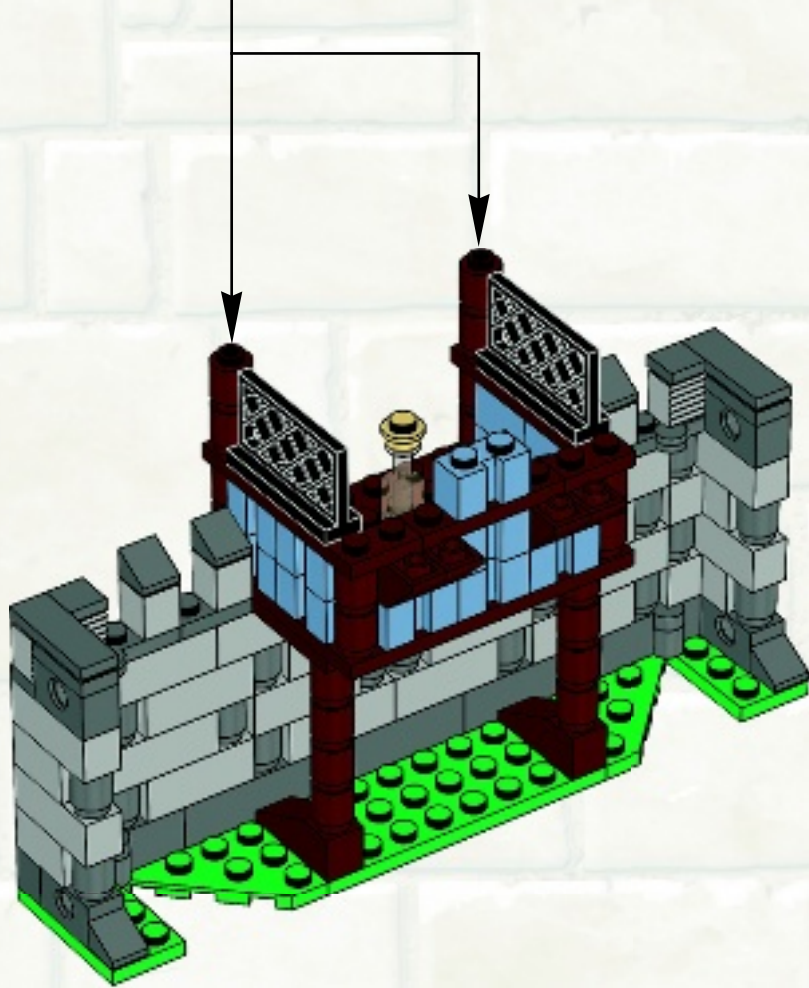
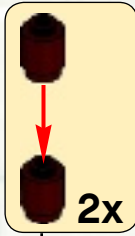





# 21

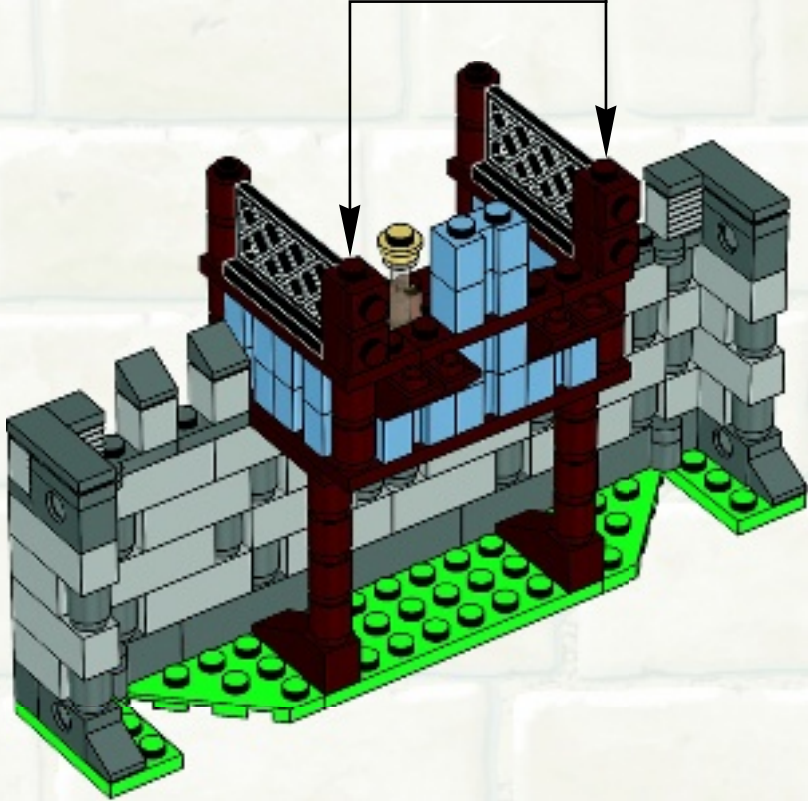
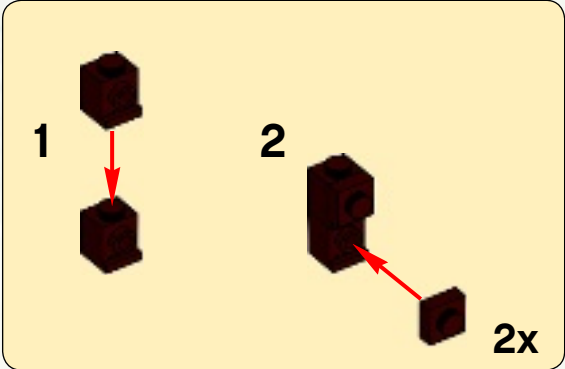



3x

22

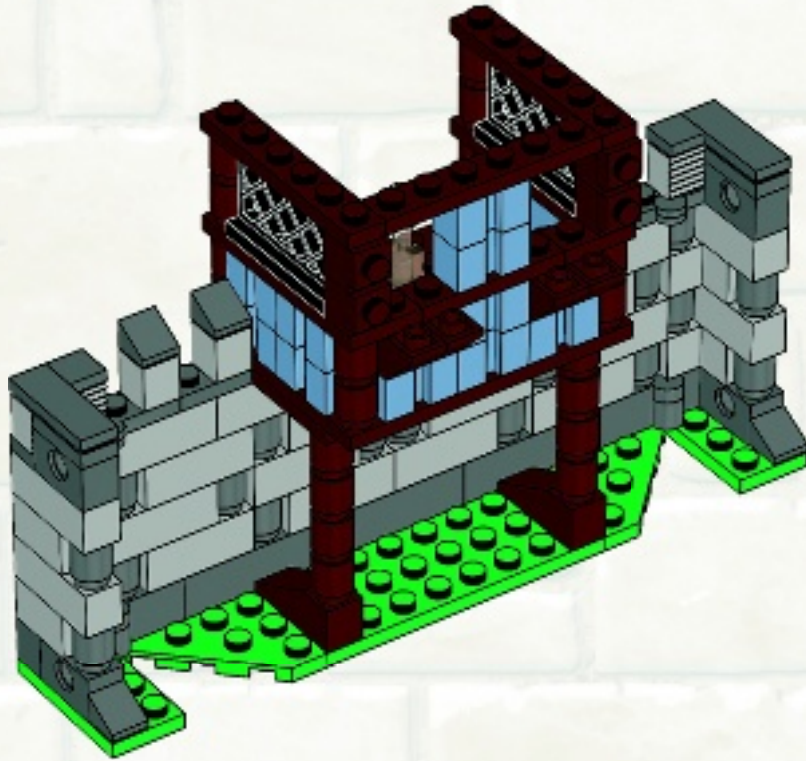

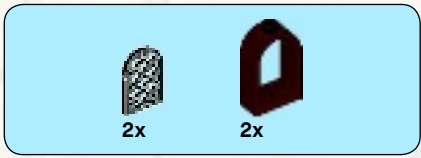

# 23

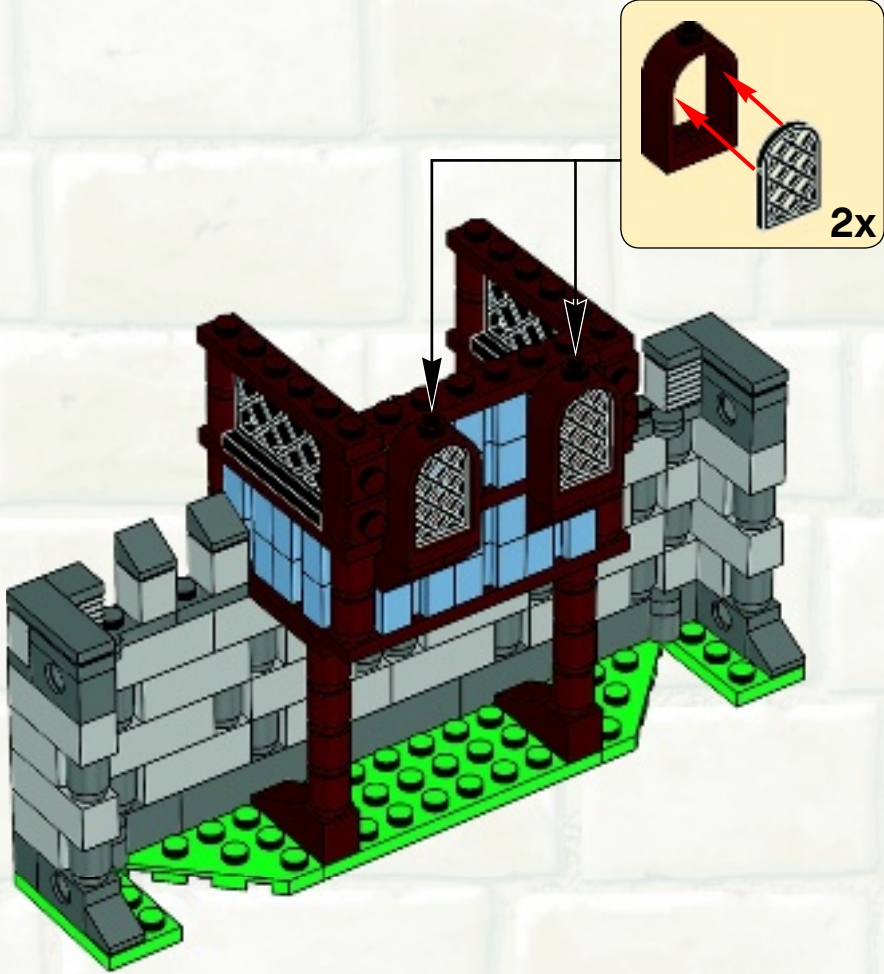



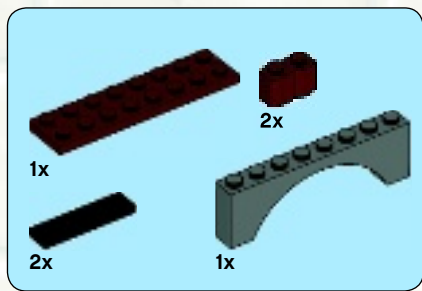

24

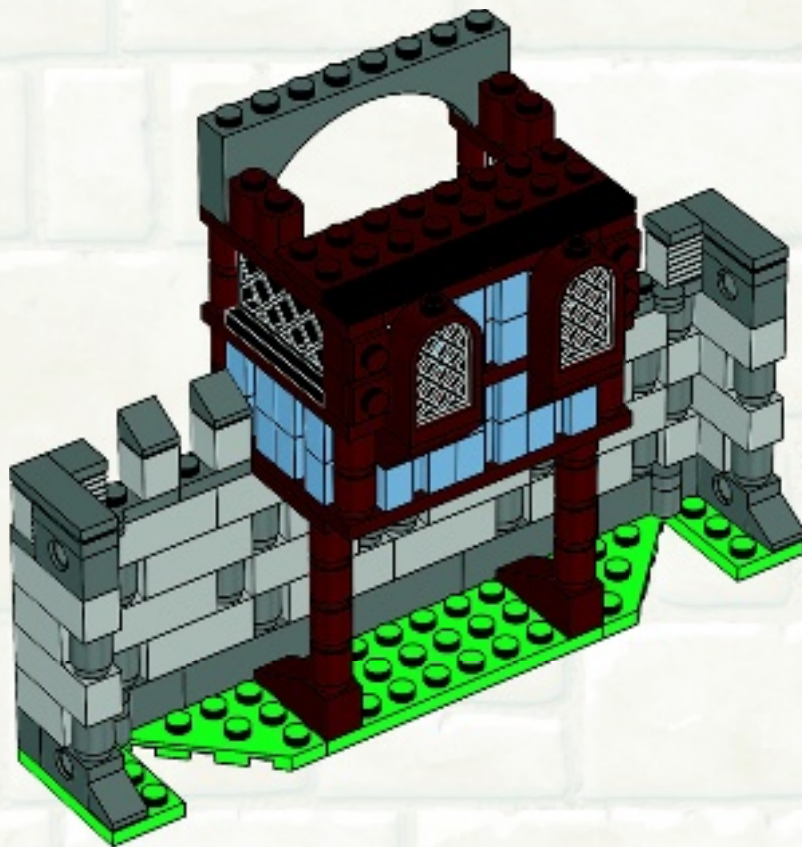



2x



4x

# 25

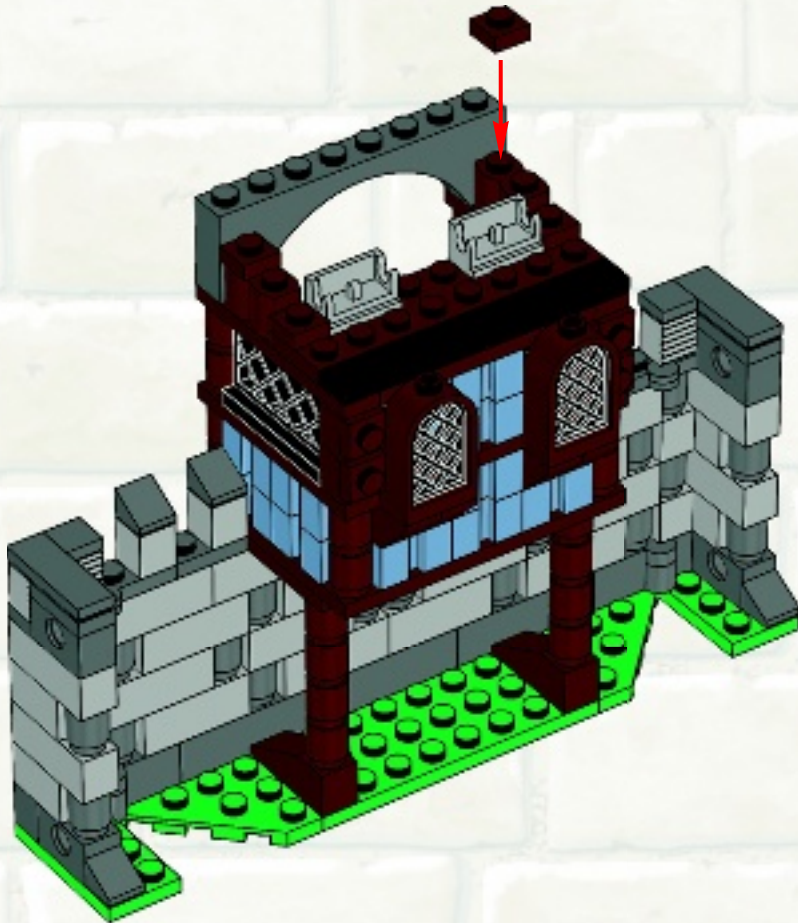



8x



2x

# 26

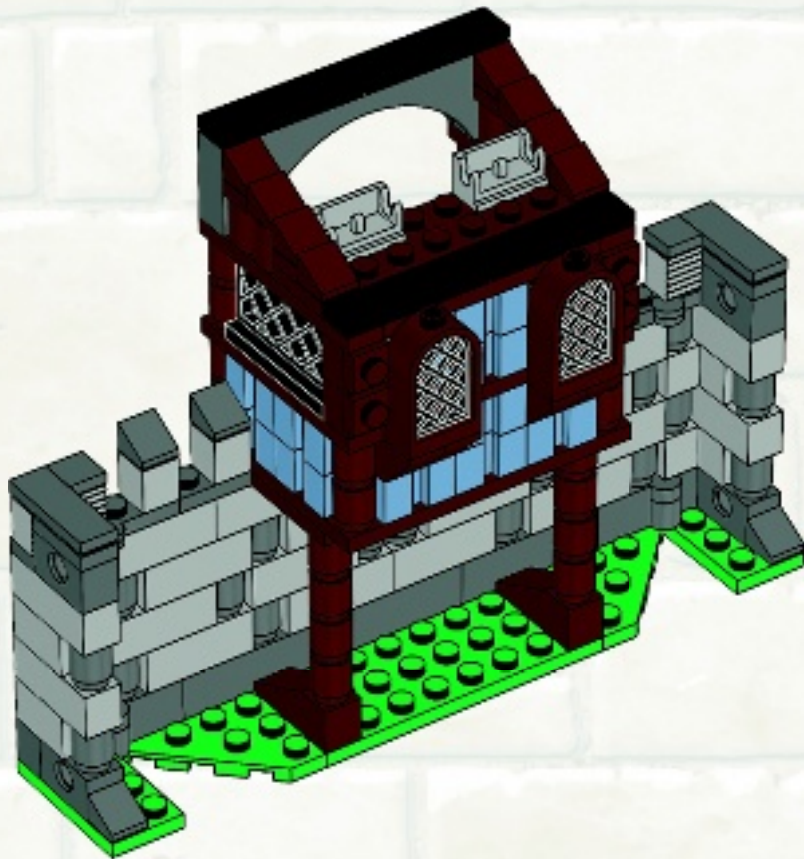



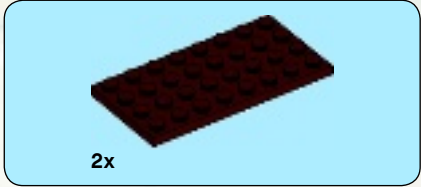
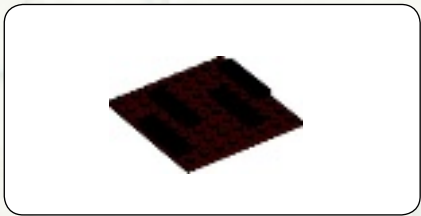

1

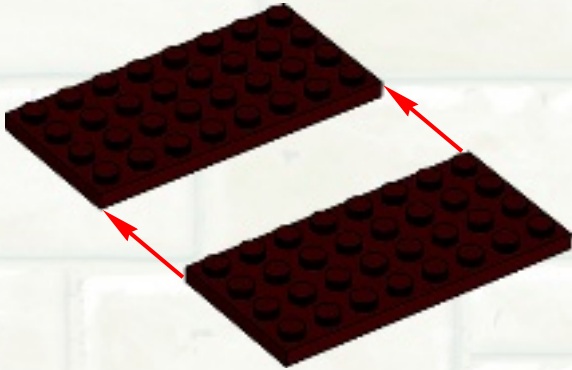

2



3

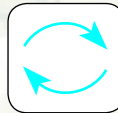

4

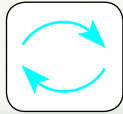

---

27

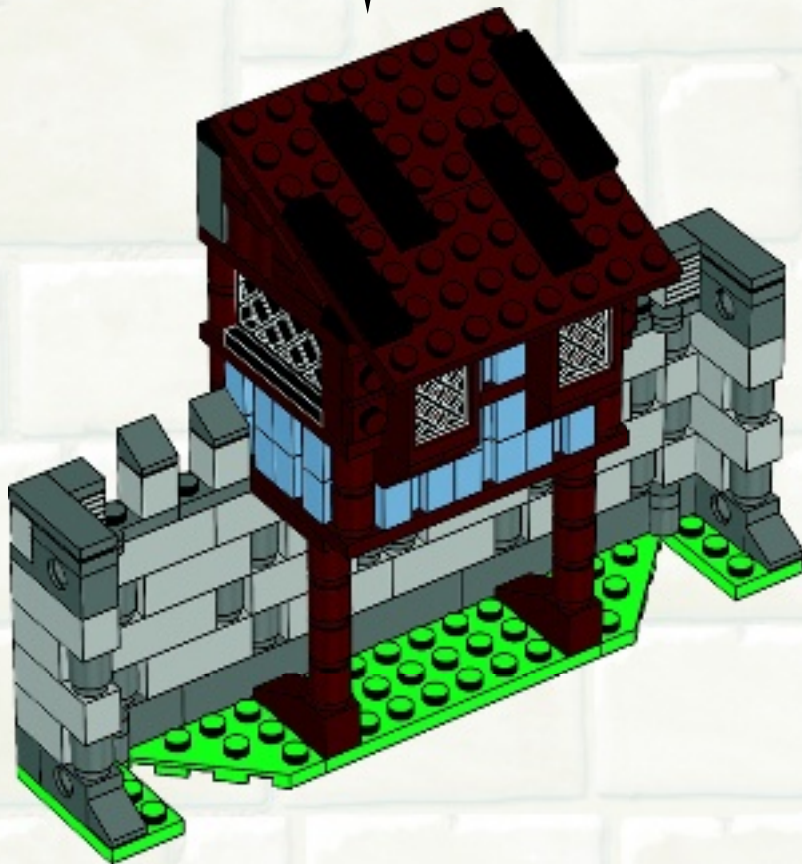

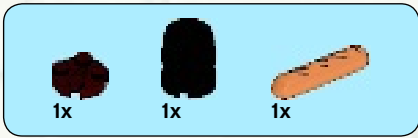

28

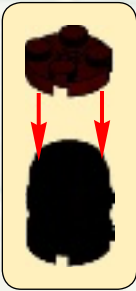



5

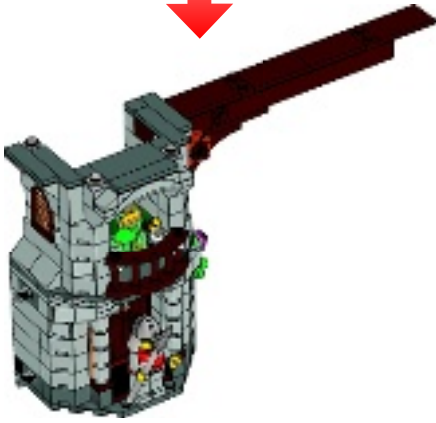

1x

1x

1

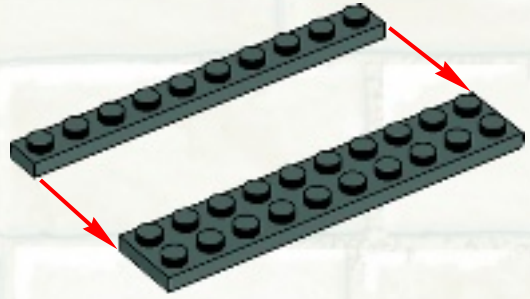

2x

2x

5x

2

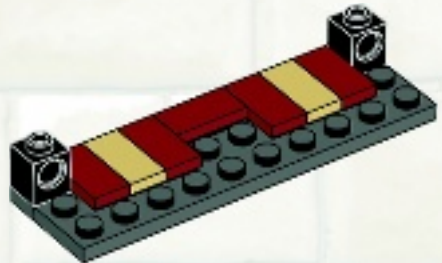

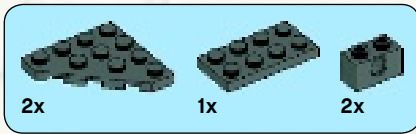

3

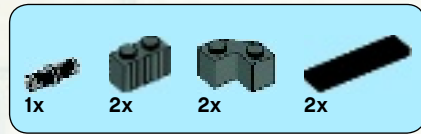
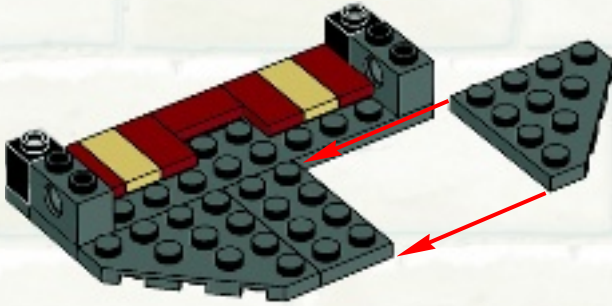

5

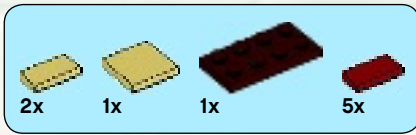
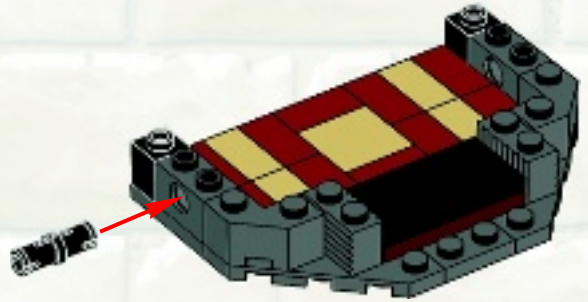

4

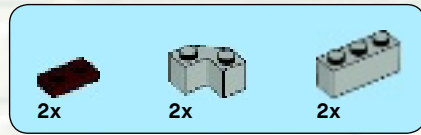
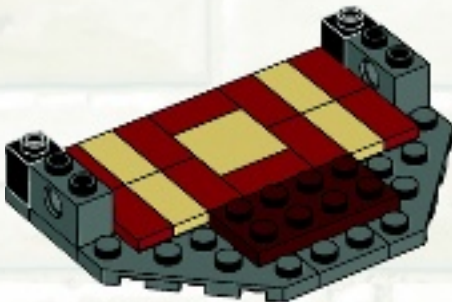

6

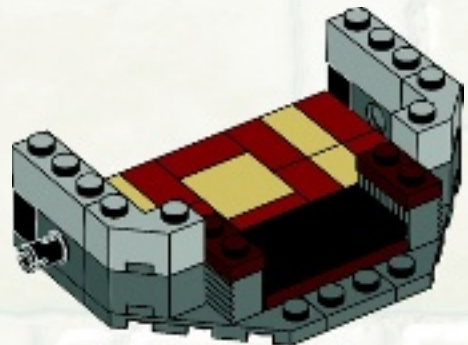

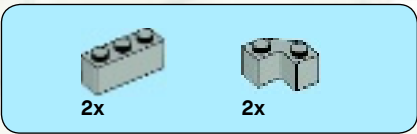

7

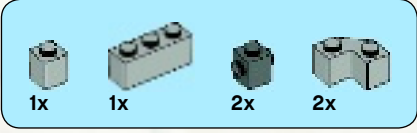
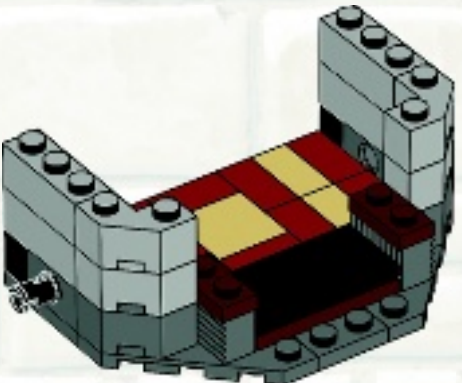

8

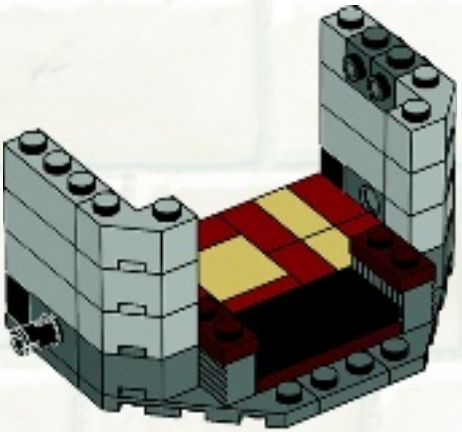

9

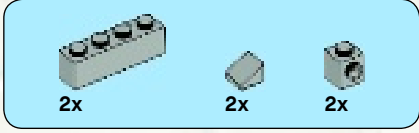
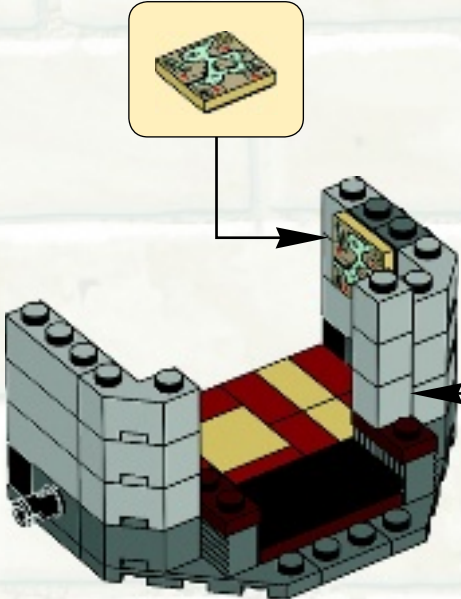

10

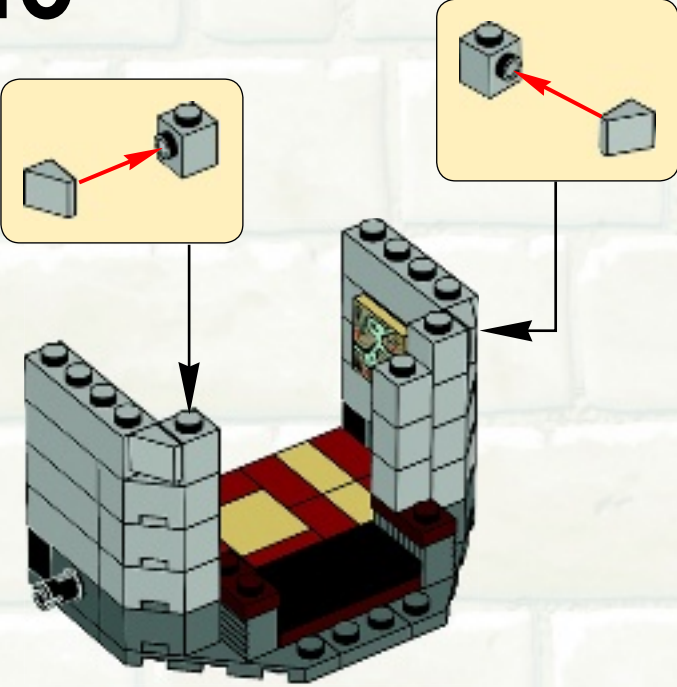



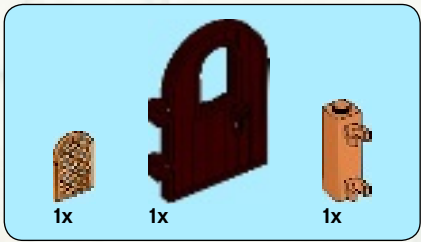

11

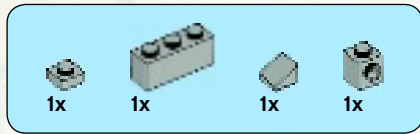
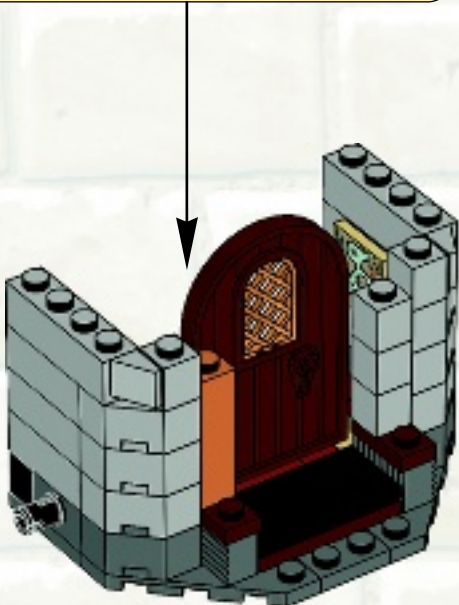
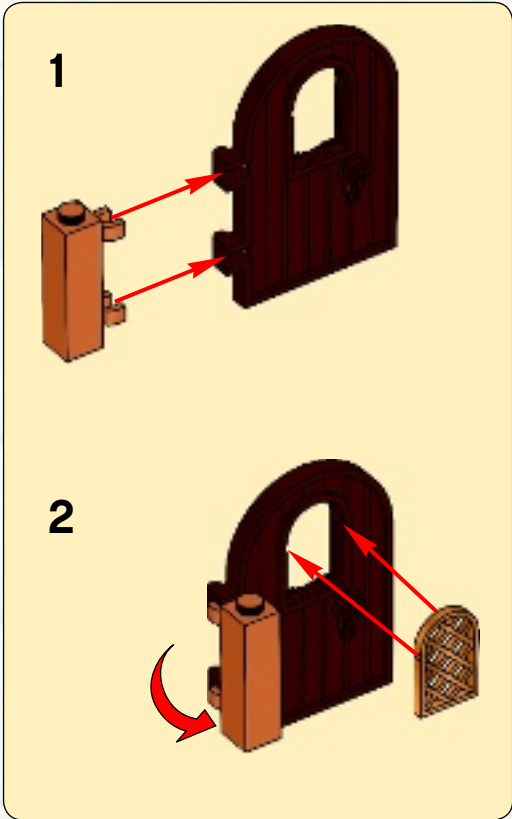

12

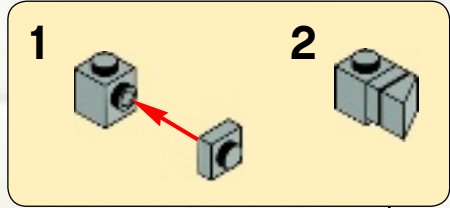

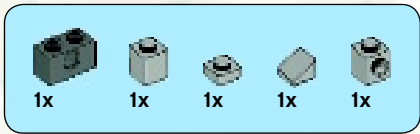

# 13

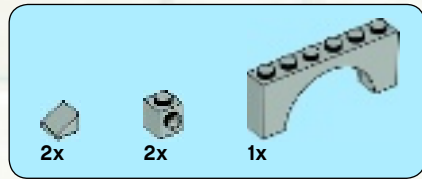
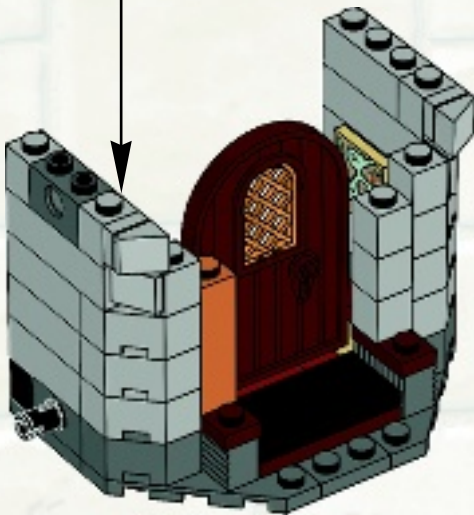
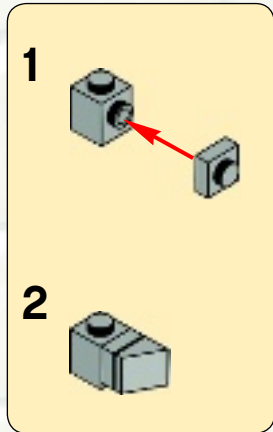

# 14

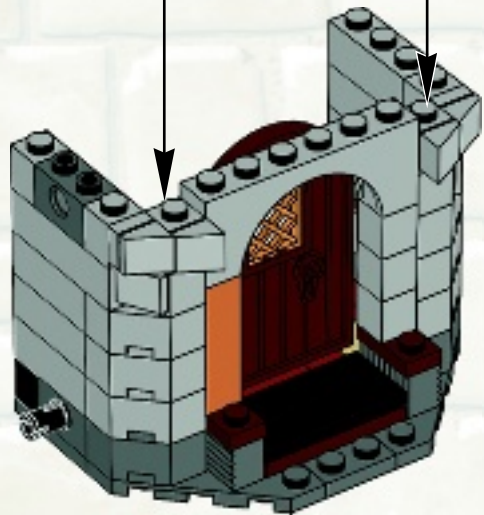
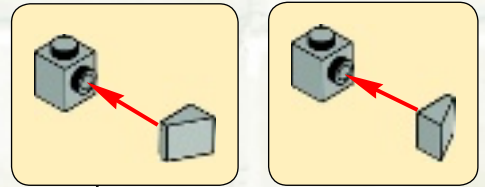



8x

# 15

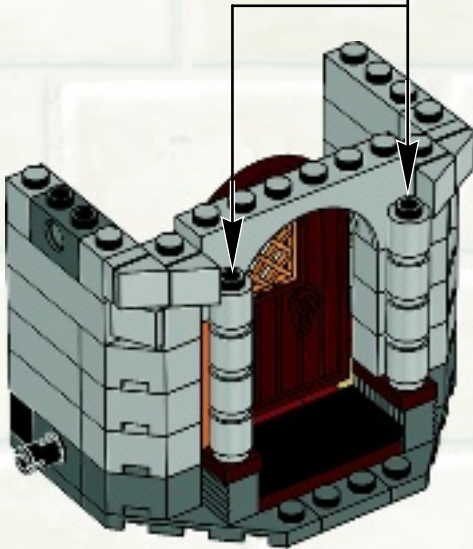
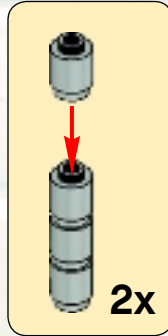

2x



2x

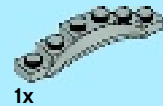

1x

# 16

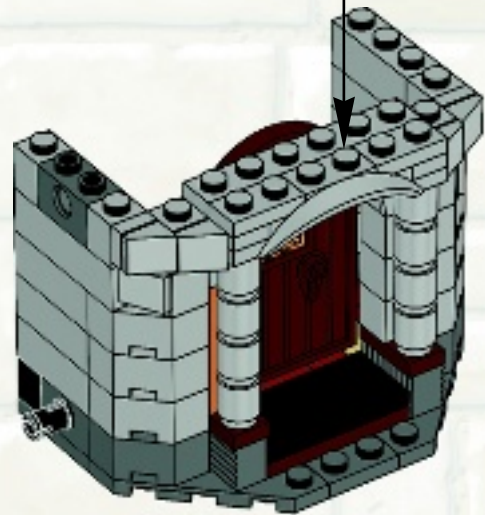
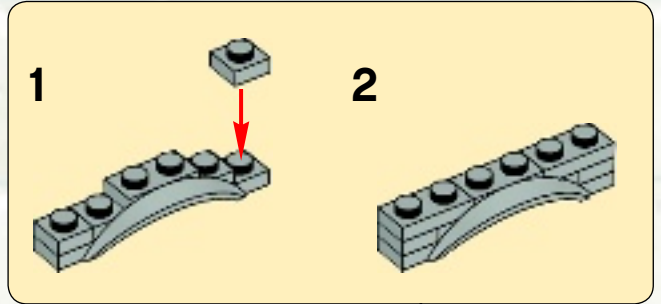



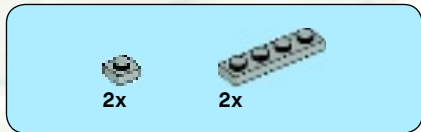

17

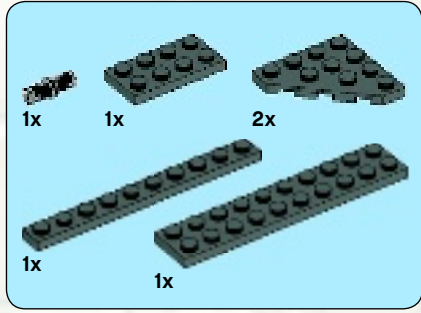
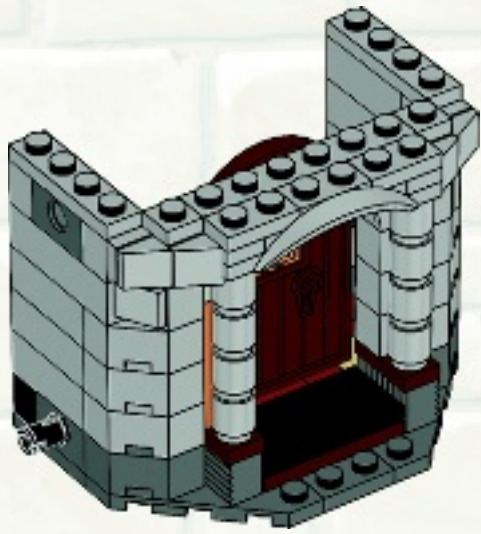

18

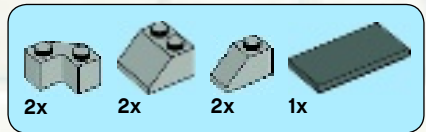
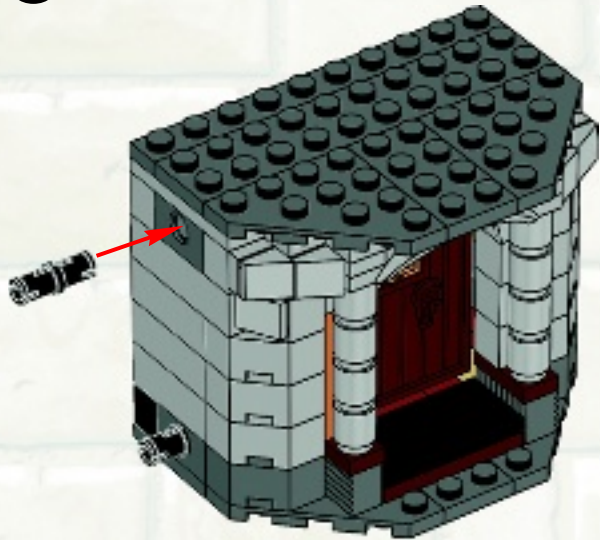

19

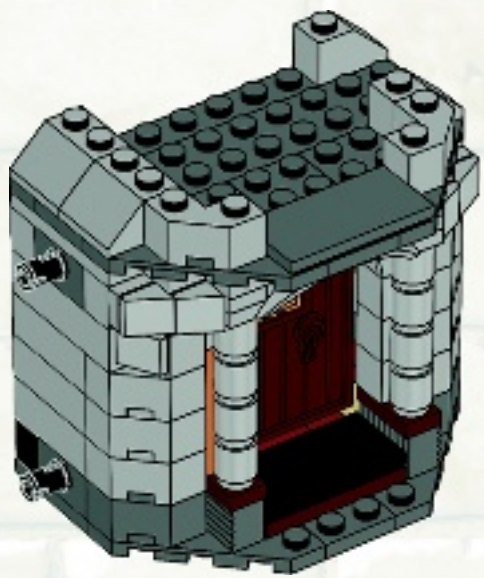

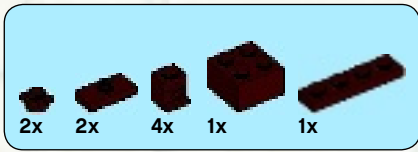

# 20

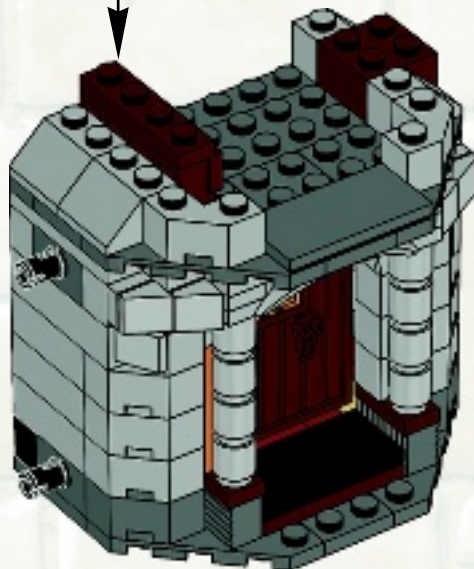
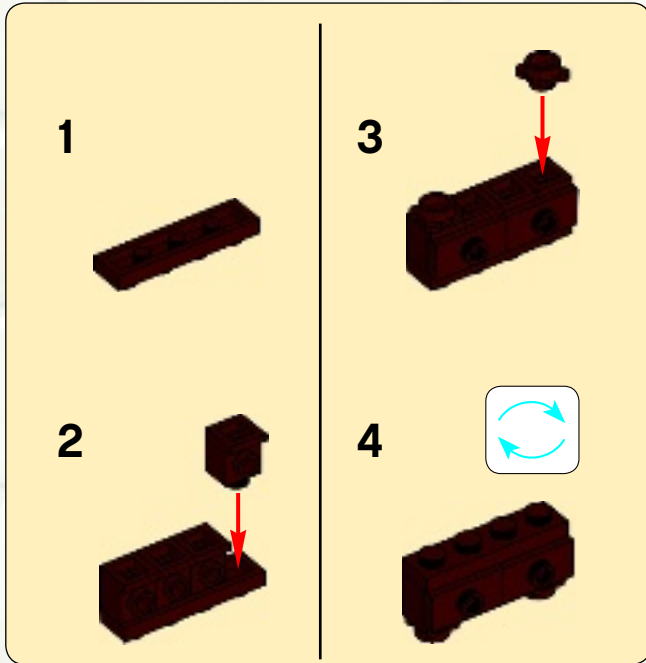

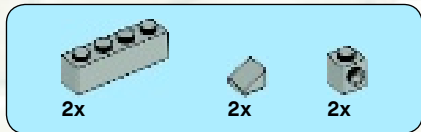

# 21

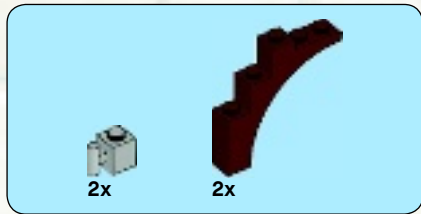
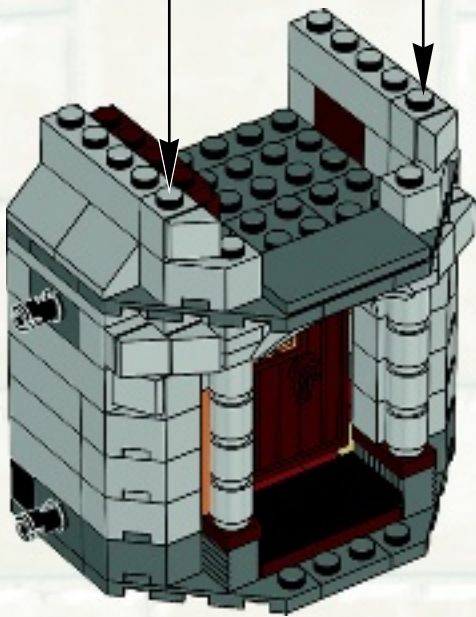
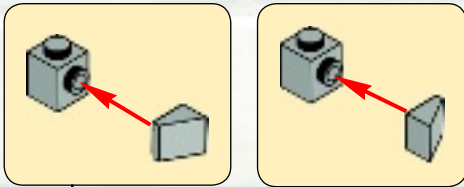

# 22





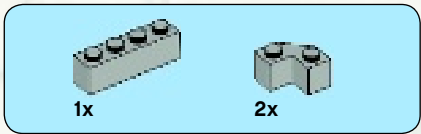

23

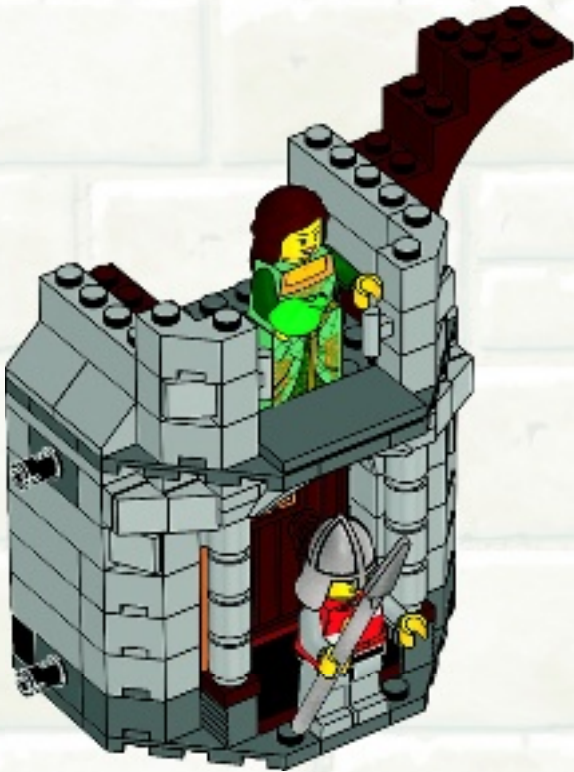

24

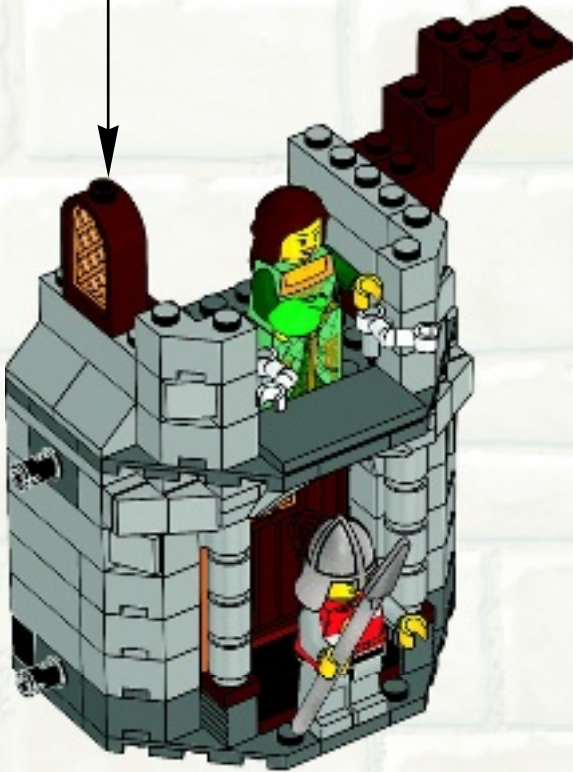

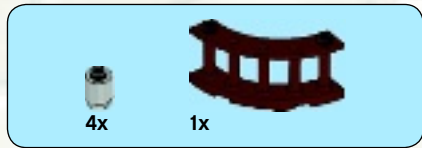

25

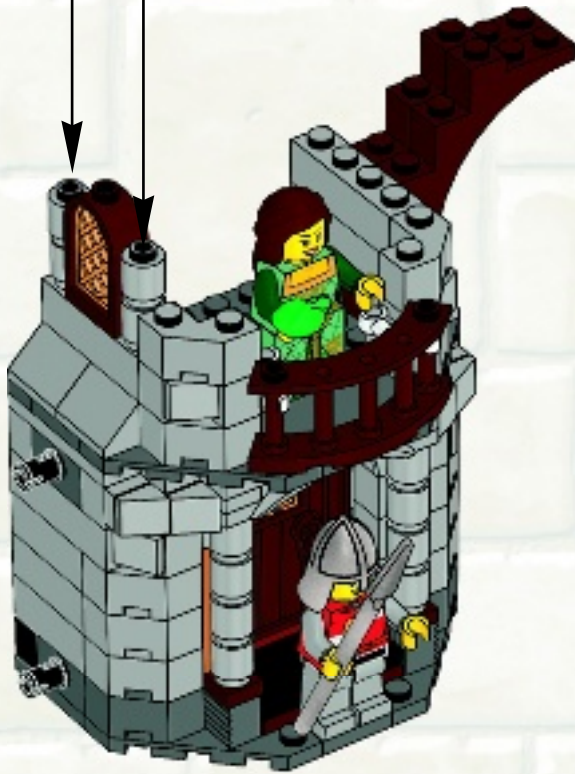
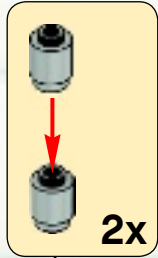

26

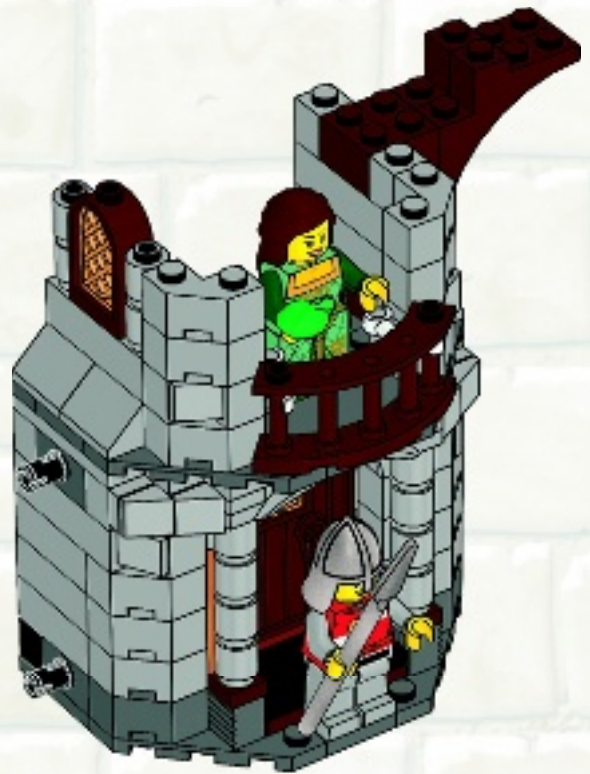

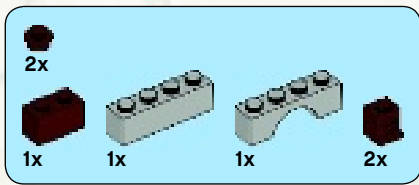

# 27

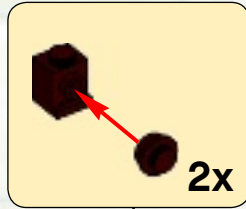

# 28

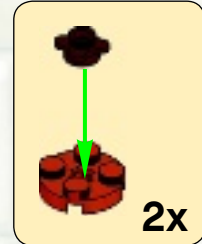



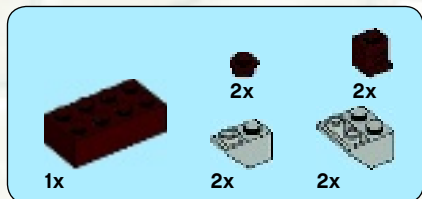

# 29

