



Kingdoms



7950



WARNING: CHOKING HAZARD.
Small parts. Not for children under 3 years.

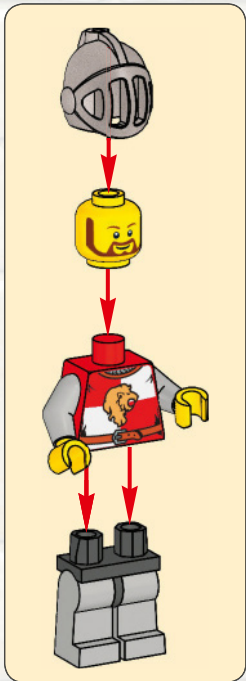

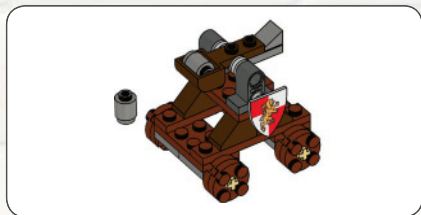

1

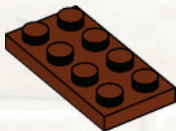

2

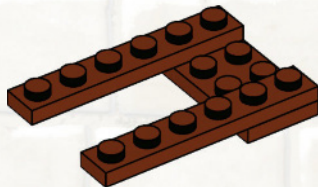

AVERTISSEMENT : RISQUE D'ÉTOUFFEMENT.

Contient des petites pièces. Ne convient pas aux enfants de moins de 3 ans.



ADVERTENCIA: PELIGRO DE ASFIXIA.

No recomendado para niños menores de 3 años. Contiene piezas pequeñas.

3

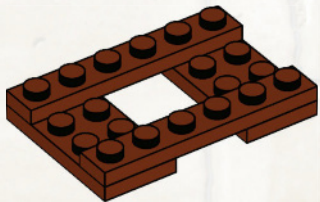

4

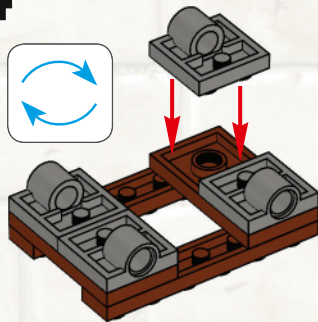

5

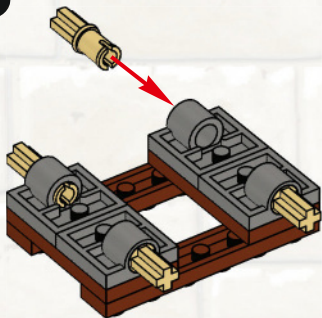

6

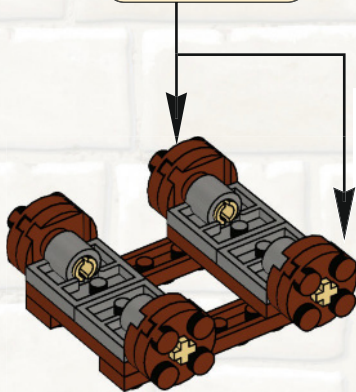
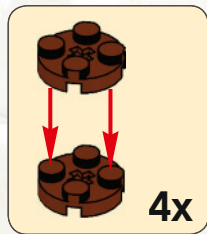

7

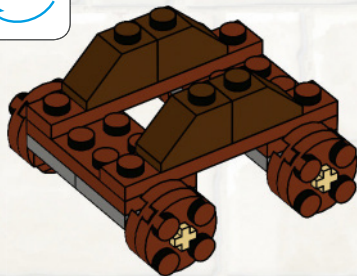

8

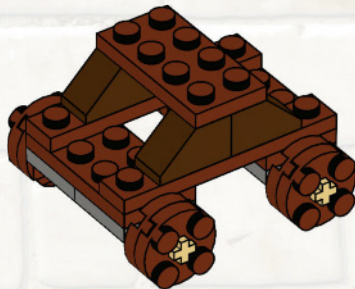

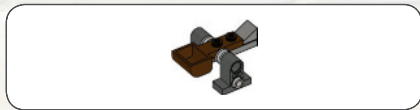

1



2

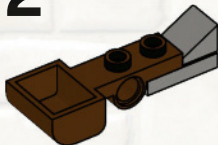

3

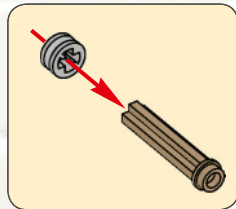
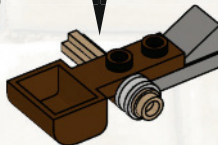

4

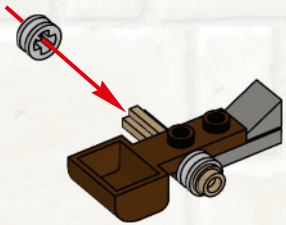

5

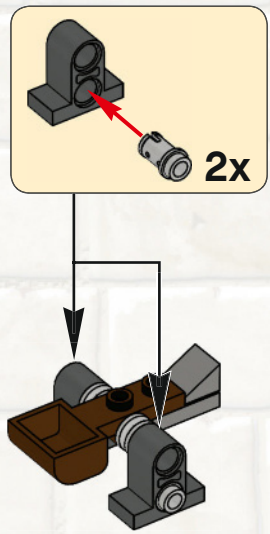

9

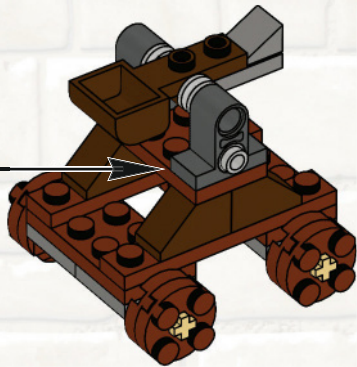

10

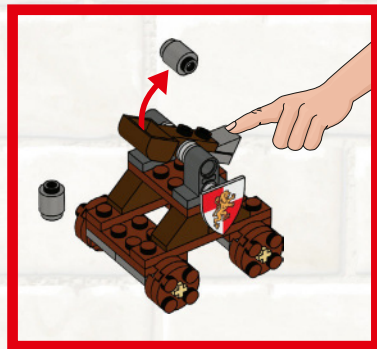
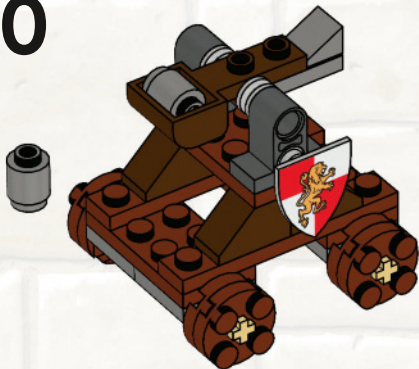



1



2



3

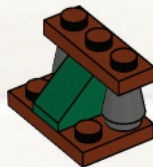

4

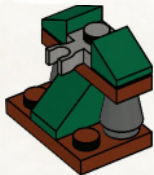

5

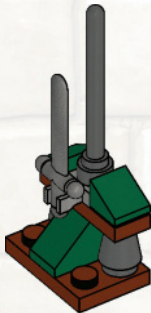

6

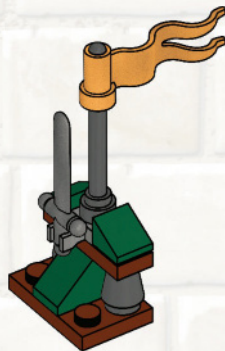



1x
4586497



1x
4584678



1x
4540552



1x
4528206



1x
4578503



2x
4529236



2x
4144024



1x
395726



1x
4586502



1x
4505002



1x
4566927



2x
4504375



1x
4255624



1x
4587127



1x
4224479



1x
4585482



1x
4211152



1x
4211189



3x
4211186



2x
4221590



8x
4211159



1x
4492335



1x
4586308



2x
4211573



2x
4211483



1x
4211063



2x
4211090



1x
4504378



1x
4587212



4x
4196768



1x
4504649



1x
4506721



4x
4518557



1x
4568951



1x
4586383



4x
4186017



Customer Service

Kundenservice

Service Consommateurs

Servicio Al Consumidor

www.lego.com/service or dial



: 00800 5346 5555

: 1-800-422-5346

7946



7947



7948



7949



7950



FREE! GRATIS! GRATUIT!



club
MAGAZINE™

www.LEGOclub.com



00800 5346 5555*        

  1-866-534-6258 • 1-877-518-5346

US & Canada only

Canada seulement

* Freephone. Mobile charges may apply. * Numéro sans Frais. Des Frais peuvent s'appliquer avec les téléphones cellulaires.

* Gebührenfrei, Kosten für Anrufe aus Mobilfunknetzen können abweichen. * Gratis telefonnummer vanaf vaste lijn.

* Det er ett gratis nummer, när du ringer fra Posttelefon. * Det är gratis, när du ringer från en Post telefon.



VISIT THE WORLD'S
BIGGEST LEGO® SHOP!

www.LEGOshop.com



WIN!

Go to www.nielsen.com/LEGO to fill out a survey for a chance to win a cool LEGO® Product.

No purchase necessary.

Open to all residents where not prohibited.



www.LEGO.com



www.nielsen.com/LEGO

GEWINNE!

Nimm an der Umfrage auf www.nielsen.com/LEGO teil und hab die Chance ein cooles LEGO® Produkt zu gewinnen!

Die Teilnahme am Gewinnspiel führt zu keinerlei Kaufverpflichtungen. Teilnahme in allen nicht ausgeschlossenen Ländern möglich.

WIN!

Ga naar www.nielsen.com/LEGO, vul een enquêteformulier in en maak kans op een cool LEGO® product.

Geen aankoopverplichting. Iedereen mag deelnemen, uitgezonderd ingezetenden van landen waar een enquêteverbod geldt.

GAGNE !

Visite www.nielsen.com/LEGO pour répondre à un questionnaire et avoir une chance de gagner un produit LEGO® très cool !

Aucune obligation d'achat. Ouvert à tous les résidents des pays autorisés.

当てよう!

www.nielsen.com/LEGO にアクセスして、アンケートにご記入ください。当選者にはレゴ製品を差し上げます。

お買い上げの必要はありません。禁止されていない限り、すべての皆様にご利用いただけます。

4626123

LEGO and the LEGO logo are trademarks of the LEGO Group. ©2010 The LEGO Group. ©2010 LucasFilm Ltd. & TM. All rights reserved. Used under authorization.