

The LEGO logo is positioned in the top left corner, featuring the word "LEGO" in white on a red square background.

HEROFACTORY

WARNING: CHOKING HAZARD.
Toy contains small parts and a small ball.
Not for children under 3 years.



DRILLDOZER

2192

HeroFactory.LEGO.com

A LEGO Technic robot assembly, model 2068, is shown in a dynamic pose. The robot is primarily orange and white, with a green circular element on its chest. It has a green antenna on its head and a blue and white component on its right arm. The robot is standing on a dark, textured surface. In the background, there are industrial structures, a red ball, and a flame. The number 2068 is displayed in white text above the robot.

2068



AVERTISSEMENT : RISQUE D'ÉTOUFFEMENT.

Le jouet contient des petites pièces ainsi qu'une petite boule. Il ne convient pas aux enfants de moins de 3 ans.



ADVERTENCIA: PELIGRO DE ASFIXIA.

Juguete que contiene partes pequeñas y una pelota pequeña. No recomendado para niños menores de 3 años.



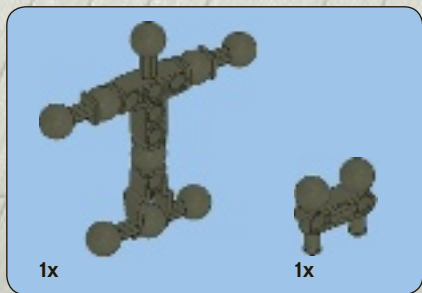

1

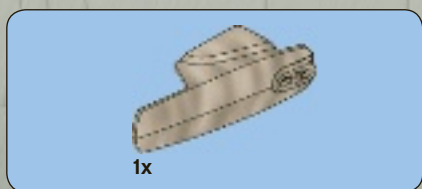
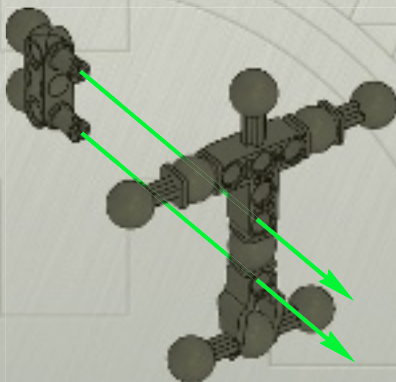

2

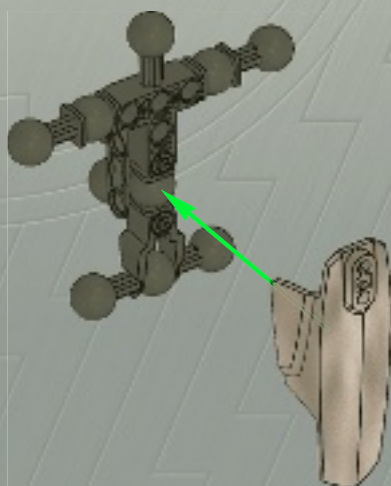

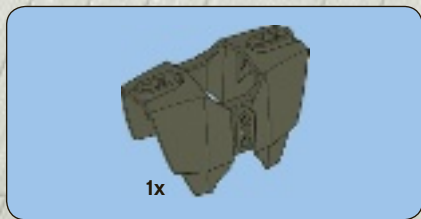

3

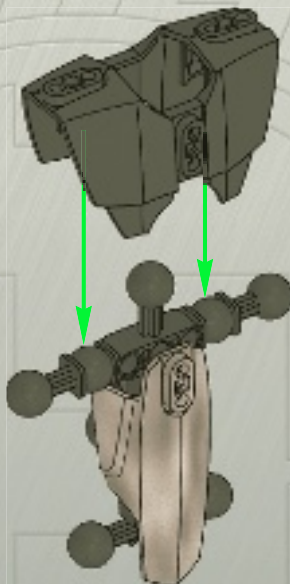

4

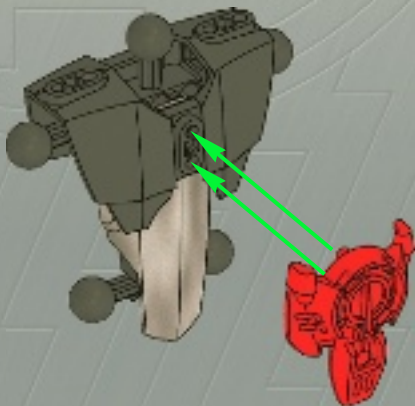

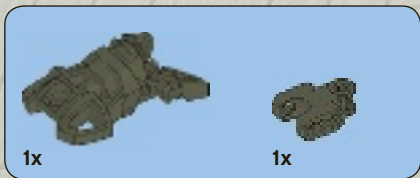

1

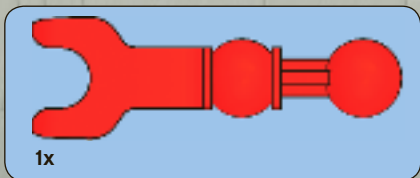
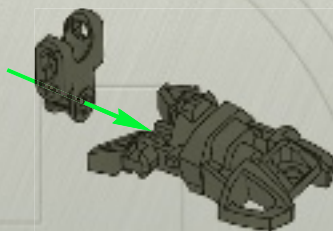

2

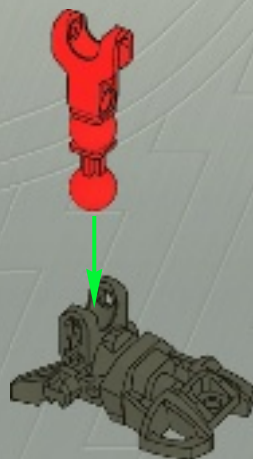



3

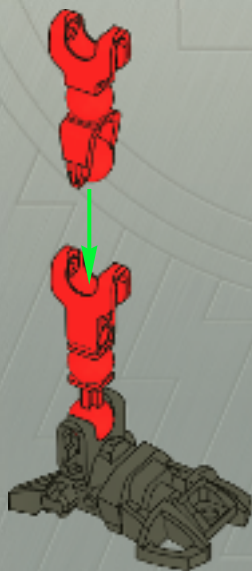

2x

5

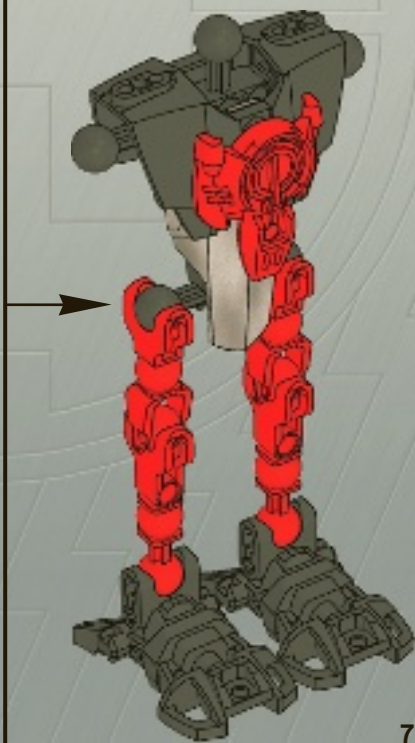



6

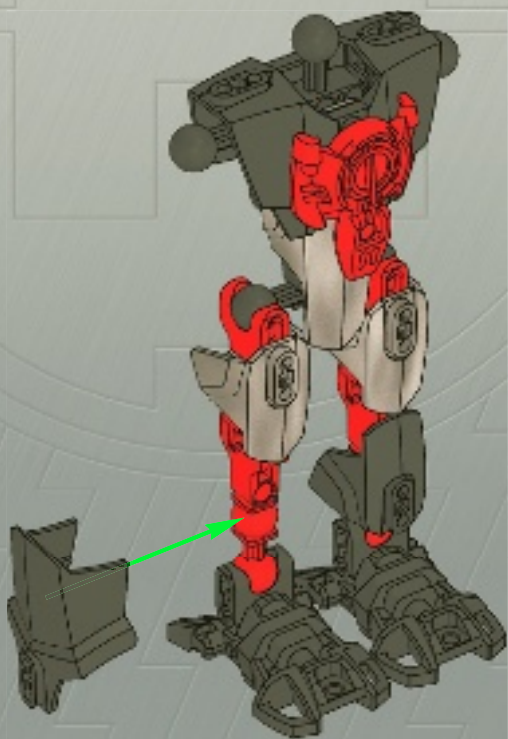

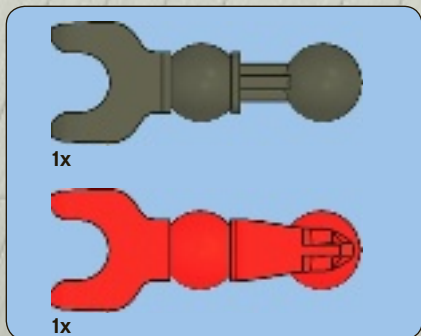

1

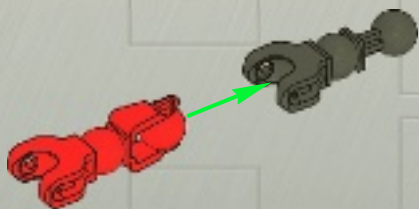

2

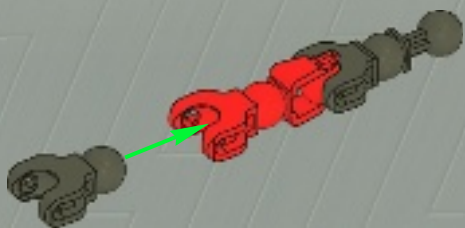



3

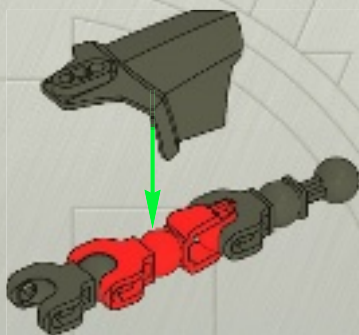

4

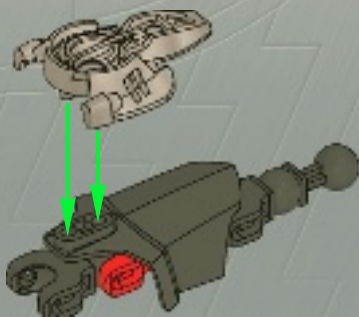



5

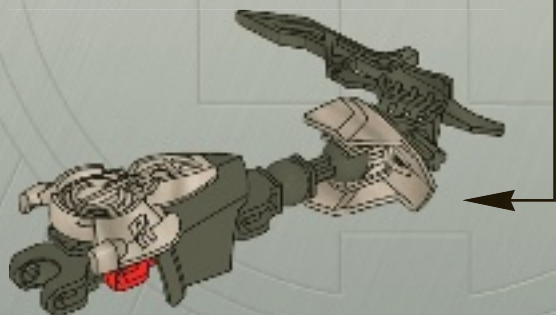
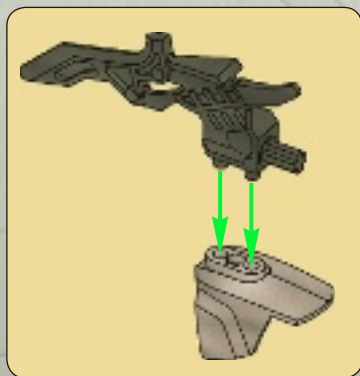

7

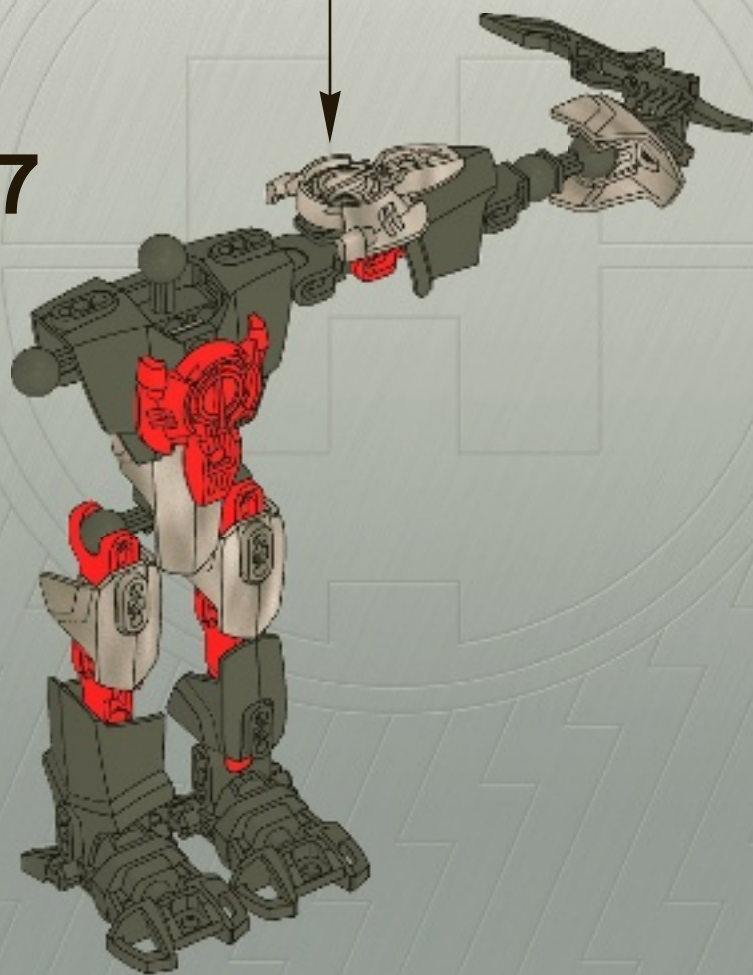



1



2

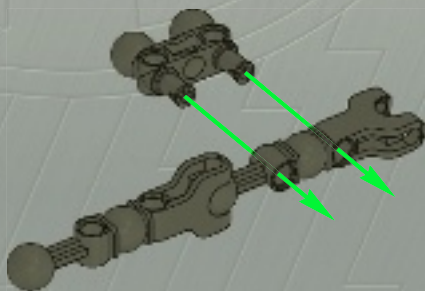



3

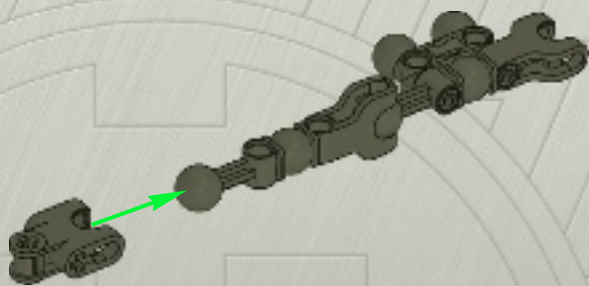

4

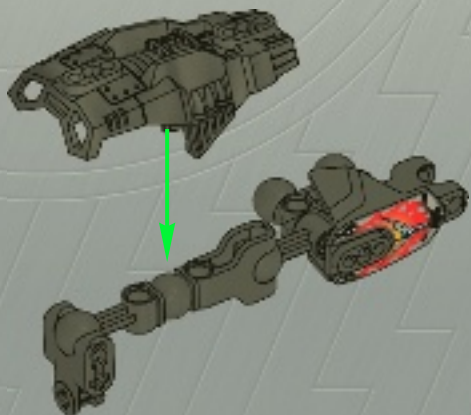



5

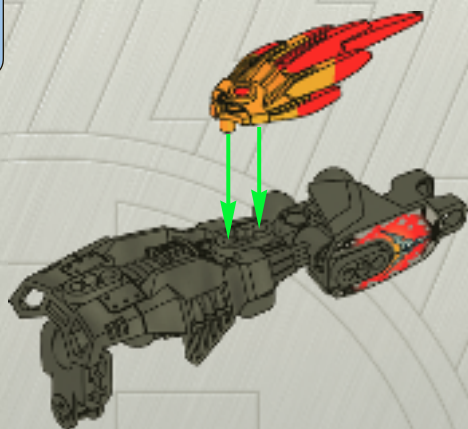

8

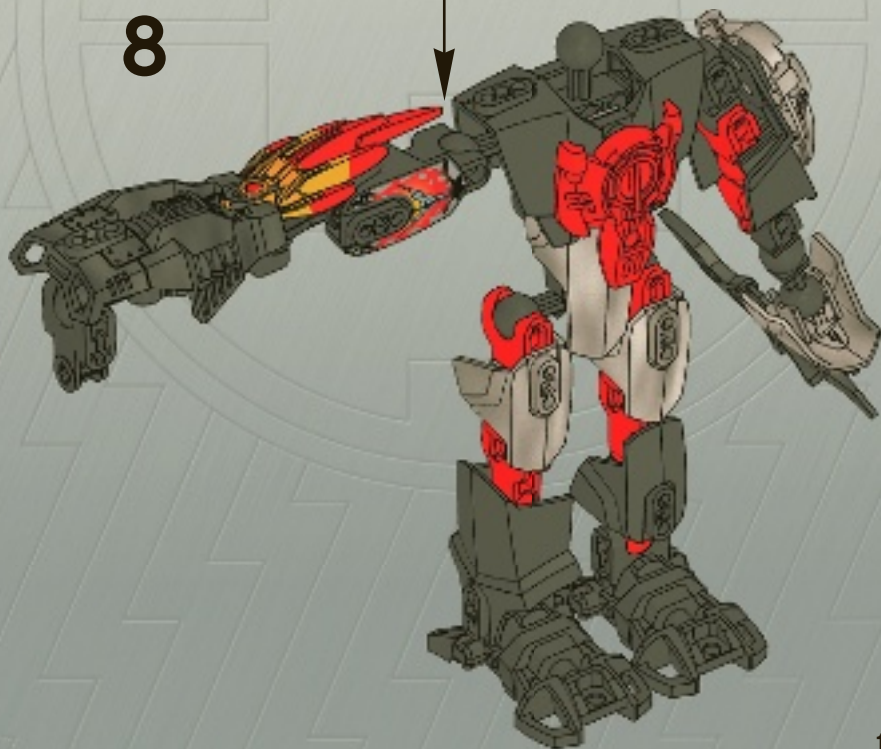



9

1



2



3



4



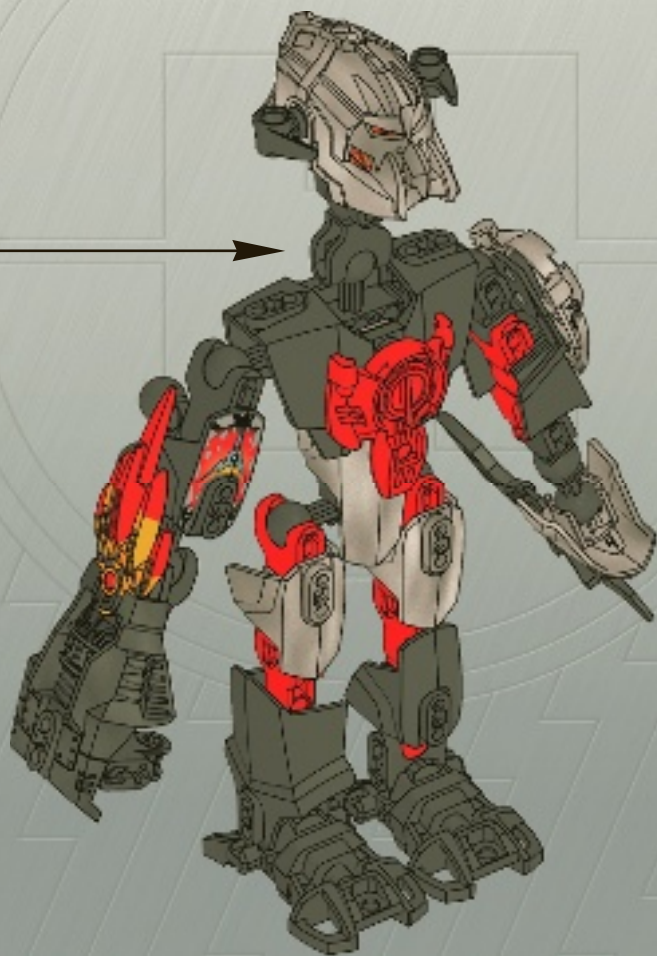

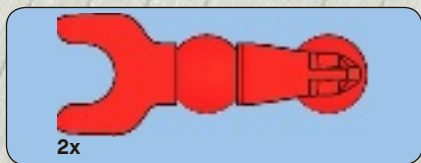

1

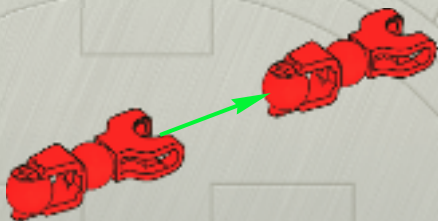

2

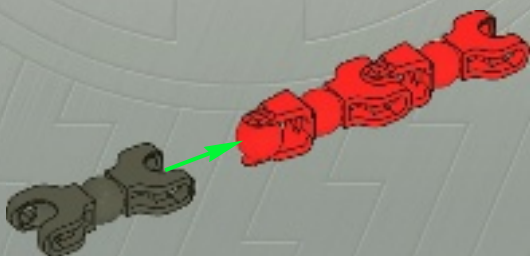



10

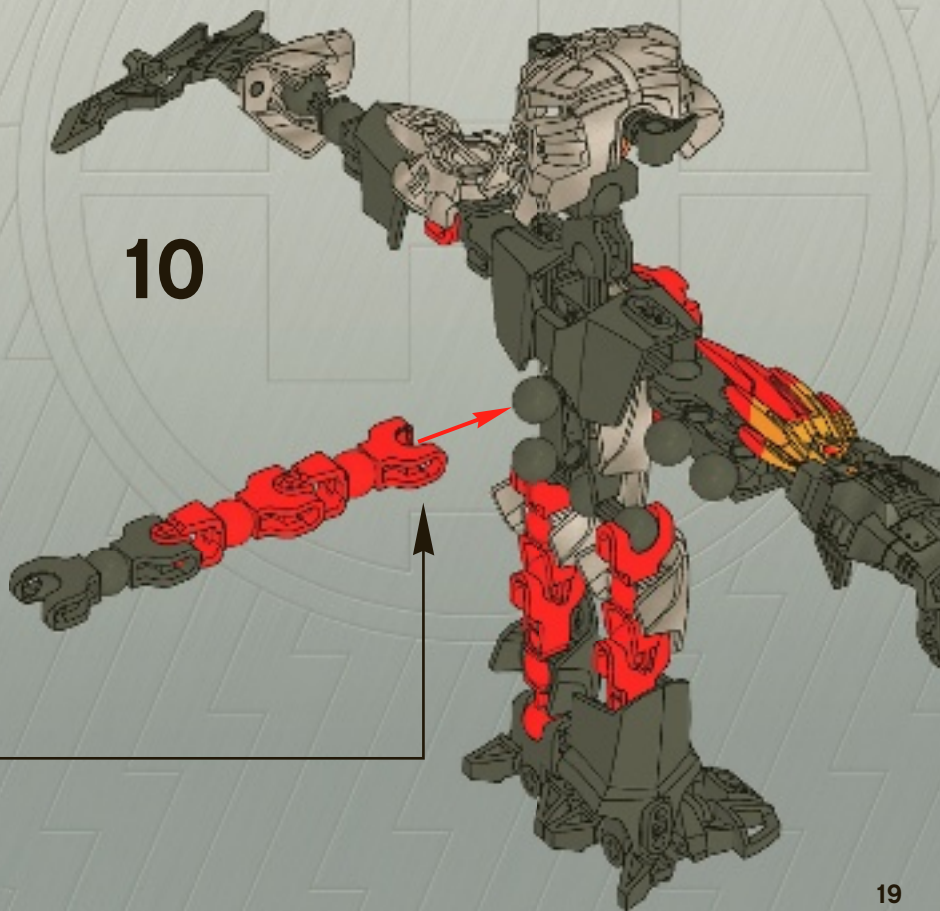



1

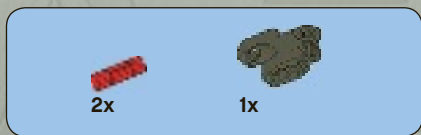
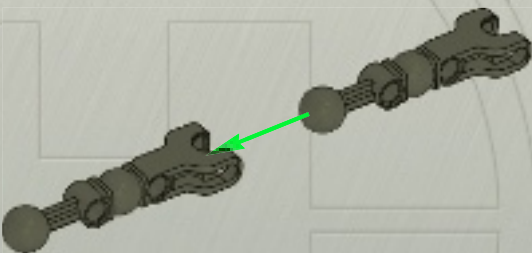

2

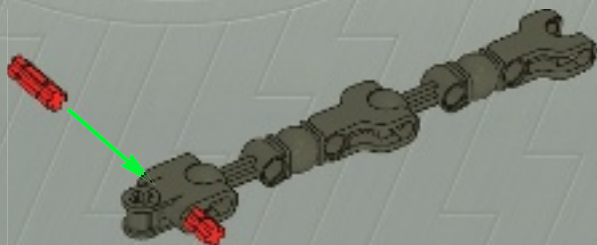

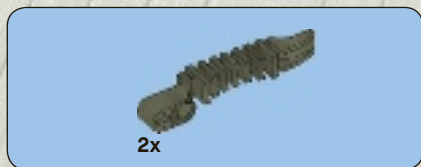

3

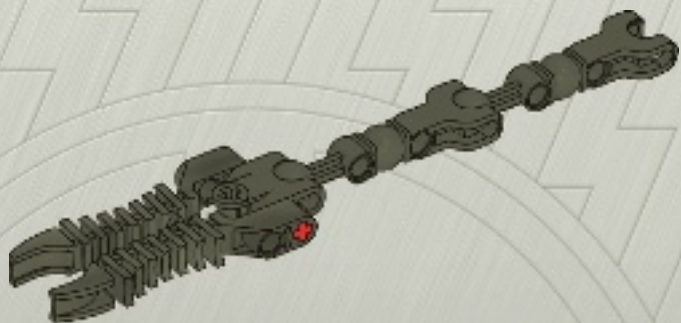

11

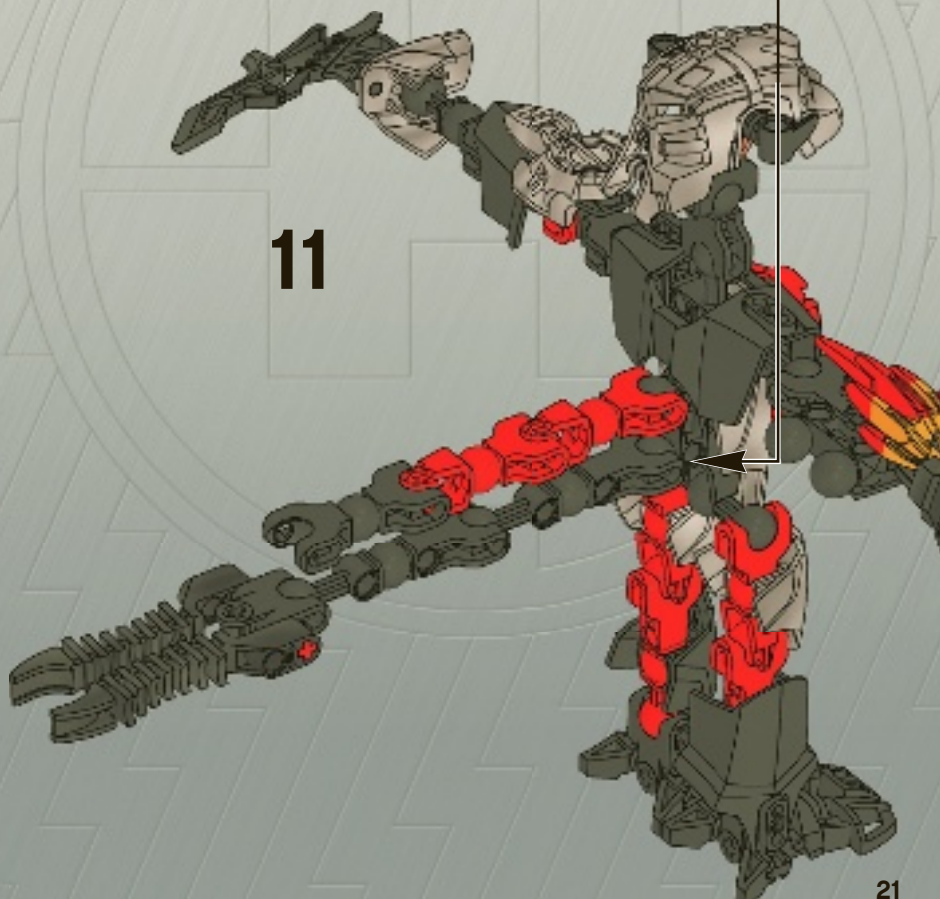



12

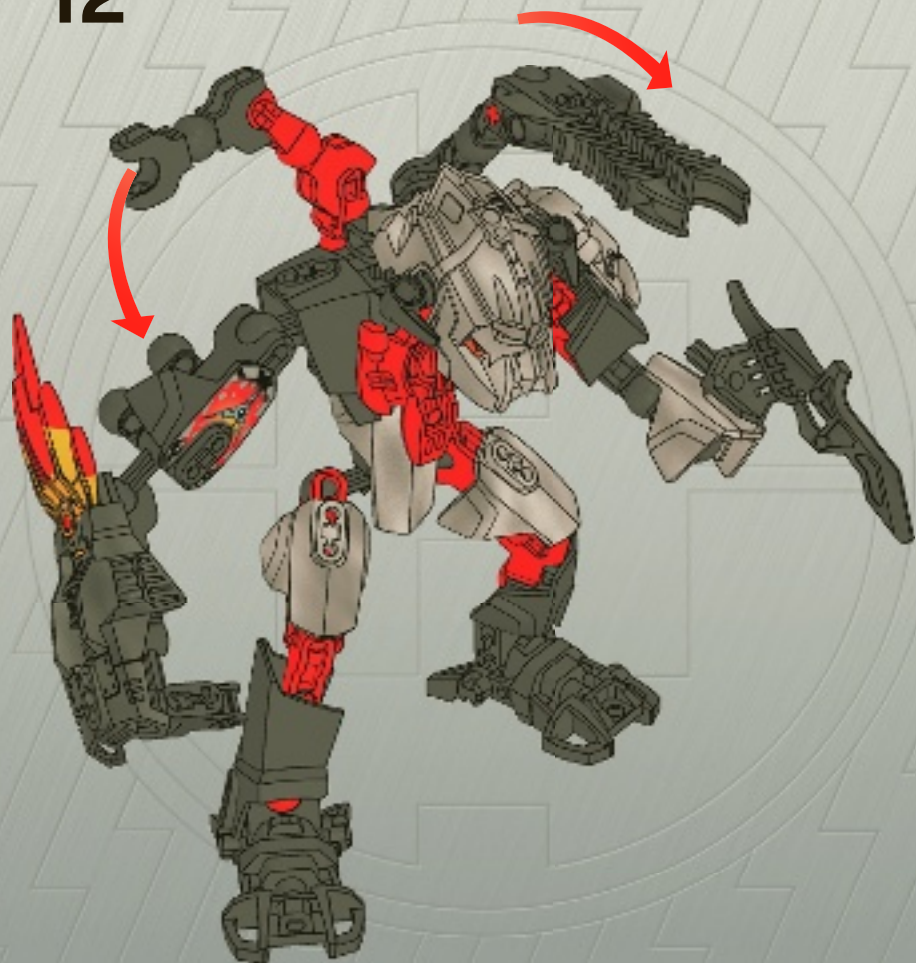



13

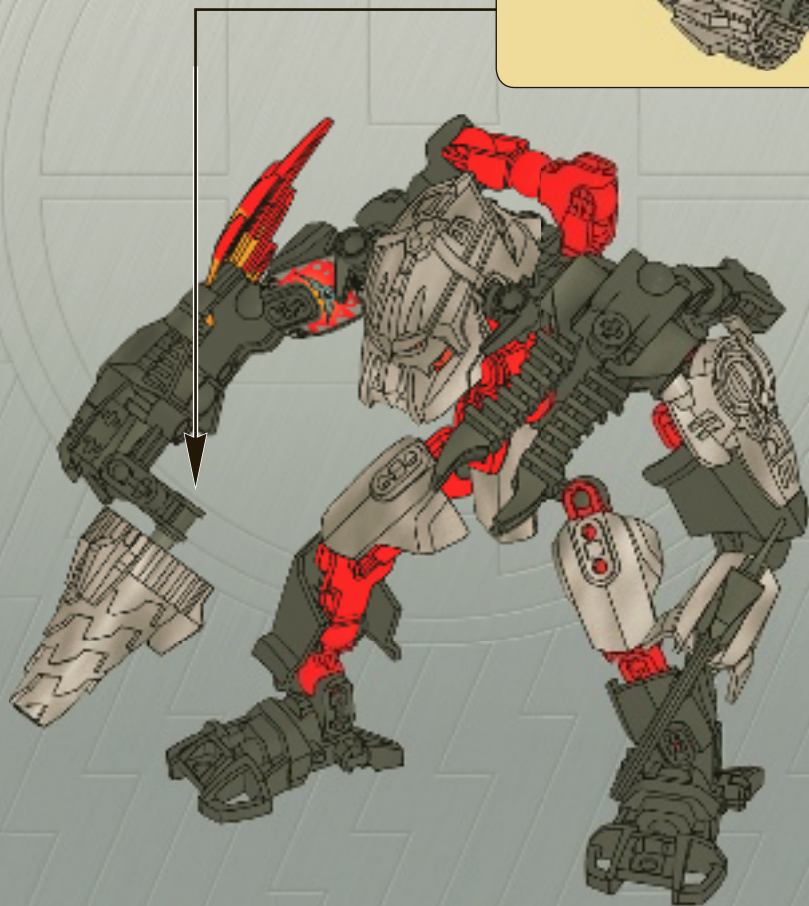
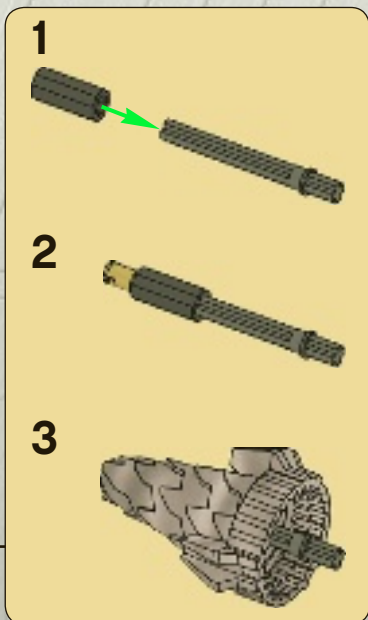



8x

14

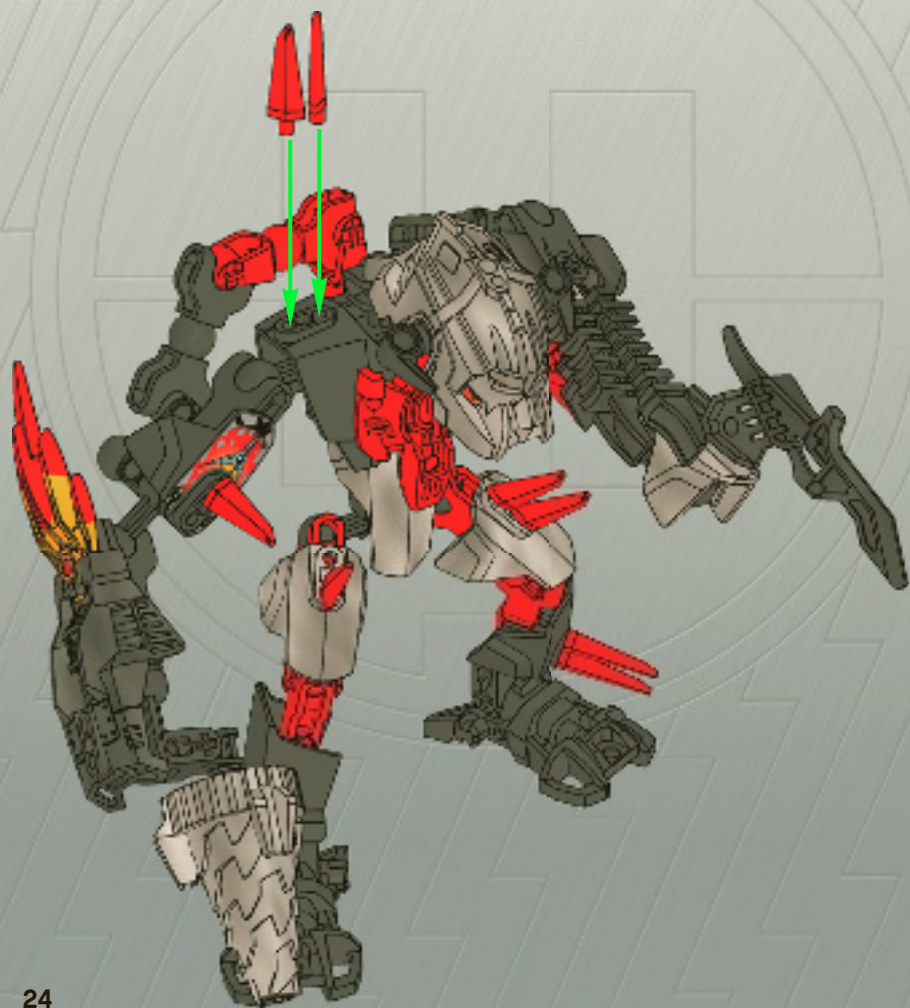

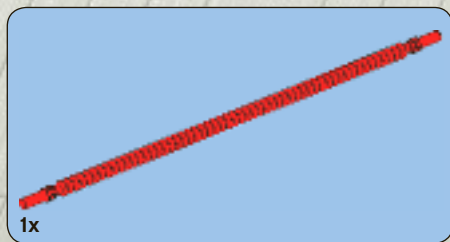

15

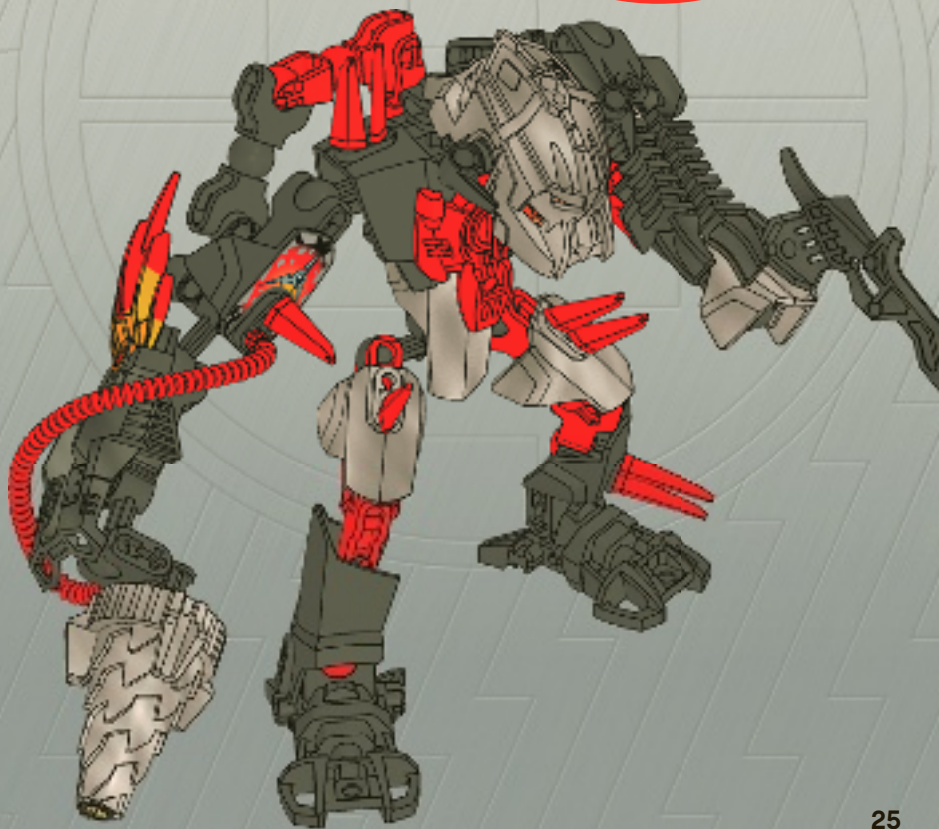
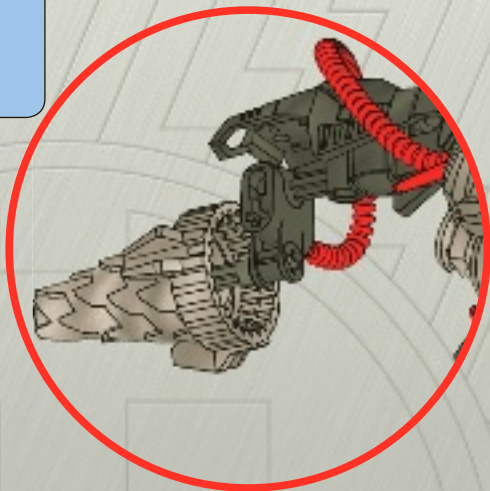



1x

16

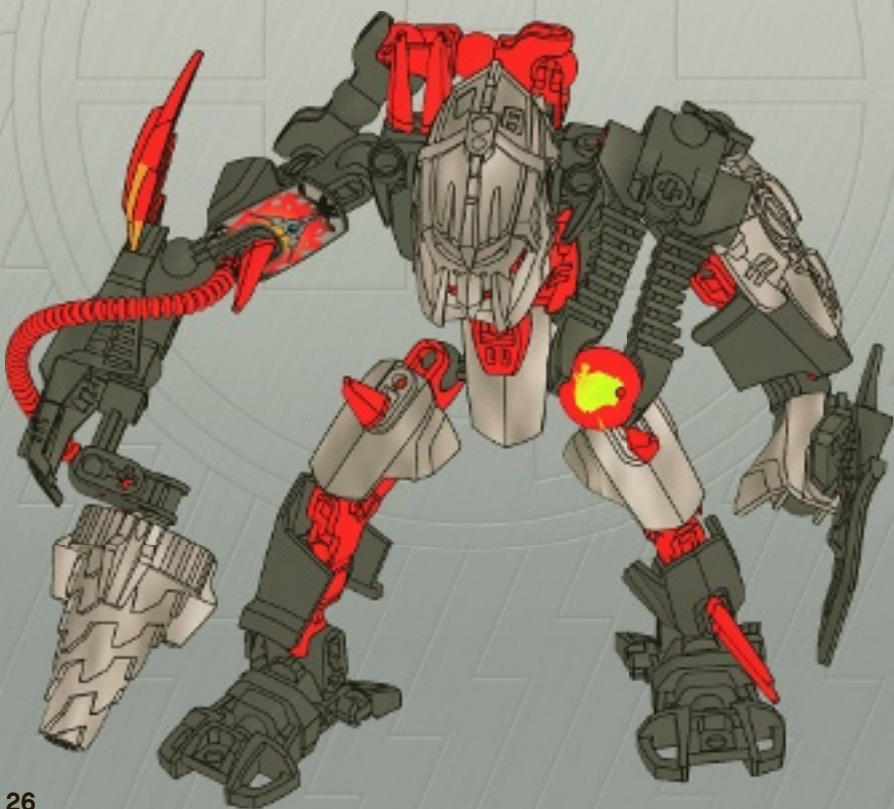
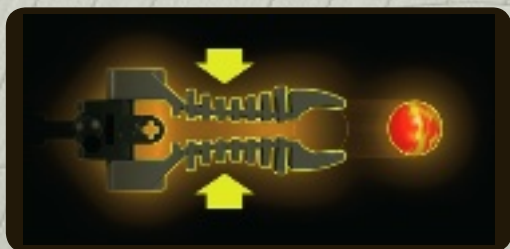

1x
4512363

1x
4540702

1x
4508553

1x
4186017

8x
4616842

5x
4603782

2x
4611614

1x
4622390

1x
4591604

1x
4591614

2x
4142865

1x
4609780

1x
4612489

2x
4609686

1x
4609731

1x
4591610

1x
4614349

3x
4632619

1x
4632598

1x
4609774

2x
4593576

4x
4610948

3x
4593557

1x
4593567

1x
4593555

4x
4593553

2x
4612590

1x
4632618

1x
4632622

2x
4609820

2x
4565616

1x
4610708

1x
4593571

Customer Service

Kundenservice

Service Consommateurs

Servicio Al Consumidor

www.lego.com/service or dial

							
				: 00800 5346 5555			
		: 1-800-422-5346					





LEGO

HERO FACTORY



NATALIE BREEZ
NATHAN EVO
PRESTON STORMER

JULIUS NEX
WILLIAM FURNO
MARK SURGE

HeroFactory.LEGO.com





HERO RECON TEAM

 DESIGN by ME



HeroFactory.LEGO.com

Coming spring 2011

DE: Ab Frühling 2011, FR/FRCA: Sortie au printemps 2011,

ES/ESSA: Disponible en primavera de 2011,

PT: Próxima primavera 2011, HU: 2011 tavaszán érkezik.



www.LEGOclub.com

LEGO club™

FREE! GRATIS! GRATUIT!



LEGO® Club Magazine



LEGO® Club Email

SIGN UP ONLINE!
www.LEGOclub.com

VISIT THE WORLD'S
BIGGEST LEGO® SHOP!
www.LEGOshop.com

00800 5346 5555

 1-866-534-6258 • 1-877-518-5346

USA & Canada only

EUROPE



* Freephone. Mobile charges may apply. * Numéro sans frais. Des frais peuvent s'appliquer avec les téléphones cellulaires. * Gebührenfrei, Kosten für Anrufe aus Mobilfunknetzen können abweichen. * Gratis telefoonnummer vanaf vaste lijn. * Det er et gratis nummer, når du ringer fra fasttelefon. * Det är gratis, när du ringer från en fast telefon. * Numéro sans frais. Des frais peuvent s'appliquer avec les téléphones portables.

B1112



WIN!

Go to www.LEGOsurvey.com/product to fill out a survey for a chance to win a cool LEGO® Product.

No purchase necessary.

Open to all residents where not prohibited.



www.LEGO.com



www.LEGOsurvey.com/product

GEWINNE!

Nimm an der Umfrage auf www.LEGOsurvey.com/product teil und hab die Chance ein cooles LEGO® Produkt zu gewinnen!

Die Teilnahme am Gewinnspiel führt zu keinerlei Kaufverpflichtungen. Teilnahme in allen nicht ausgeschlossenen Ländern möglich.

4620949

WIN!

Ga naar www.LEGOsurvey.com/product, vul een enquêteformulier in en maak kans op een cool LEGO® product.

Geen aankoopverplichting. Iedereen mag deelnemen, uitgezonderd ingezetenden van landen waar een enquêteverbod geldt.

GAGNE!

Visite www.LEGOsurvey.com/product pour répondre à un questionnaire et avoir une chance de gagner un produit LEGO® très cool!

Aucune obligation d'achat. Ouvert à tous les résidents des pays autorisés.

当てよう!

www.LEGOsurvey.com/product にアクセスして、アンケートにご記入ください。当選者にはレゴ®製品を差し上げます。

お買い上げの必要はありません。禁止されていない限り、すべての皆様にご利用いただけます。