

LEGO

PRINCE OF
PERSIA
THE SANDS OF TIME



7569



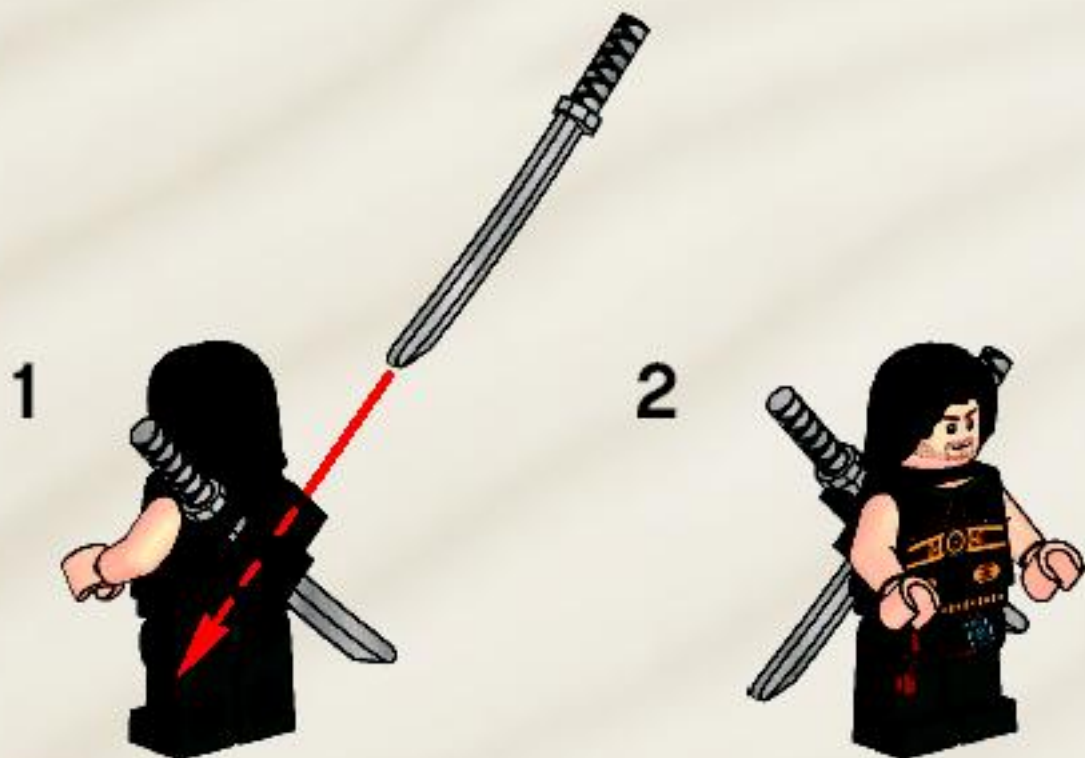
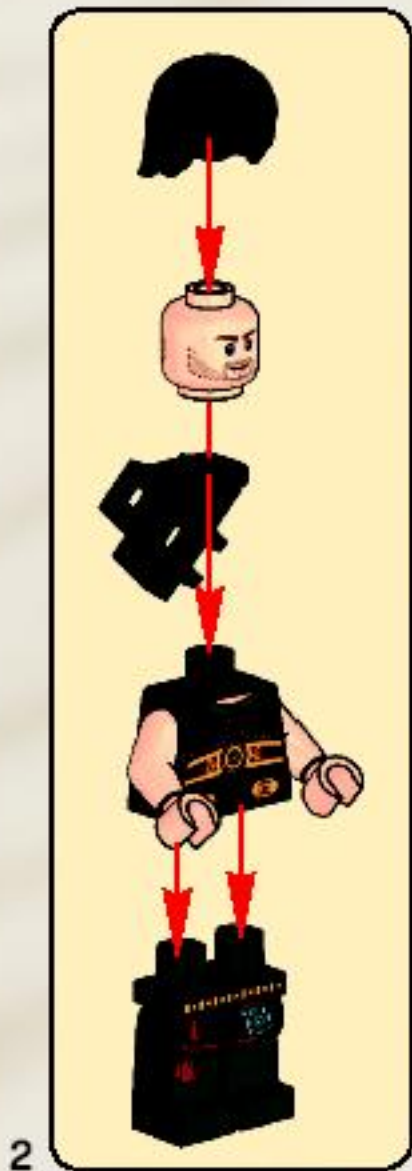

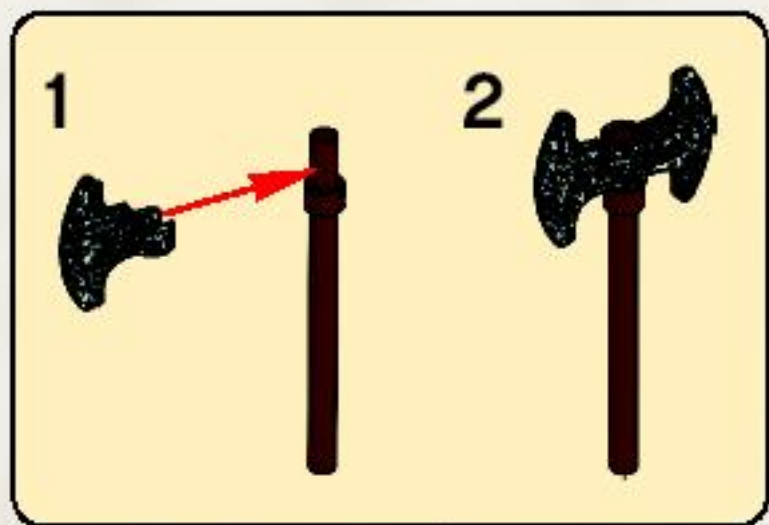
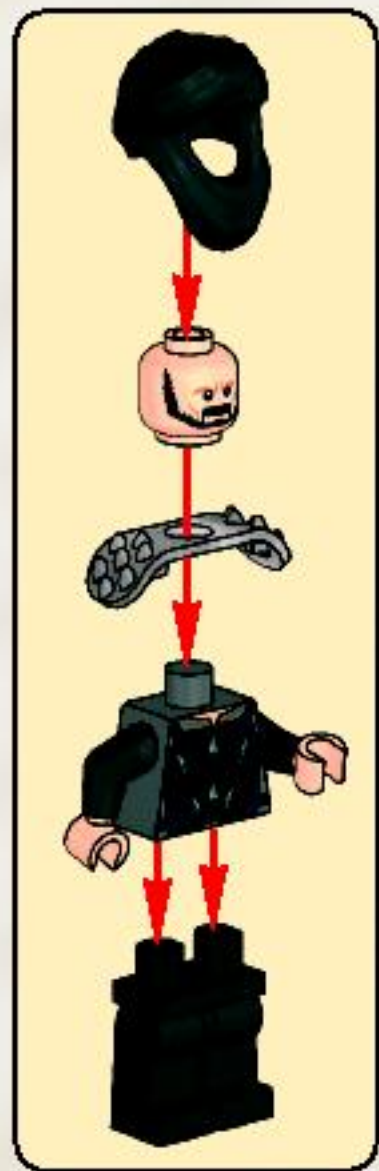

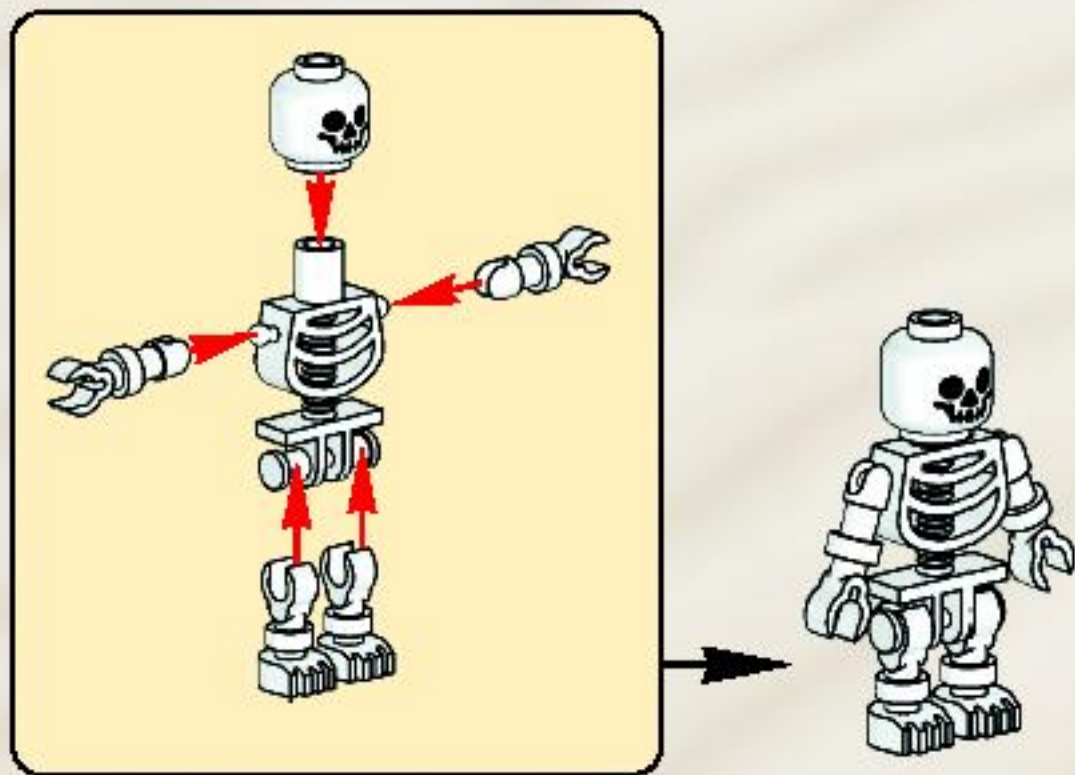

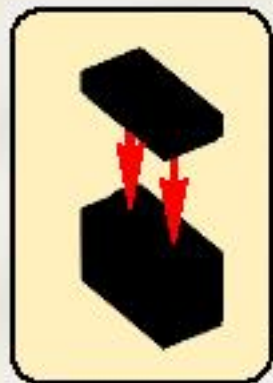

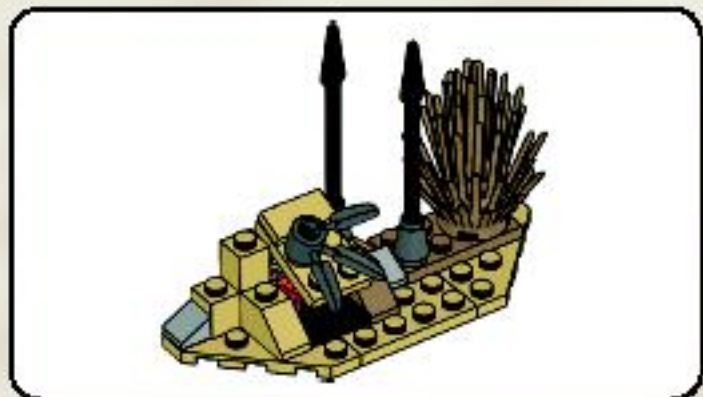

1

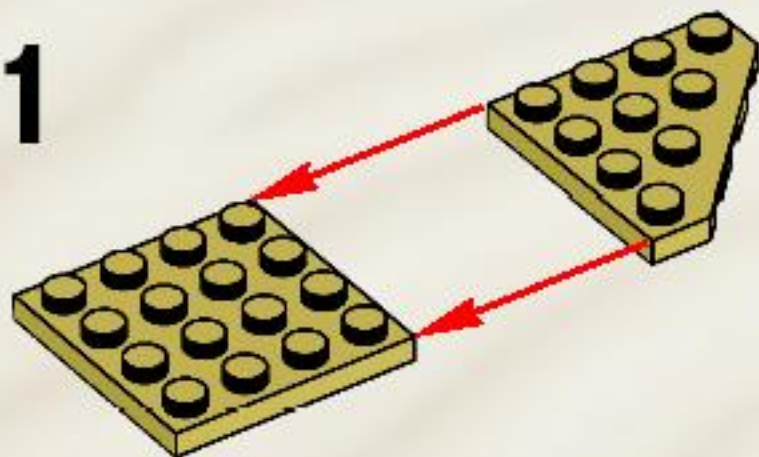

2

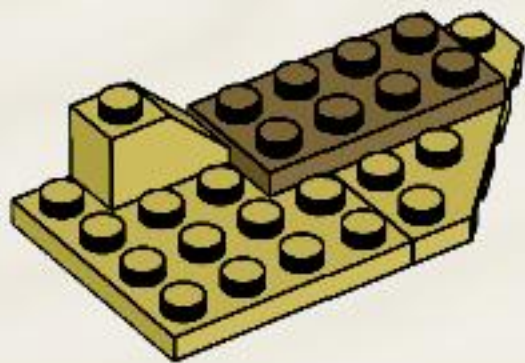

3

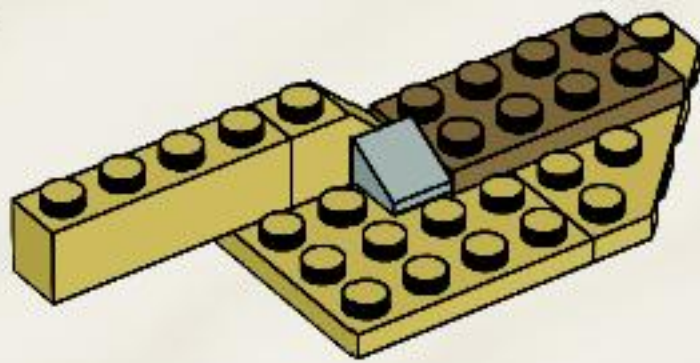

4

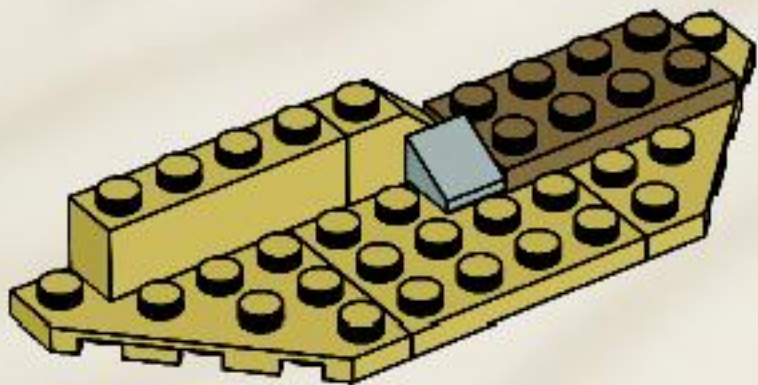

5

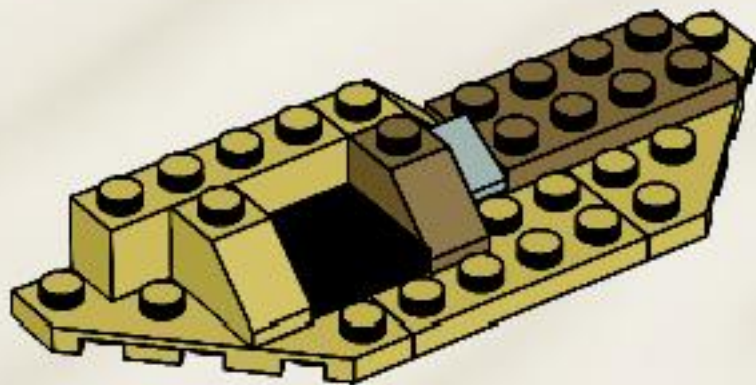

6

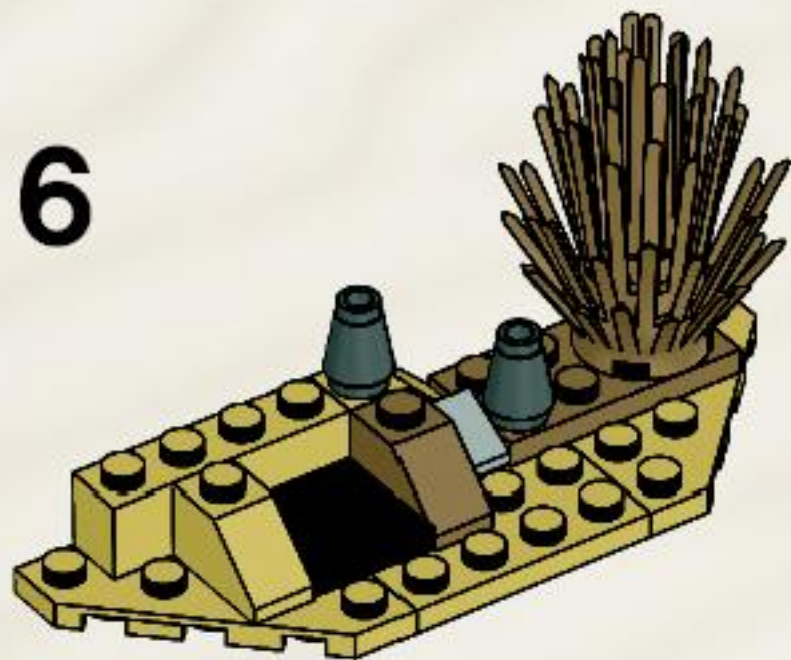

7

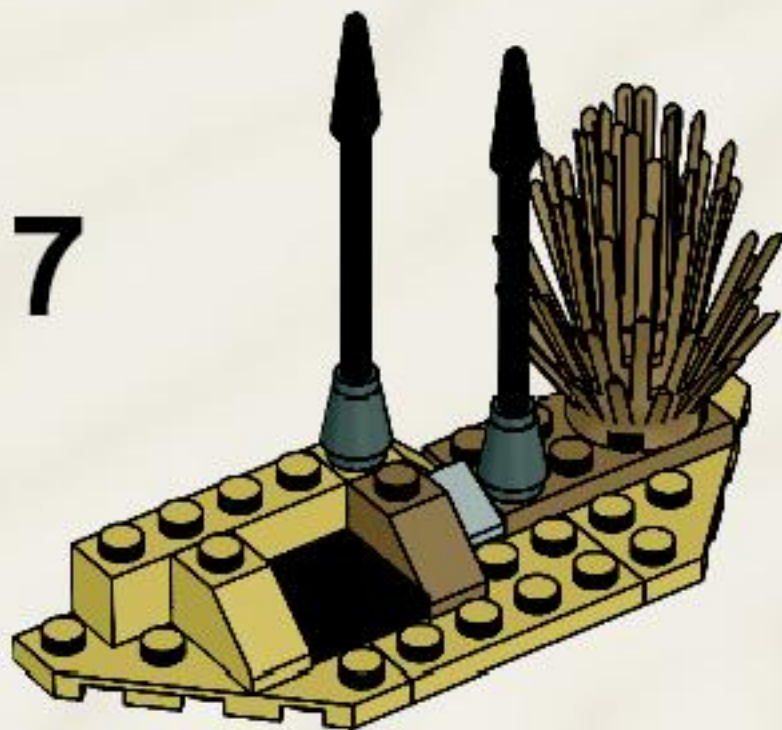

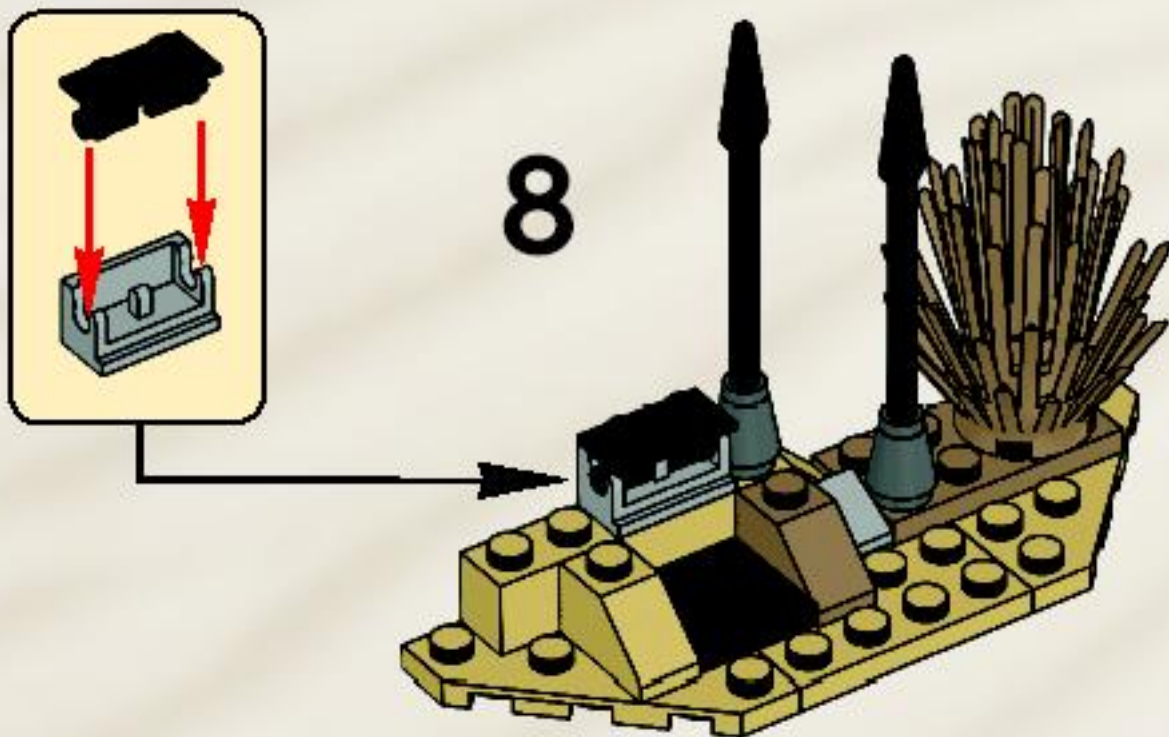

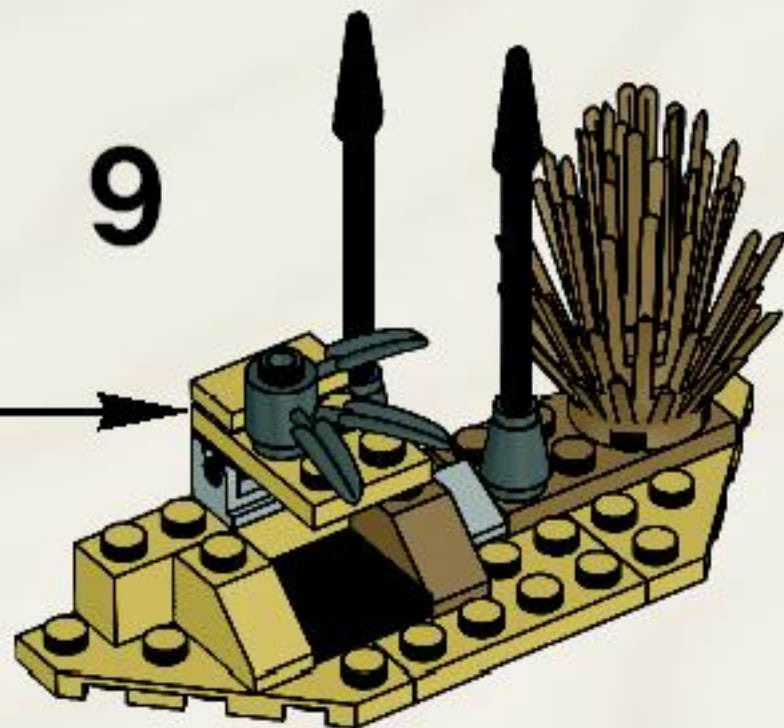
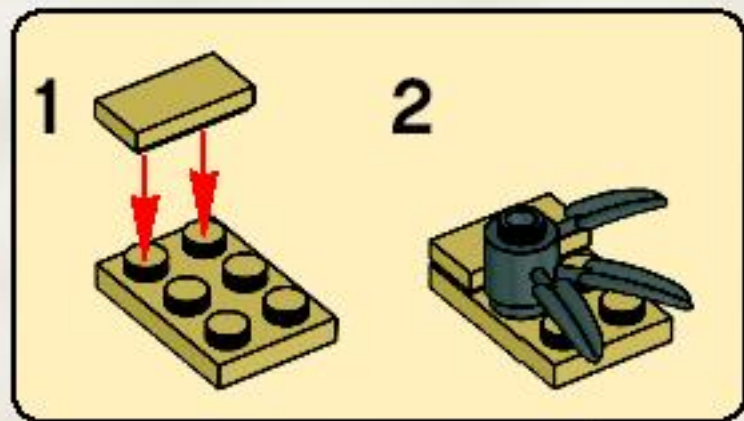

10

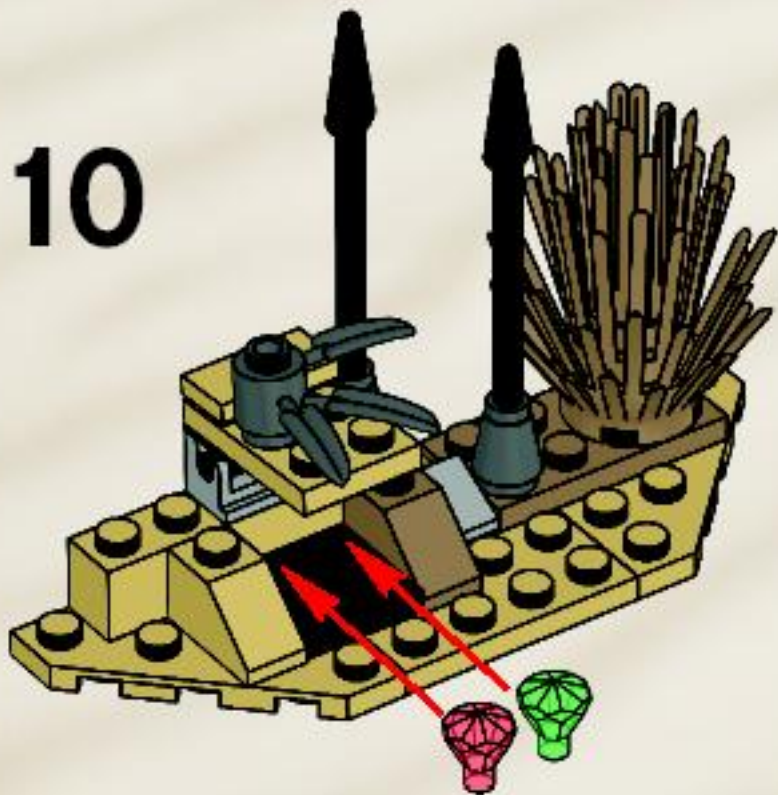

11

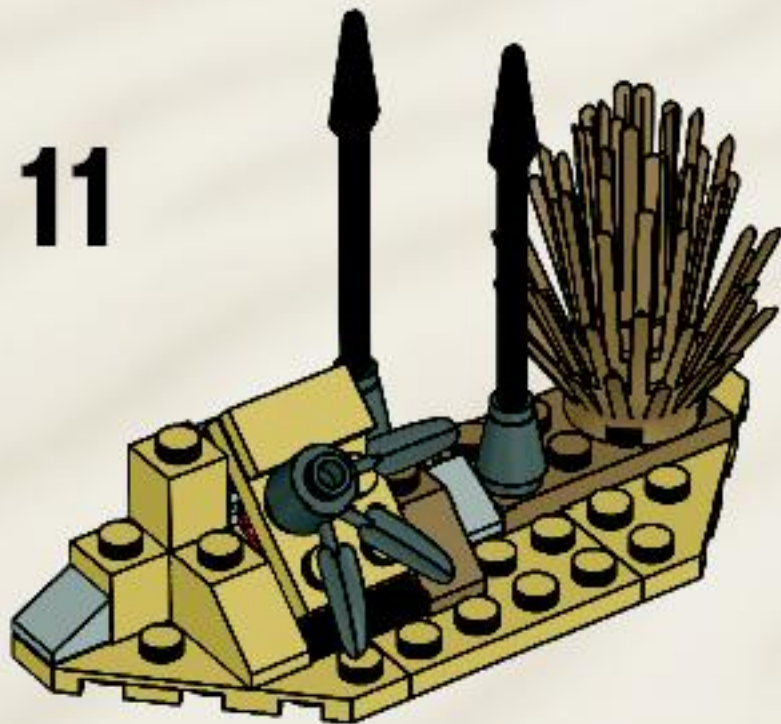





1x
300426

2x
4568949

1x
4580139

1x
4580484

2x
4142875

2x
4569474

1x 4113955 1x 4113954

1x
306926

1x
4551360

1x
4580165

1x
4568730

2x
626601

1x
4243824

1x
4594292

1x
4114052

1x
306826

1x
4580099

1x
4580101

1x
4568739

1x
4267874

1x
4113916

1x
4523032

1x
4568952

1x
393826

1x
9339

1x
4162916

1x
82359

1x
4530678

1x
4118790

2x
4529240

1x
4568934

1x
626001

1x
4211469

1x
4114026

2x
4273965

2x
4521921



Customer Service

Kundenservice

Service Consommateurs

Servicio Al Consumidor

www.lego.com/service or dial



00800 5346 5555 :

1-800-422-5346 :



1x
4594300

1x
4113915

2x
4121972



2x
4569471

1x
4569627



2x
4569625



1x
4538724

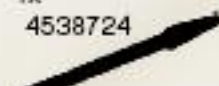

2x
4549898



1x
4594328

FREE! GRATIS! GRATUIT!



club
MAGAZINE™

www.LEGOclub.com



00800 5346 5555*        

  1-866-534-6258 • 1-877-518-5346

US & Canada only

Canada seulement

* Free phone. Mobile charges may apply. * Numéro sans frais. Des frais peuvent s'appliquer avec les téléphones cellulaires.

* Gebührenfrei. Kosten für Anrufe aus Mobilfunknetzen können anfallen. * Gratis telefonnummer från Fynskt län.

* Det er ett gratis nummer, når du ringer fra fasttelefon. * Det är gratis, när du ringer från fasttelefon.



VISIT THE WORLD'S
BIGGEST LEGO® SHOP!

www.LEGOshop.com



WIN!

Go to www.nielsen.com/LEGO to fill out a survey for a chance to win a cool LEGO® Product.

No purchase necessary.

Open to all residents where not prohibited.



www.nielsen.com/LEGO

GEWINNE!

Nimm an der Umfrage auf www.nielsen.com/LEGO teil und hab die Chance ein cooles LEGO® Produkt zu gewinnen!

Die Teilnahme am Gewinnspiel führt zu keinen Kaufverpflichtungen. Teilnahme in allen nicht ausgeschlossenen Ländern möglich.

WIN!

Ga naar www.nielsen.com/LEGO, vul een enquêteformulier in en maak kans op een cool LEGO® product. Geen aankoopverplichting. Iedereen mag deelnemen, uitgezonderd ingezetenden van landen waar een enquêteverbod geldt.

GAGNE!

Visite www.nielsen.com/LEGO pour répondre à un questionnaire et avoir une chance de gagner un produit LEGO® très cool! Aucune obligation d'achat. Ouvert à tous les résidents des pays autorisés.

当てよう!

www.nielsen.com/LEGO にアクセスして、アンケートにご記入ください。当選者にはレゴ製品を差し上げます。お買い上げの金額は問いません。抽選されています。すべての条件にご注意ください。

LEGO and the LEGO logo are trademarks of the LEGO Group. ©2010 The LEGO Group.

©Disney Enterprises, Inc. and Jerry Bruckheimer, Inc.

©2010 Lucasfilm Ltd. & TM. All rights reserved. Used under authorization.