



RACERS

7967



1

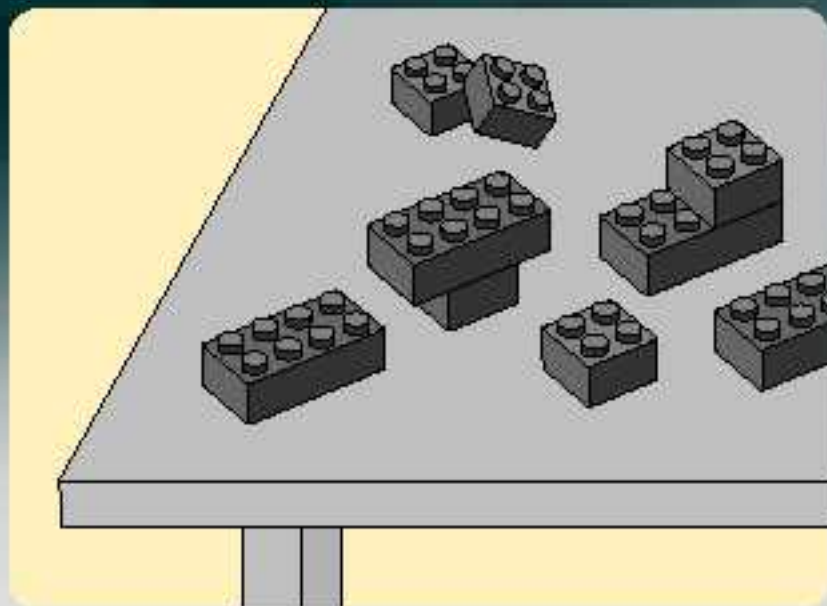

2





1

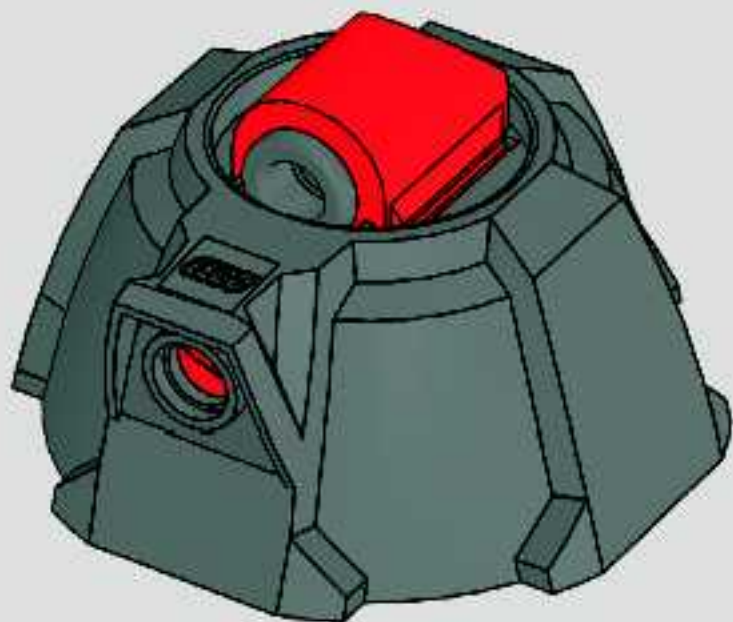

2

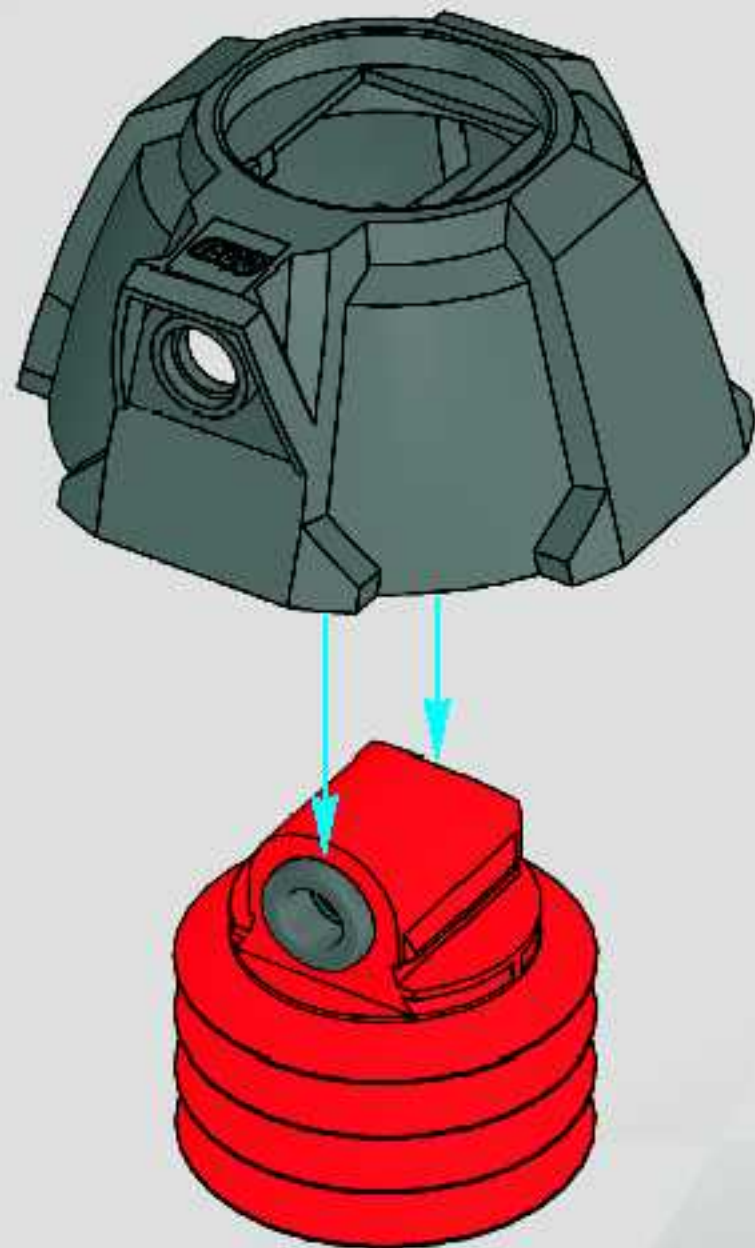

3

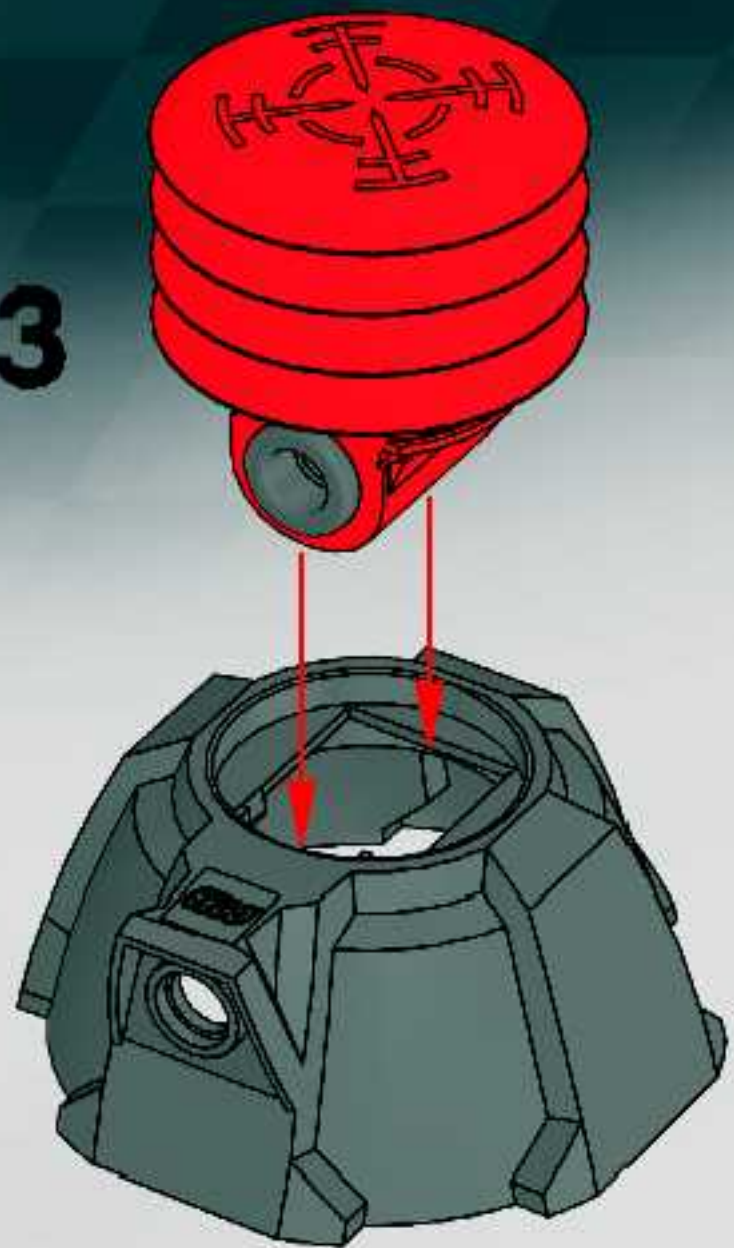

4

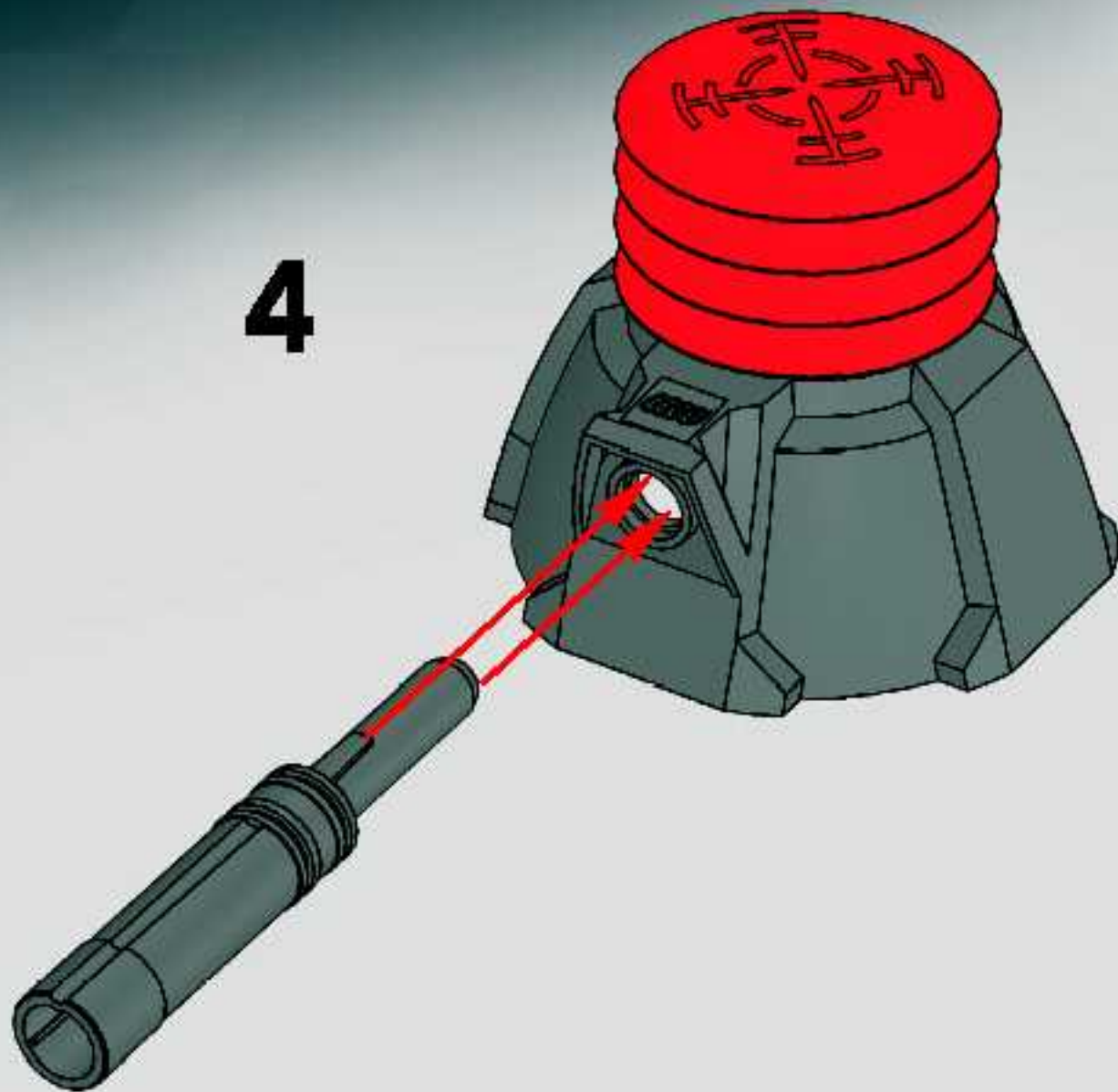

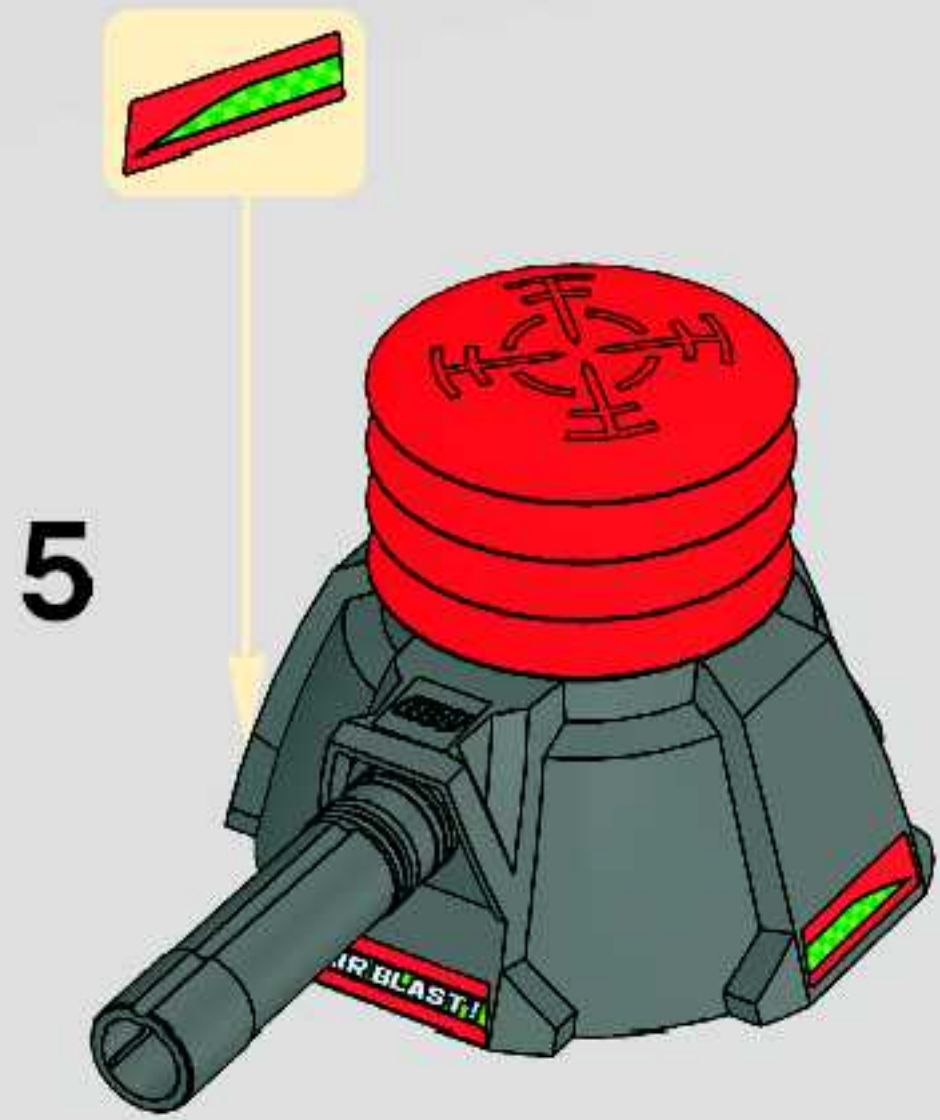



1

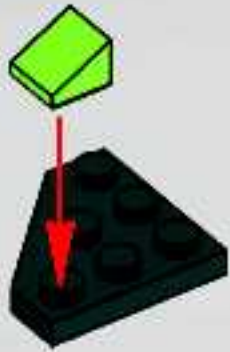

2



3

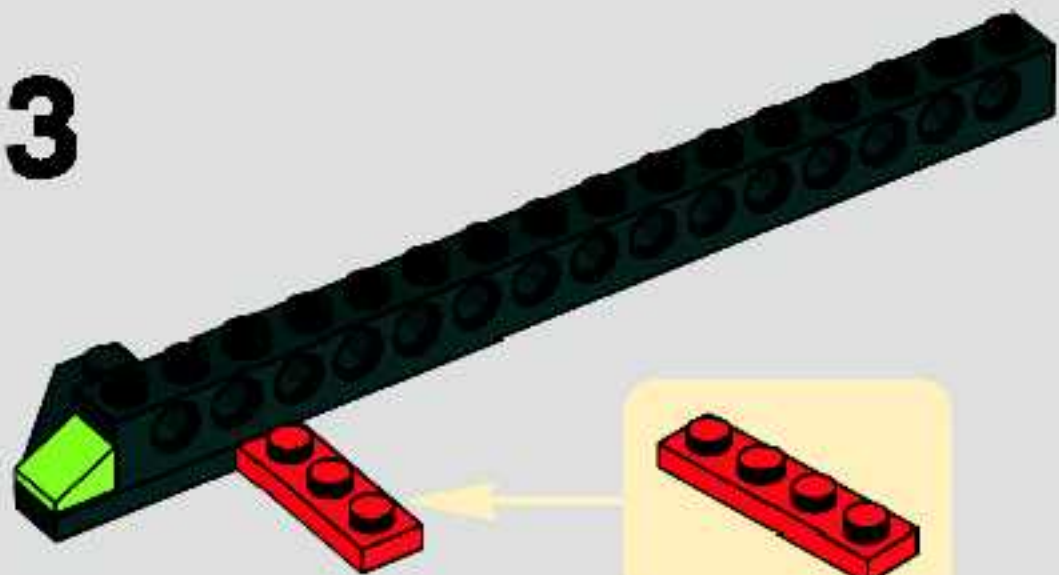

4

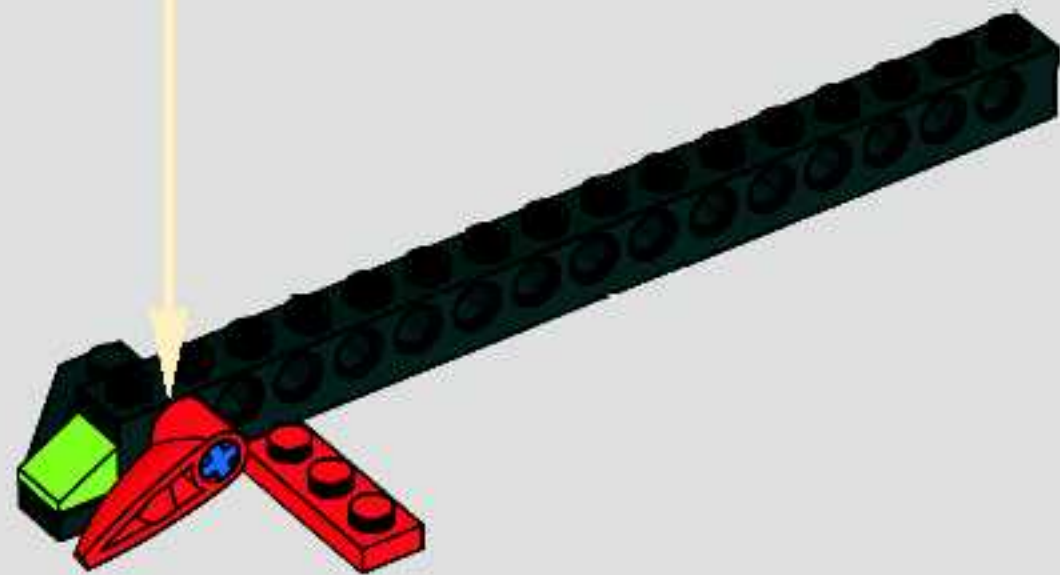
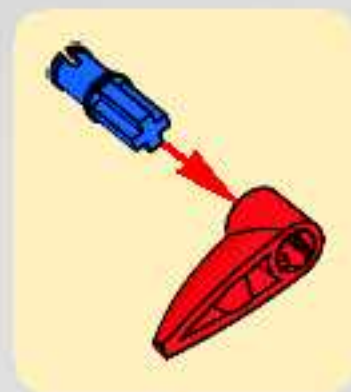

1



2

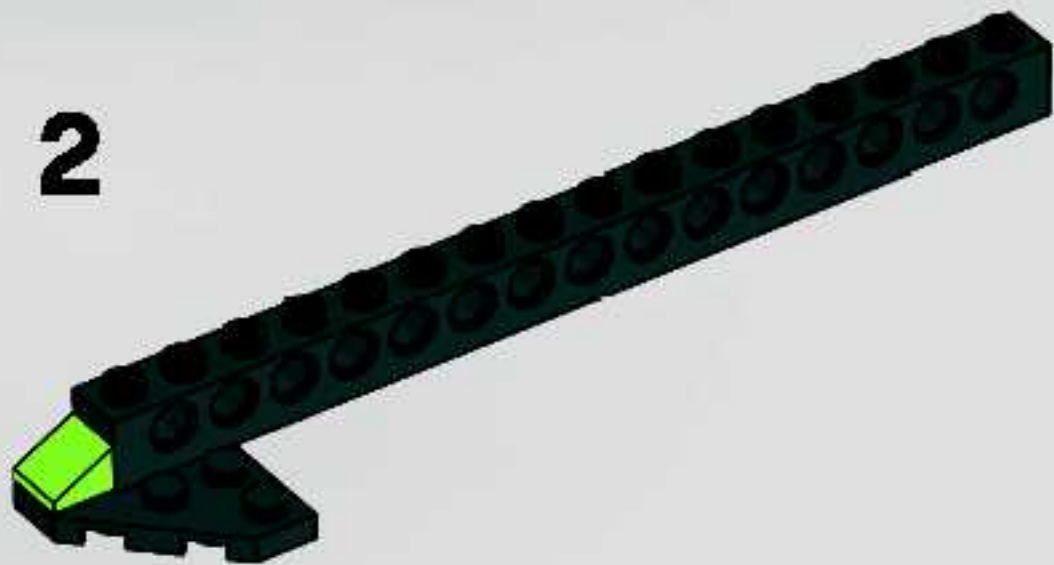

8

3

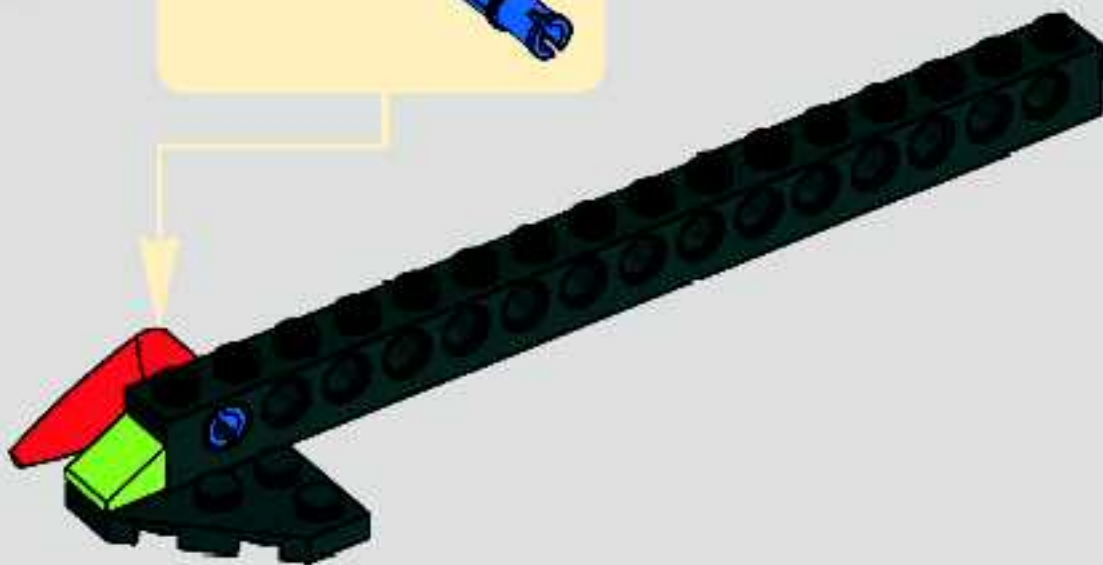
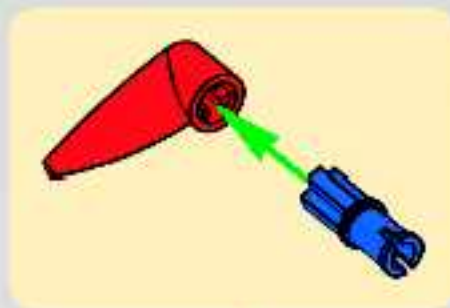

5

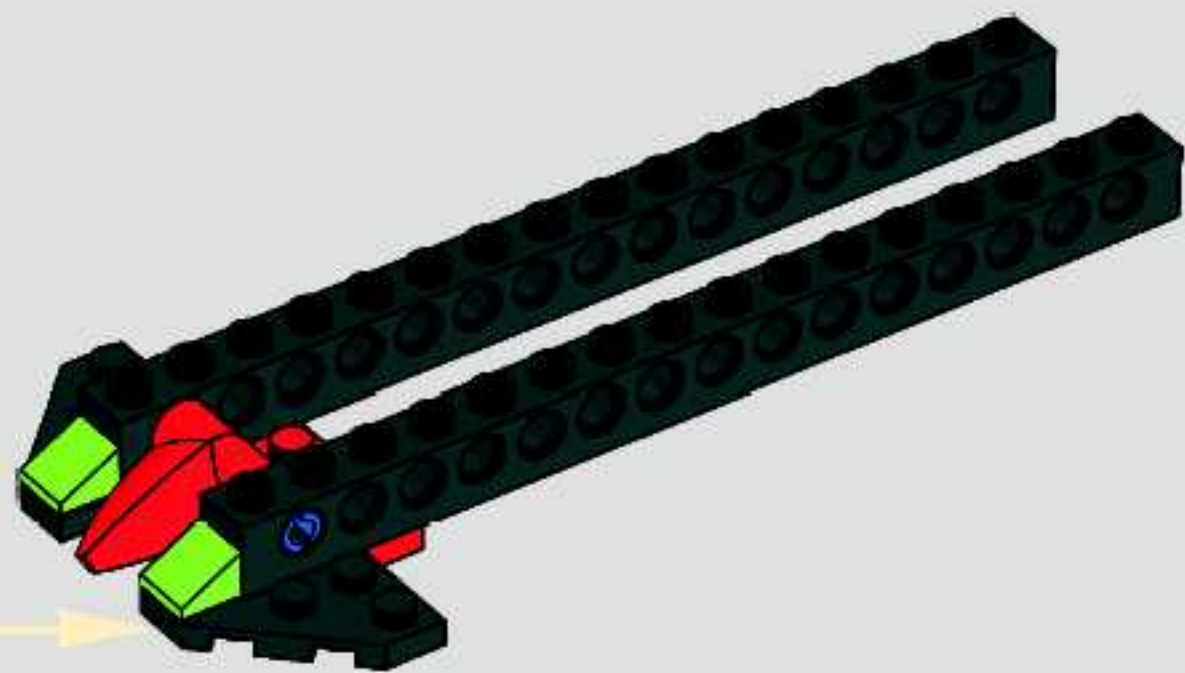



6

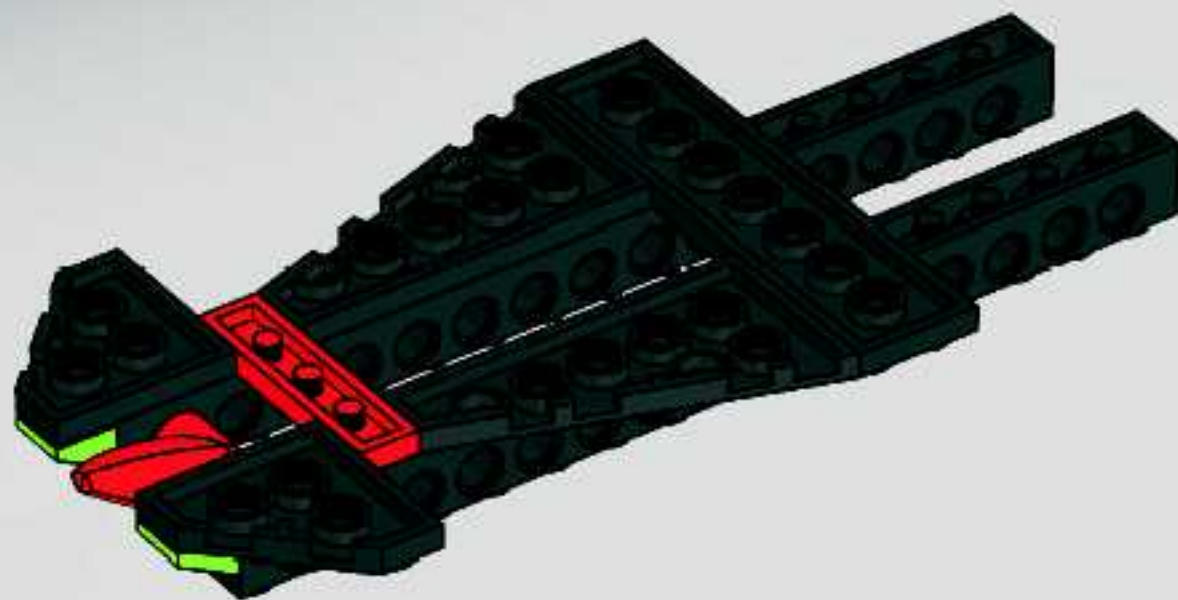

7

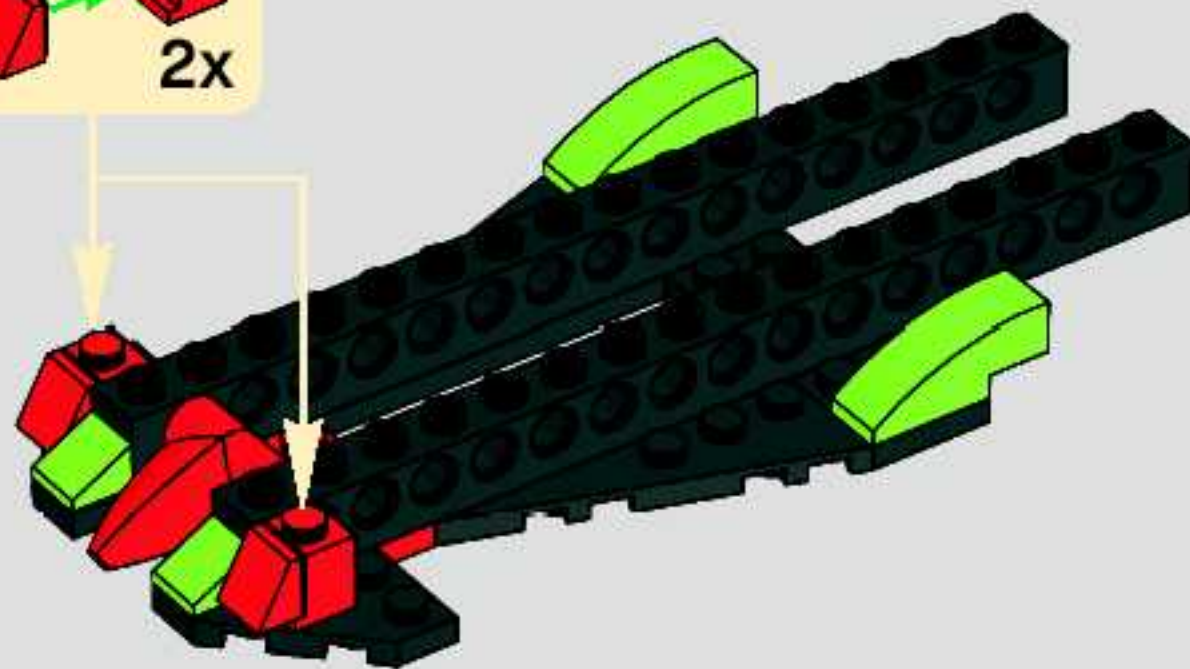
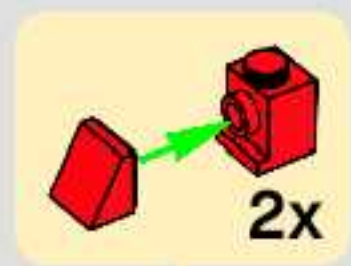

8

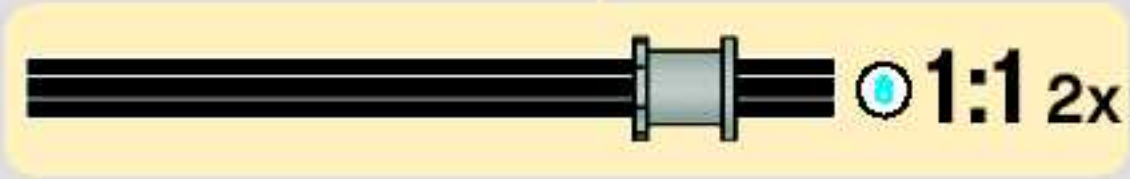
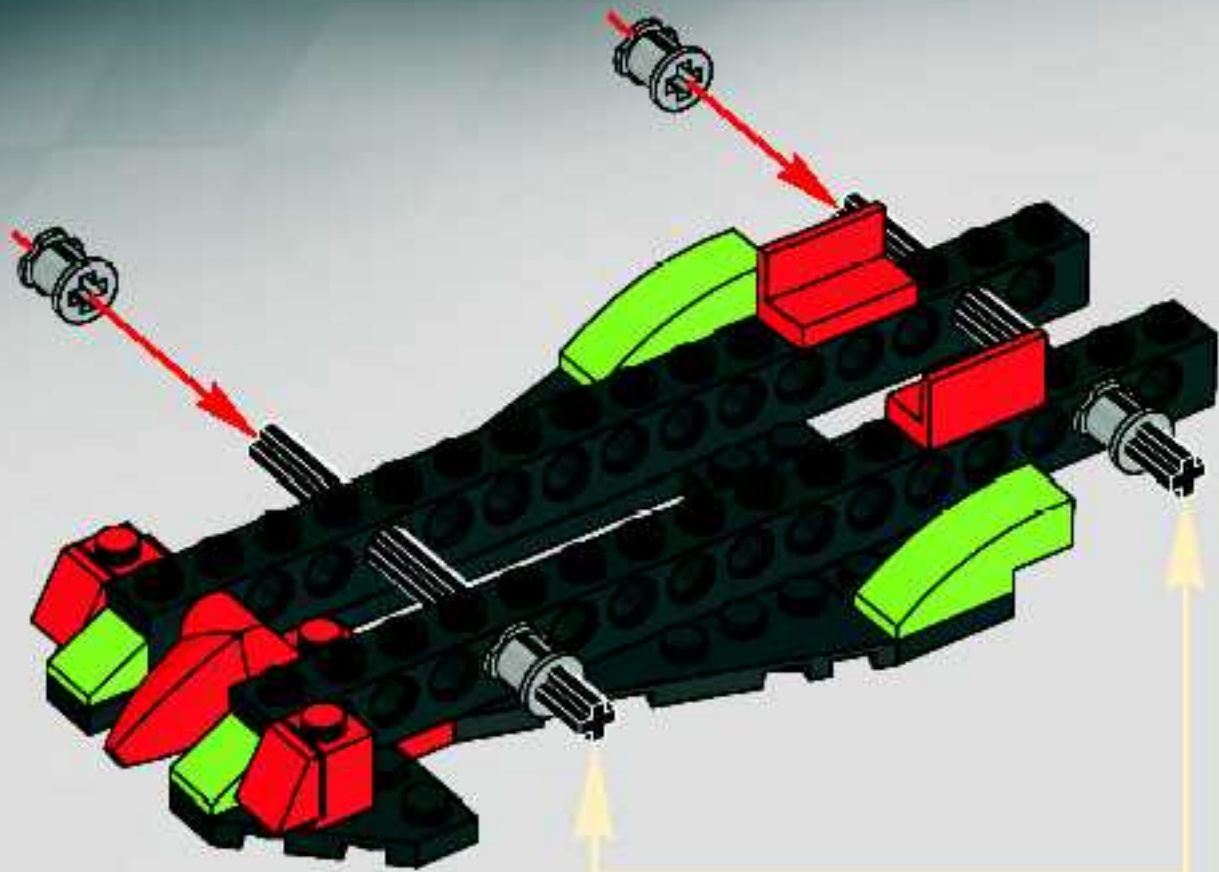

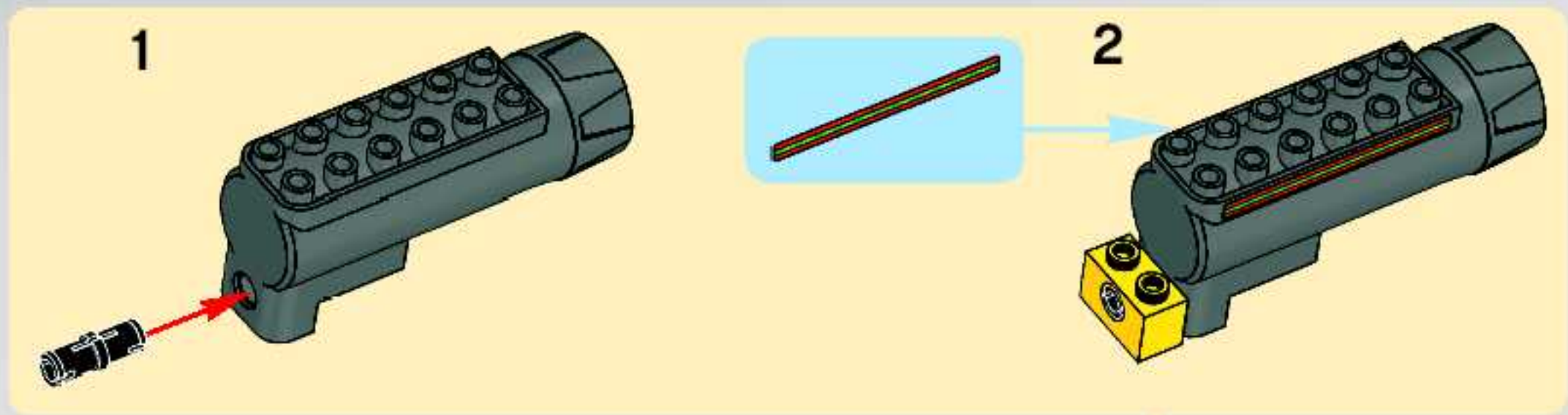

9

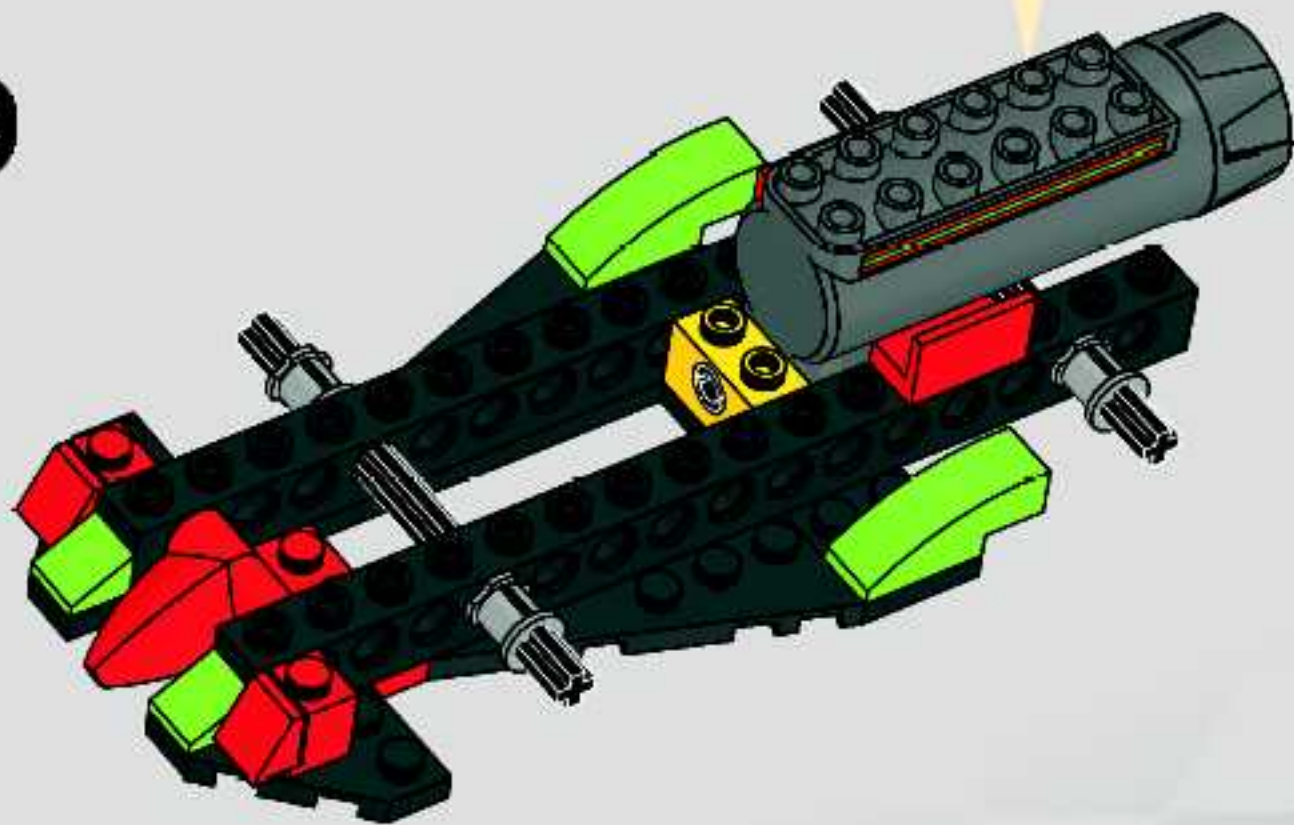

10

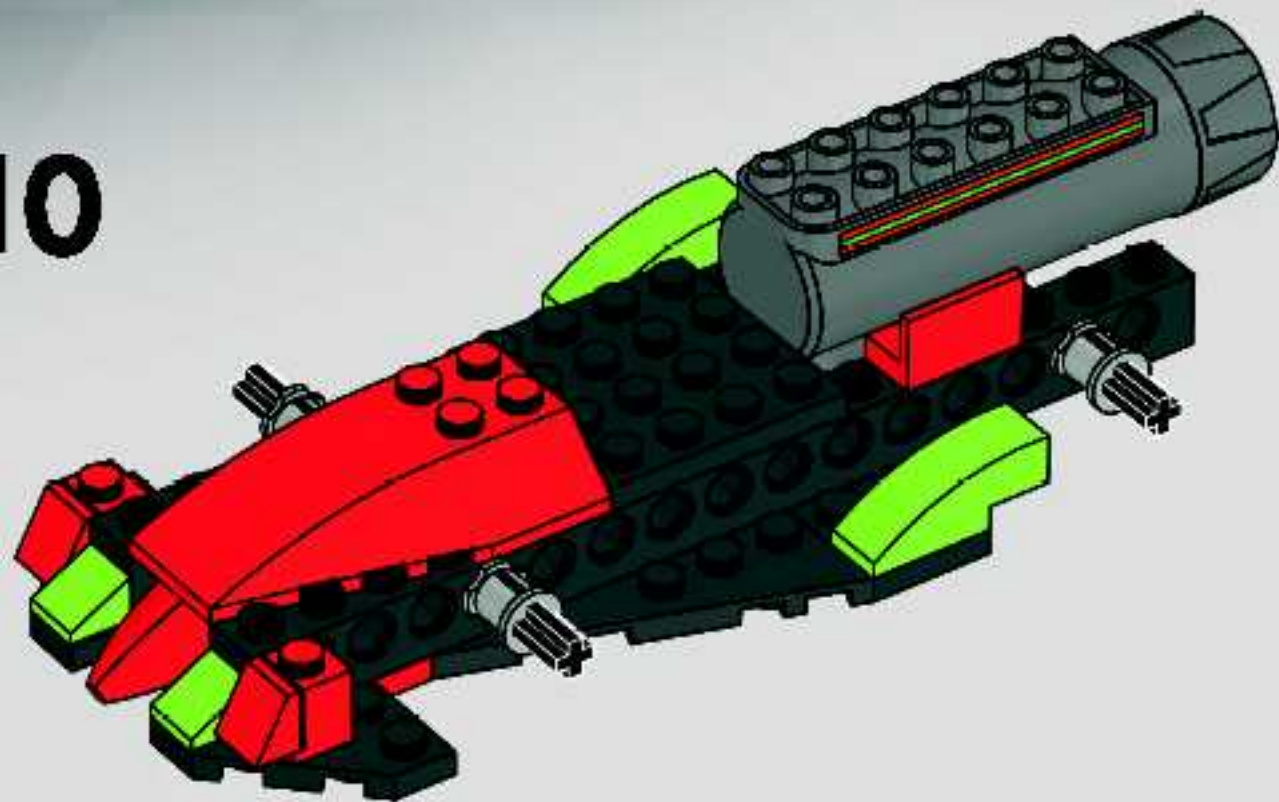

11

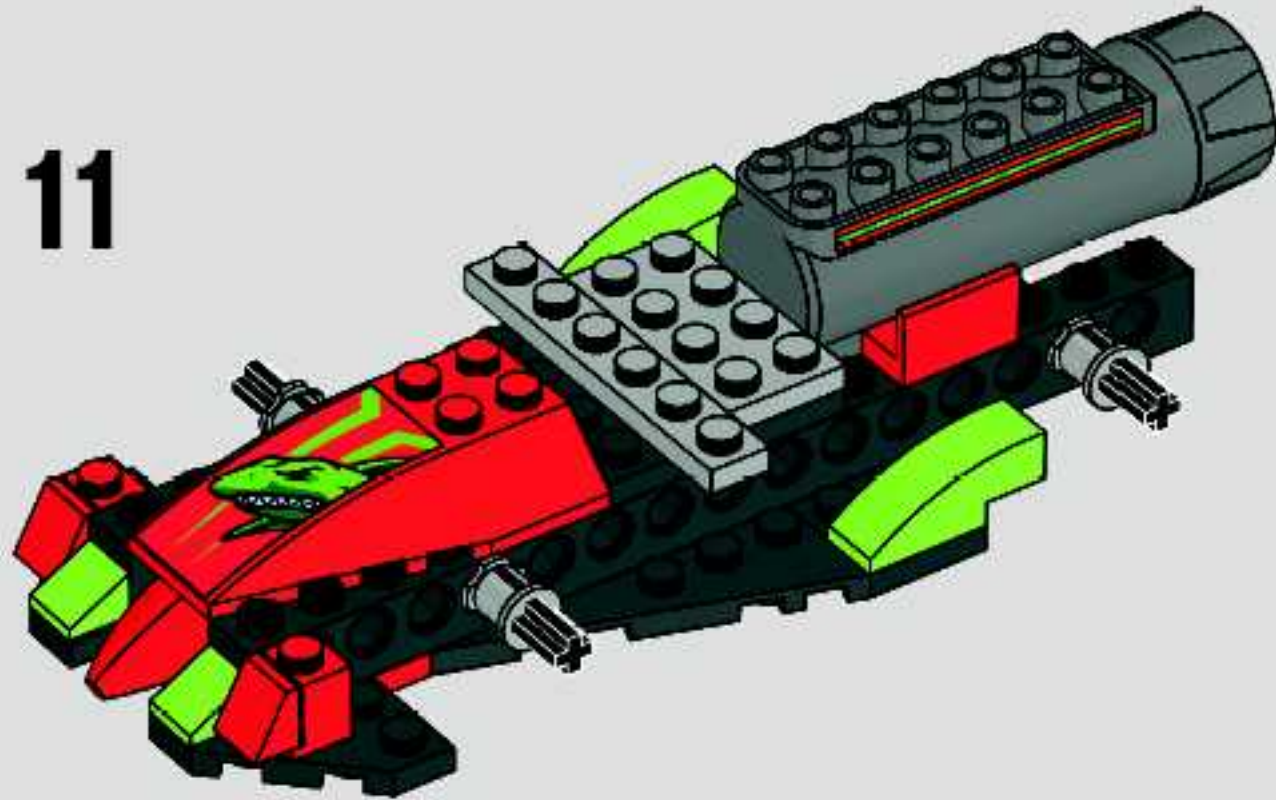

12

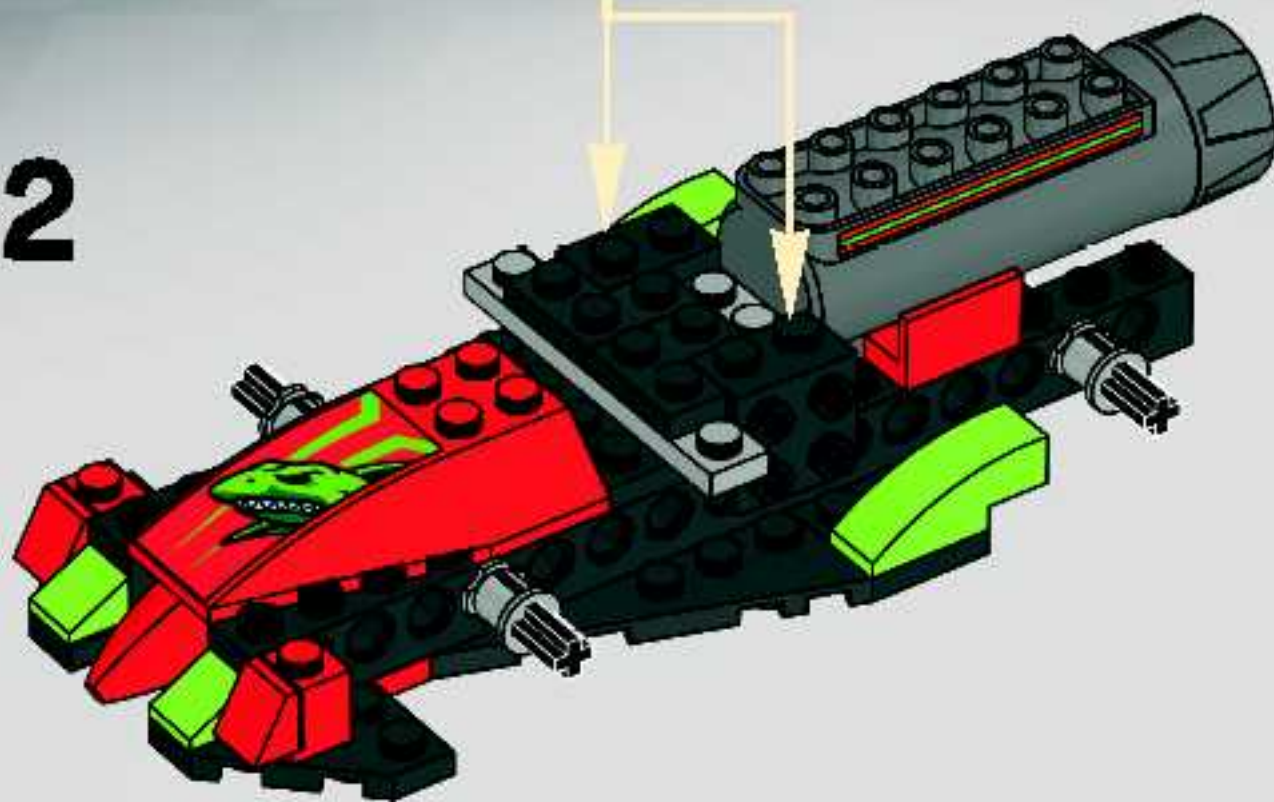
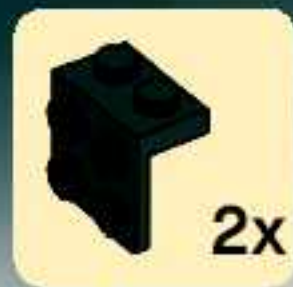

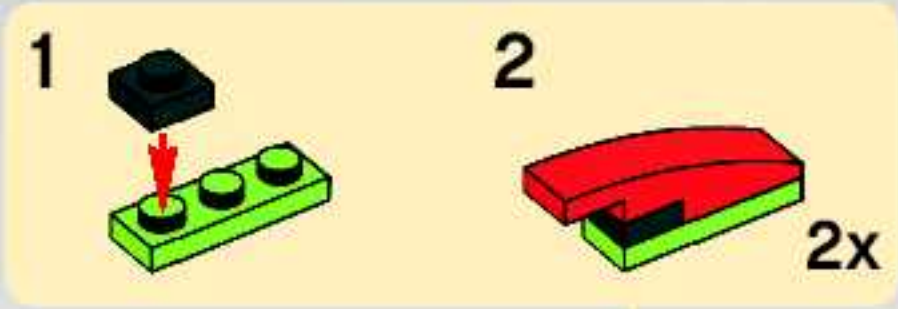

13

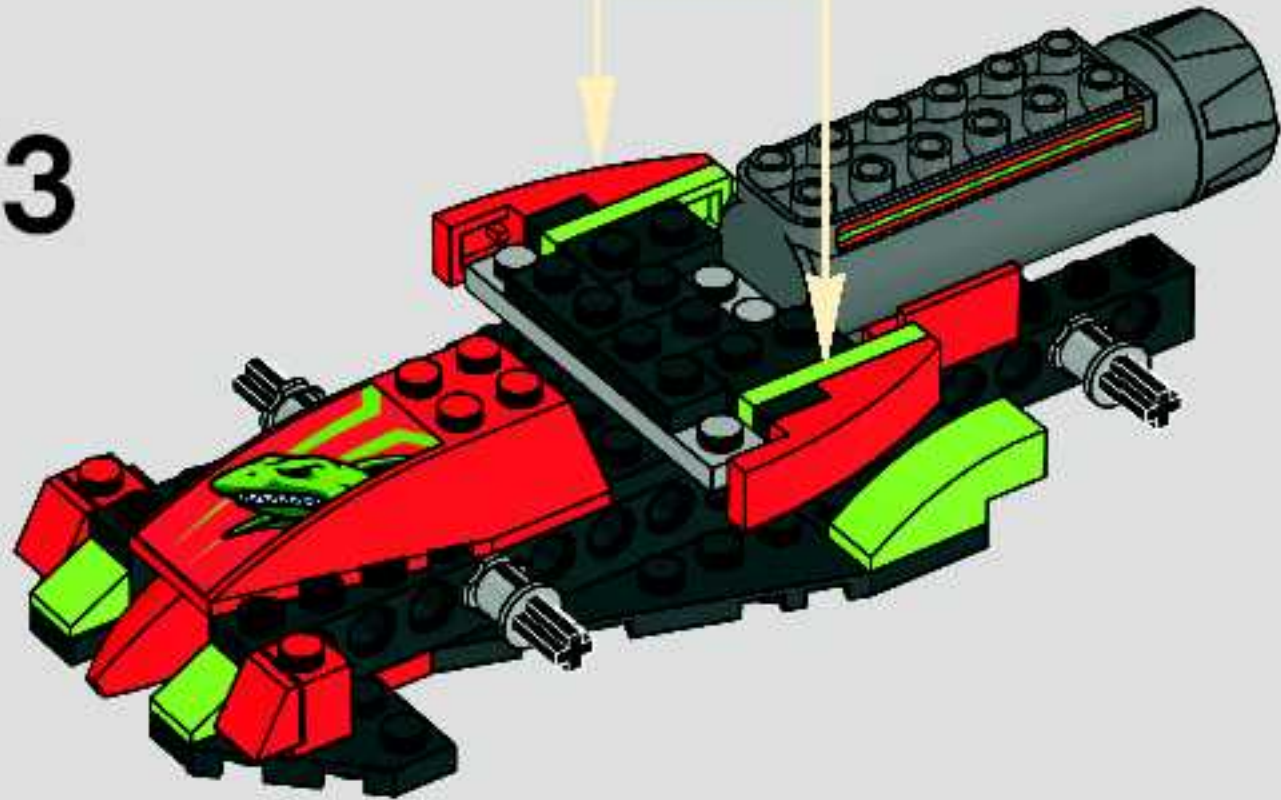

14

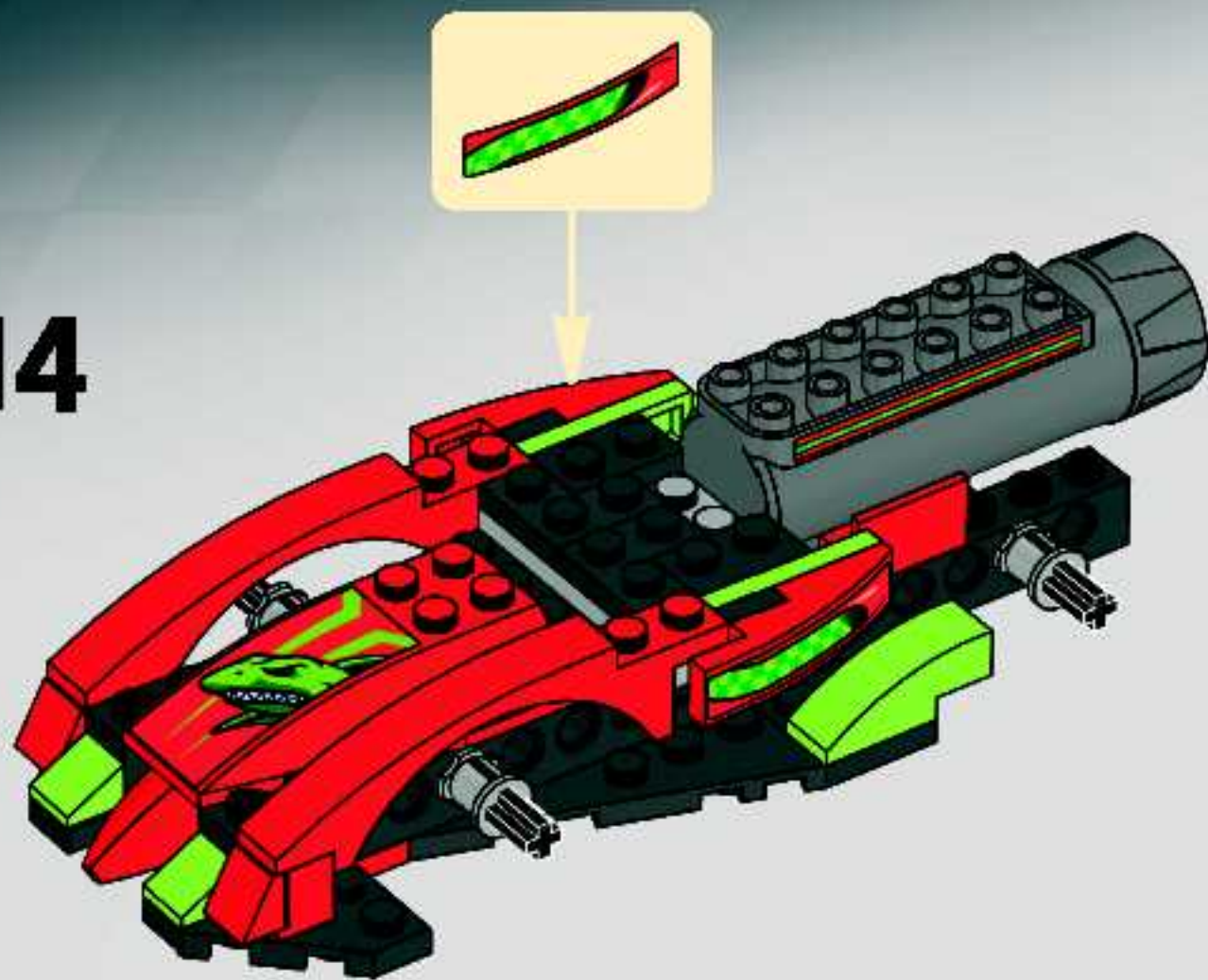

15

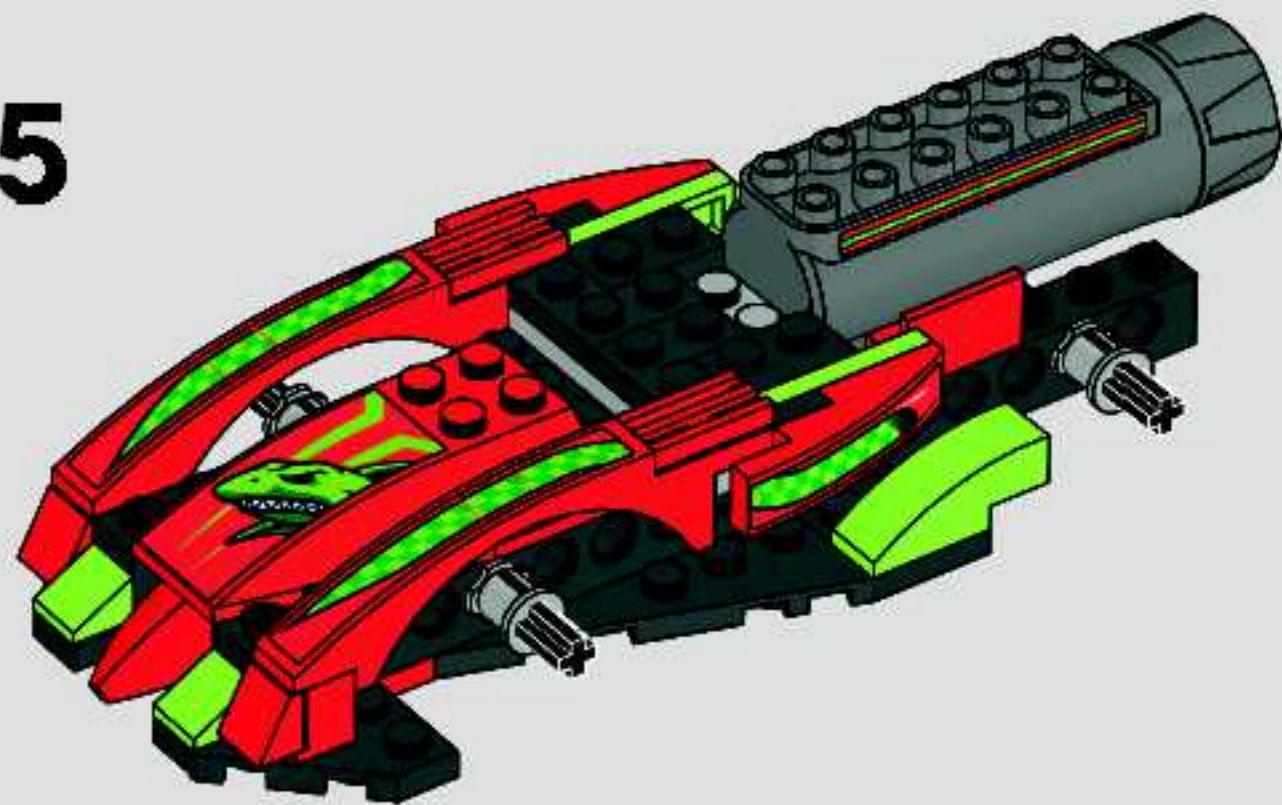



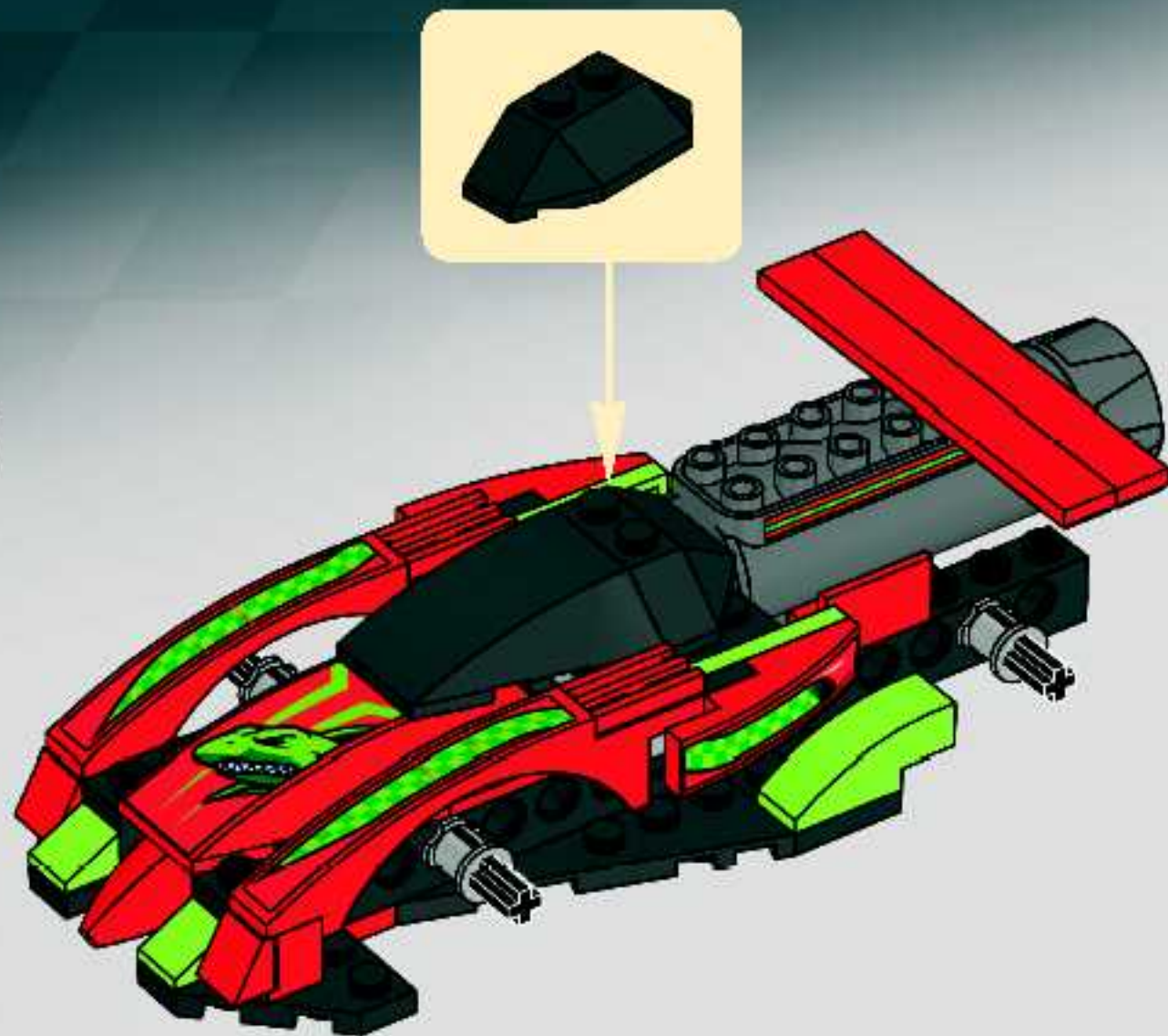



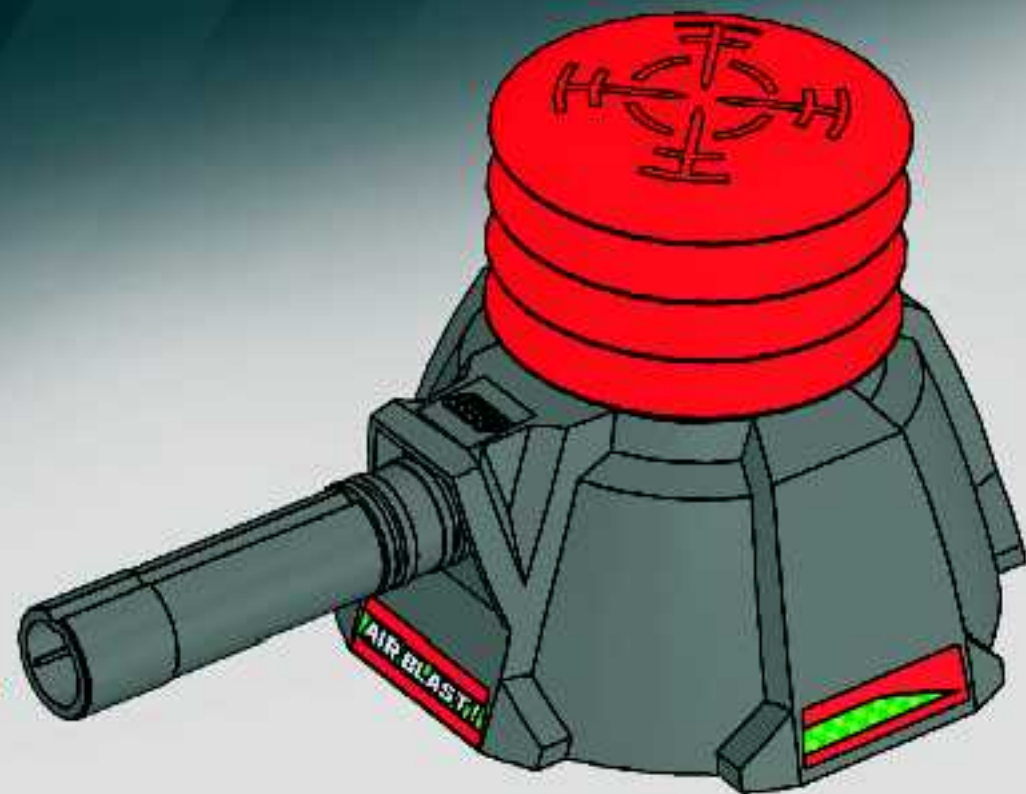

16



18





-  2x
241221
-  1x
371021
-  2x
407021
-  2x
416221
-  2x
486521
-  2x
4185661
-  1x
4568967
-  2x
4504379
-  2x
4520782
-  2x
4247772

-  1x
4568690
-  2x
4206482
-  1x
370024
-  2x
242026
-  2x
4227684
-  1x
4121715
-  2x
302426
-  1x
303426

-  1x
4243819
-  2x
370726
-  2x
4277932
-  1x
4219107
-  1x
4213298
-  4x
4517737
-  4x
4550937
-  2x
370326

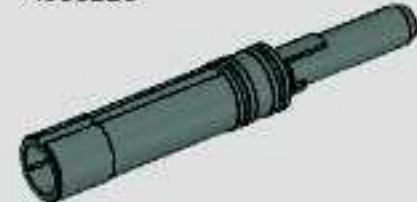
-  1x
4283047
-  1x
4283046
-  2x
4210210
-  2x
4504372
-  2x
4537928
-  1x
4211438
-  4x
4211622
-  1x
4211395
-  4x
4527058

-  1x
4563226
-  1x
4568692
-  1x
4563215



Customer Service
Kundenservice
Service Consommateurs
Servicio Al Consumidor

www.lego.com/service or dial

							
					: 00800 5346 5555		
		: 1-800-422-5346					



WIN!

Go to www.nielsen.com/LEGO
to fill out a survey for a chance
to win a cool LEGO® Product.

No purchase necessary.

Open to all residents where not prohibited.



www.nielsen.com/LEGO

GEWINNE!

Nimm an der Umfrage auf
[www.nielsen.com/](http://www.nielsen.com/LEGO)
LEGO teil und hab die Chance ein cooles
LEGO® Produkt zu gewinnen!

Die Teilnahme am Gewinnspiel führt zu keinerlei
Kaufverpflichtungen. Teilnahme in allen nicht
ausgeschlossenen Ländern möglich.

WIN!

Ga naar www.nielsen.com/LEGO,
vul een enquêteformulier in en
maak kans op een
cool LEGO® product.

Geen aankoopverplichting.

Iedereen mag deelnemen, uitzonderd
Ingezetenden

van landen waar een enquêteverbod geldt.

GAGNE!

Visite www.nielsen.com/LEGO
pour répondre à un questionnaire
et avoir une chance de gagner
un produit LEGO® très cool!

Aucune obligation d'achat.

Ouvert à tous les résidents des pays
autorisés.

当てよう!

www.nielsen.com/LEGO
にアクセスして、
アンケートにご記入ください。
当選者にはレゴ製品を
差し上げます。

お買い上げの必要はありません。

禁止されていない限り、すべての年齢にご利用いただけます。