

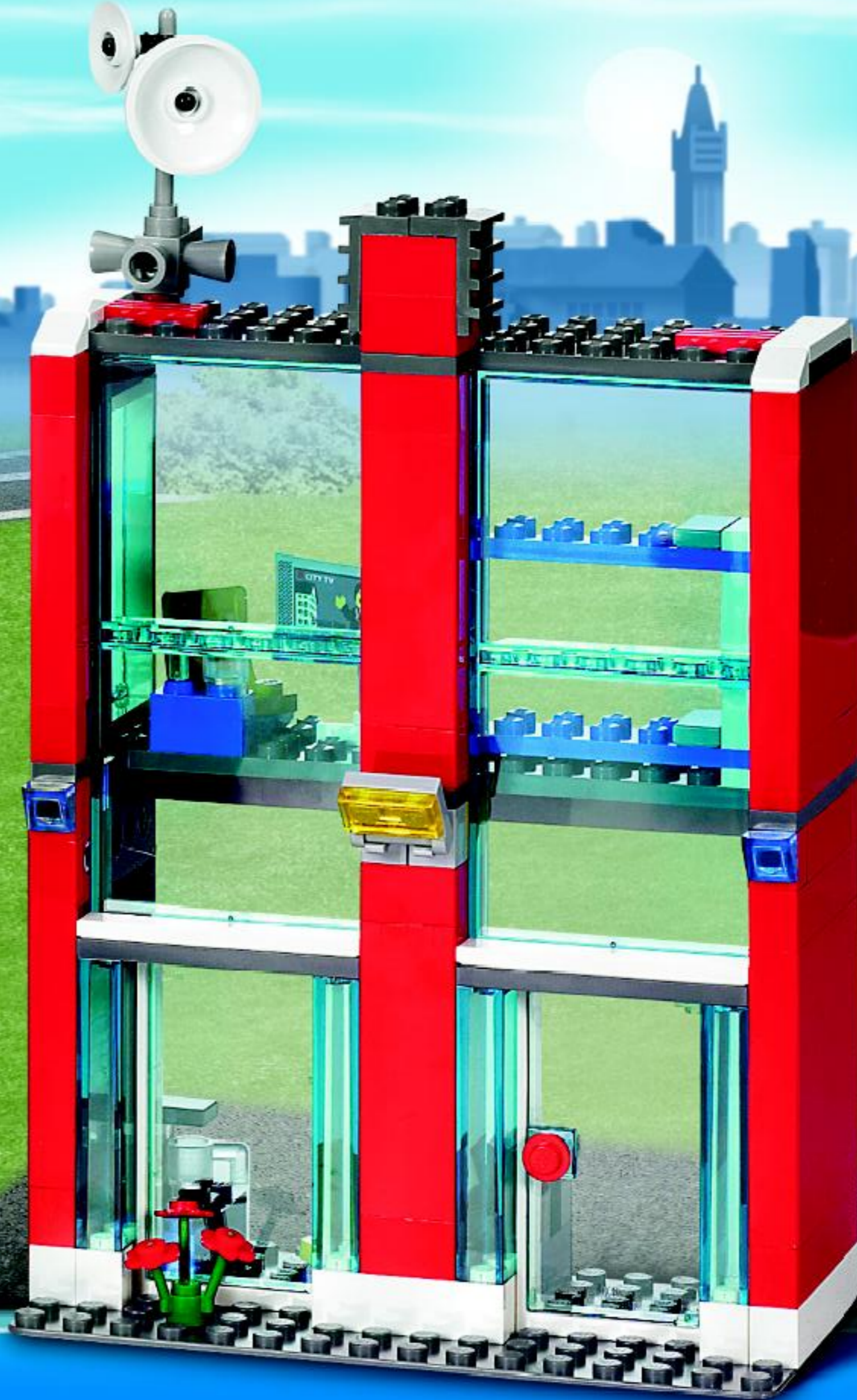

7208

# CITY





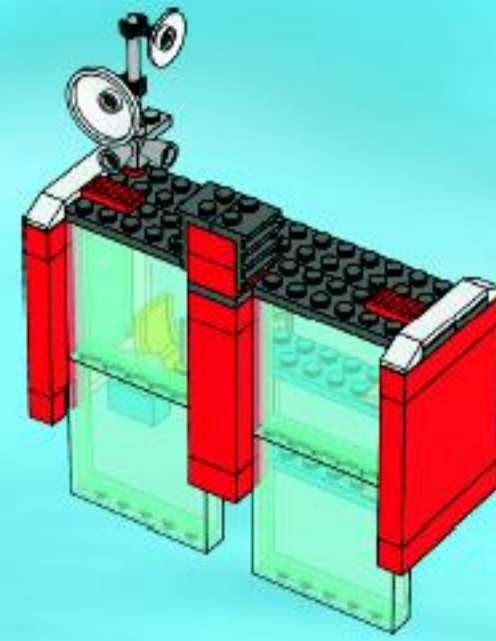
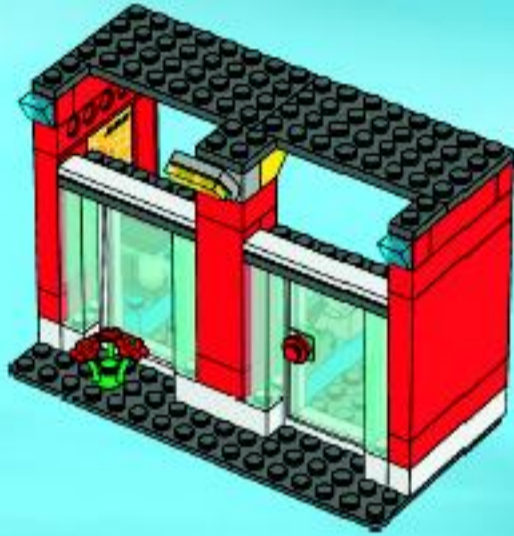

+

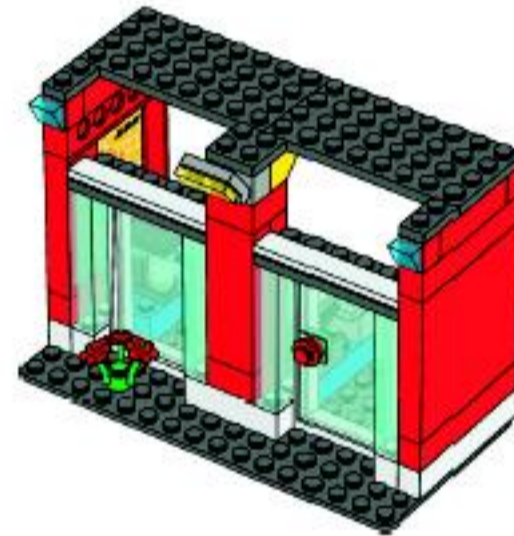

1

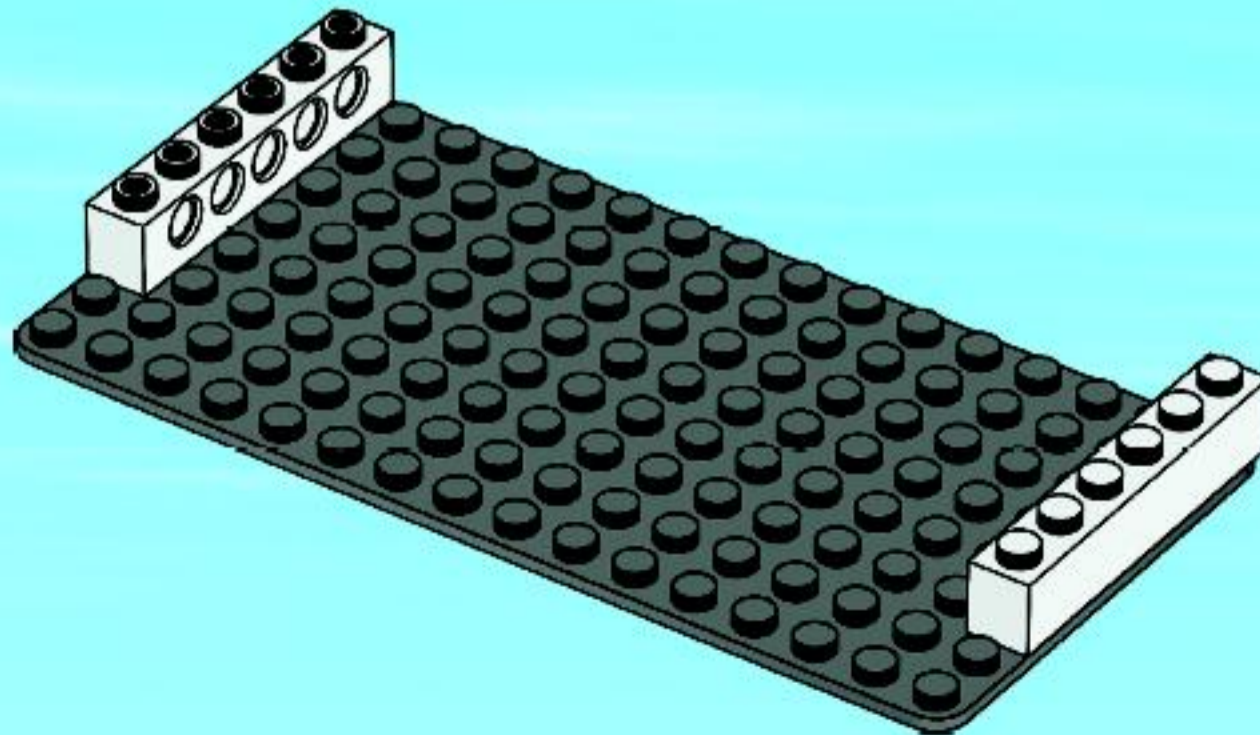



2

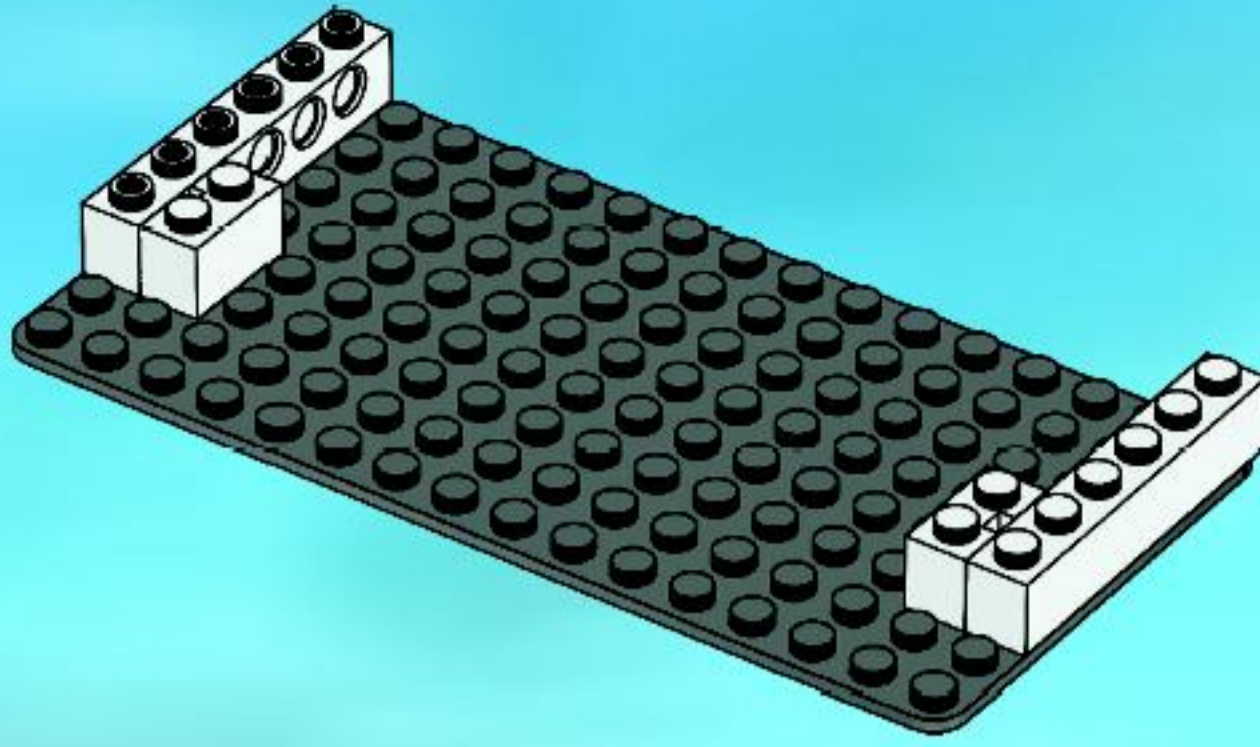

3

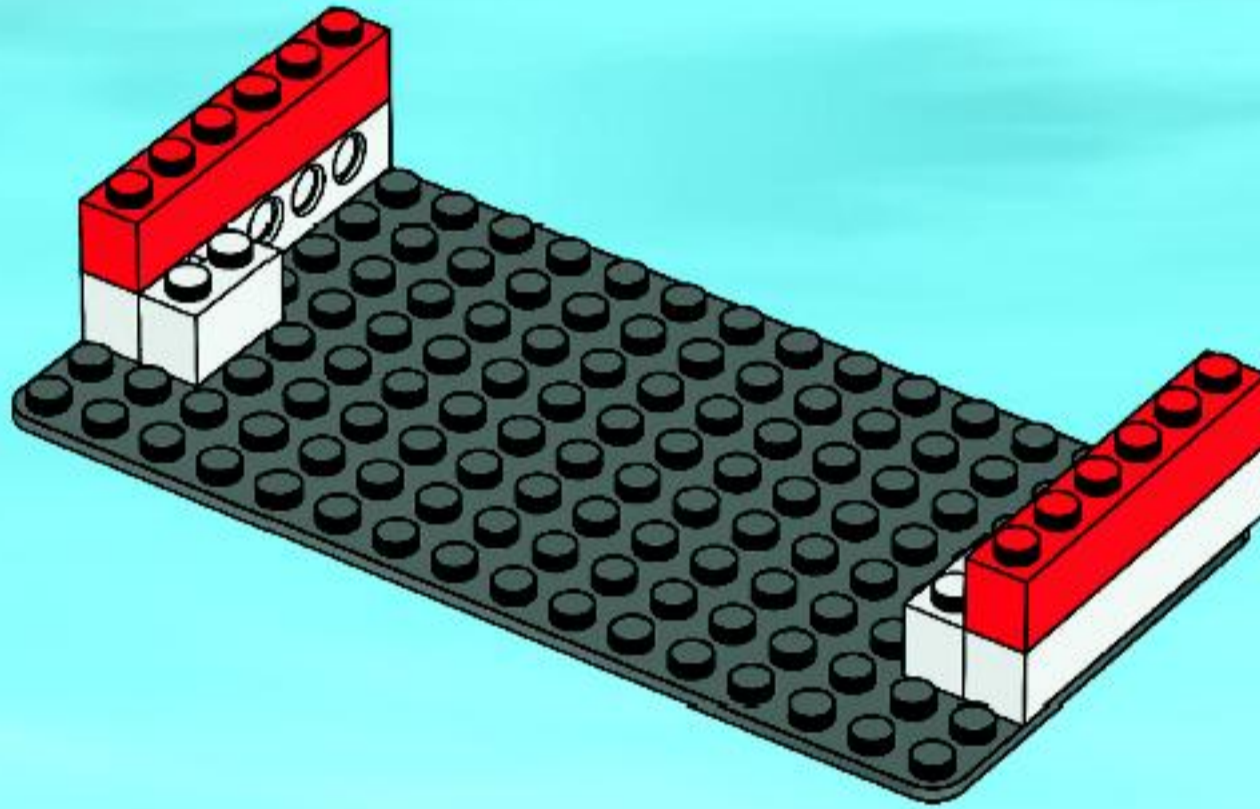

4

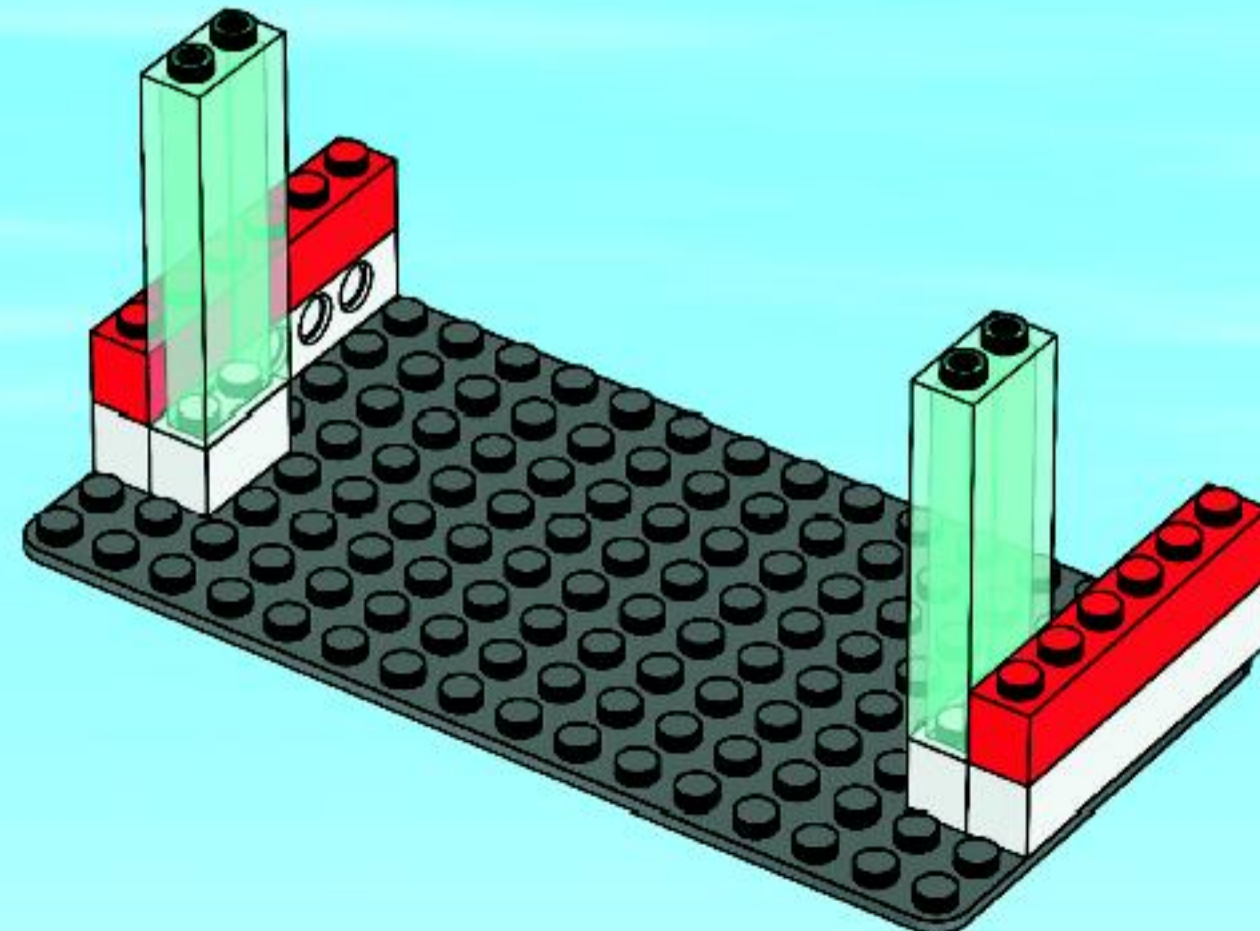



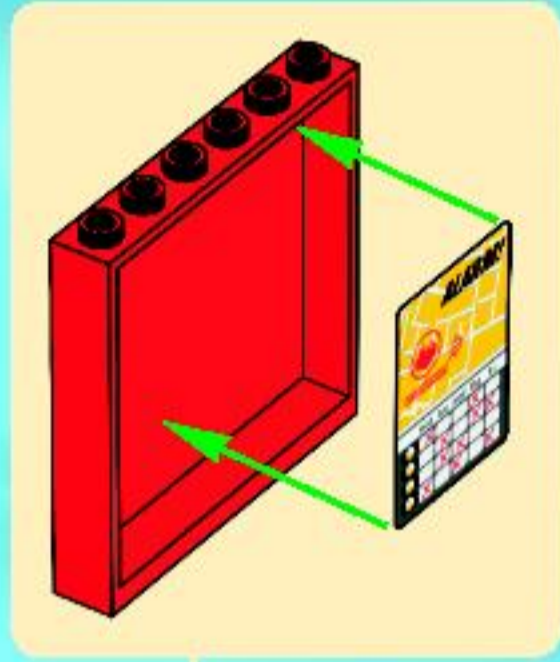

5

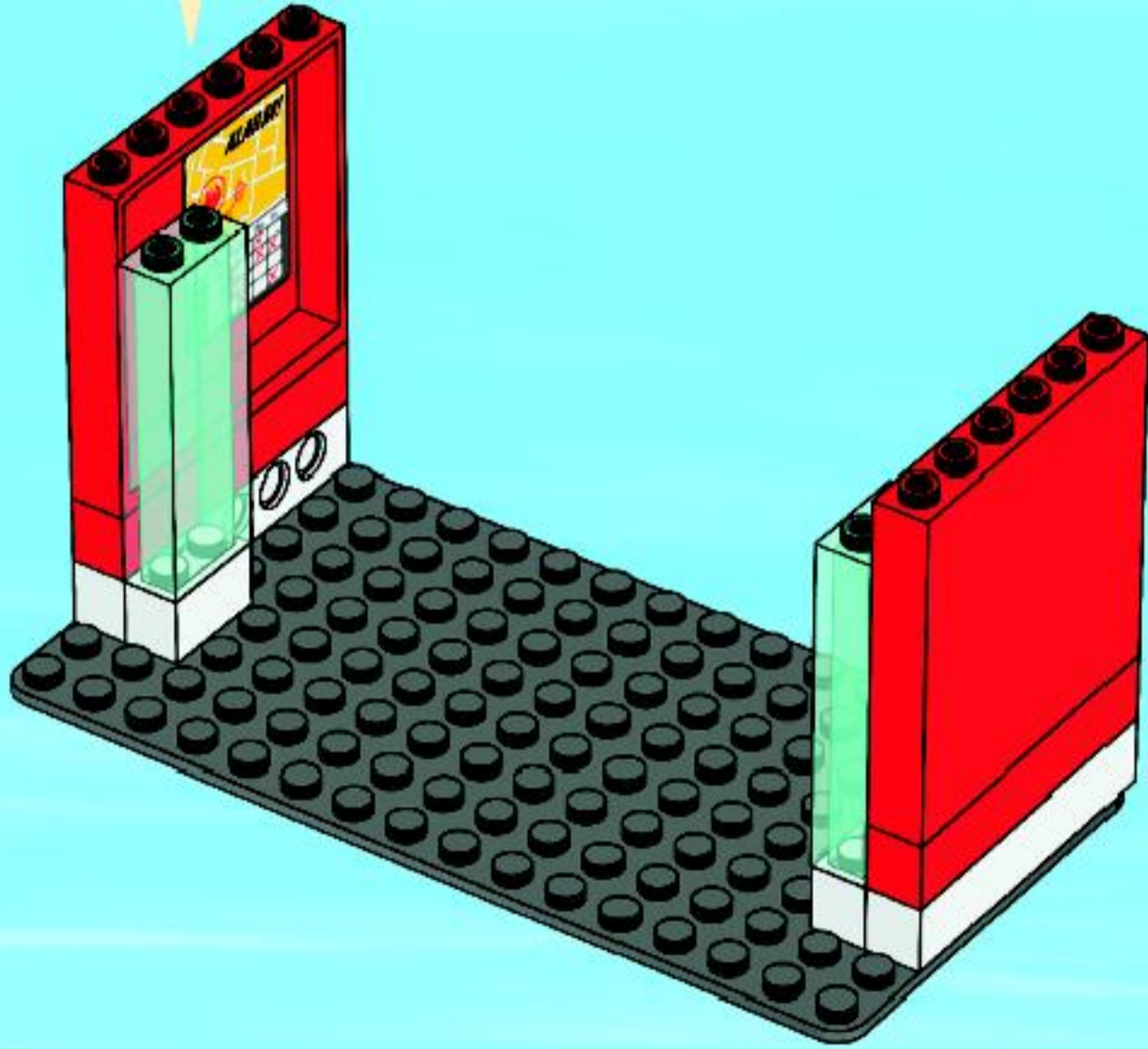

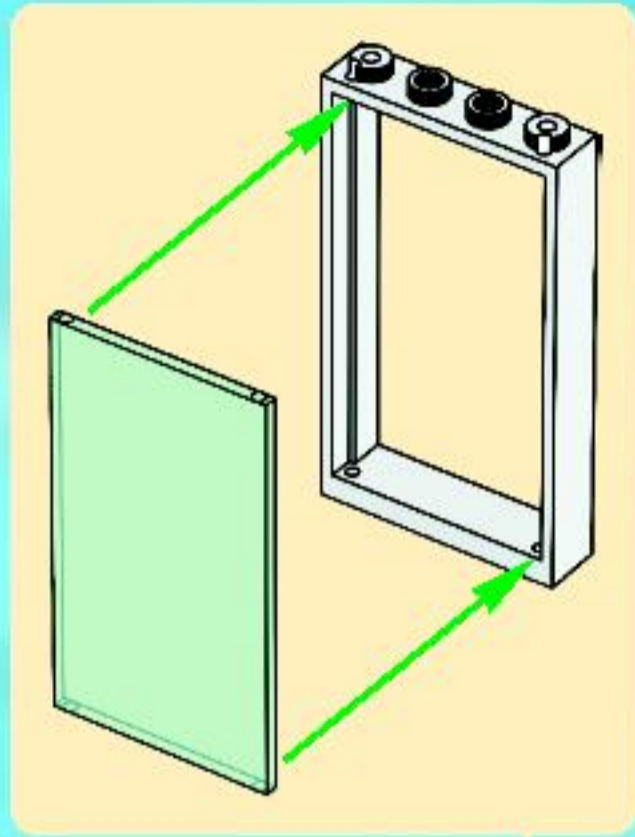

6

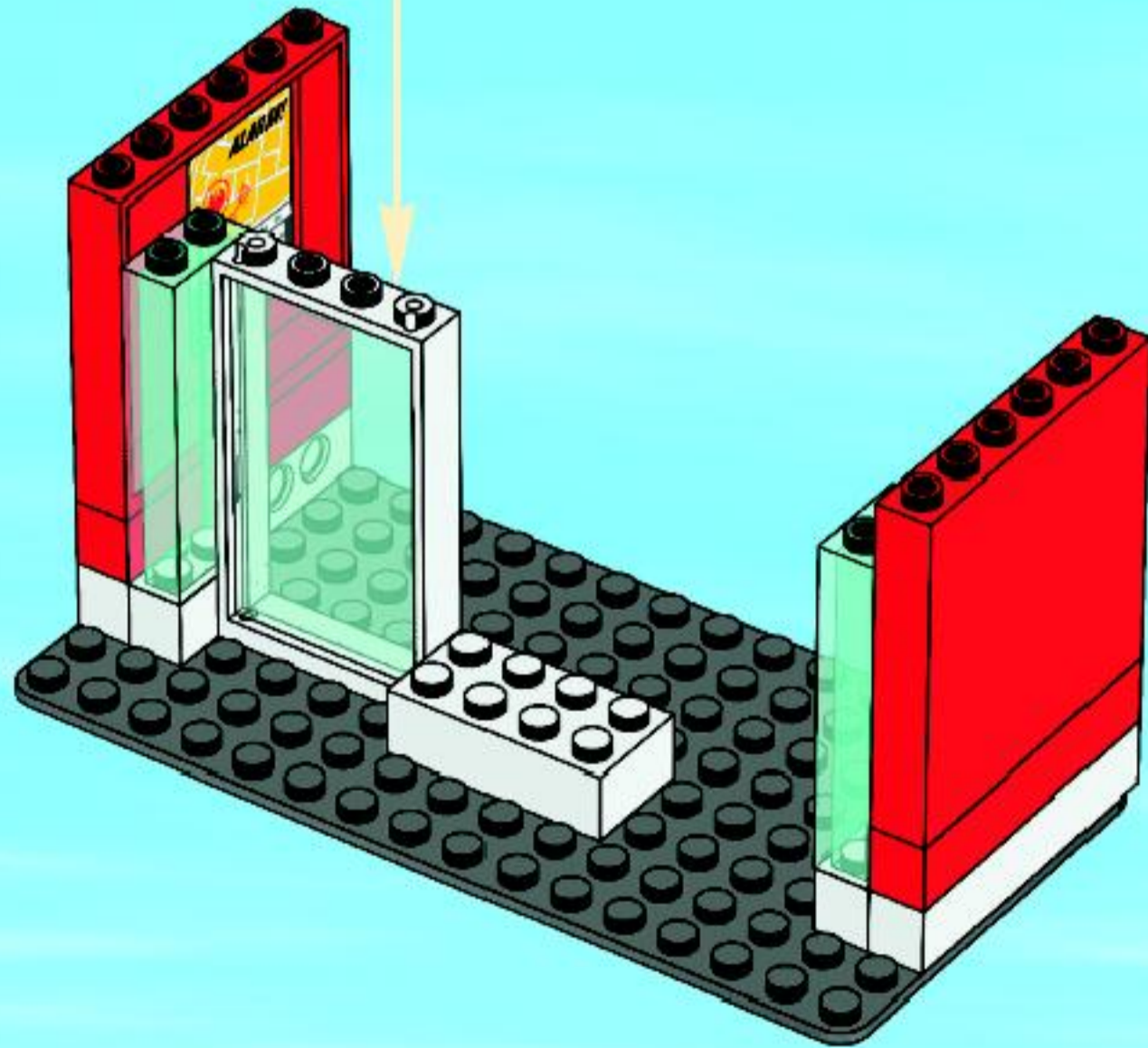



7

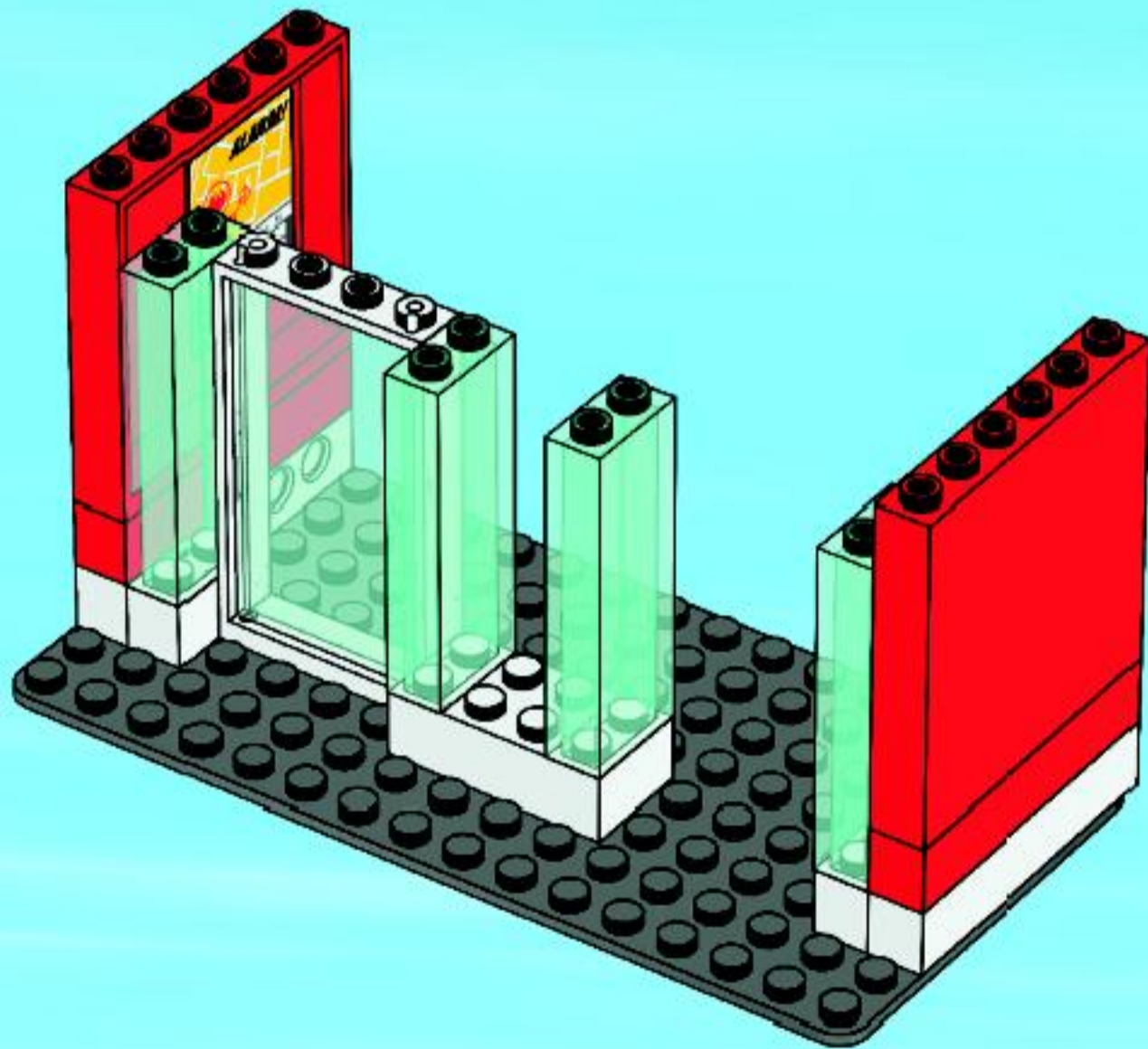

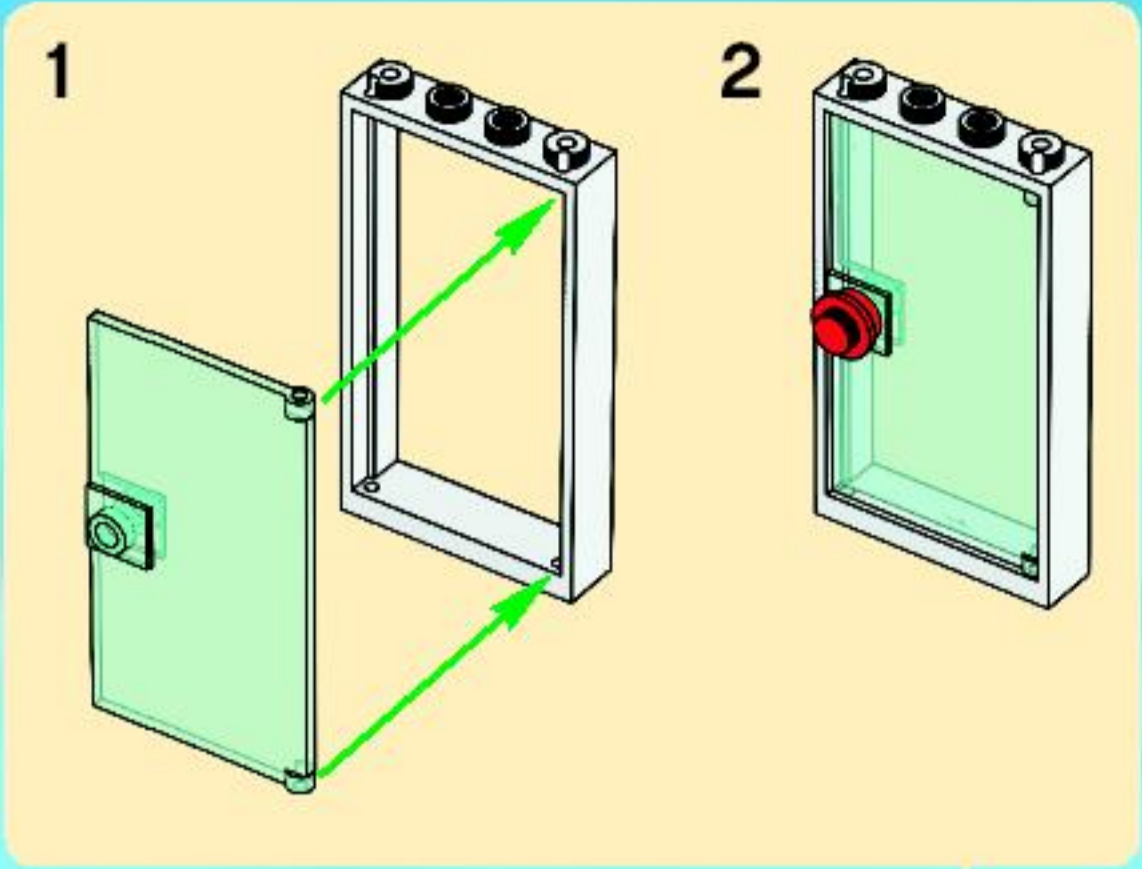

8

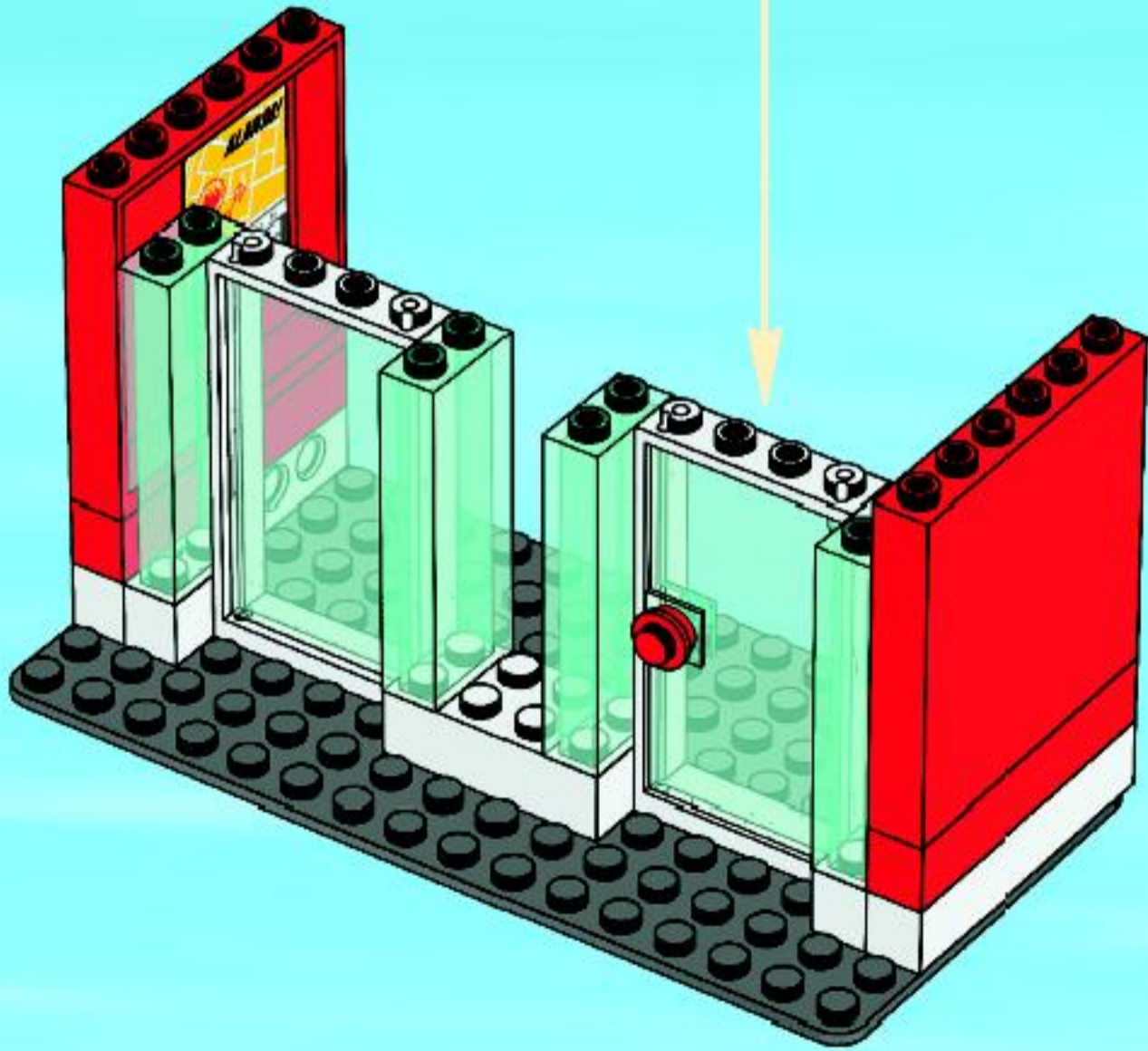



9

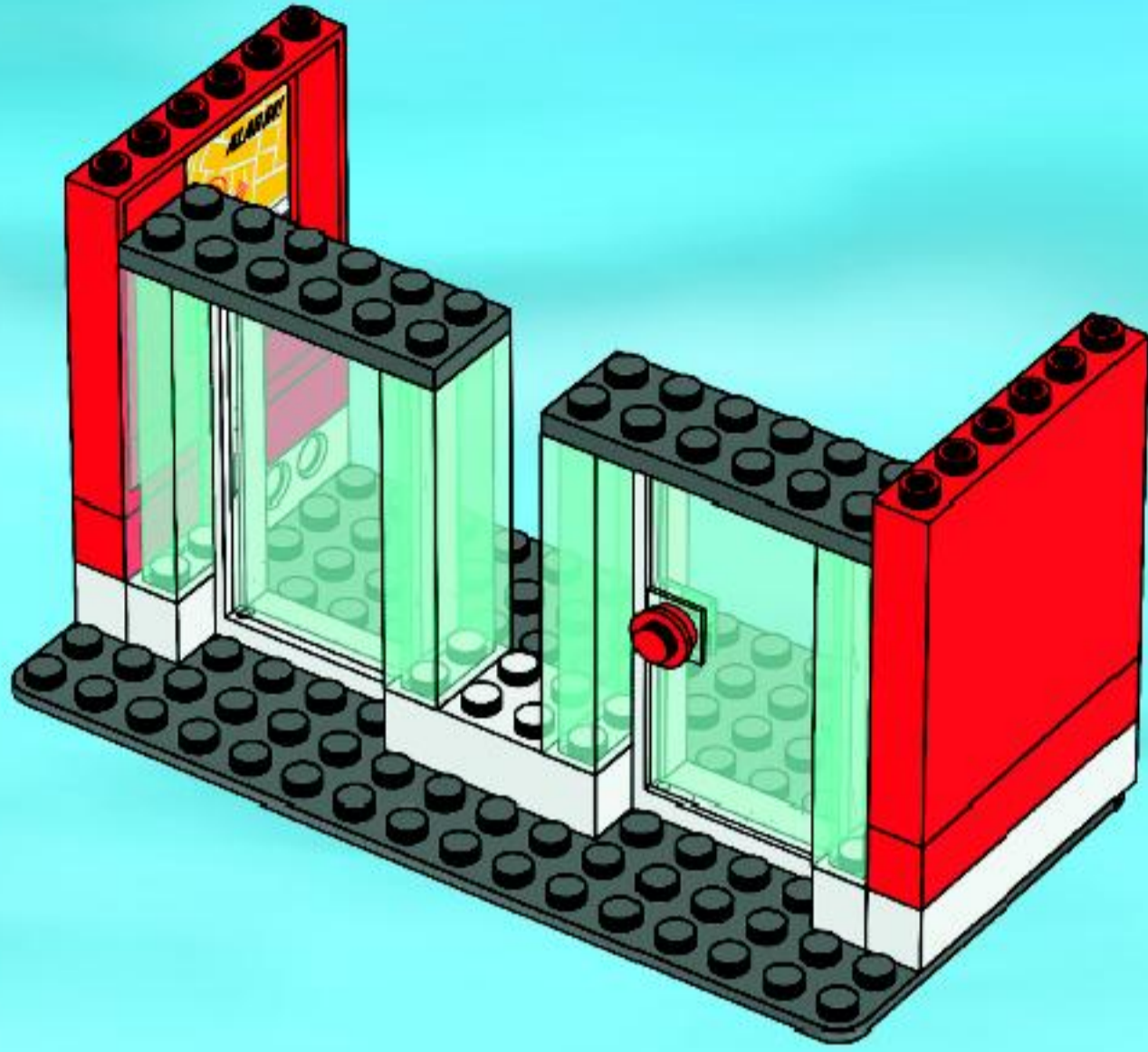

10

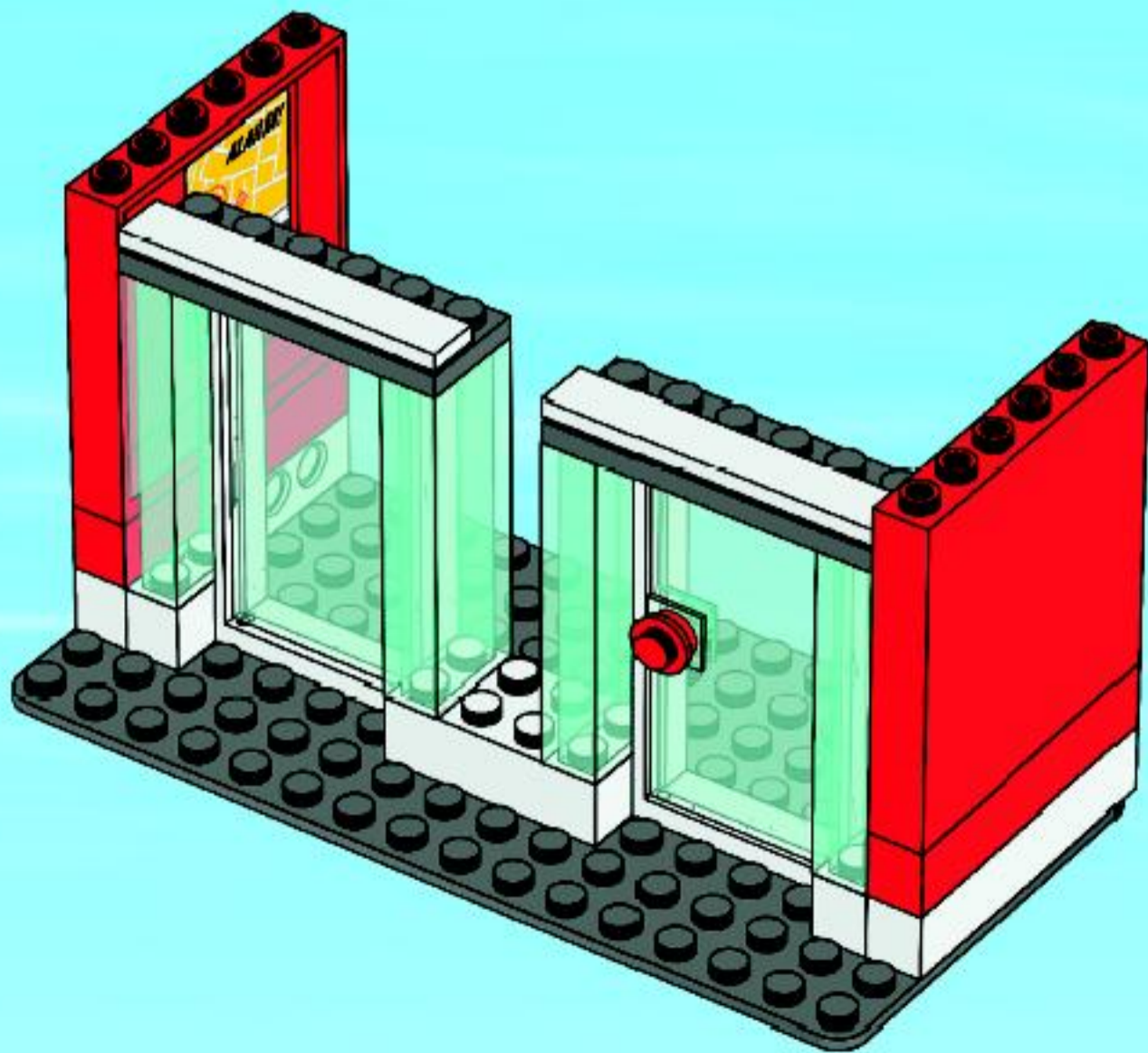



11

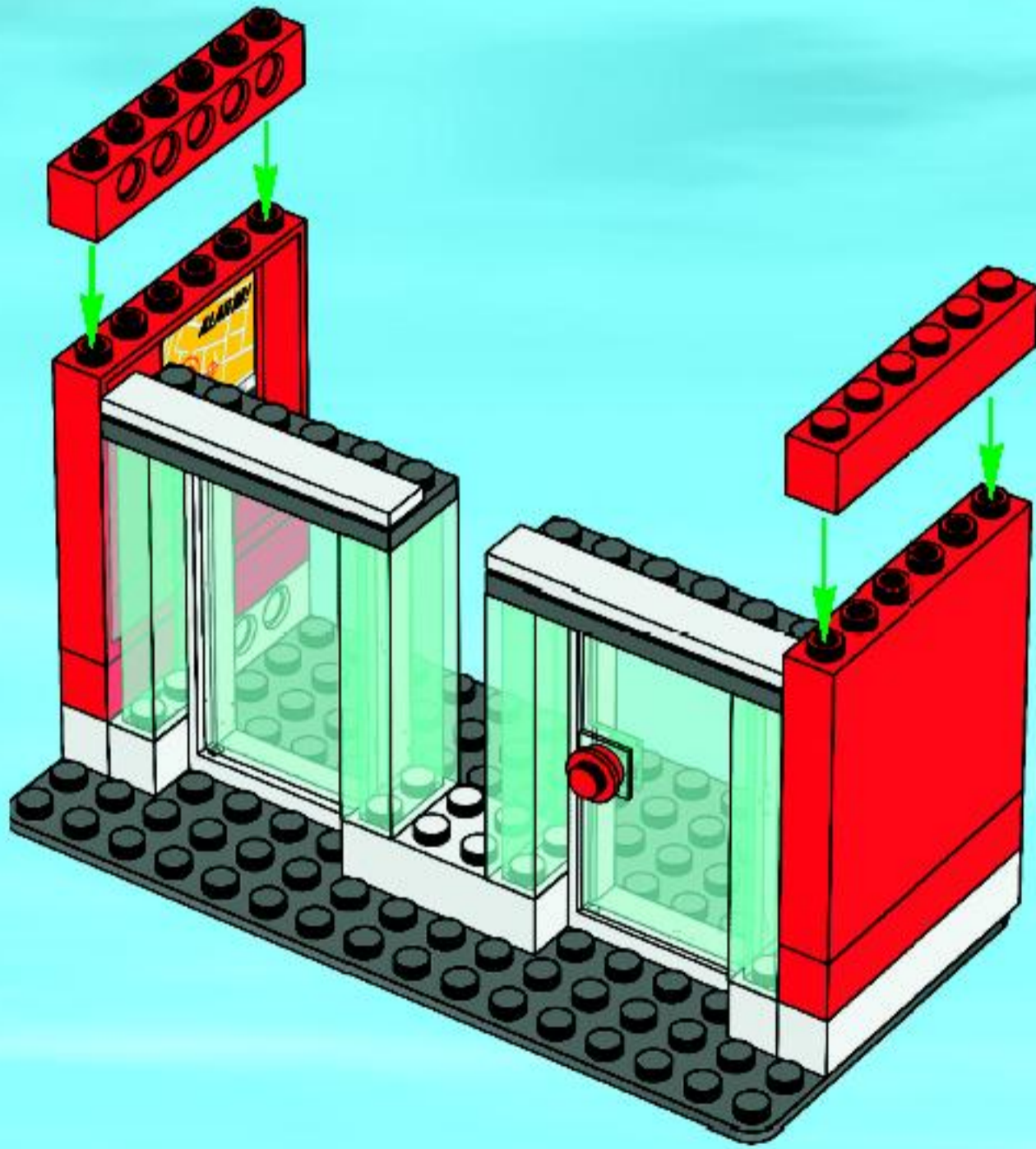



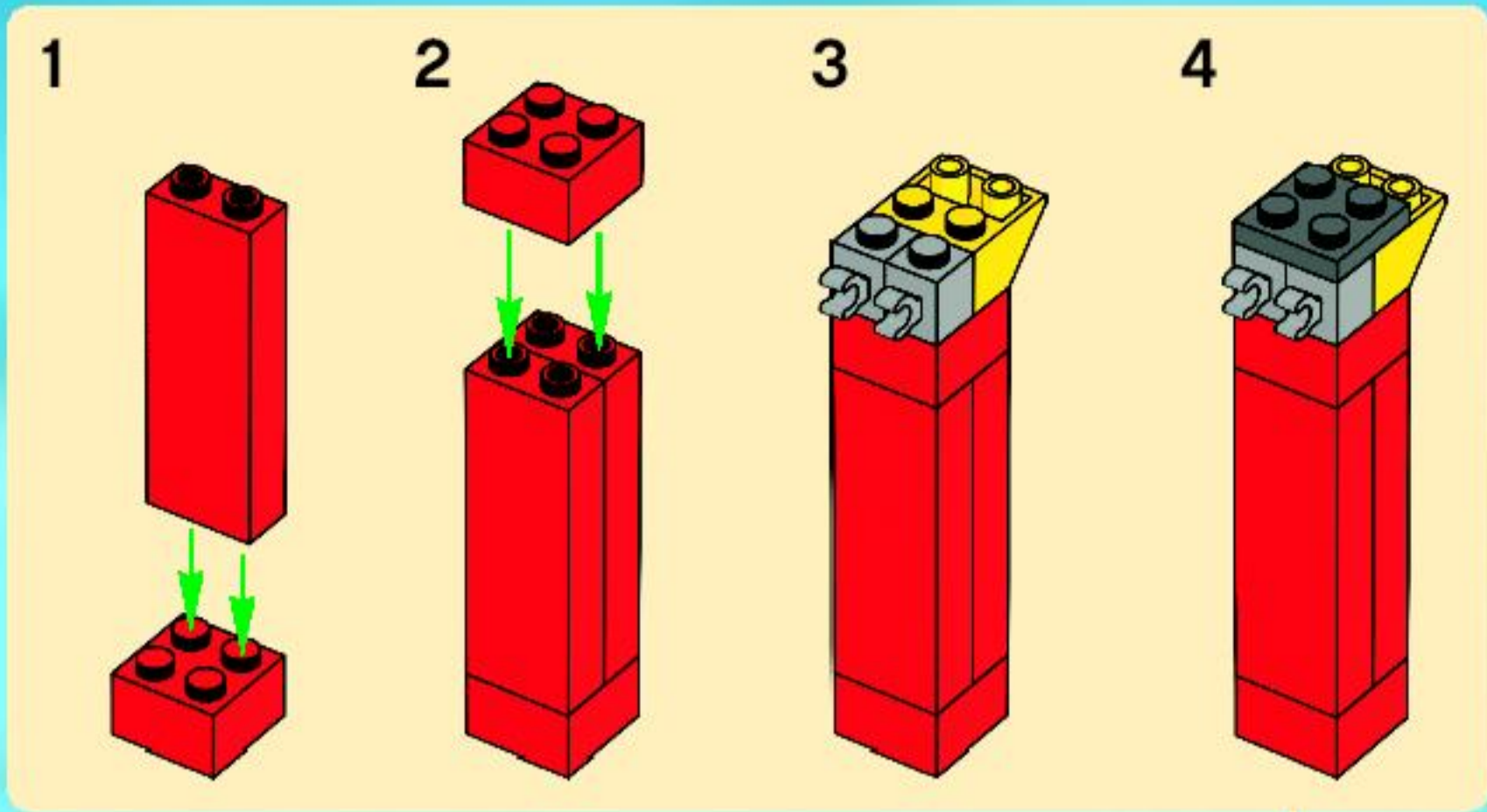

12

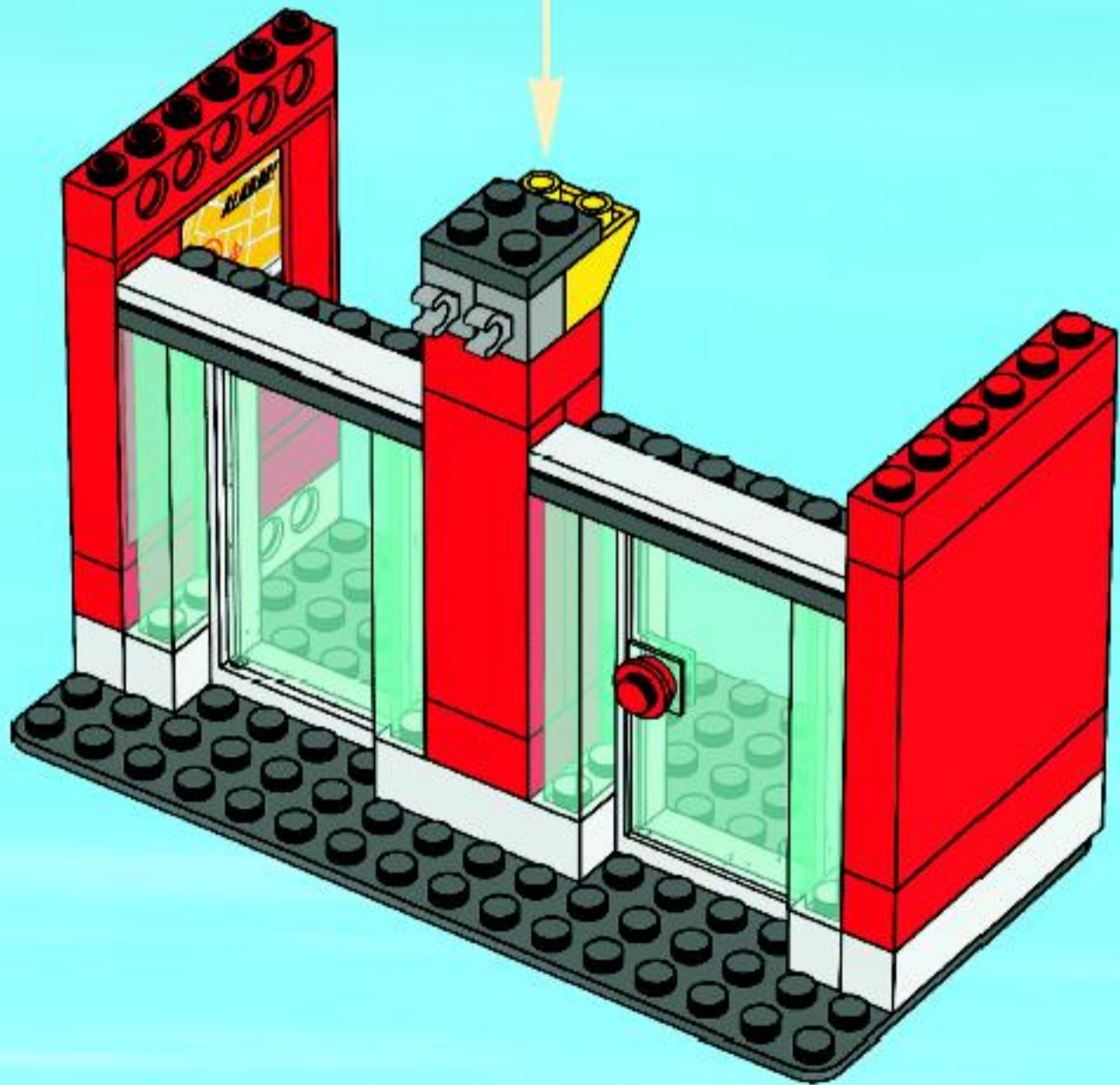



13

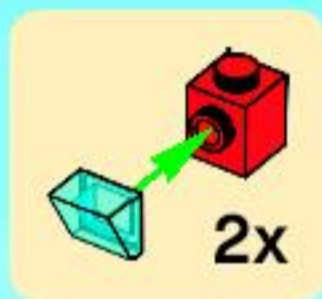
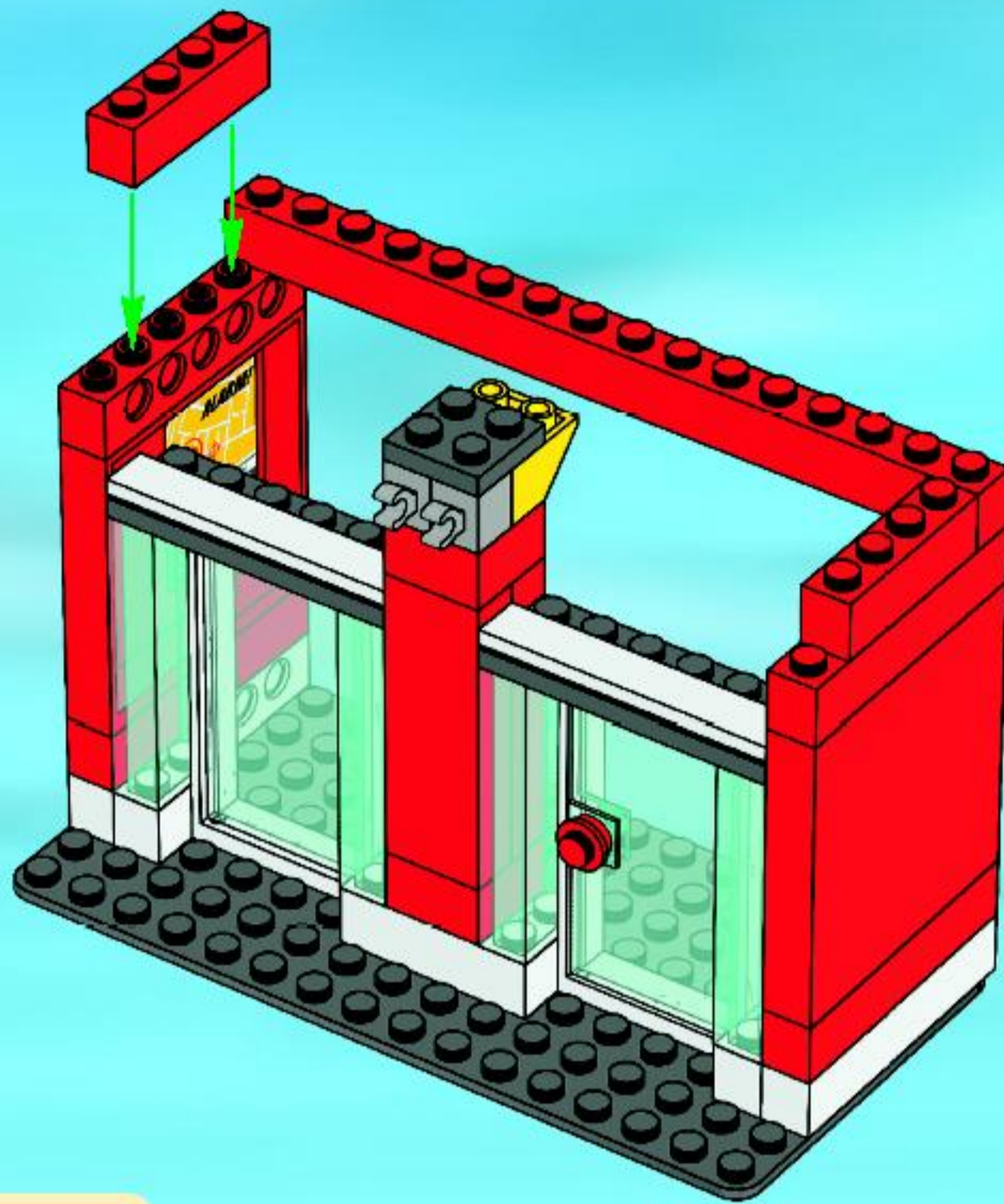

14

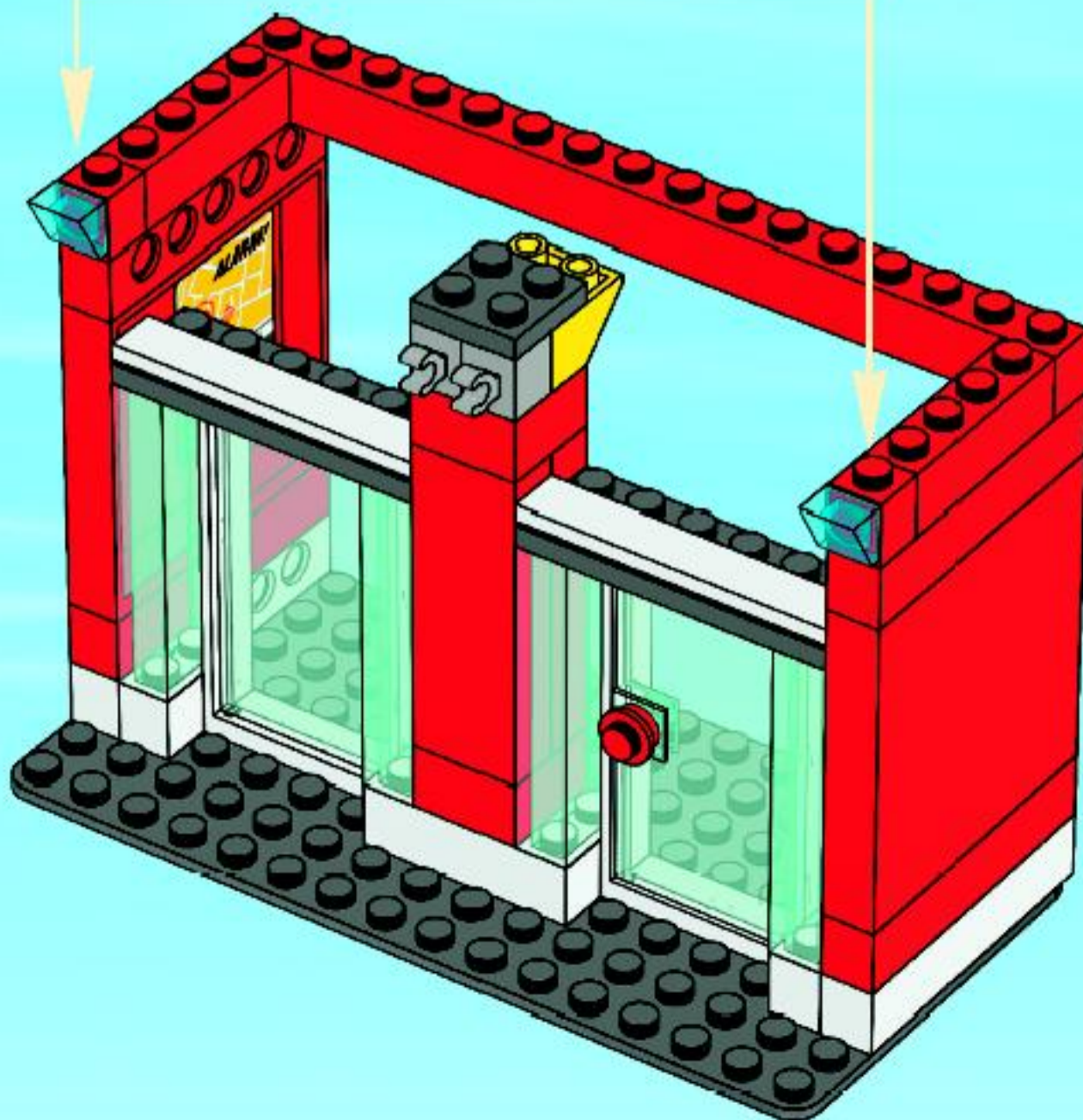



15

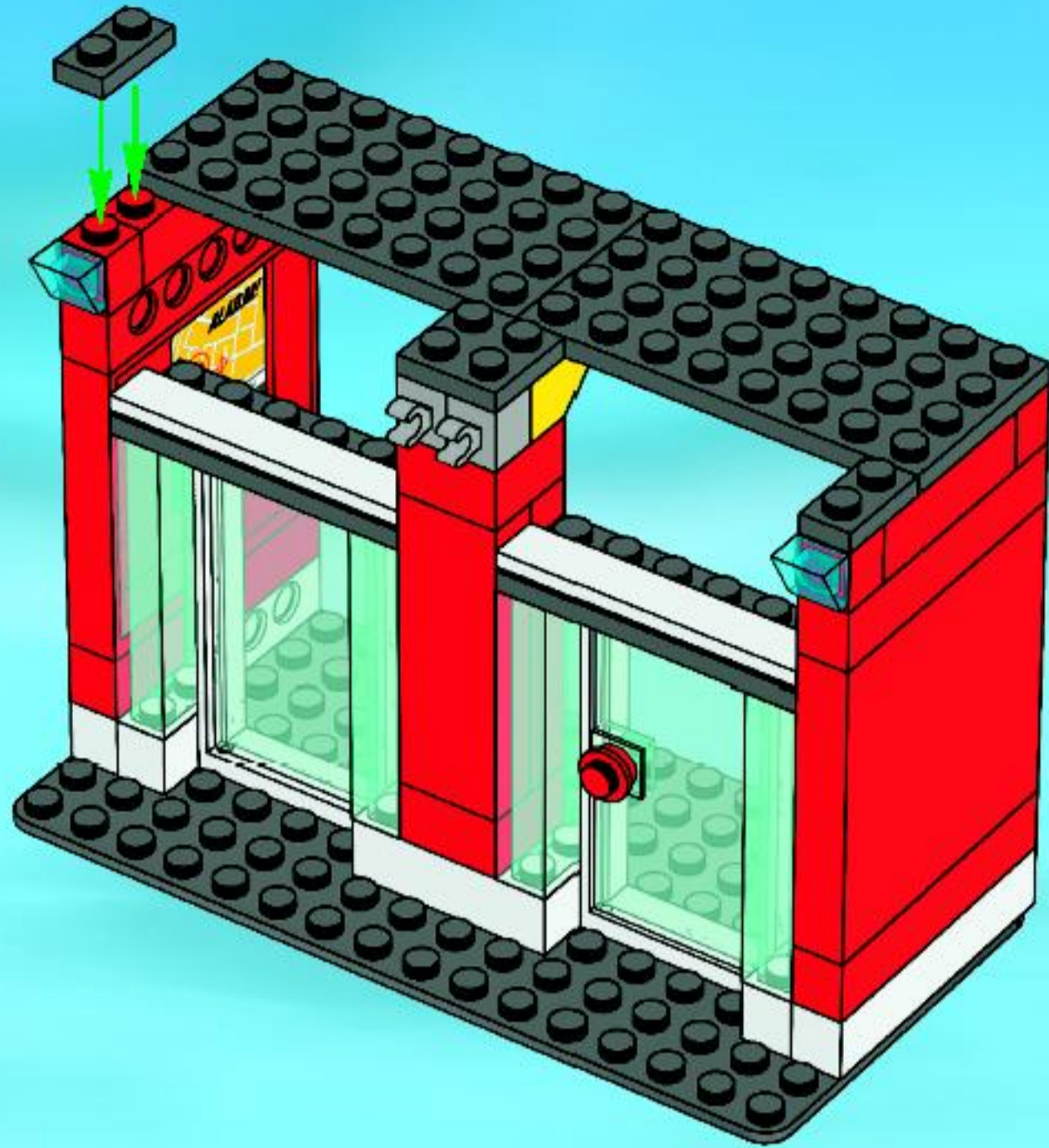

16

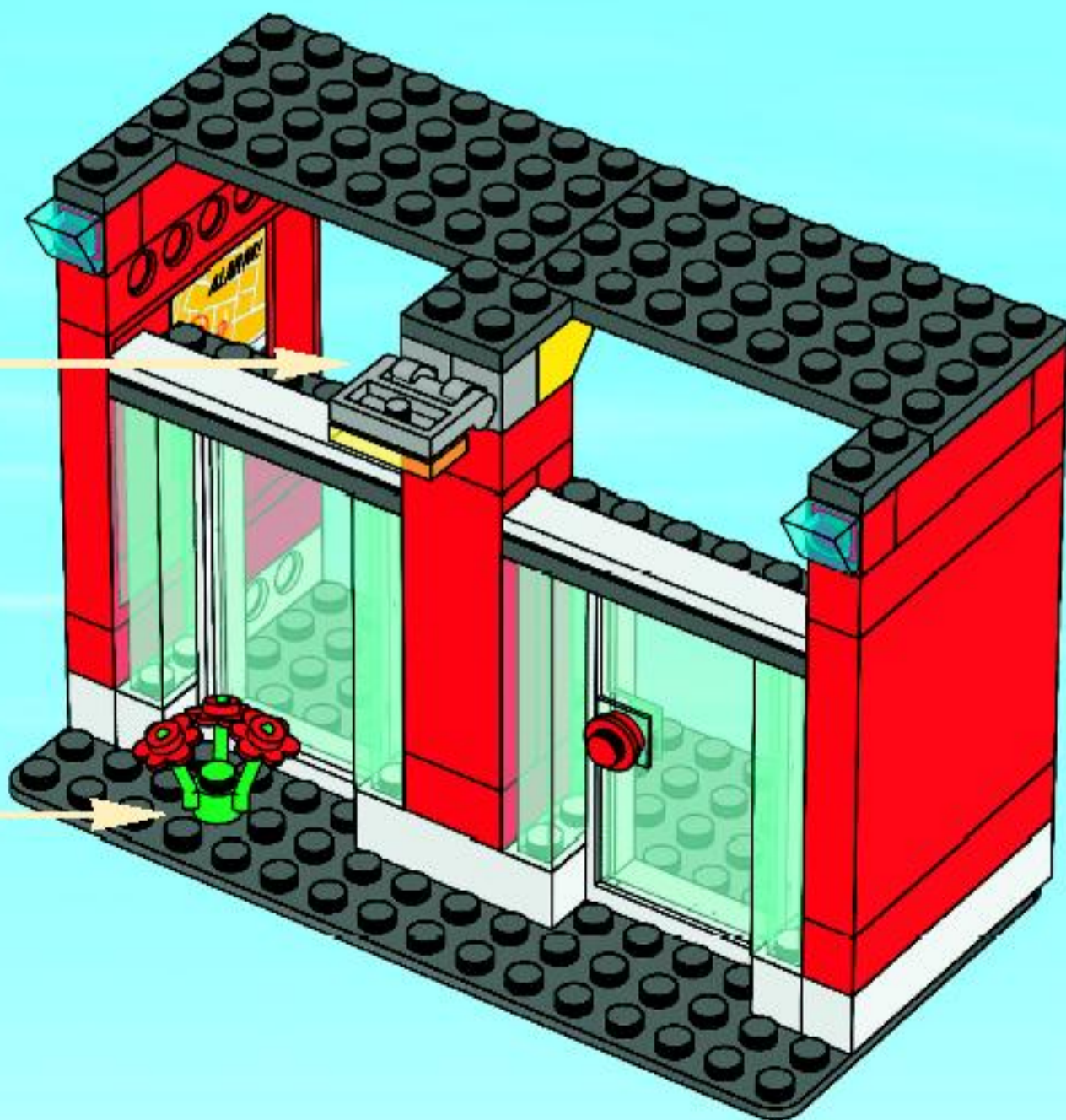
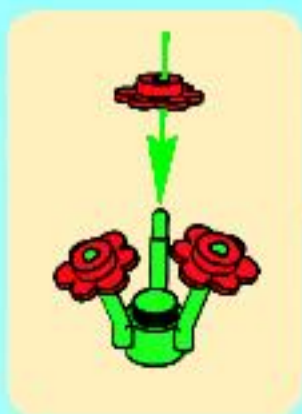
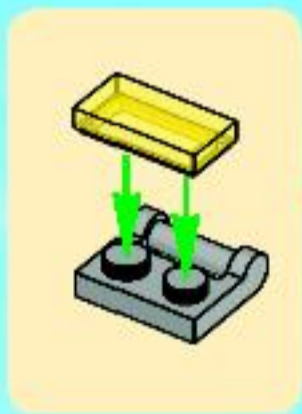



17

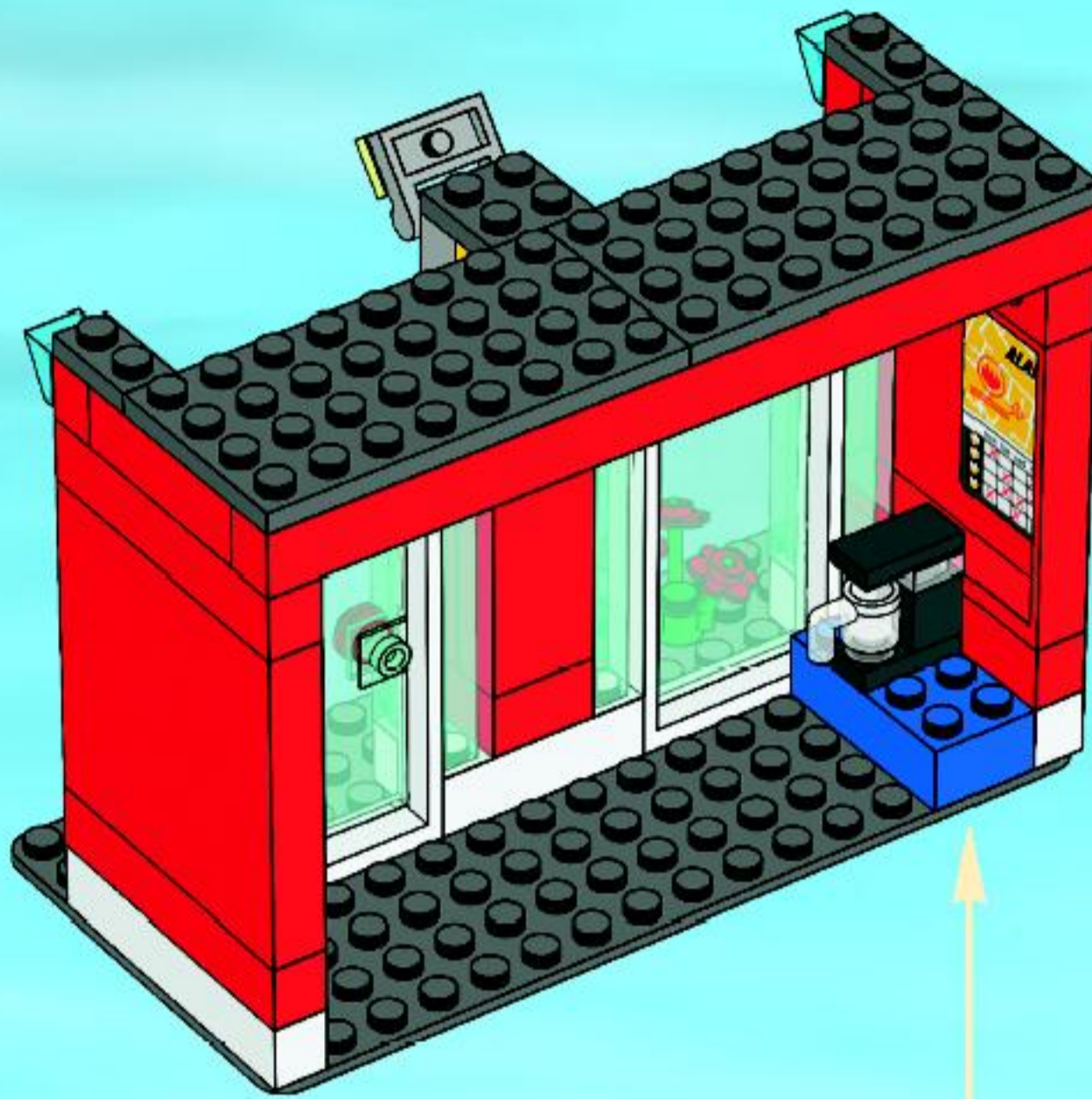

1

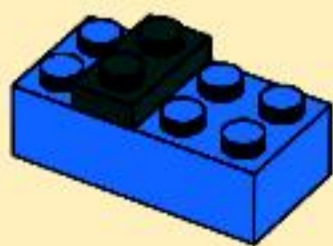

2



3





# 18

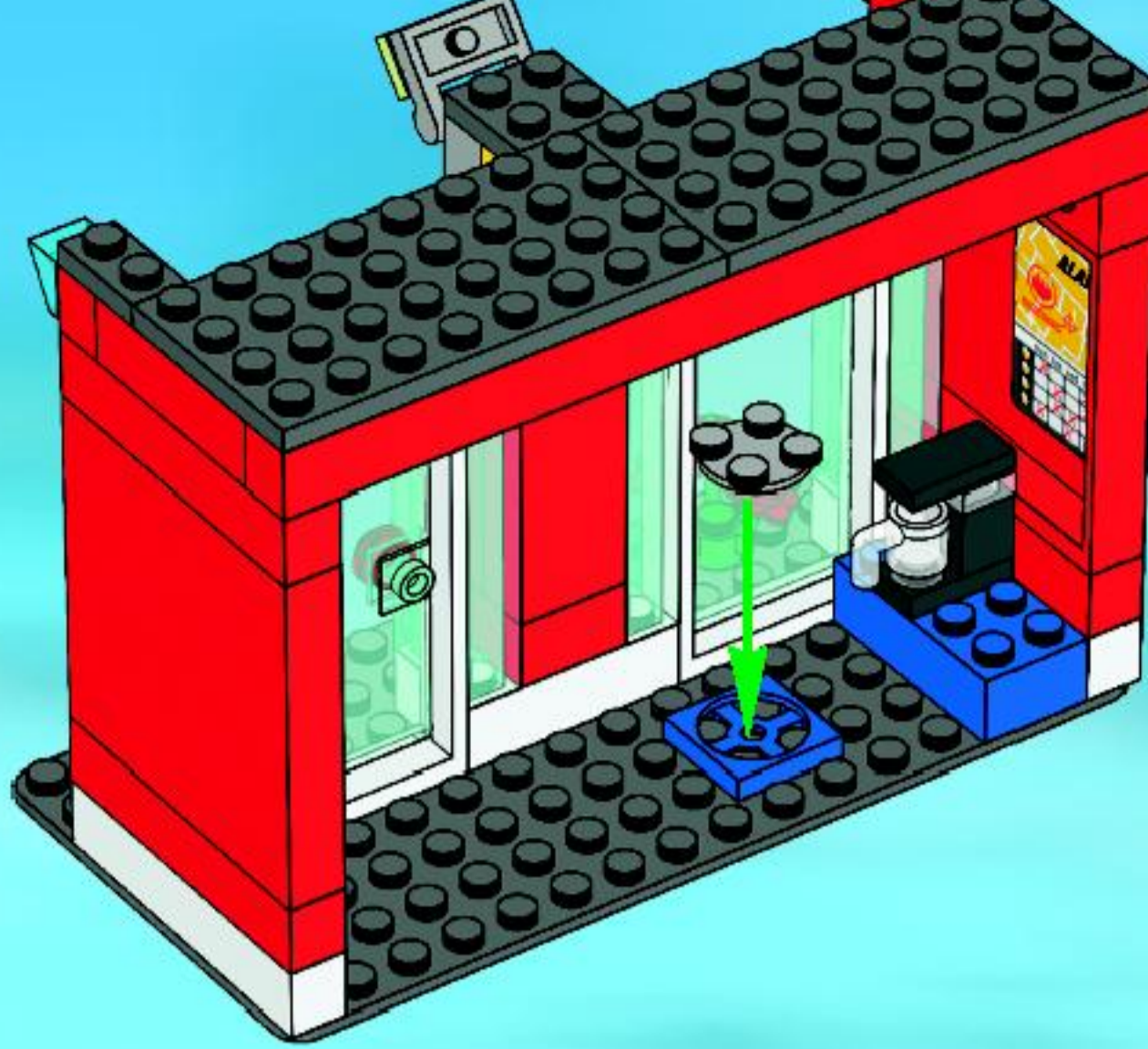

1

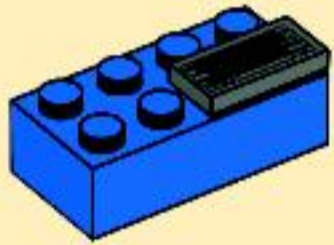

2

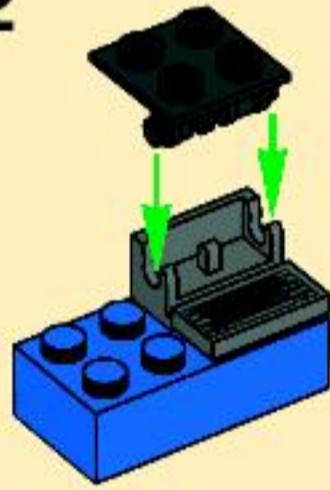

3



4

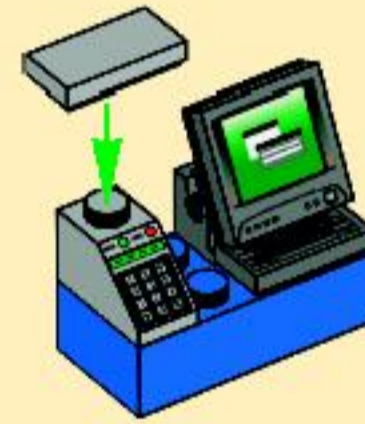

# 19

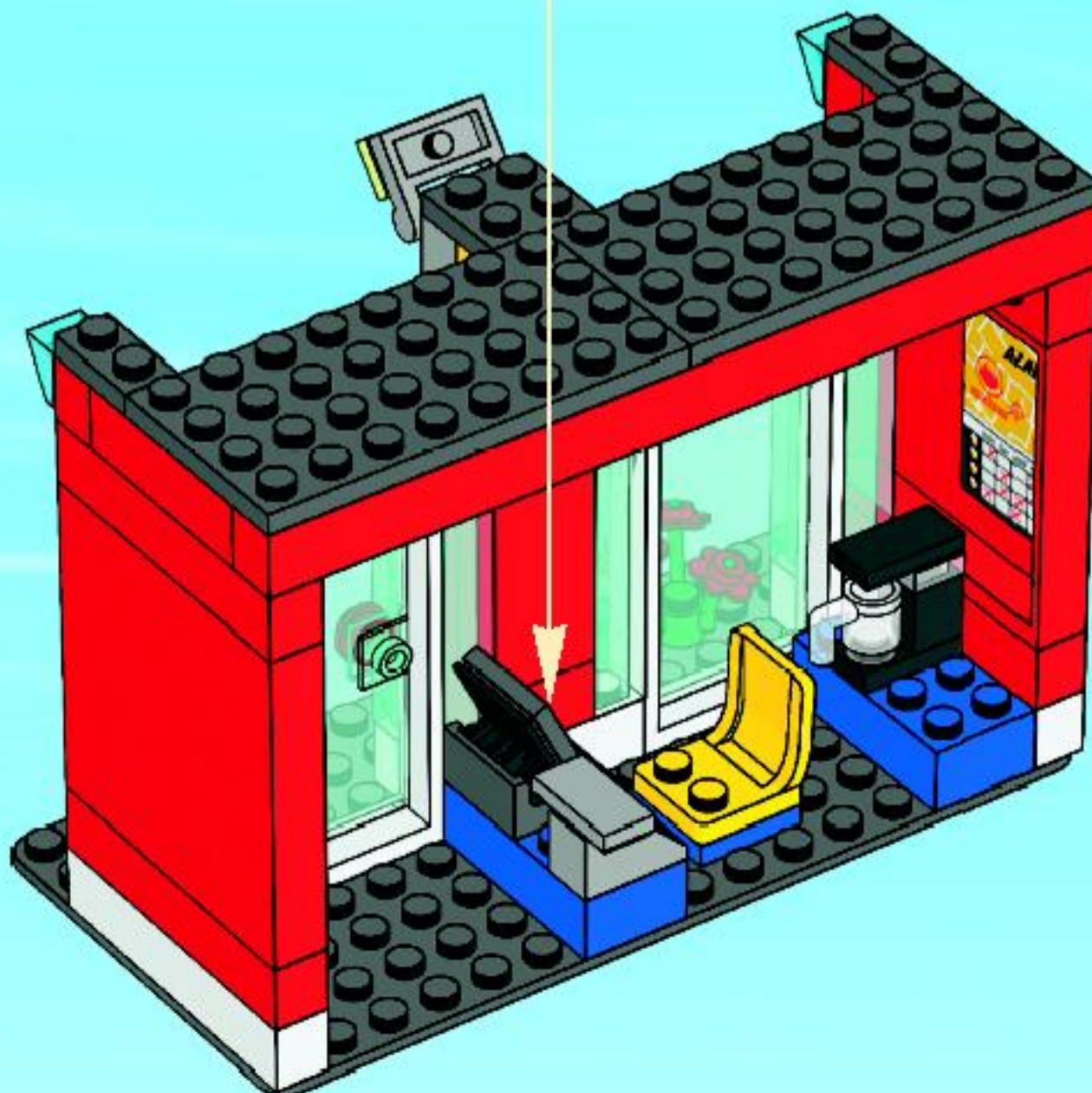



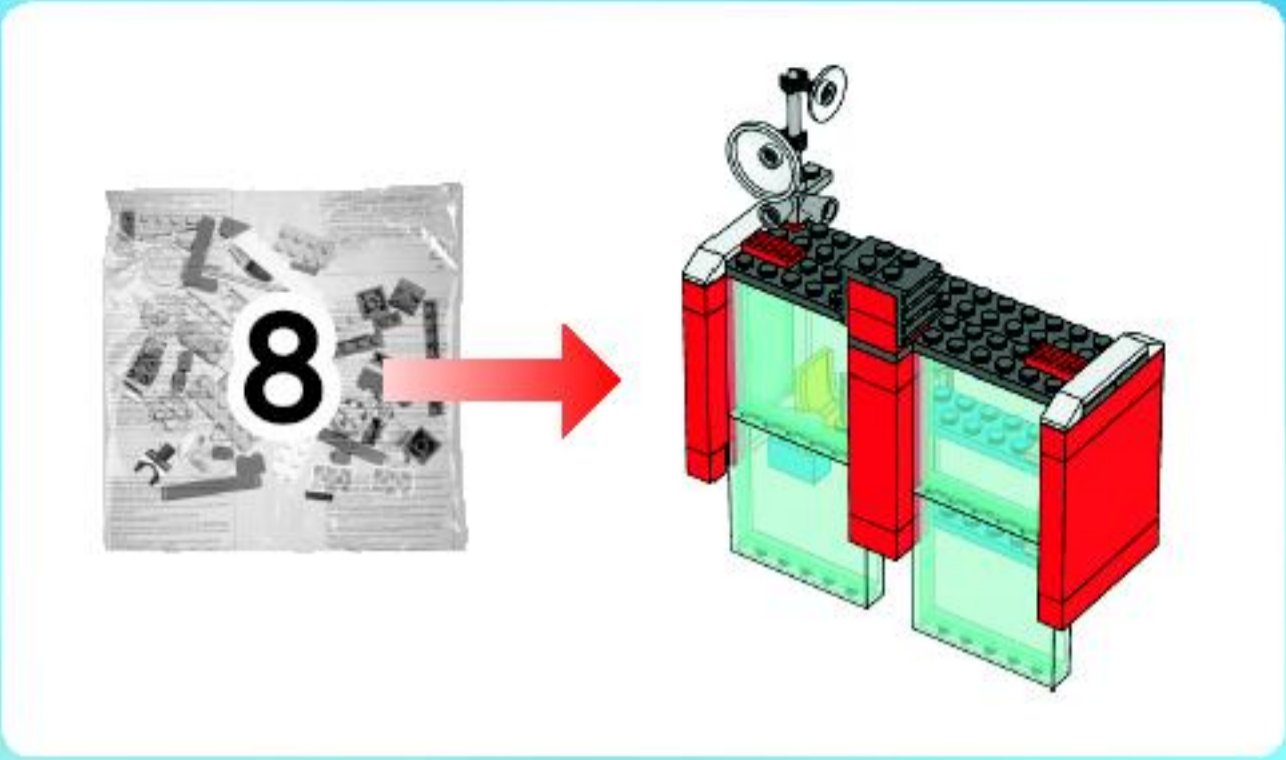

20

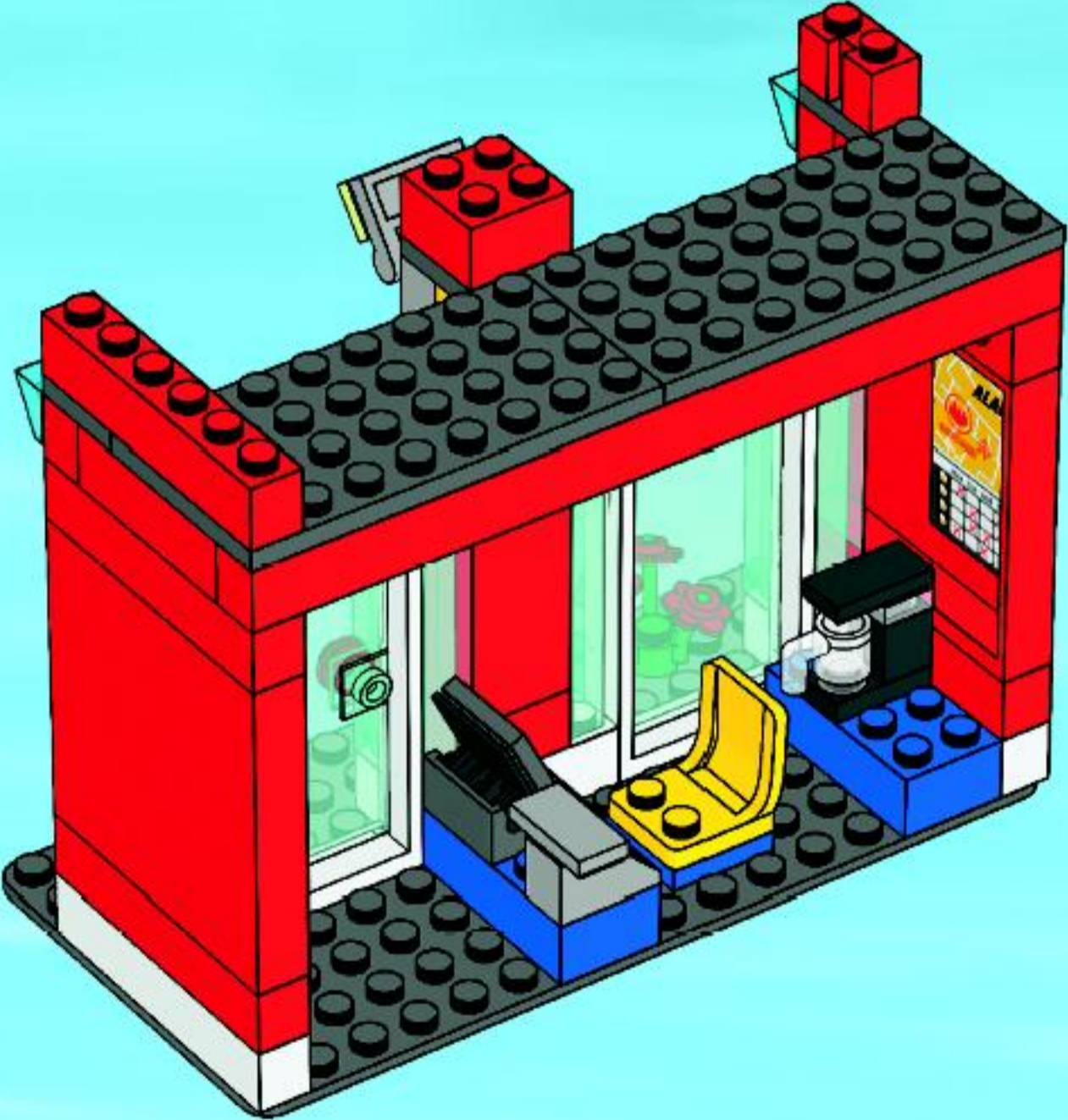



21

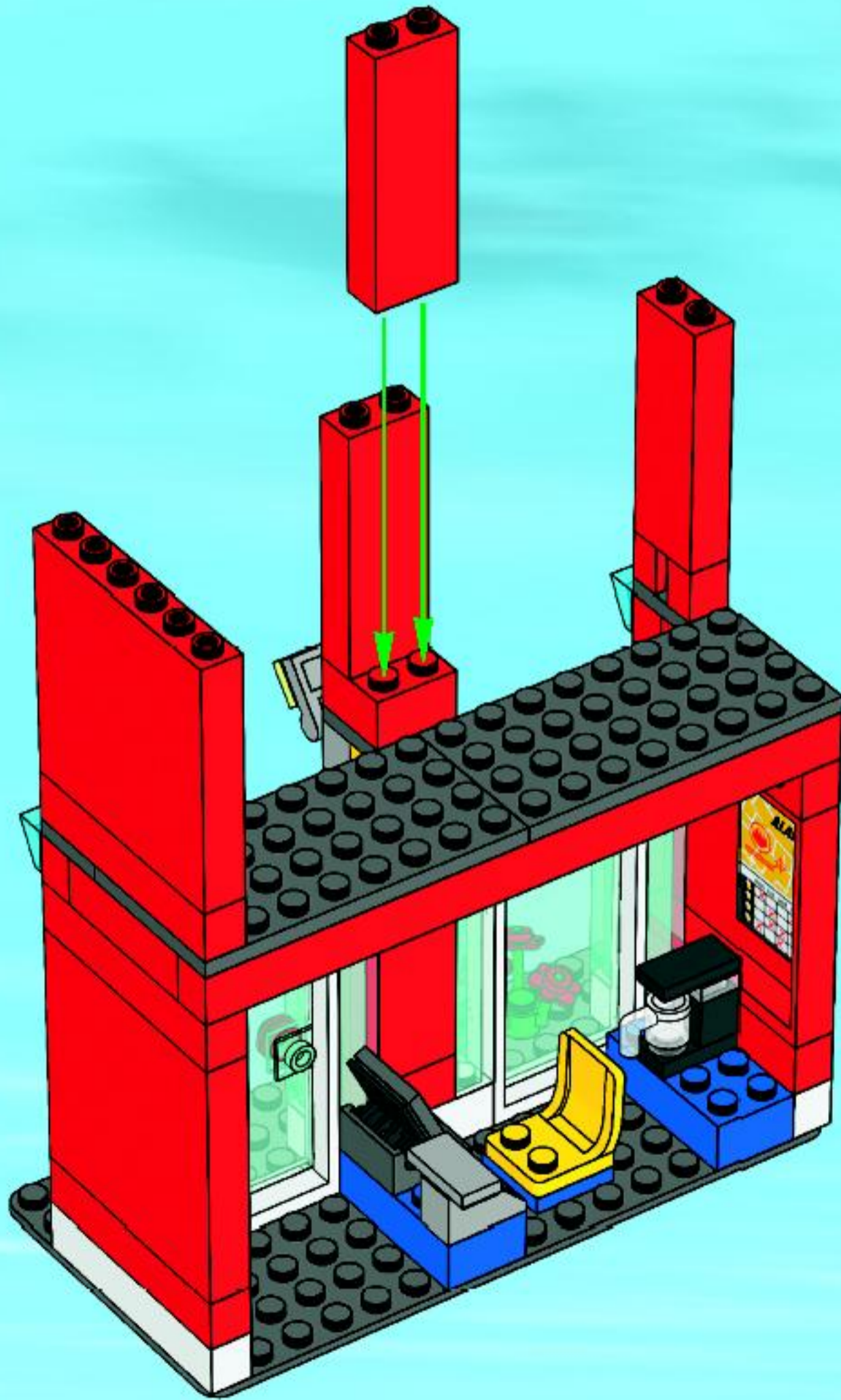



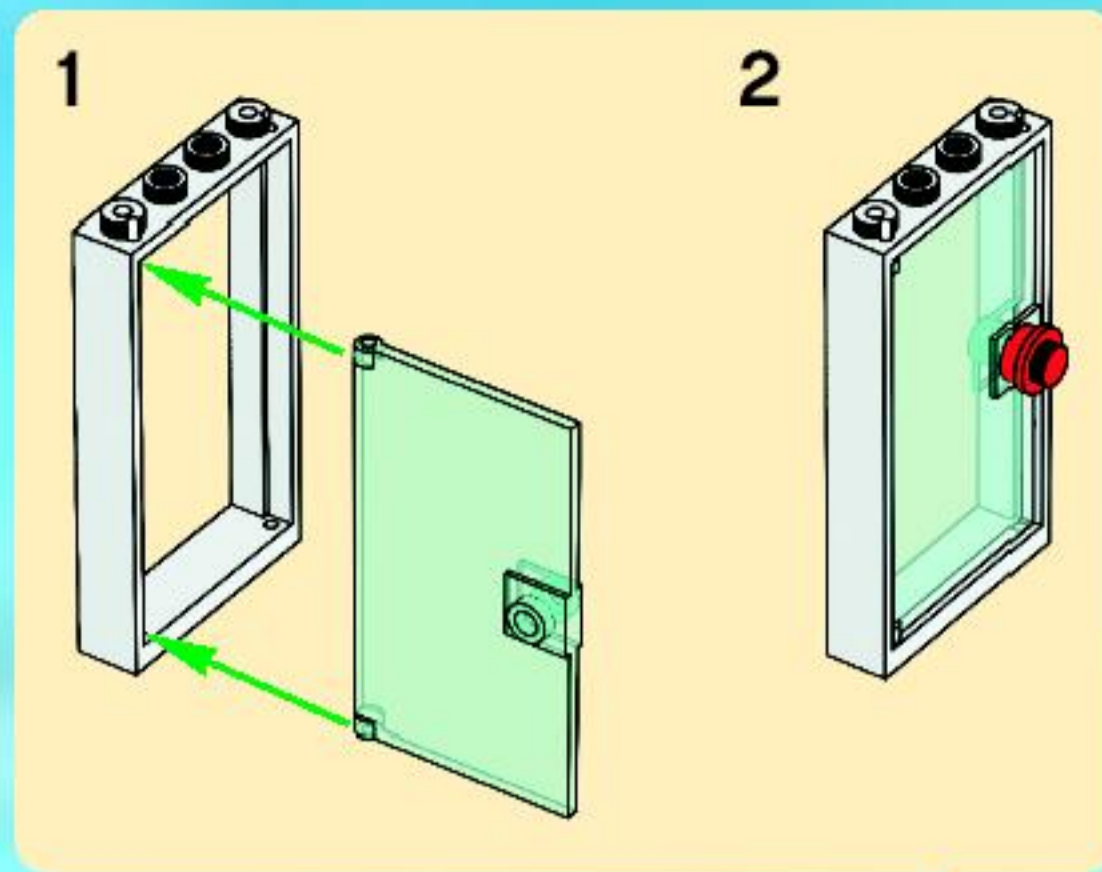

22

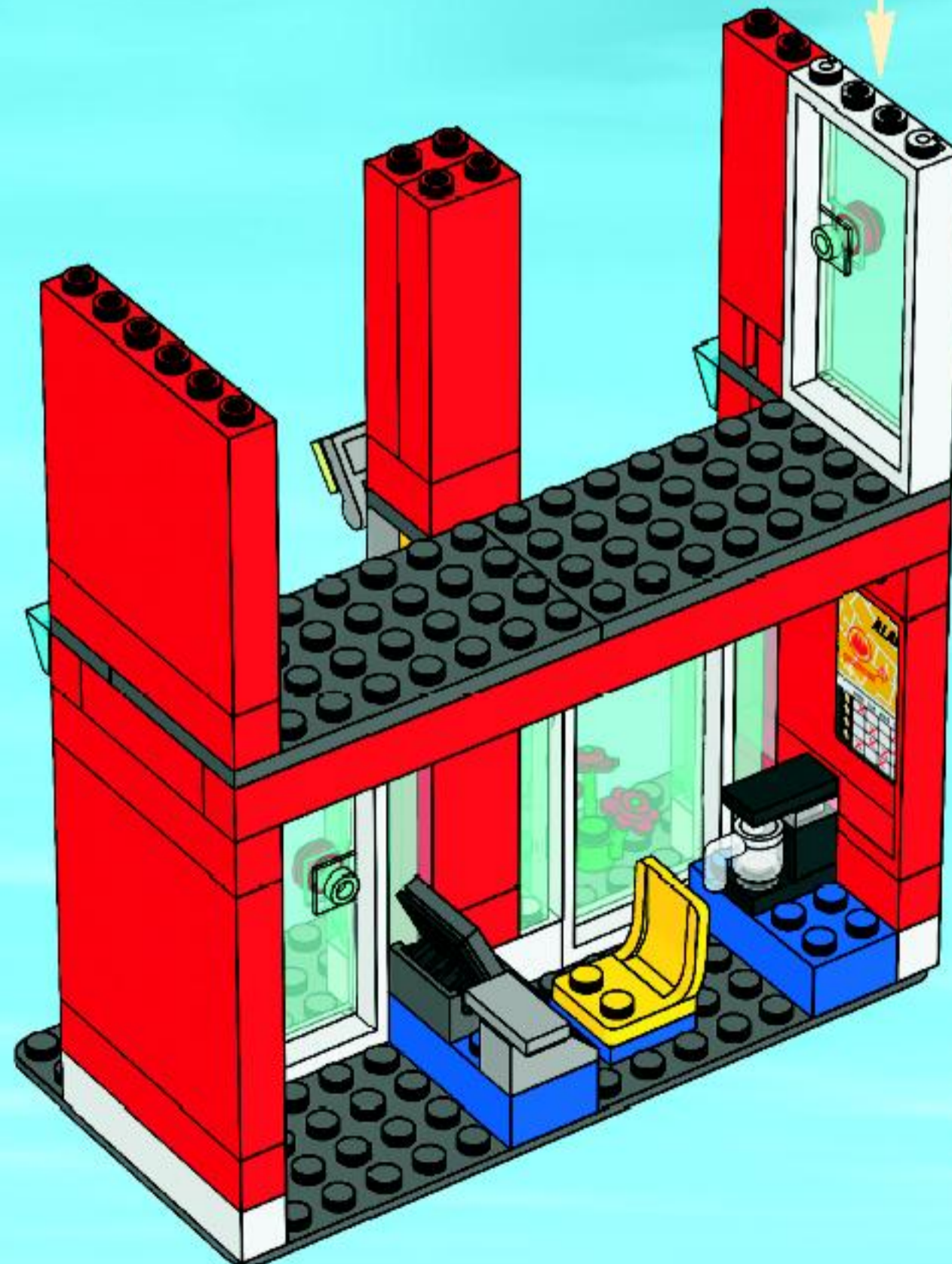



23

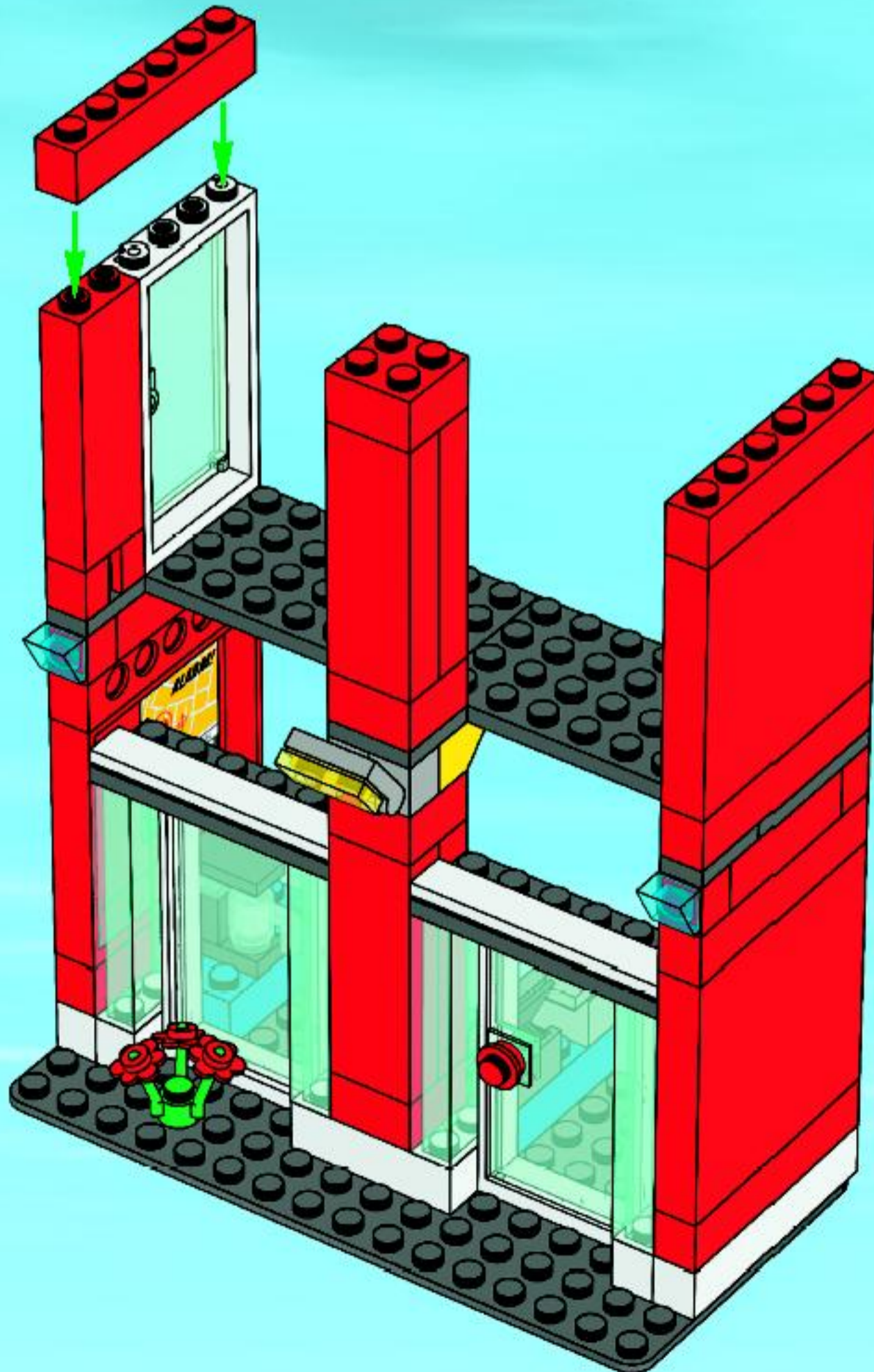



24

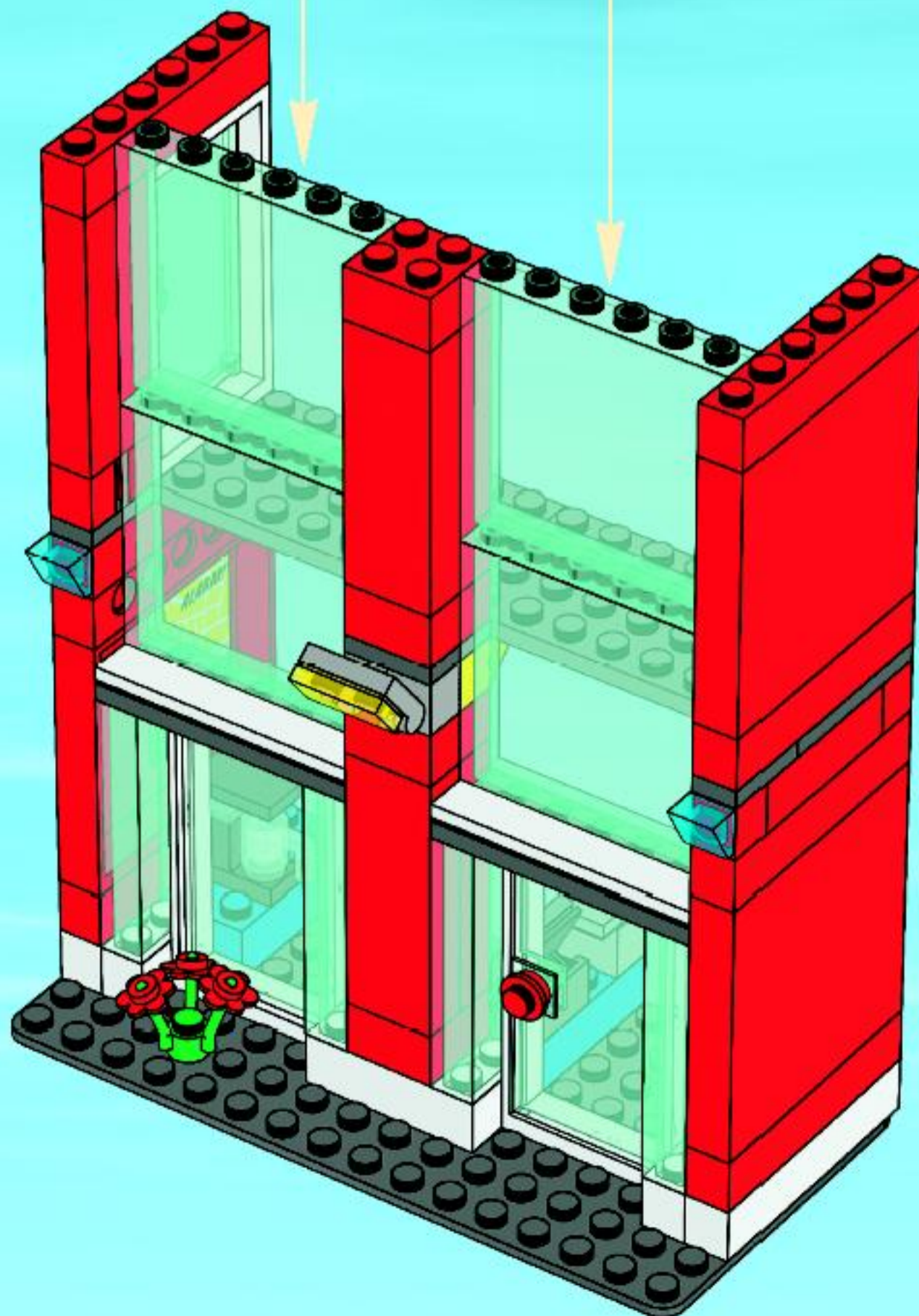
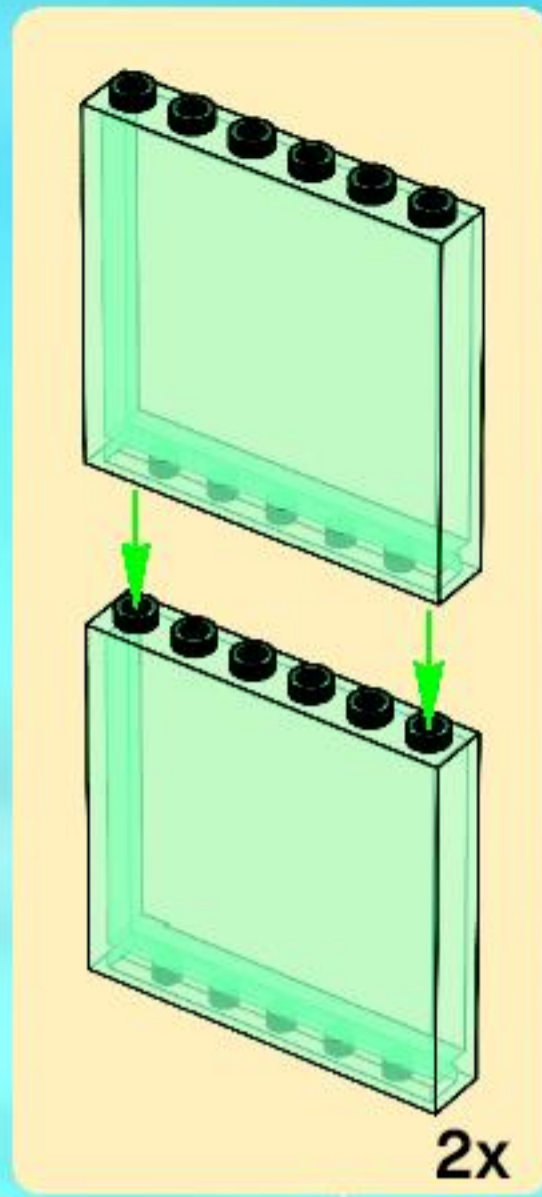



25

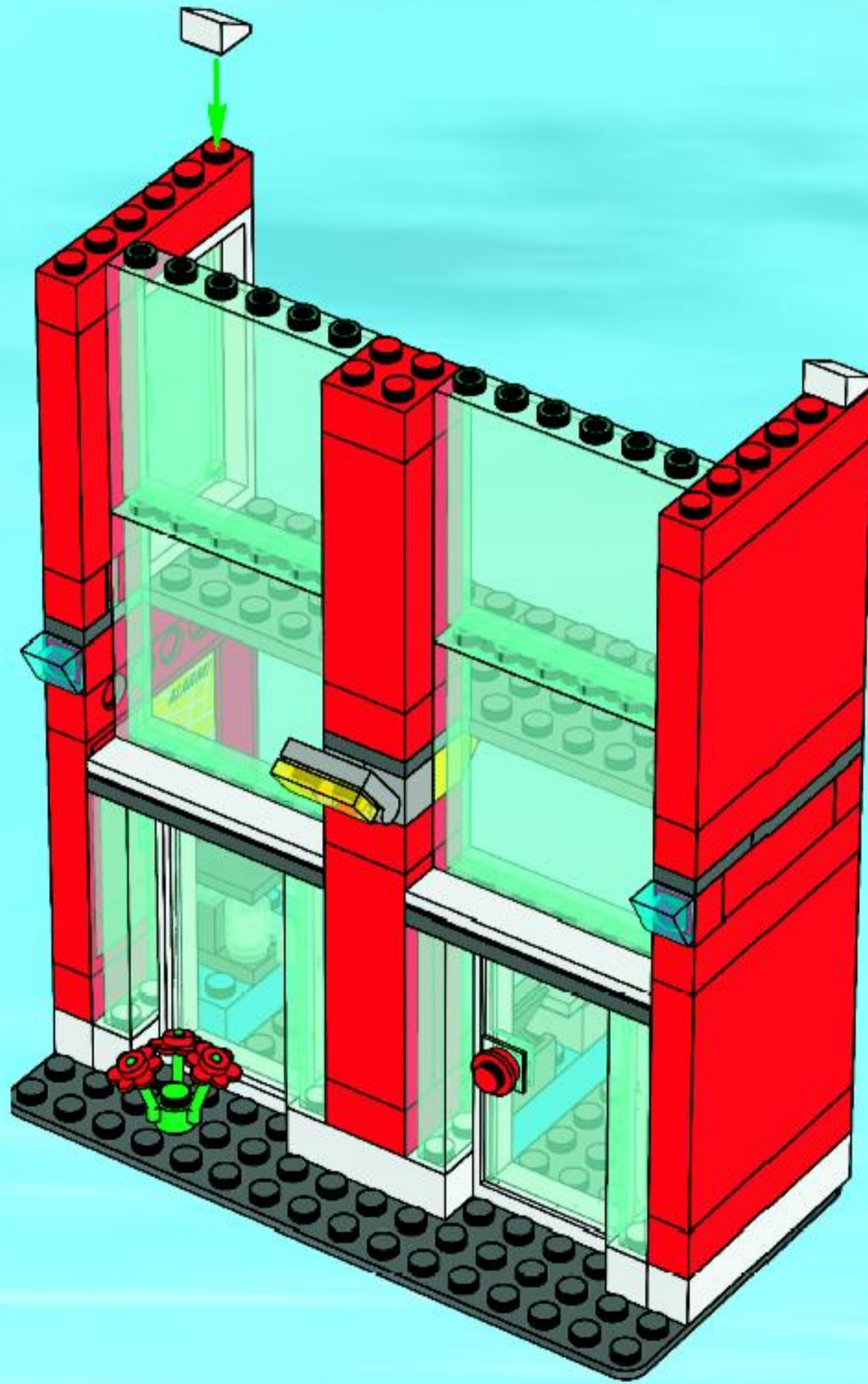



26

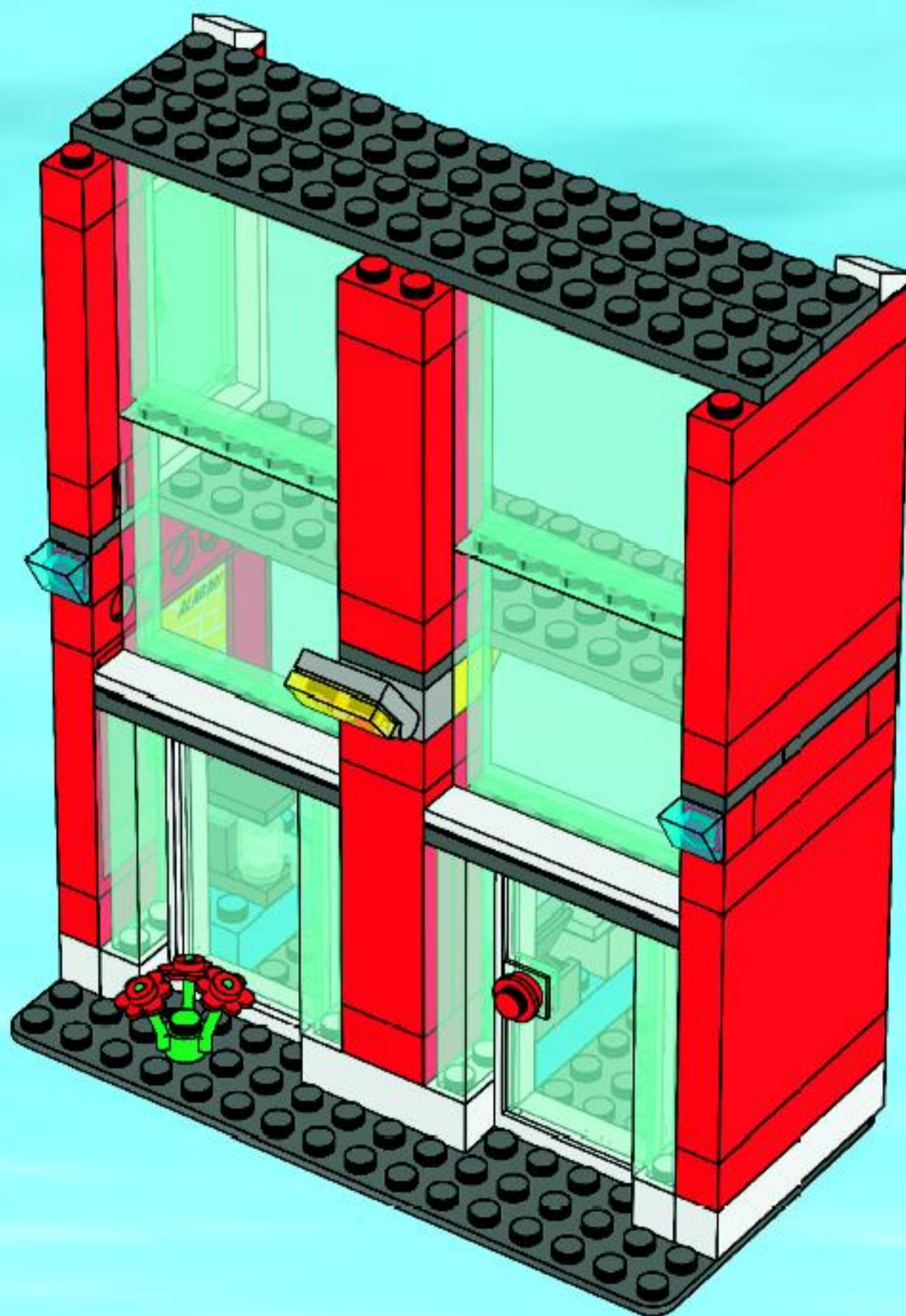



27





28

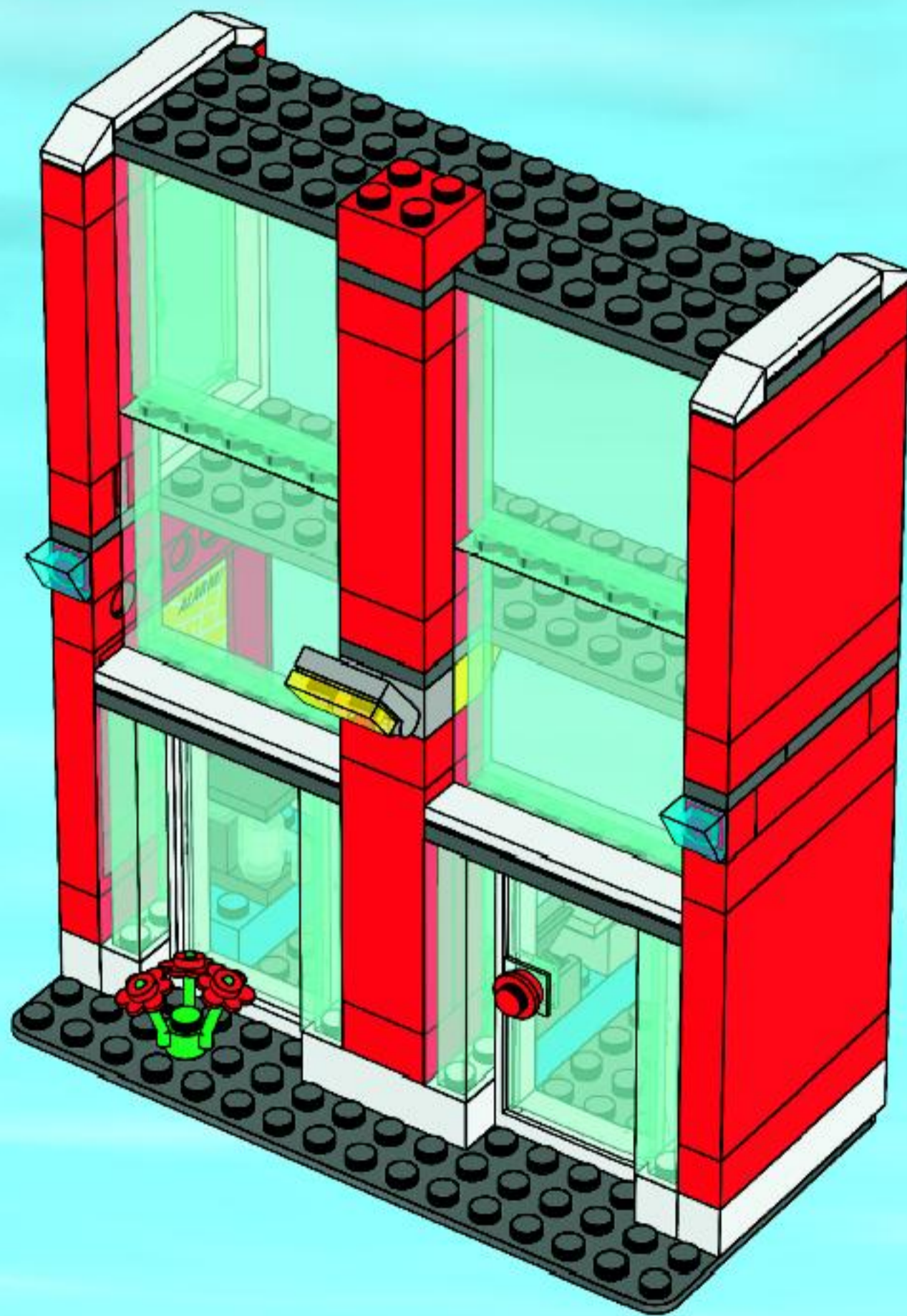



29

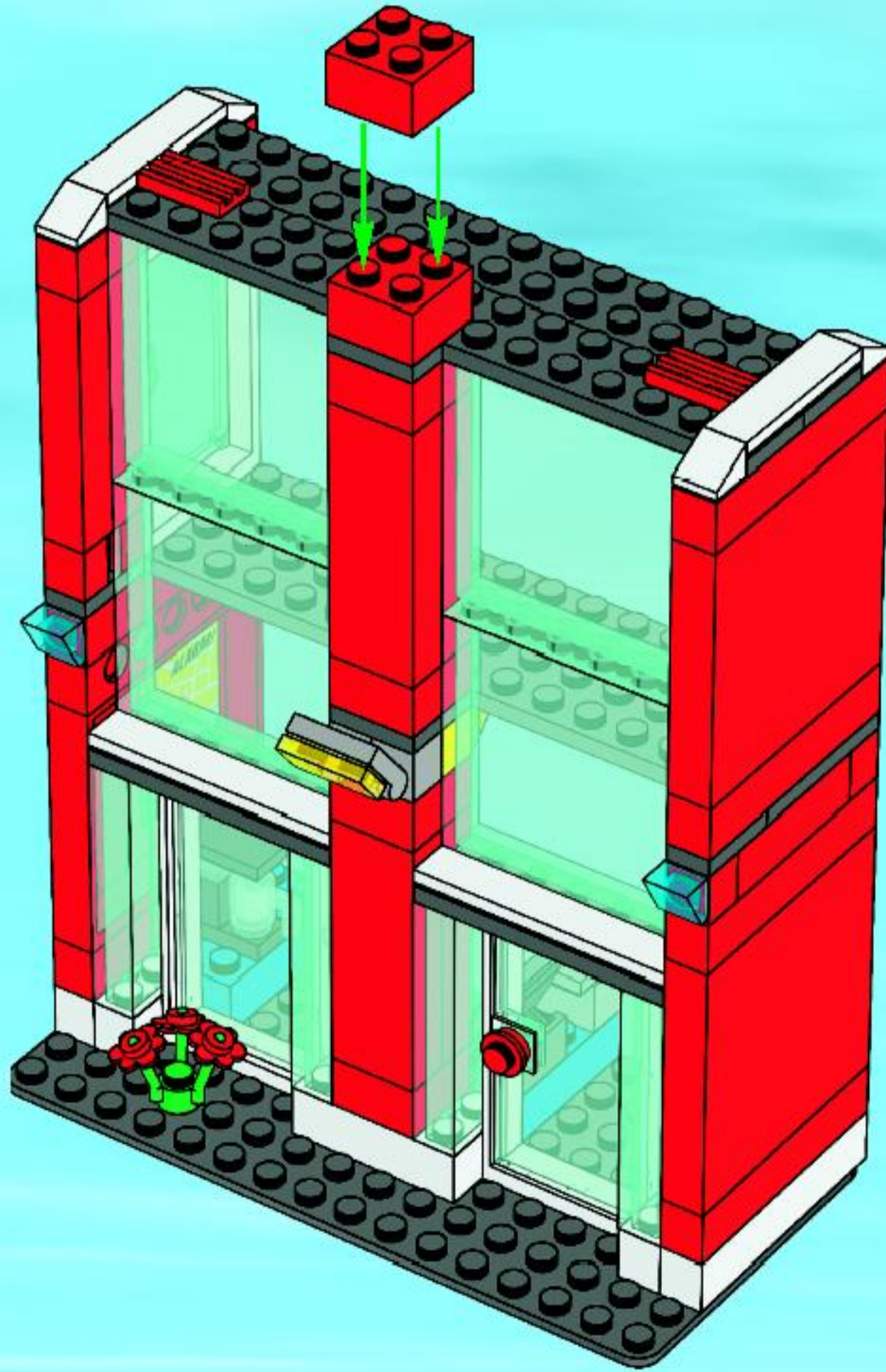



30

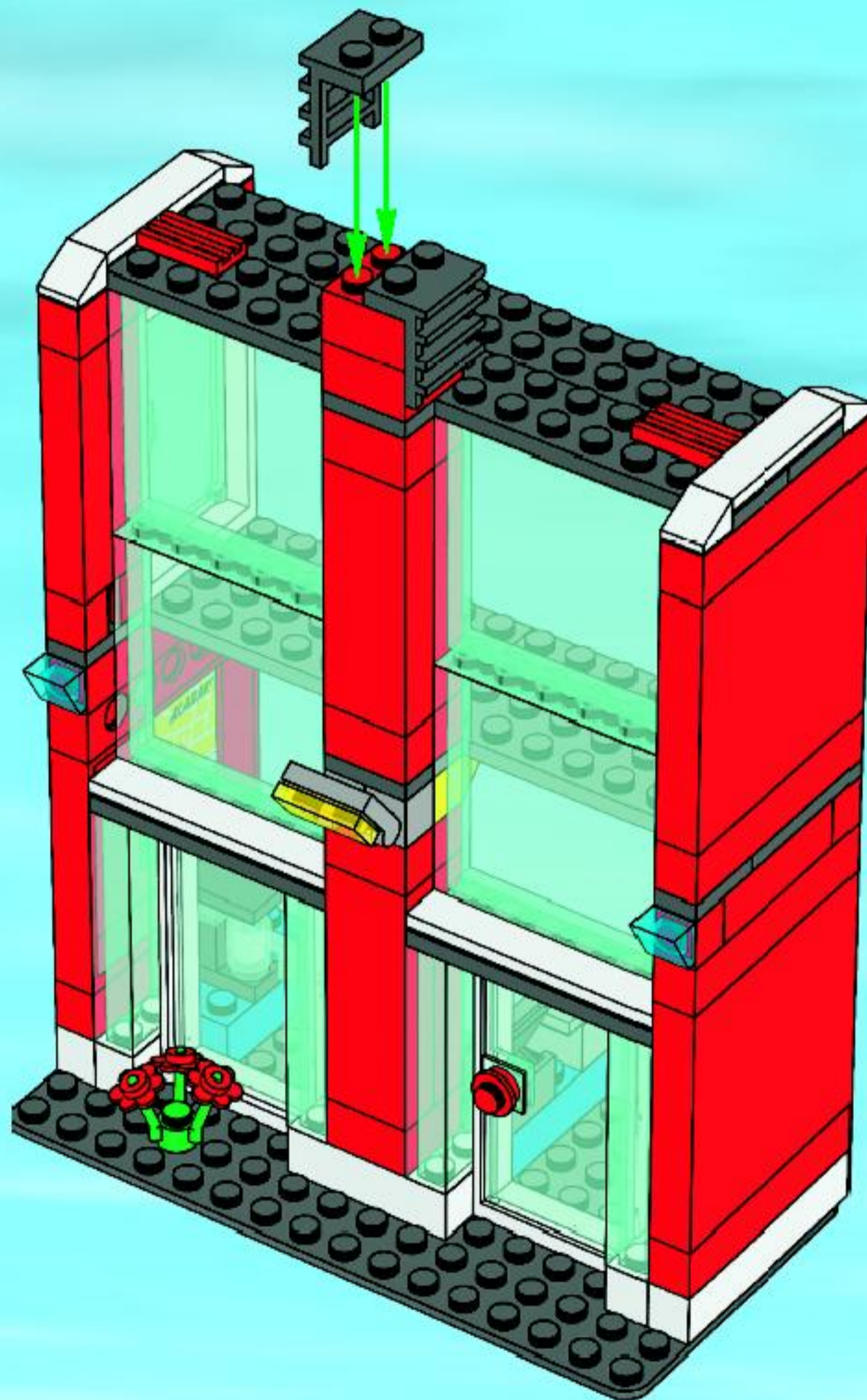



31

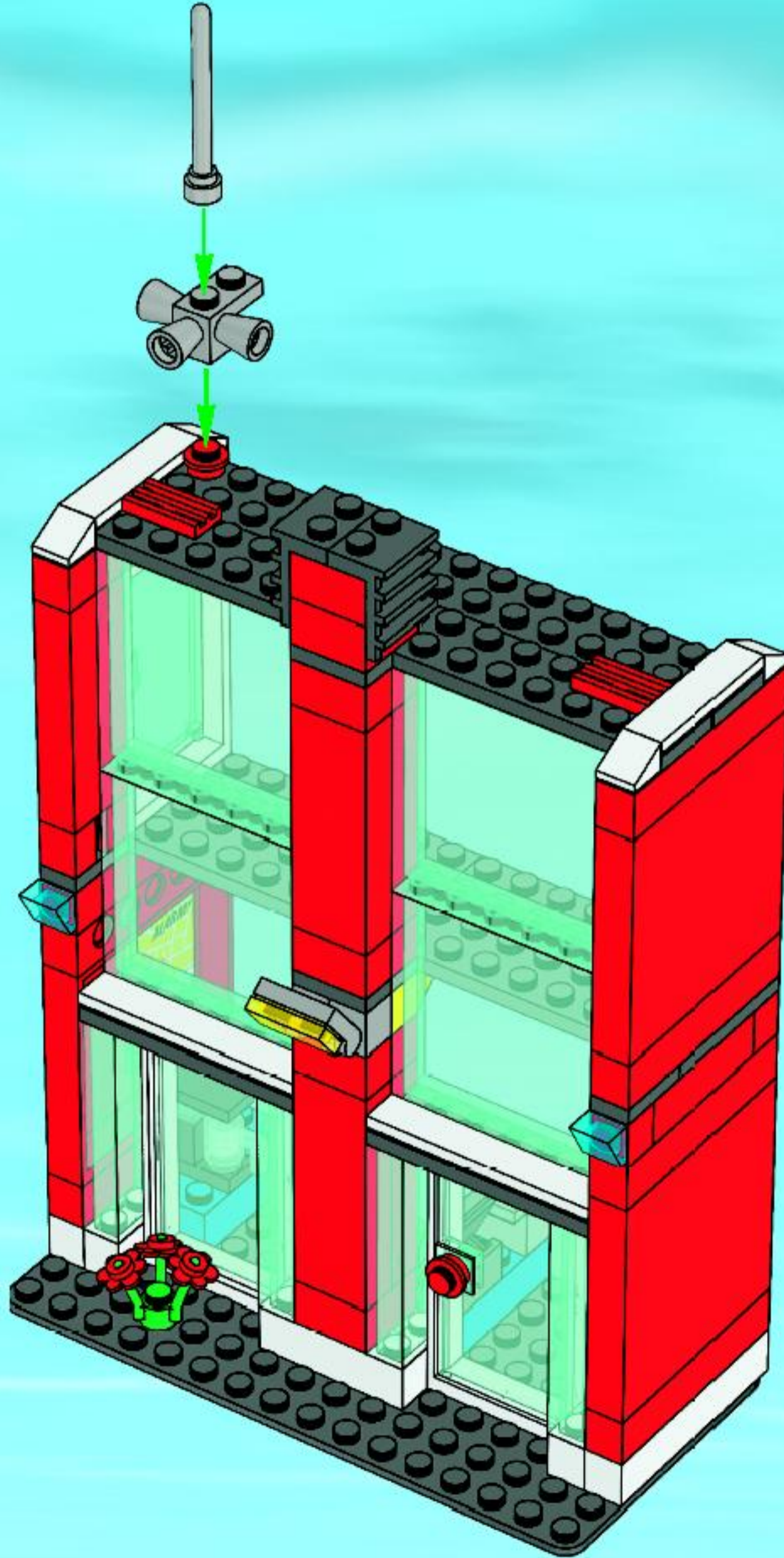



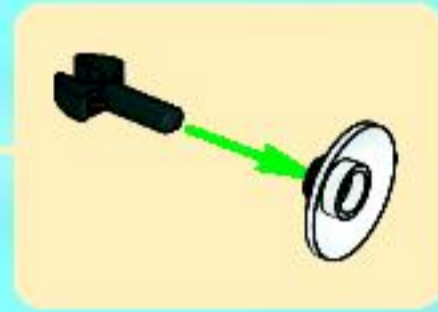
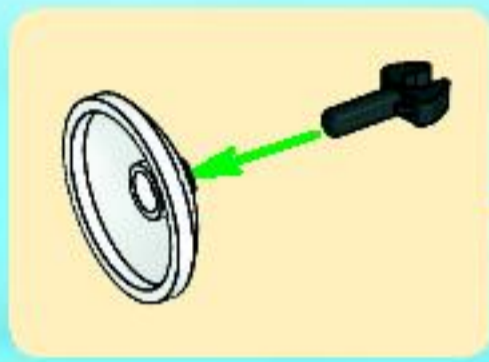

32

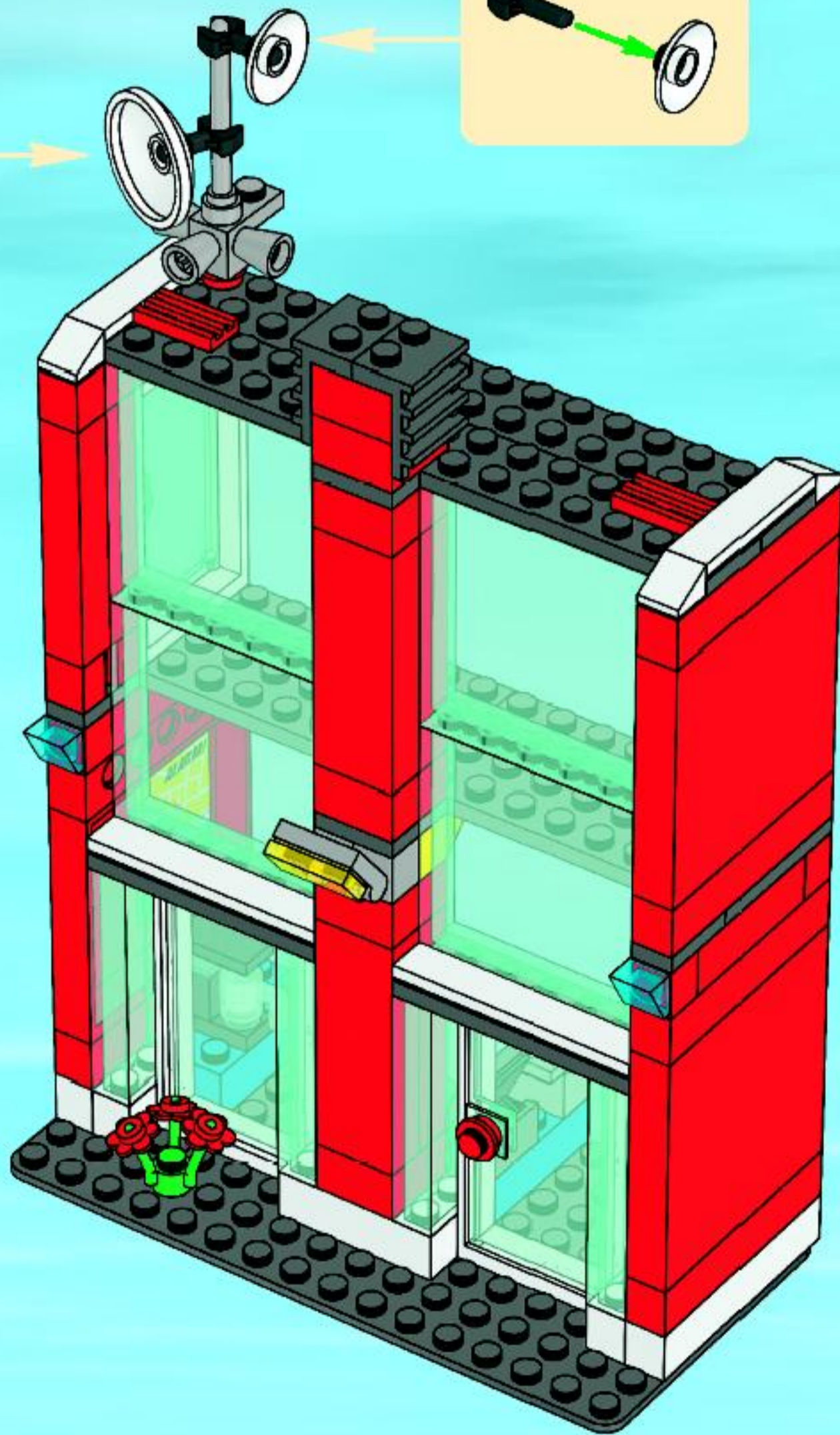



1

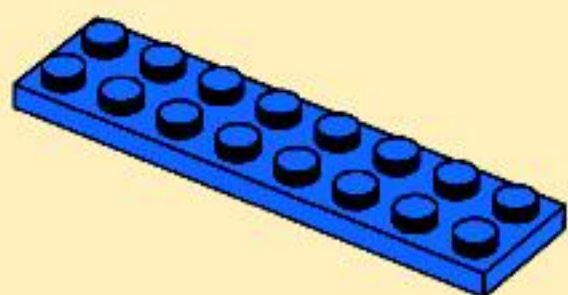

2

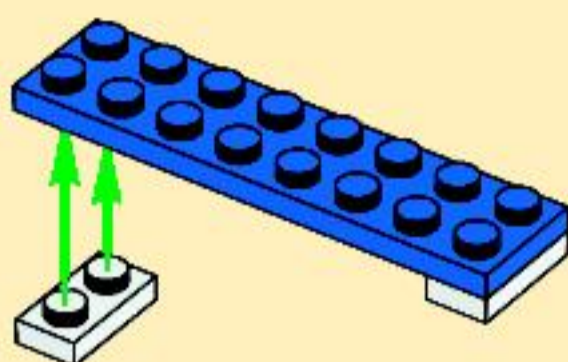

3

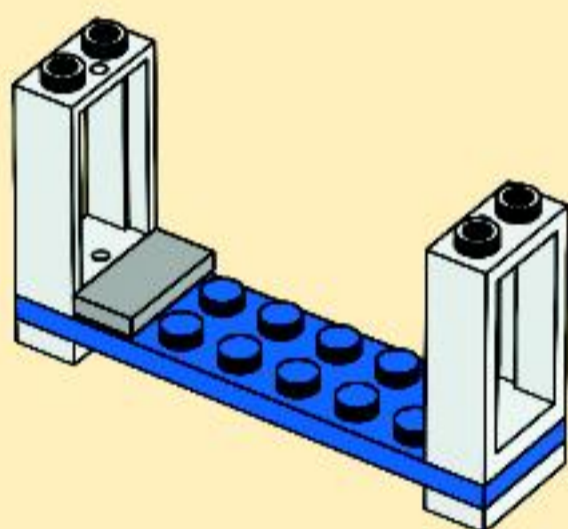

4

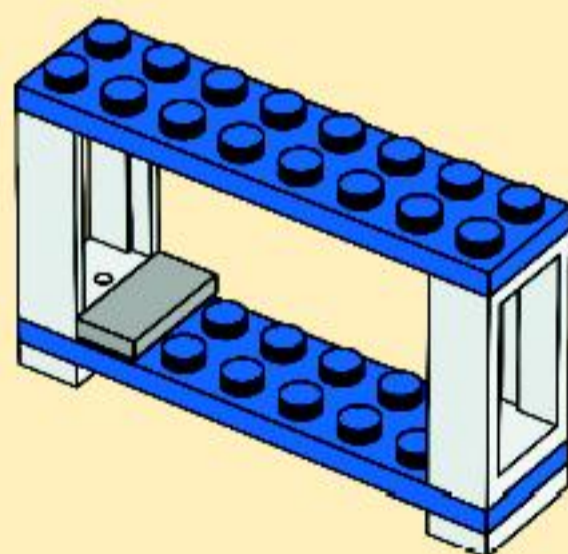

5

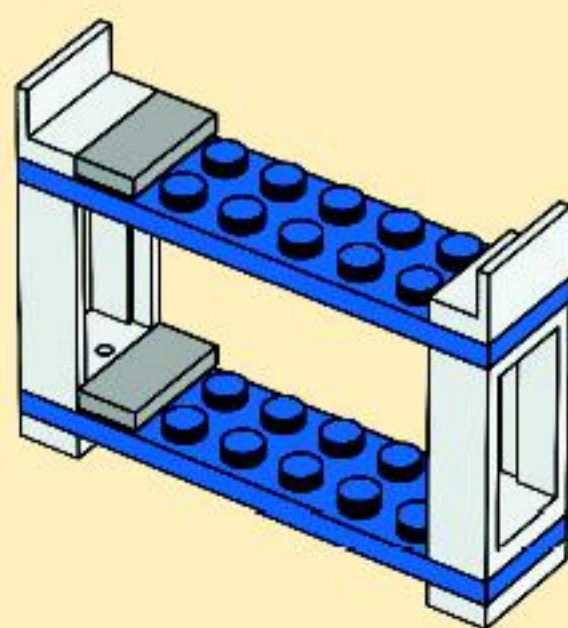

33

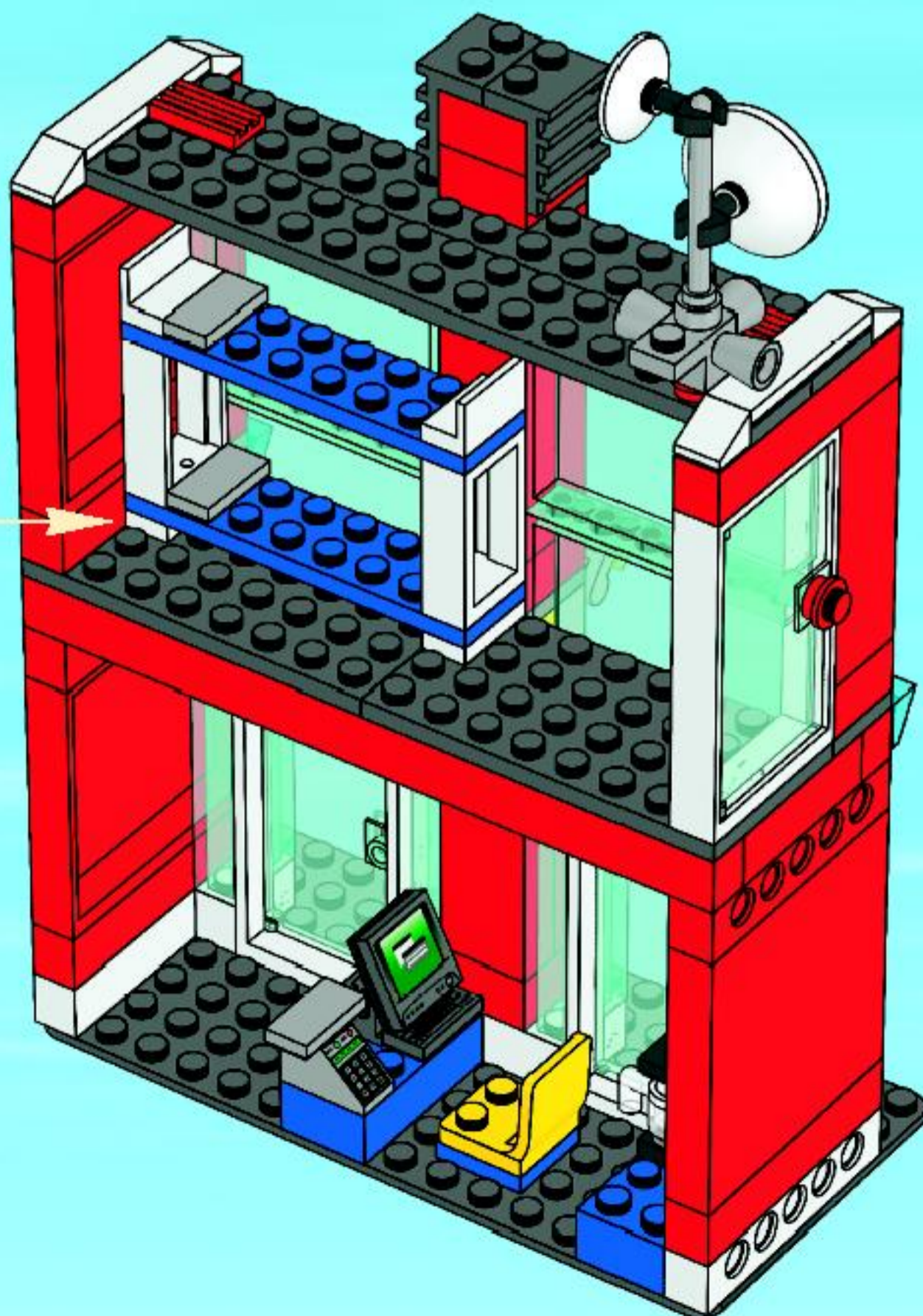



34

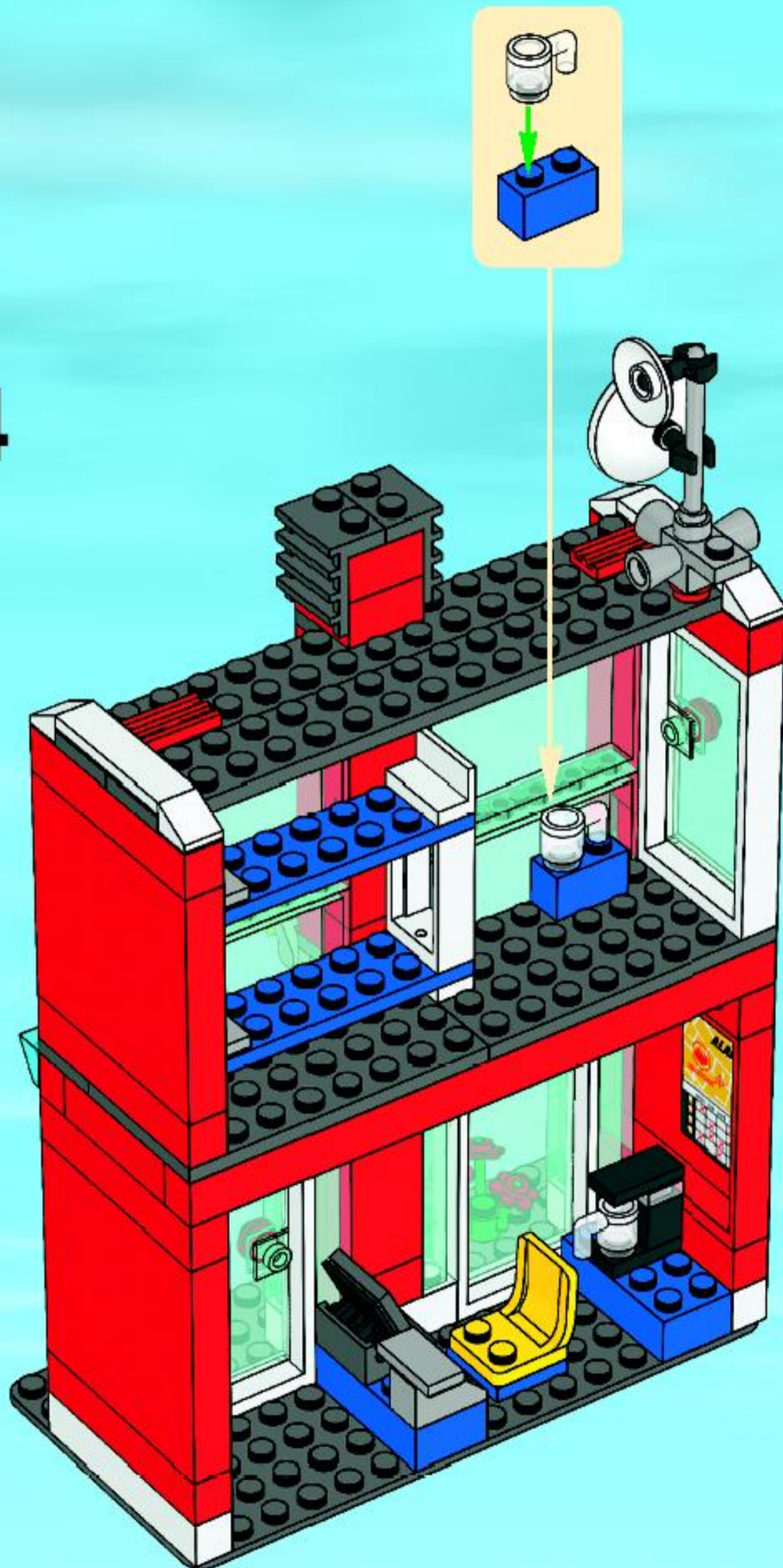



35

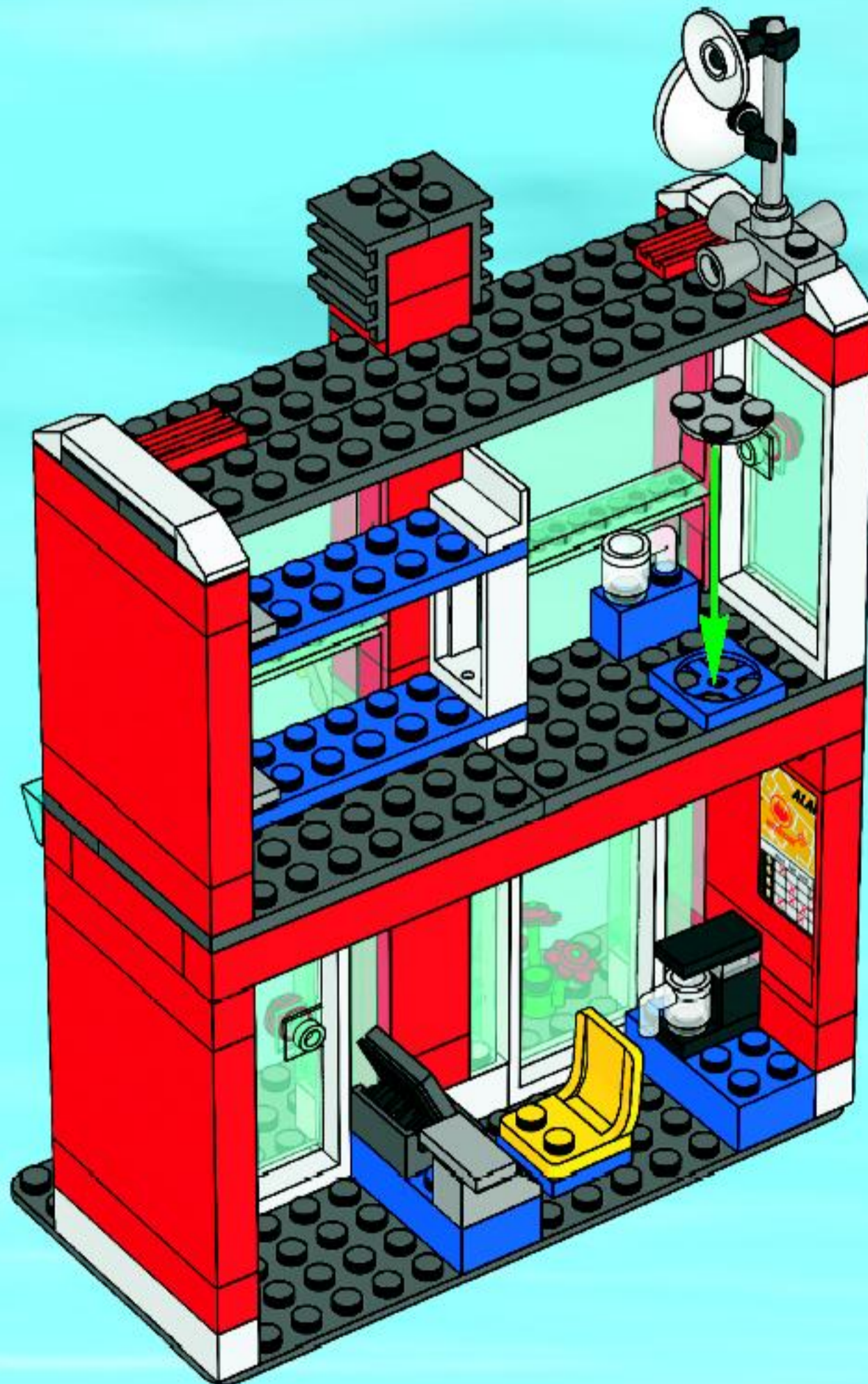



36





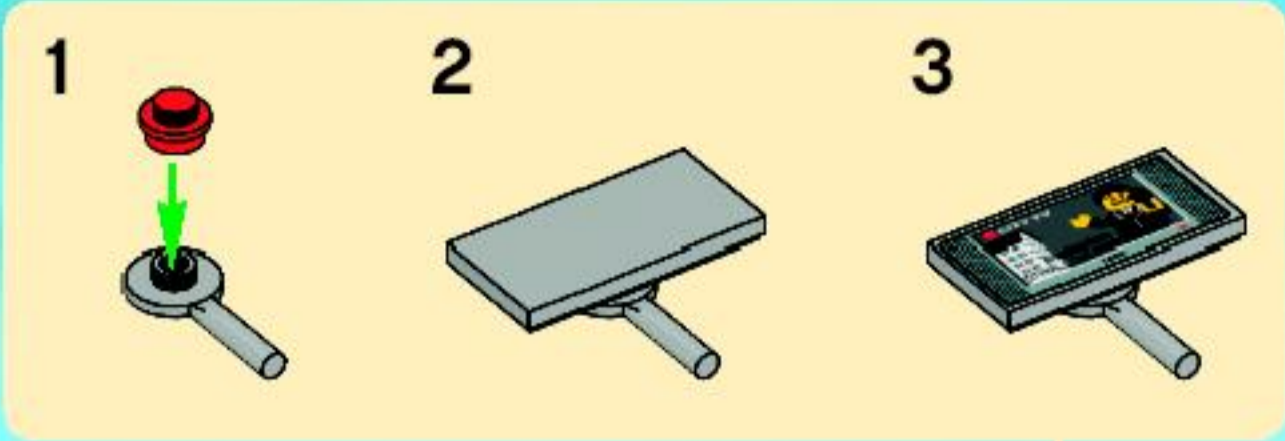

37

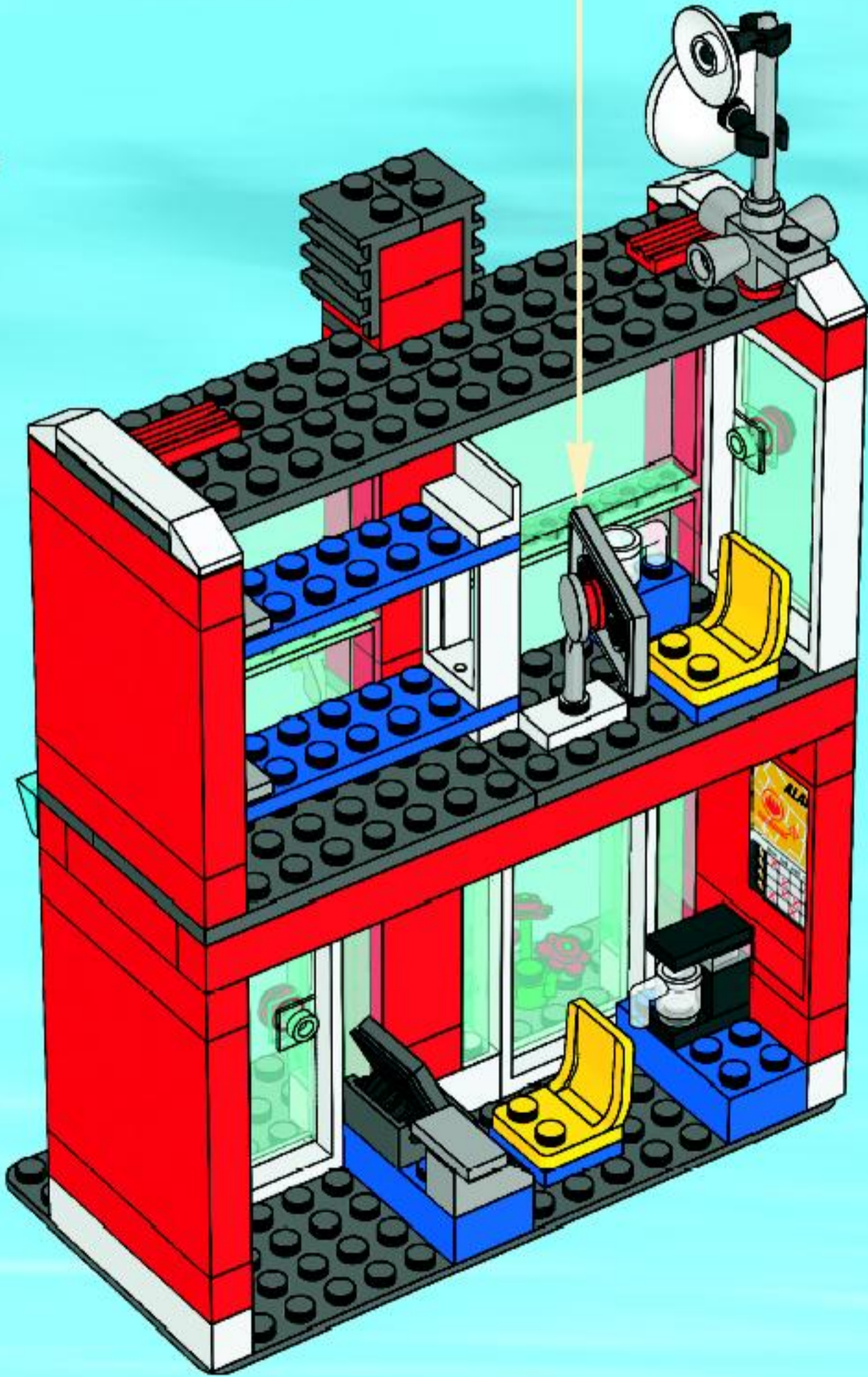



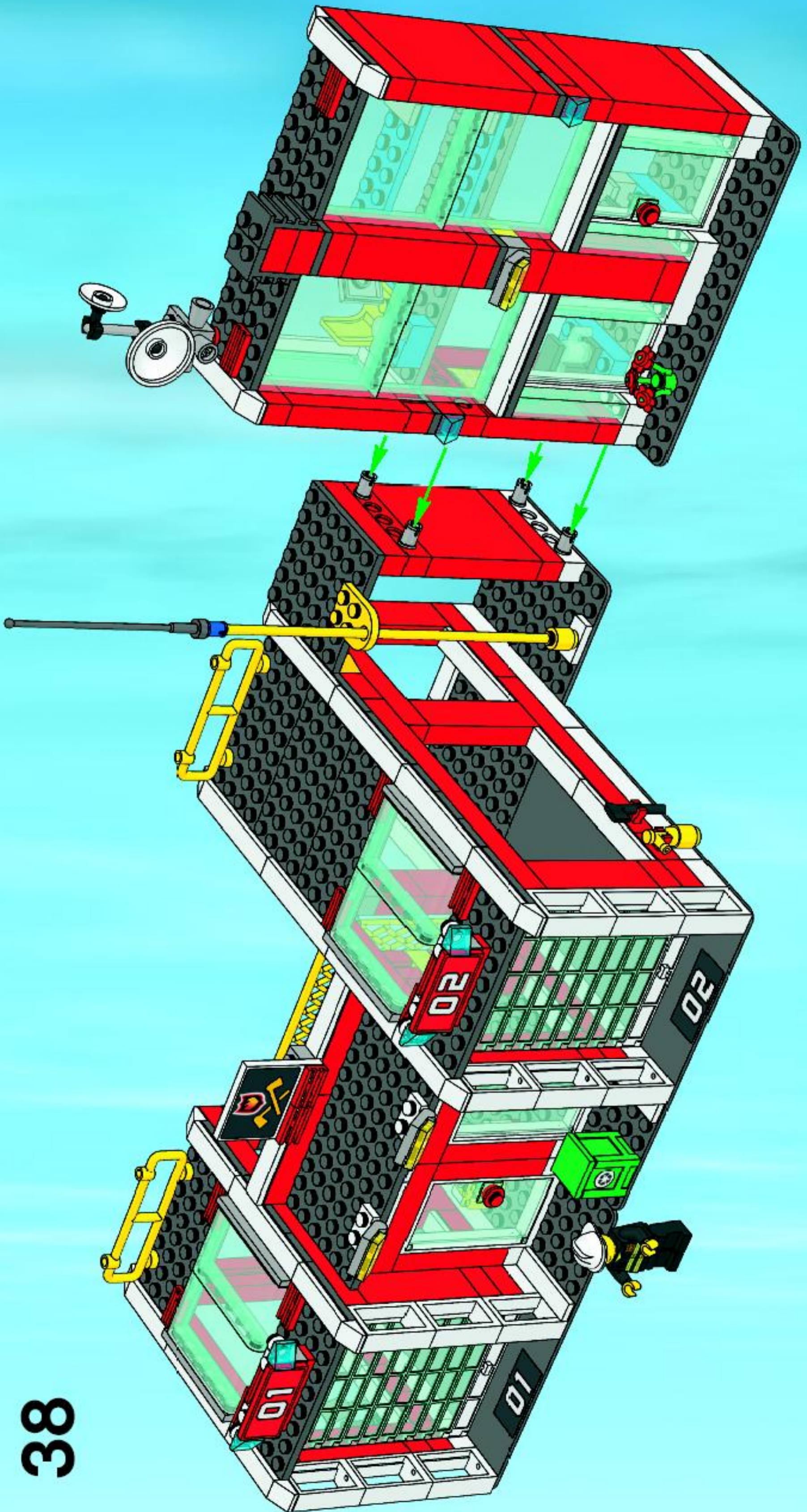

38



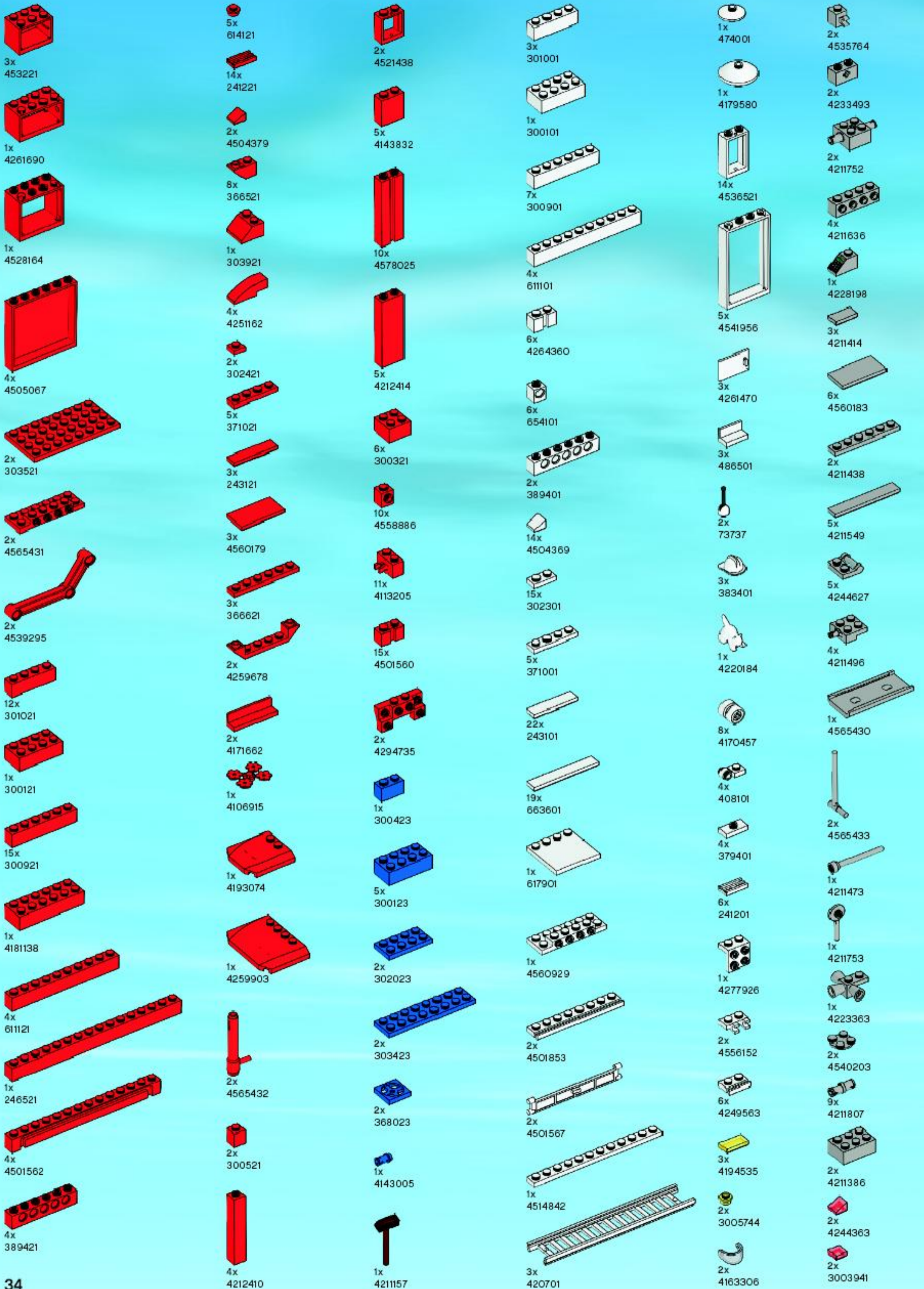



- 1x 4107762
- 1x 4548102
- 1x 374128
- 1x 347128
- 3x 383526
- 2x 396226
- 8x 4514560
- 2x 4289538
- 1x 4124096
- 1x 4262023
- 1x 4517986
- 1x 300526
- 1x 306926
- 1x 302326
- 2x 615726
- 4x 4275338
- 4x 9339
- 6x 383226
- 1x 4210642
- 1x 4558959
- 1x 4259673
- 5x 4211002
- 1x 4211134
- 2x 4211061
- 1x 4210794
- 6x 4211122
- 1x 4256149
- 2x 4210796
- 2x 4226978
- 2x 4260321
- 1x 4493478
- 3x 4211063
- 2x 4211094
- 1x 4288298
- 2x 4211053
- 13x 4543086
- 2x 4210801
- 1x 4227517
- 2x 4521386
- 2x 4261469
- 1x 4211006
- 6x 4260124
- 1x 4211066
- 2x 4211128
- 4x 4283915
- 2x 4552034
- 2x 4500813
- 3x 4520866
- 2x 3000742
- 4x 4505000
- 18x 4258476
- 1x 4228126
- 5x 4546691
- 3x 306224
- 5x 366024
- 1x 4188313
- 2x 4256320
- 4x 407924
- 2x 243224
- 1x 4570663
- 1x 4578503
- 1x 4261301
- 1x 4194017
- 2x 383824
- 2x 9553
- 2x 4189225
- 1x 4562530
- 4x 4244362
- 1x 3000840
- 1x 3001140
- 2x 626440
- 12x 4244366
- 6x 4113854
- 8x 3005743
- 2x 4244369
- 1x 4260036
- 1x 4118600
- 1x 4262022



1x 4118600

1x 4262022

Customer Service  
Kundenservice  
Service Consommateurs  
Servicio Al Consumidor

[www.lego.com/service](http://www.lego.com/service) or dial

: 00800 5346 5555  
 : 1-800-422-5346





# WIN!

Go to [www.nielsen.com/LEGO](http://www.nielsen.com/LEGO) to fill out a survey for a chance to win a cool LEGO® Product. No purchase necessary. Open to all residents where not prohibited.

 [www.LEGO.com](http://www.LEGO.com)



## [www.nielsen.com/LEGO](http://www.nielsen.com/LEGO)

### GEWINNE!

Nimm an der Umfrage auf [www.nielsen.com/LEGO](http://www.nielsen.com/LEGO) teil und hab die Chance ein cooles LEGO® Produkt zu gewinnen!

Die Teilnahme am Gewinnspiel führt zu keinerlei Kaufverpflichtungen. Teilnahme in allen nicht ausgeschlossenen Ländern möglich.

### WIN!

Ga naar [www.nielsen.com/LEGO](http://www.nielsen.com/LEGO), vul een enquêteformulier in en maak kans op een cool LEGO® product.

Geen aankoopverplichting. Iedereen mag deelnemen, uitgezonderd ingezetenden van landen waar een enquêteverbod geldt.

### GAGNE!

Visite [www.nielsen.com/LEGO](http://www.nielsen.com/LEGO) pour répondre à un questionnaire et avoir une chance de gagner un produit LEGO® très cool!

Aucune obligation d'achat. Ouvert à tous les résidents des pays autorisés.

### 当てよう!

[www.nielsen.com/LEGO](http://www.nielsen.com/LEGO)にアクセスして、アンケートにご記入ください。当選者にはレゴ製品を差し上げます。

お買い上げの必要はありません。禁止されていない限り、すべての情報にご利用いただけます。