



# ATLANTIS

8075



1

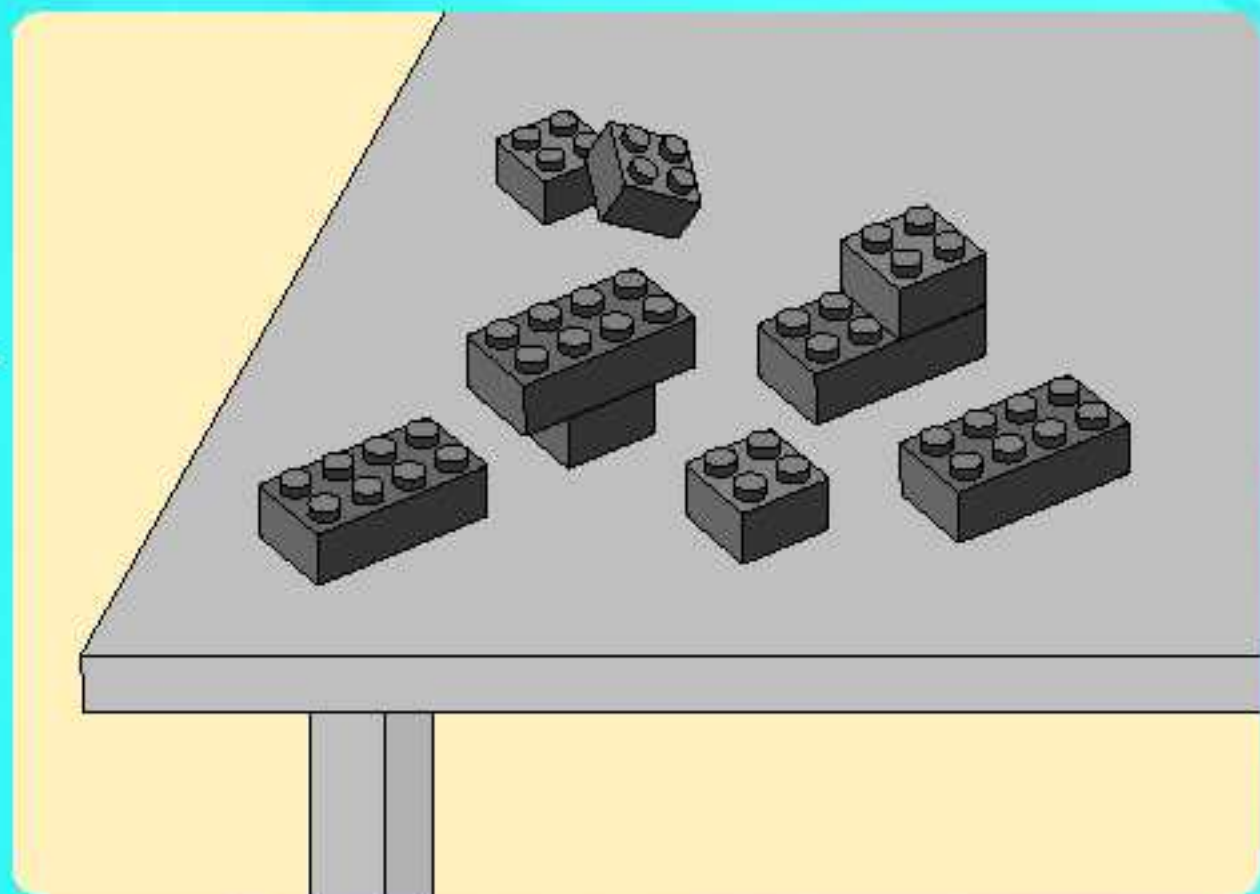
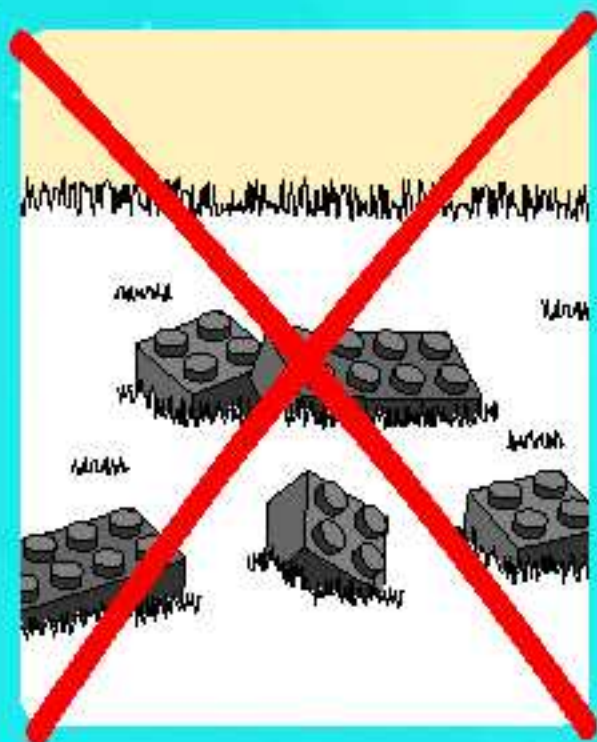

2



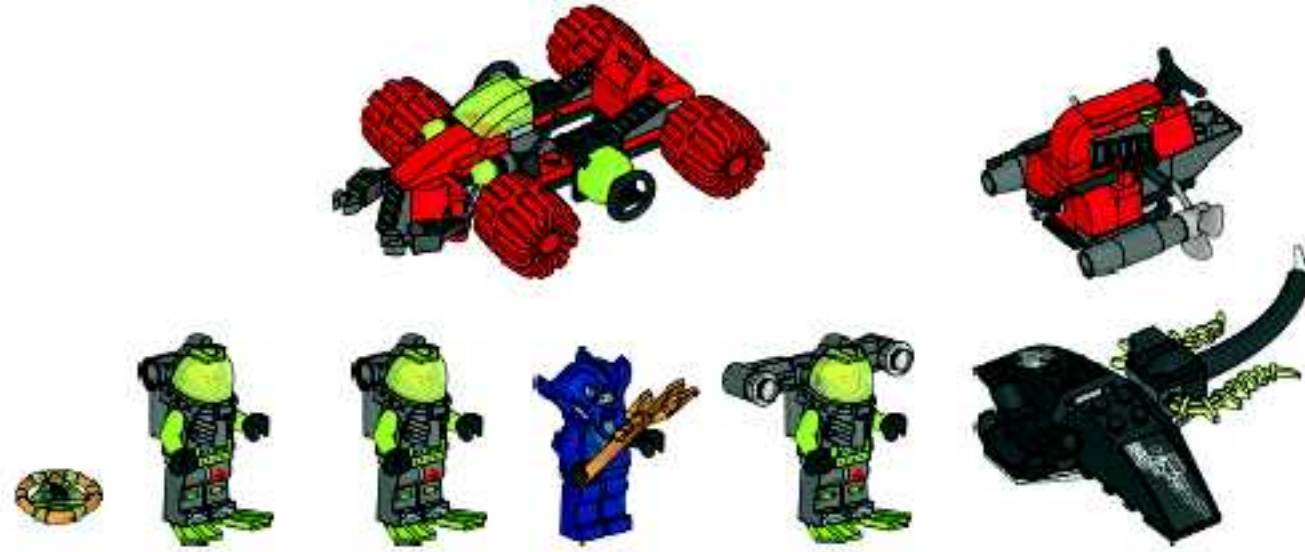

3

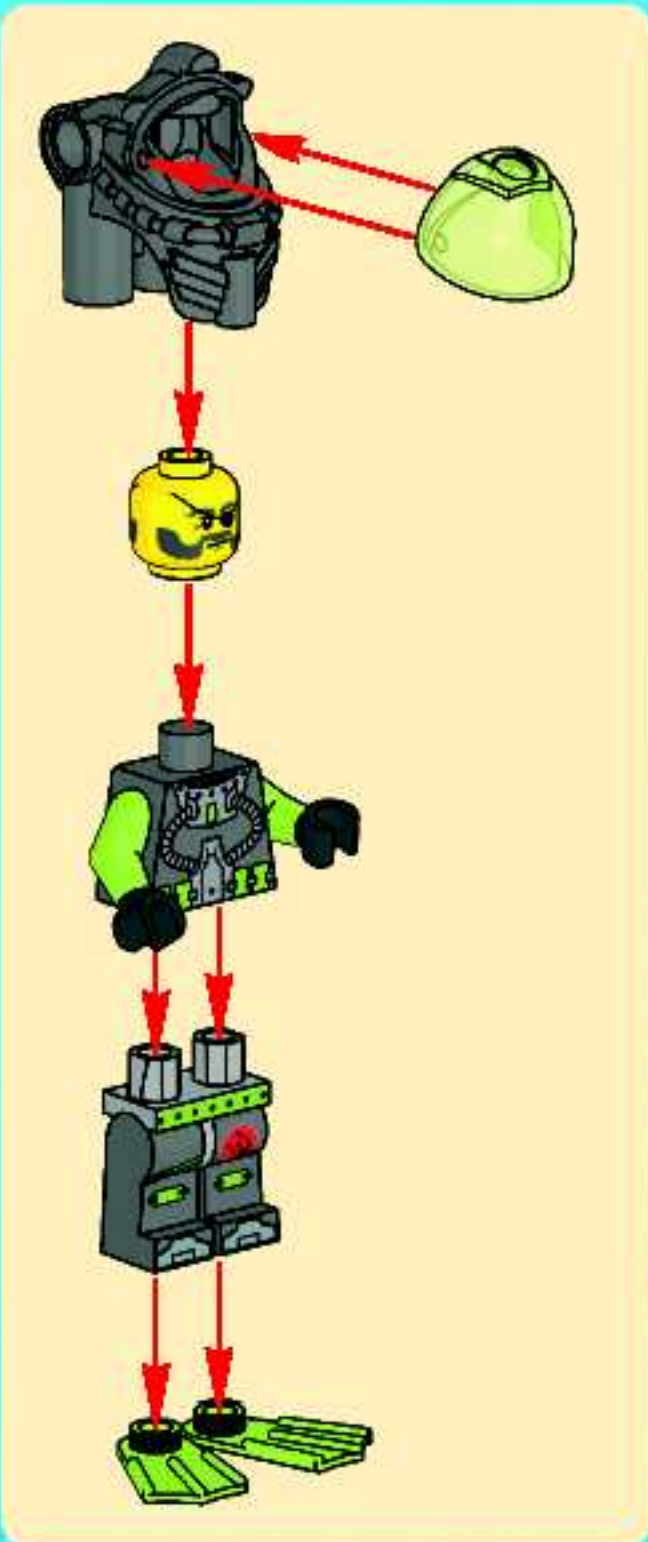

1

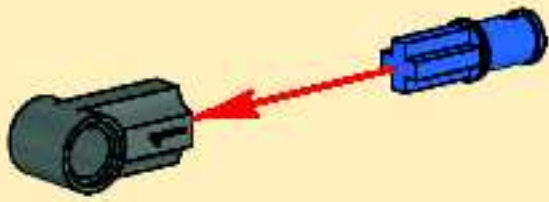

2

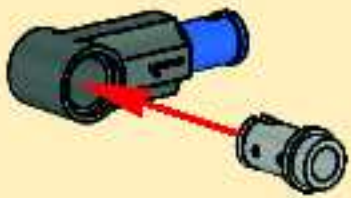

3



2x



1x

1





1x



1x

# 2



1x



1x

# 3



2x

# 4

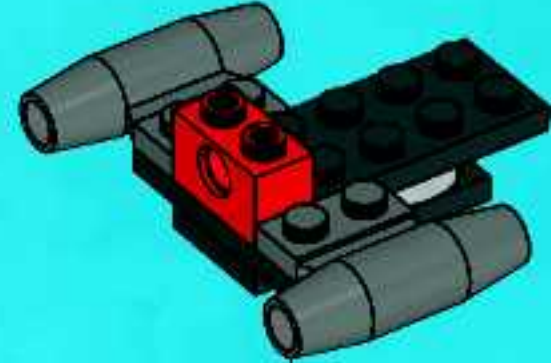

1x



1x



1x

# 5

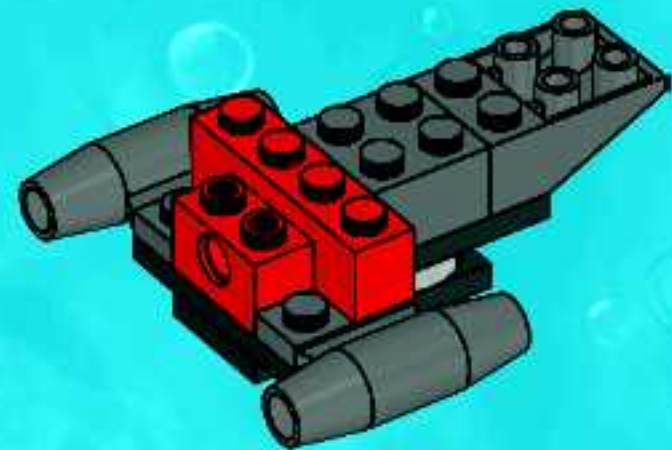



2x



1x

# 6

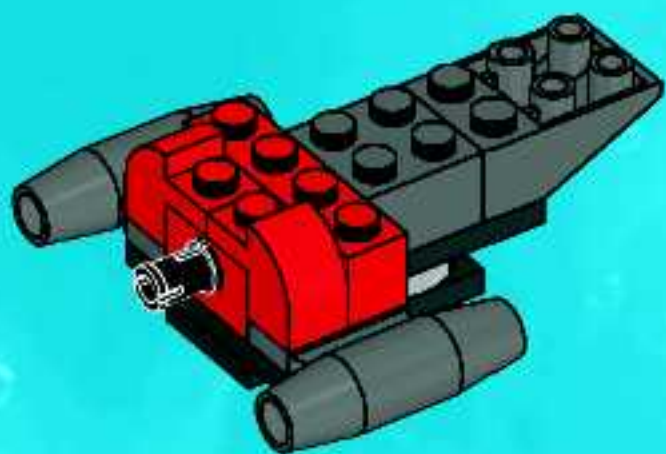

2x



3x



1x

# 7

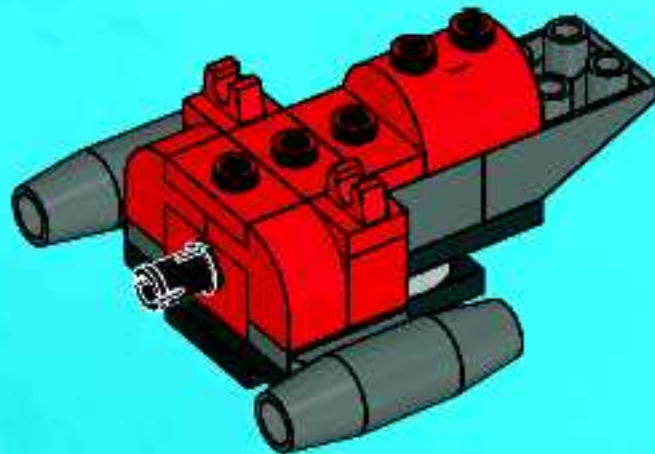



8

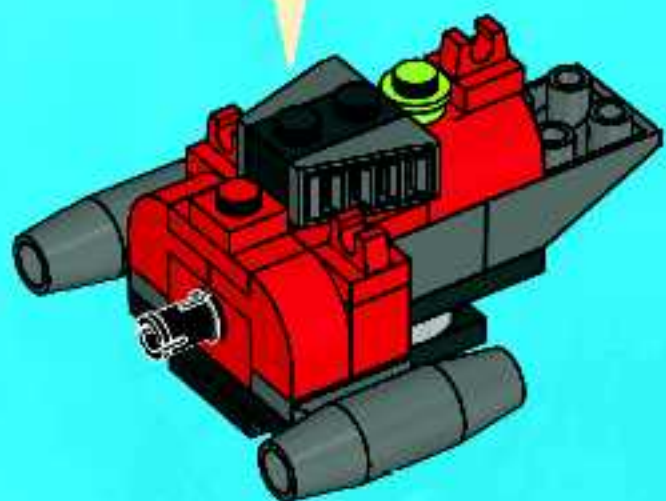
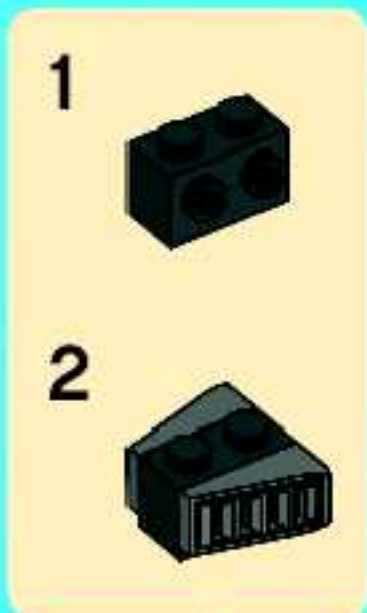

9

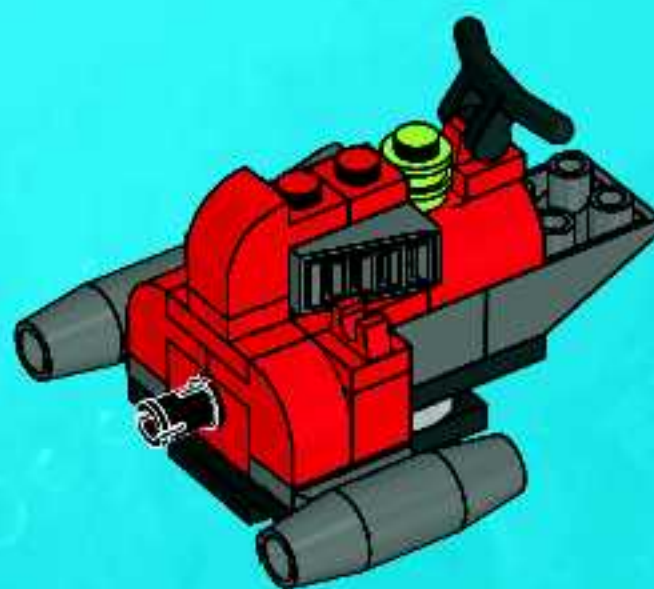

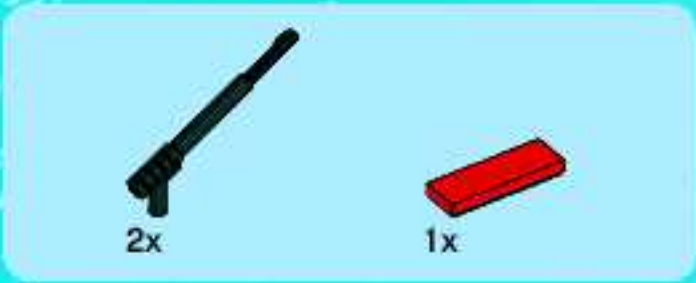

10

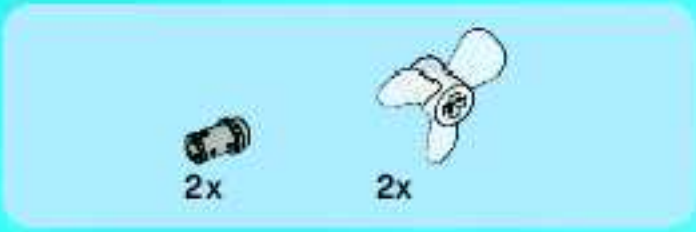
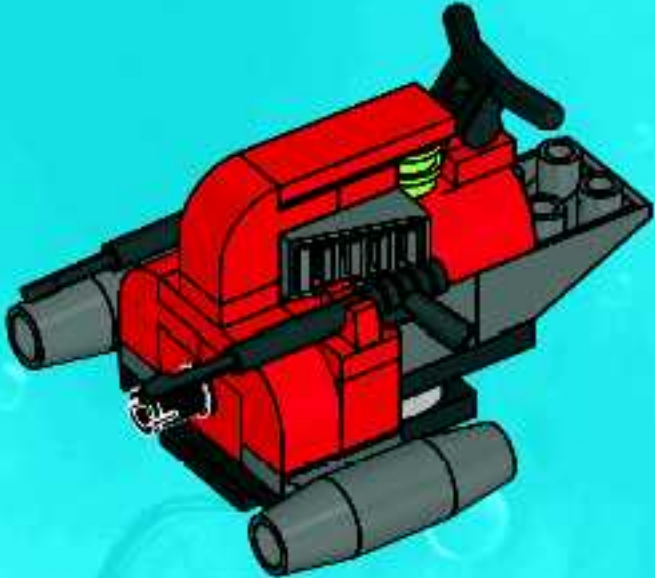

11

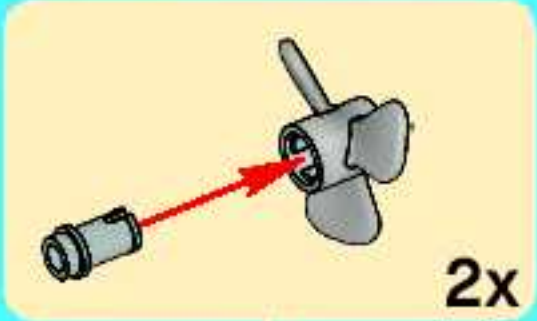



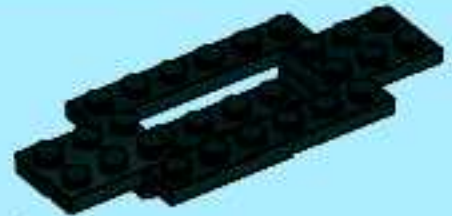
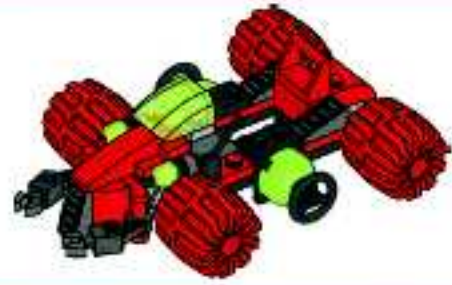

1x

1



1x



2x

2

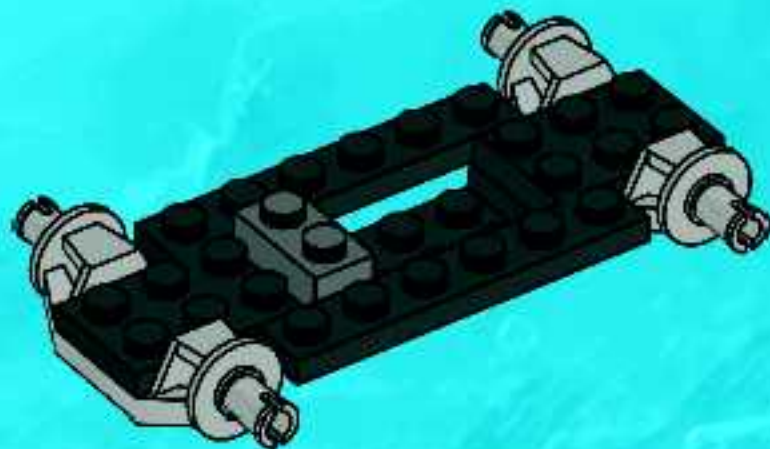

2x



1x

3

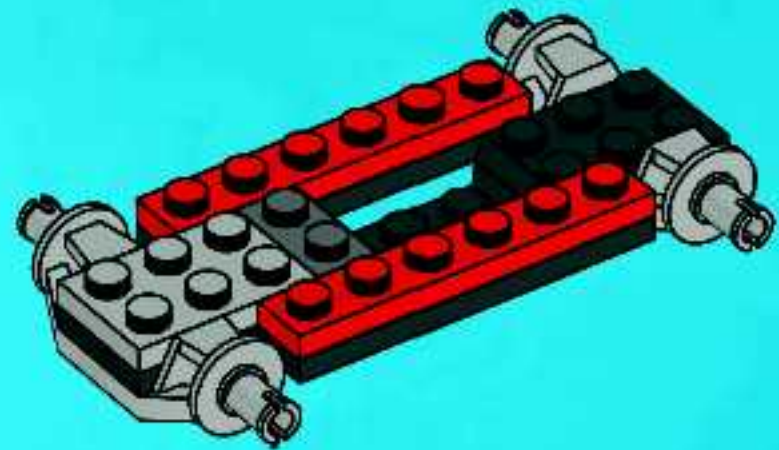

1x



2x



2x

4

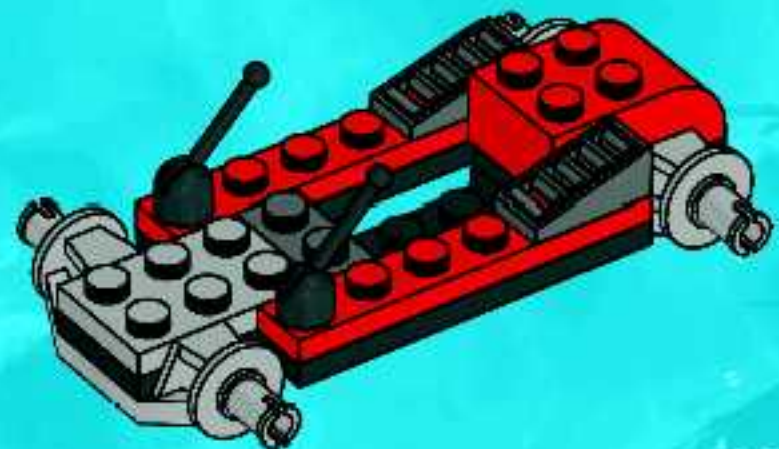



4x

5

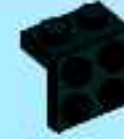
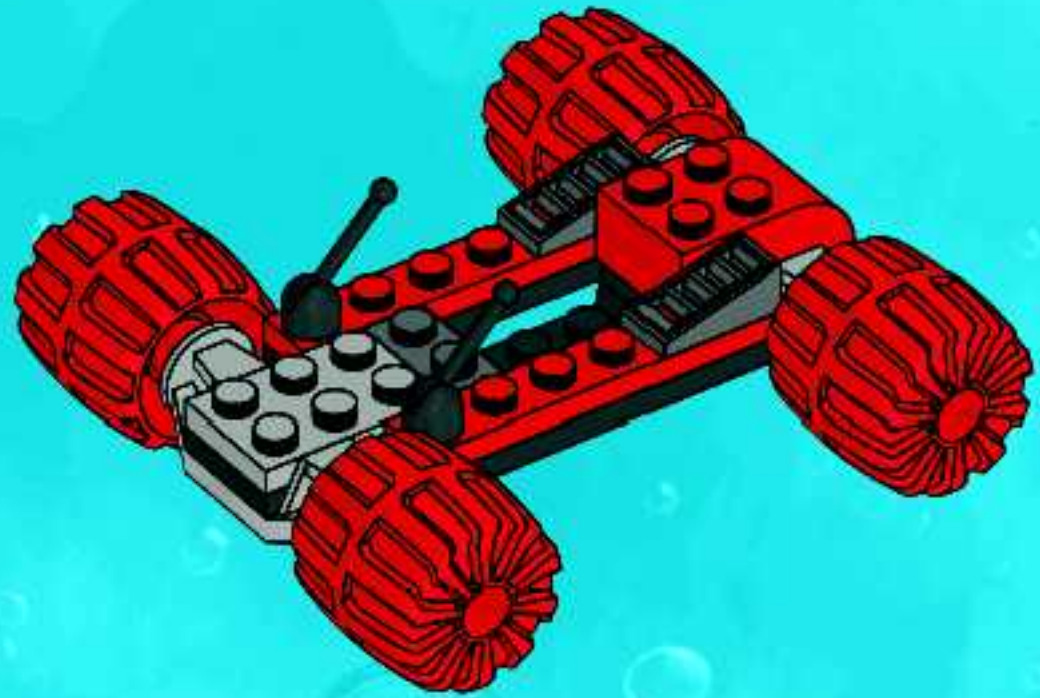

3x

6

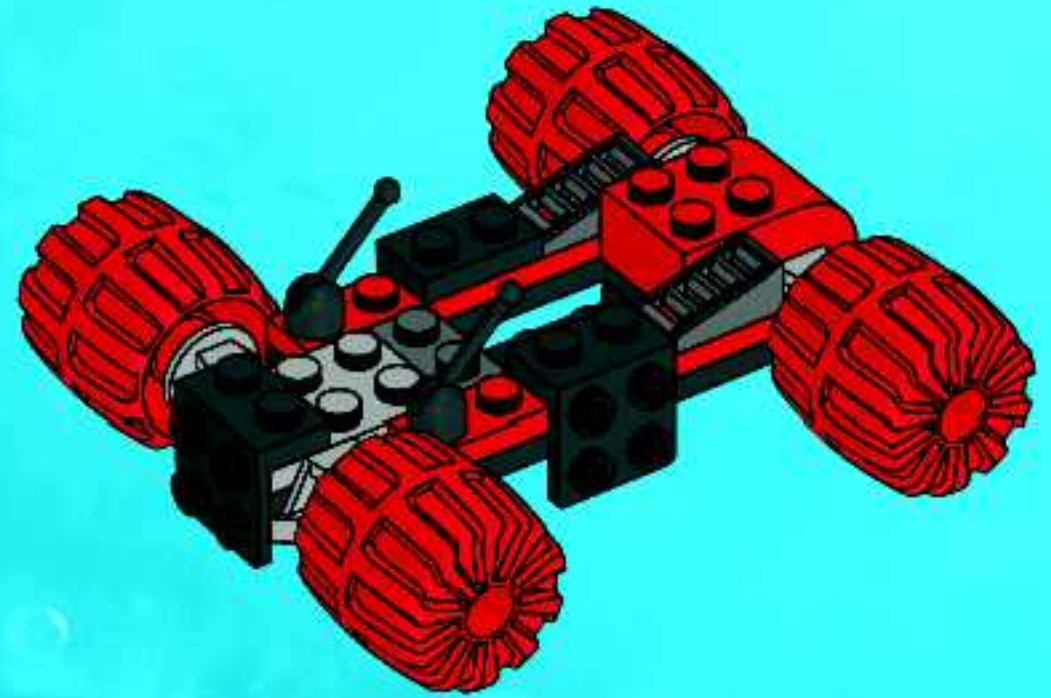



2x

7

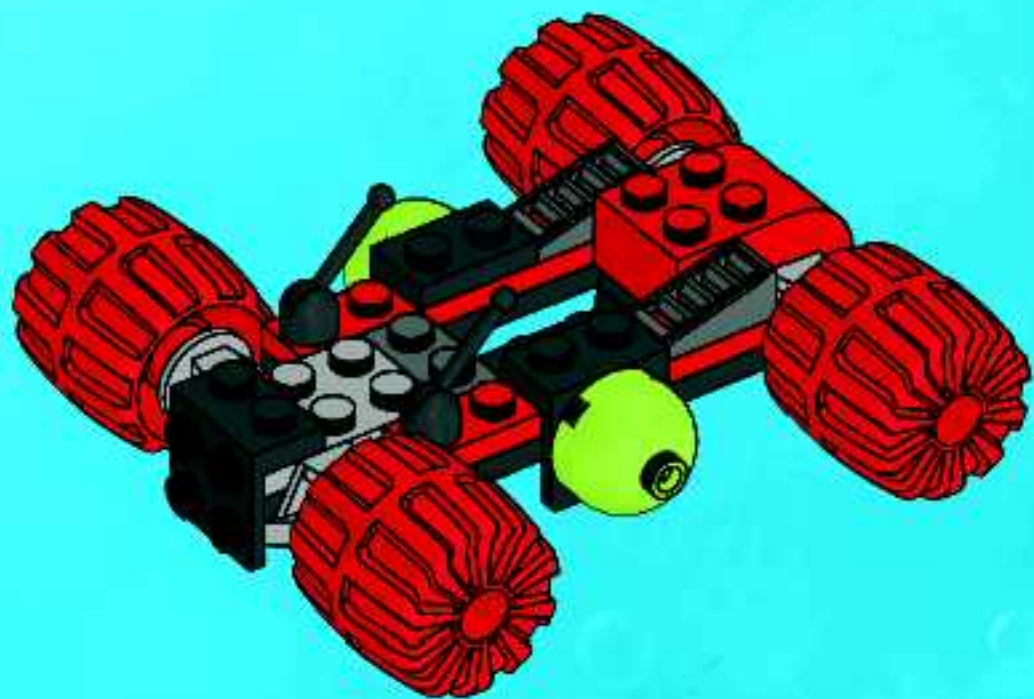

2x



1x

8

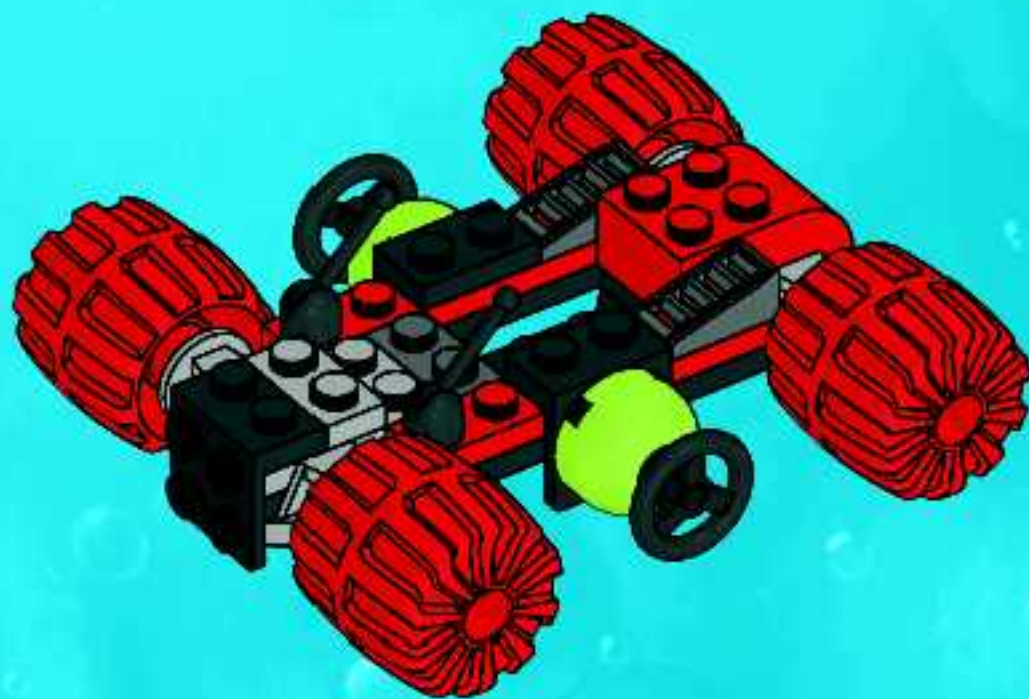



1x



2x

# 9

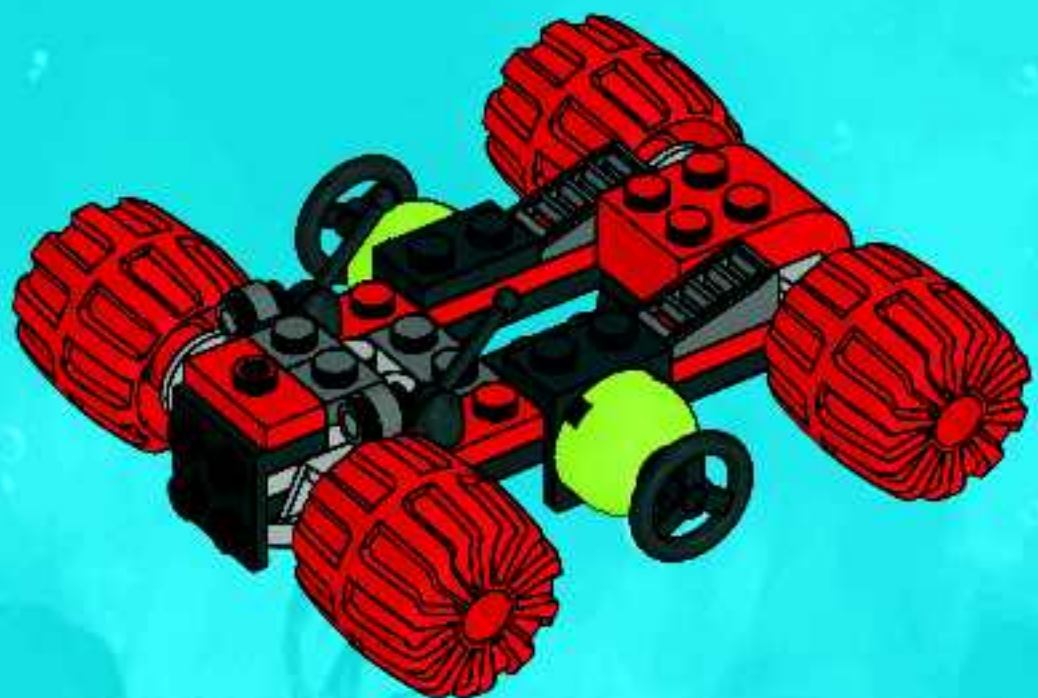

1x



1x



2x

# 10

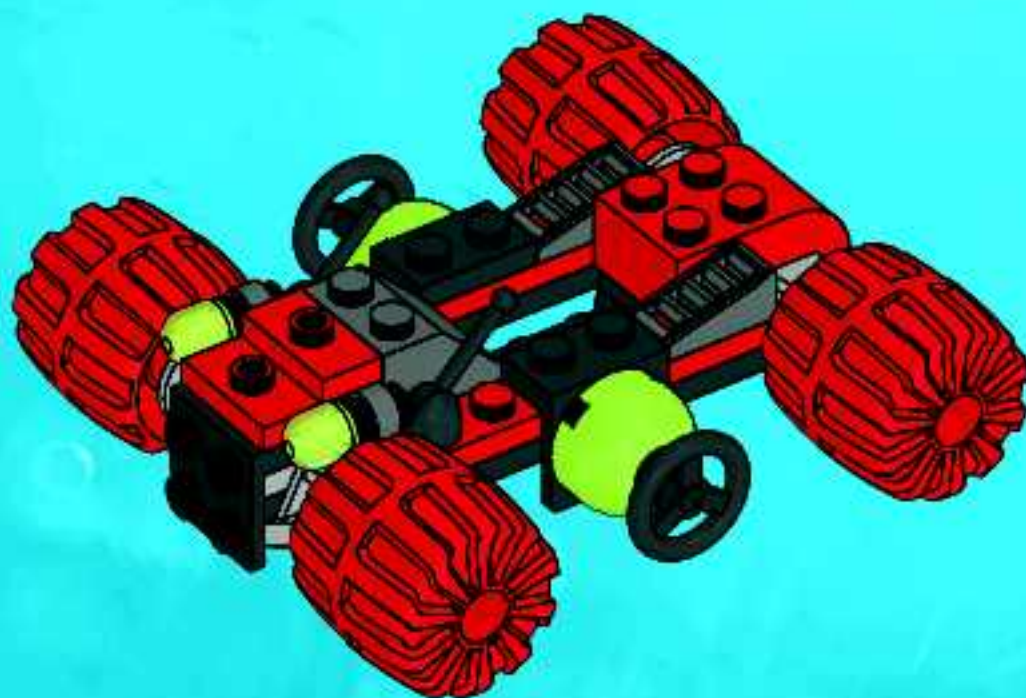



2x



1x



1x

# 11

1



2



3

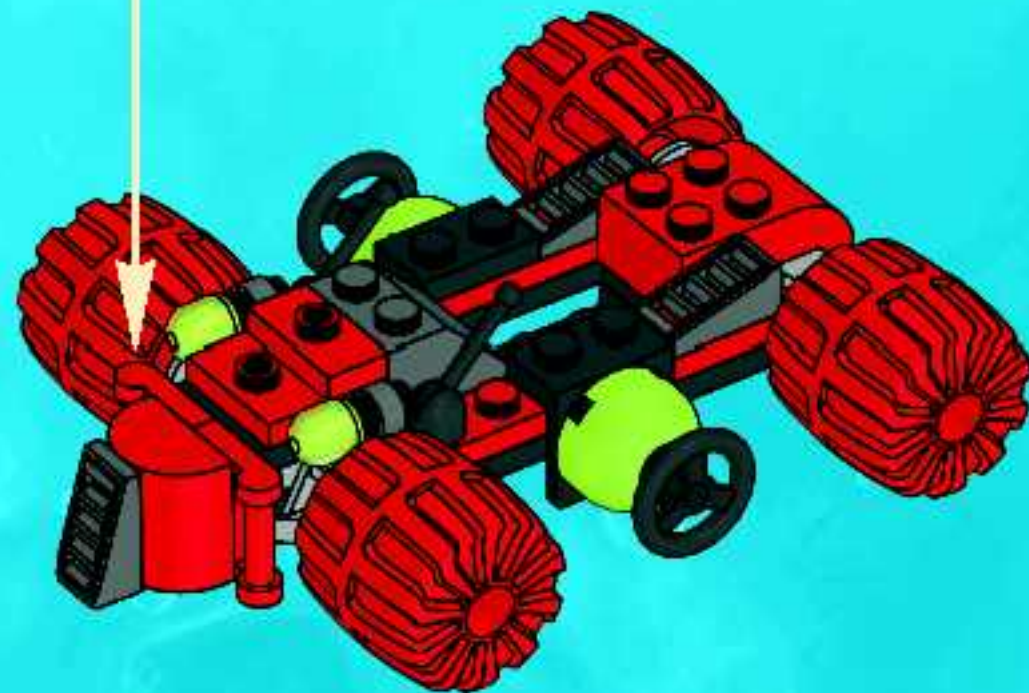
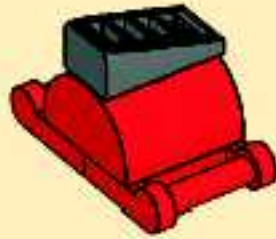



1x



1x



1x

# 12

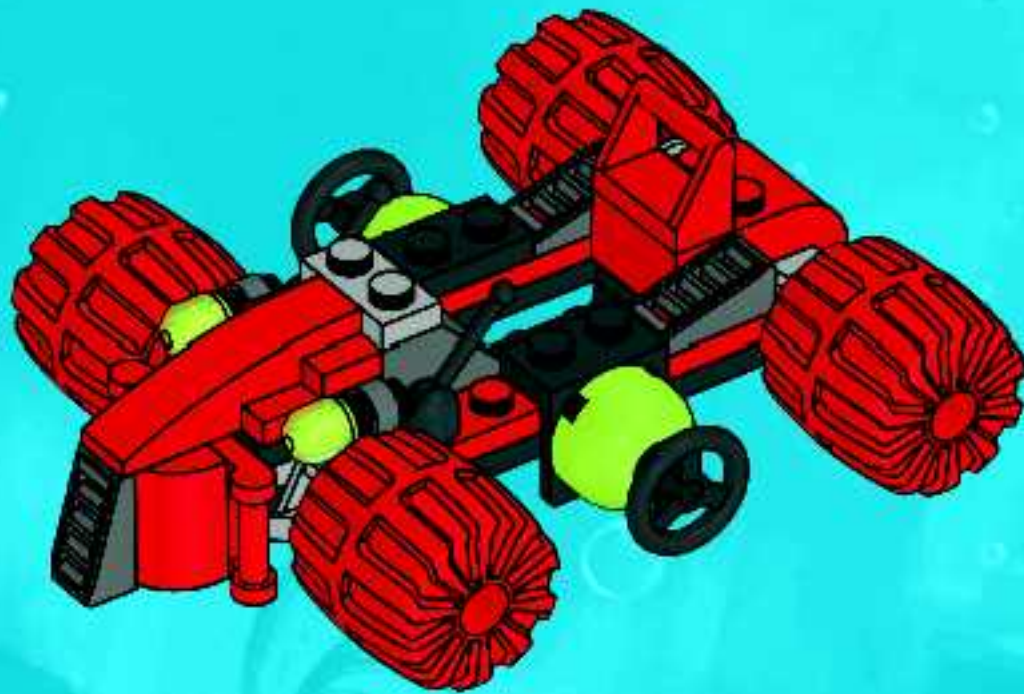

2x



1x



2x

# 13



2x

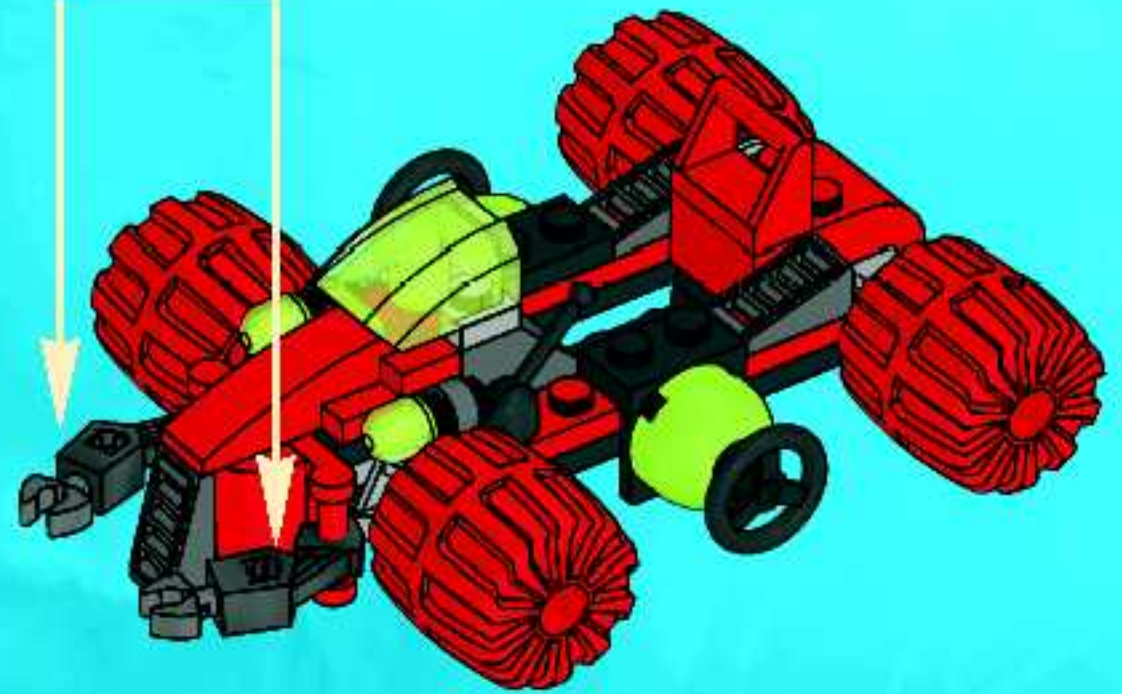



1



2

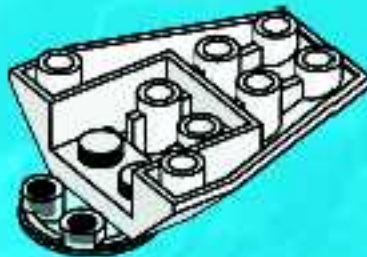

3

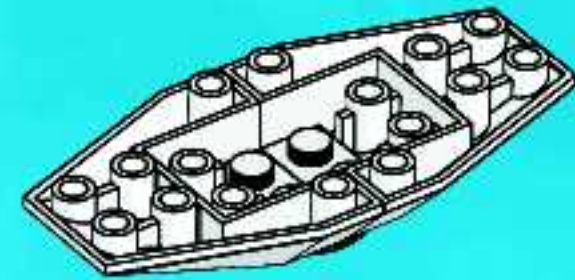

4

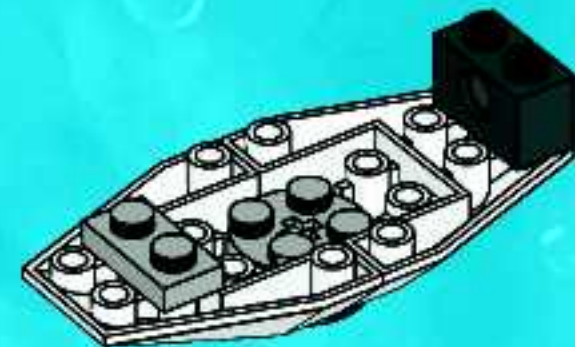

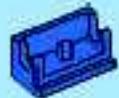

2x



1x



2x

# 5

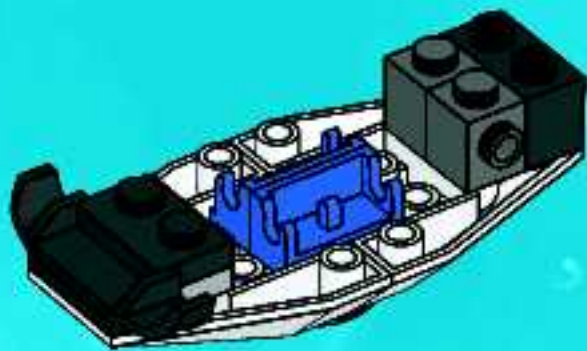

2x



2x



2x

# 6

1



2



3

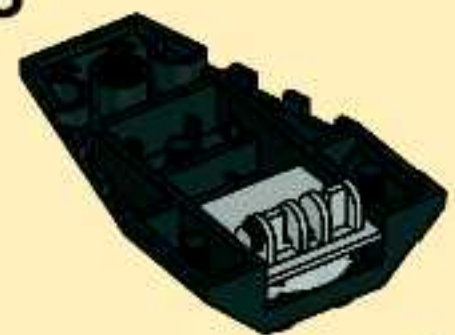

2x

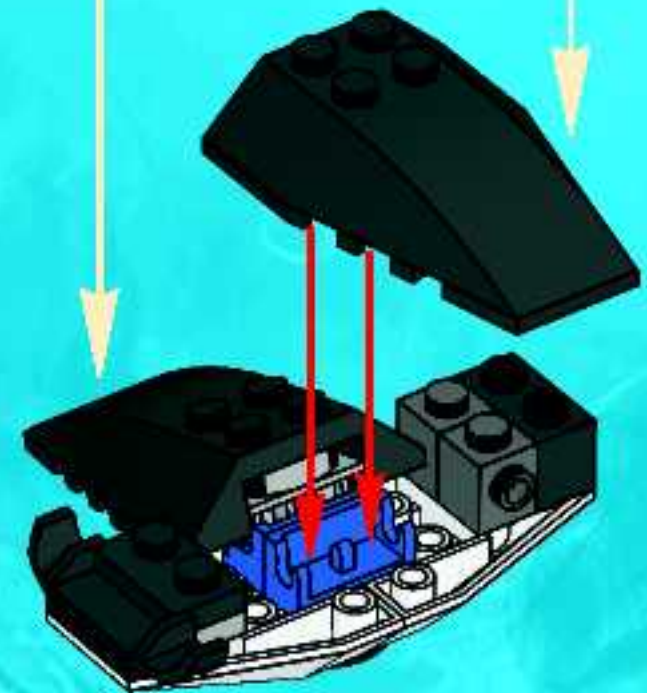





7

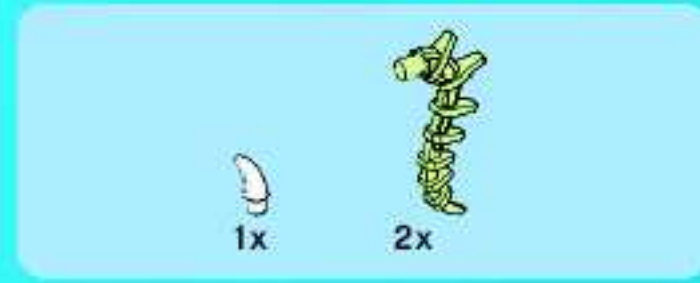

8



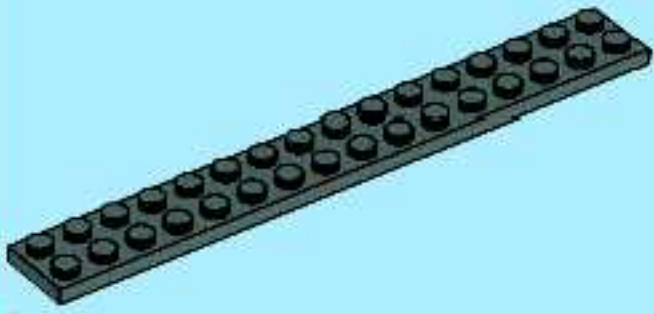
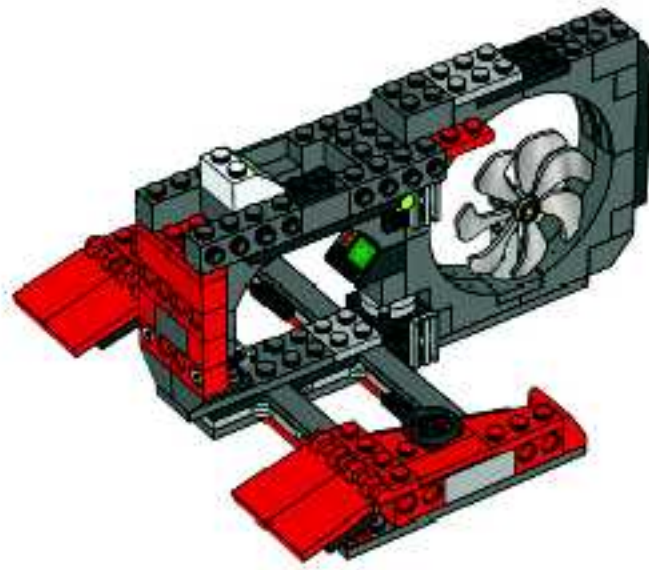

1x

1

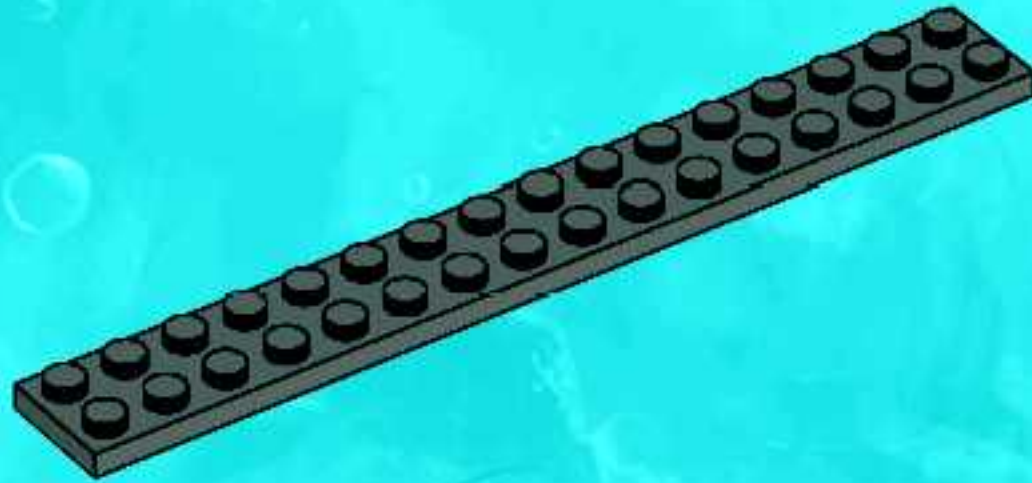



2x



2x

2

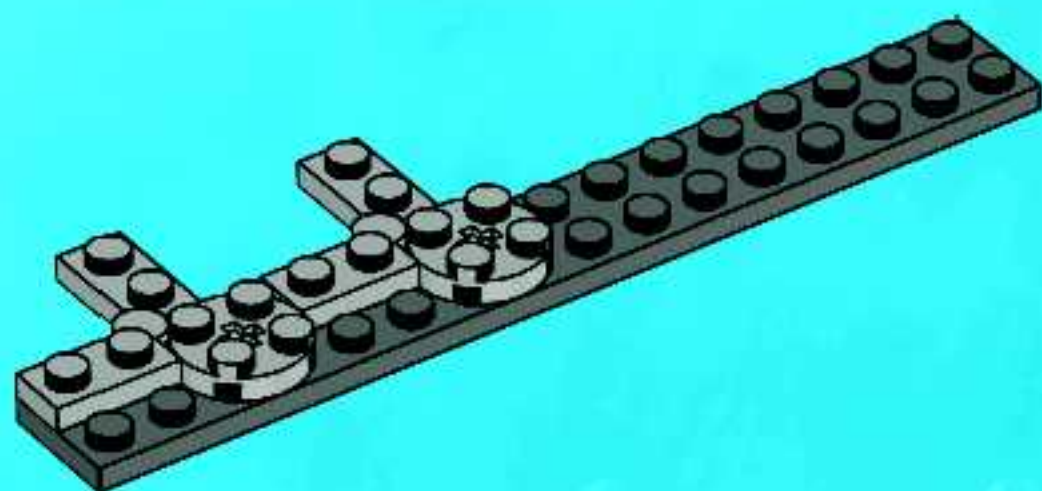

1x



2x

3

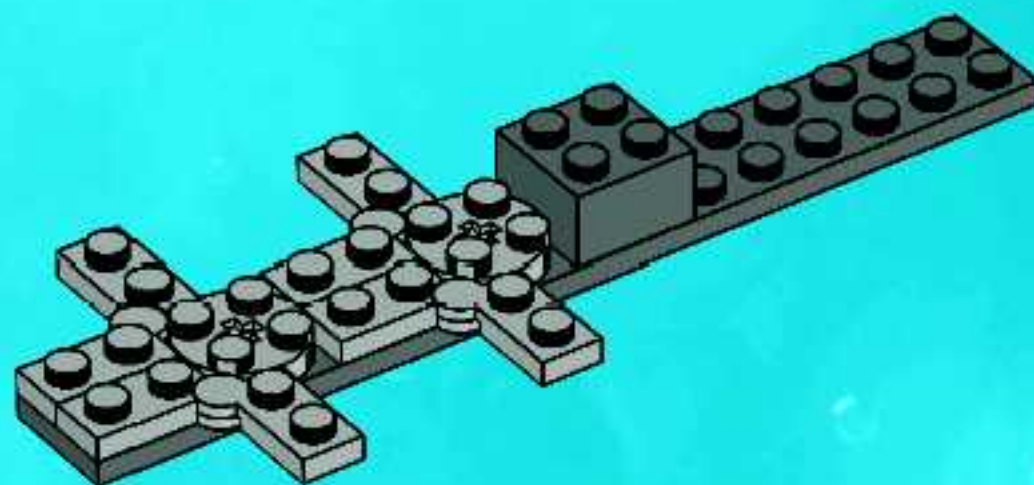



4

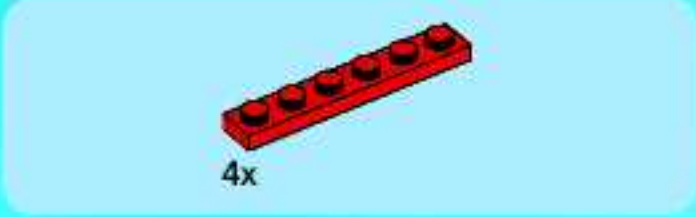
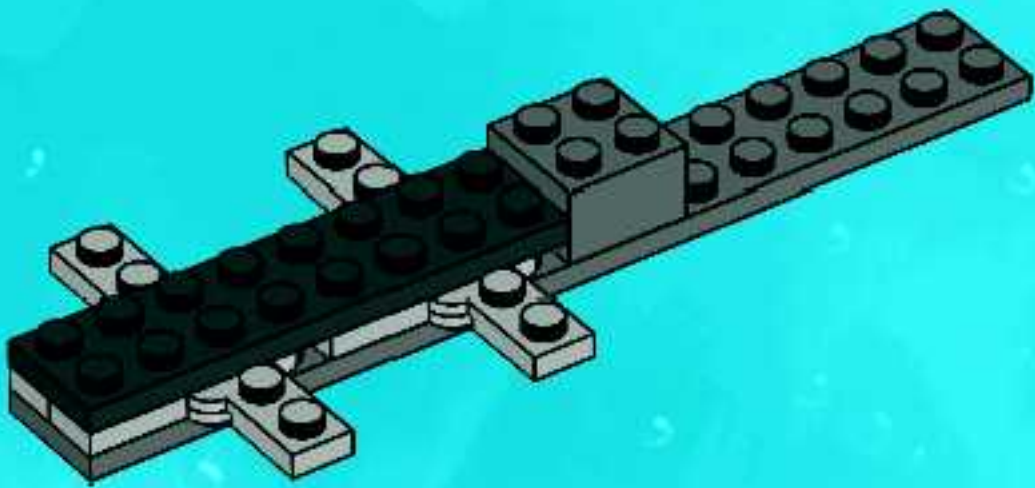

5

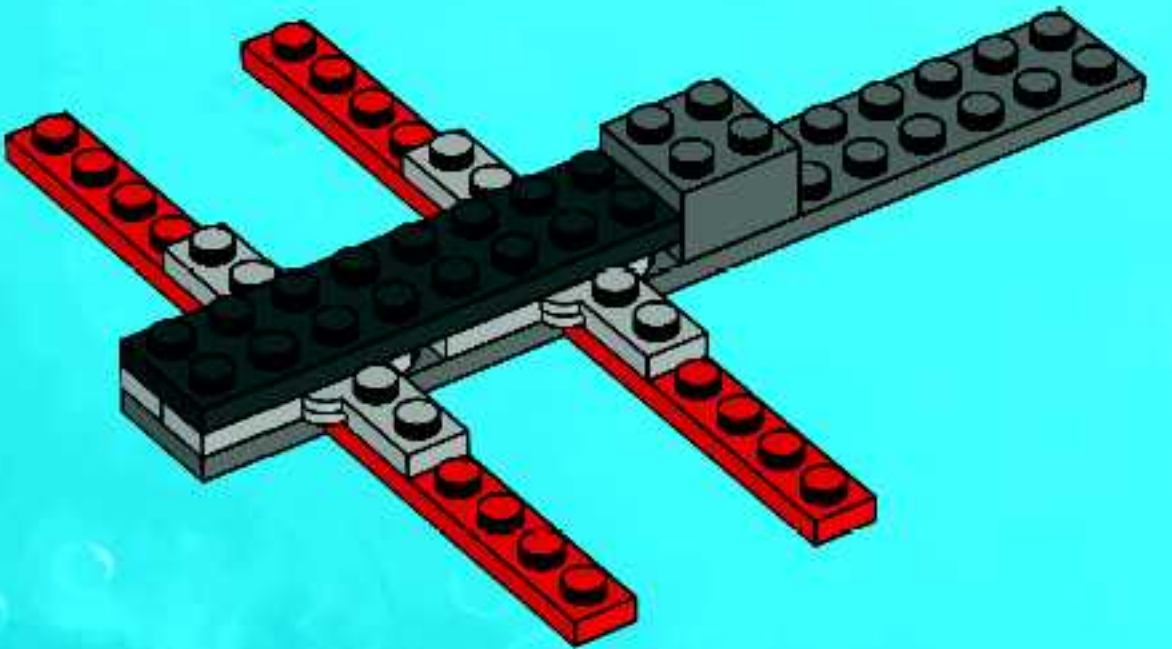



2x

6

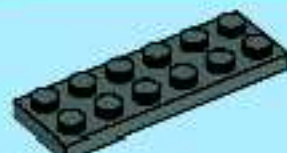
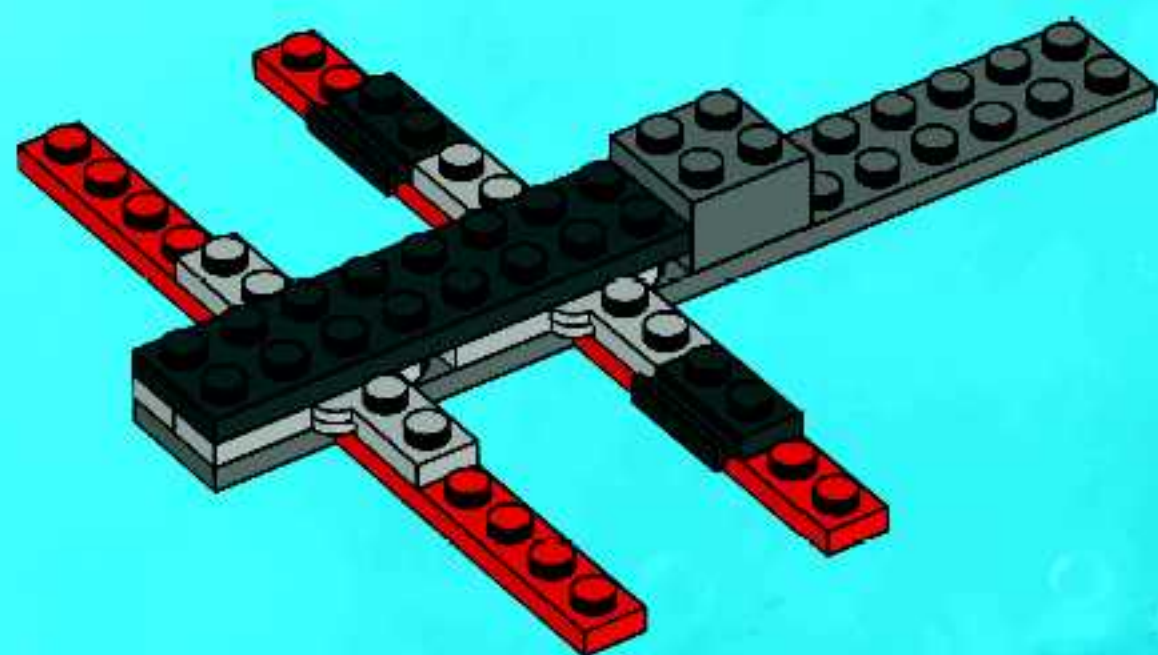

1x



1x

7

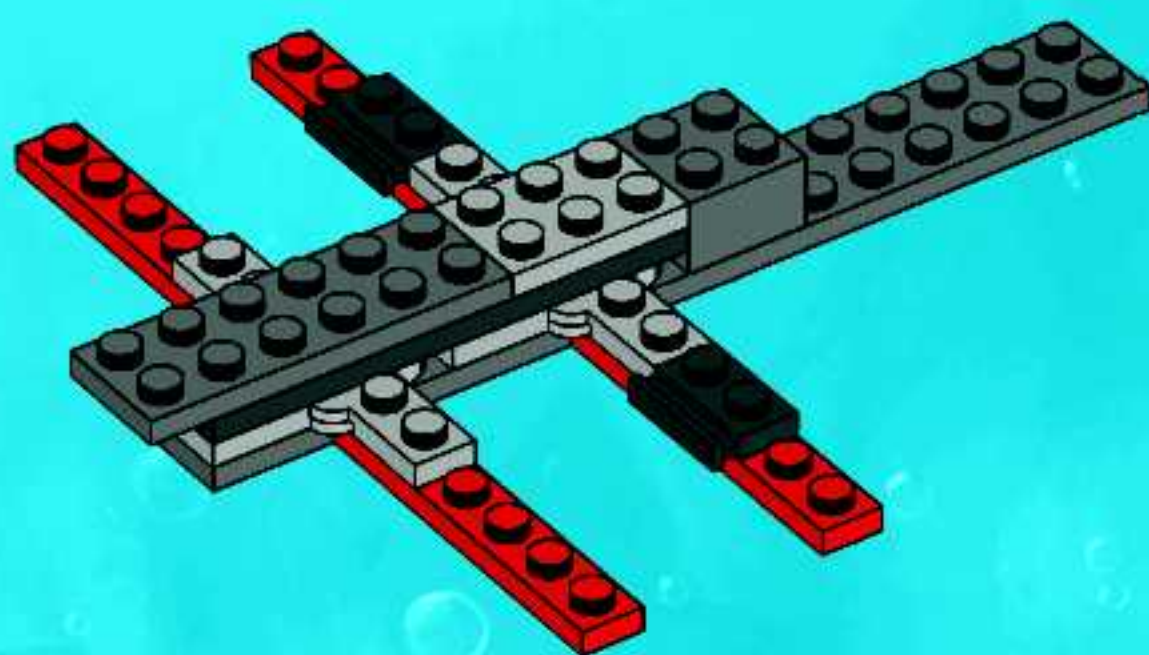



2x

8

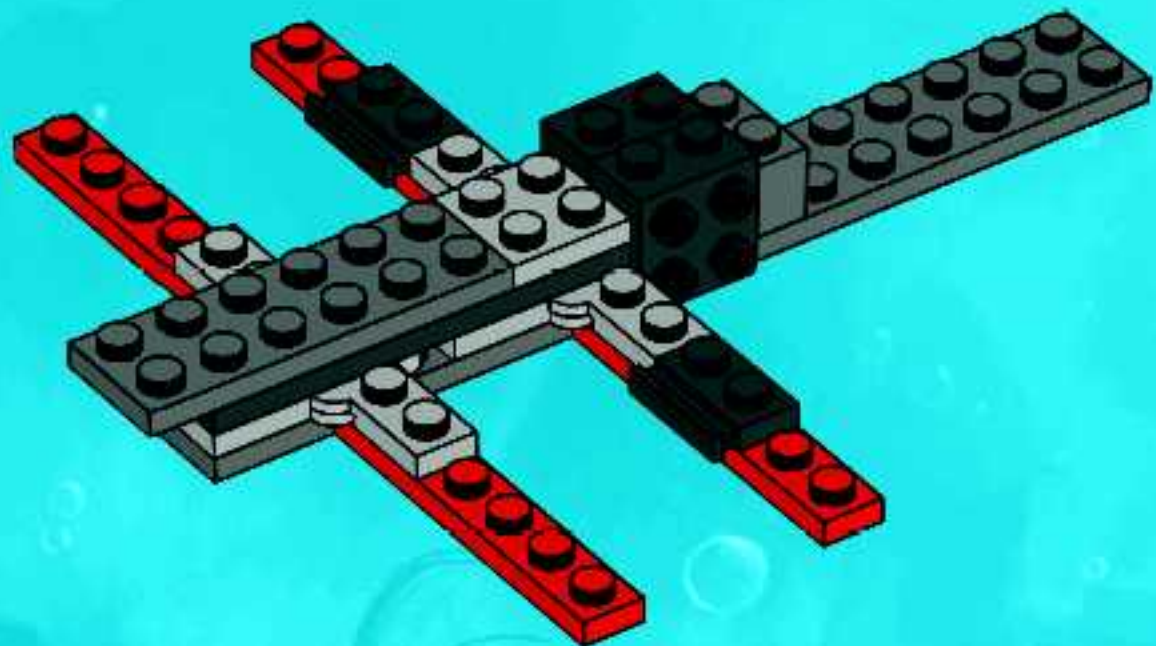

2x

9

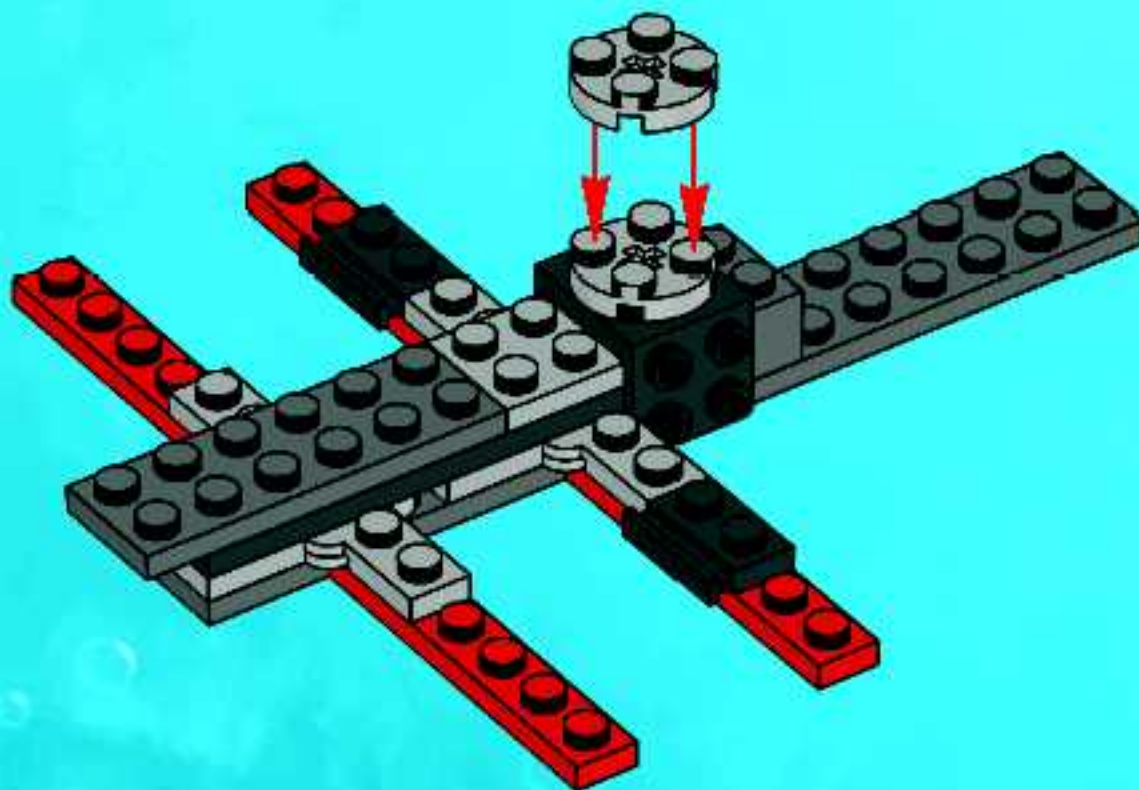

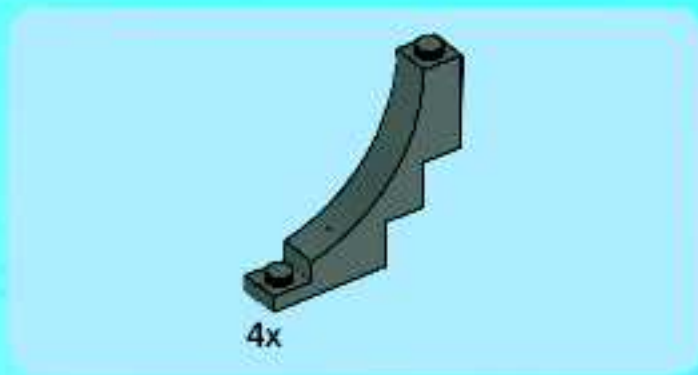

10

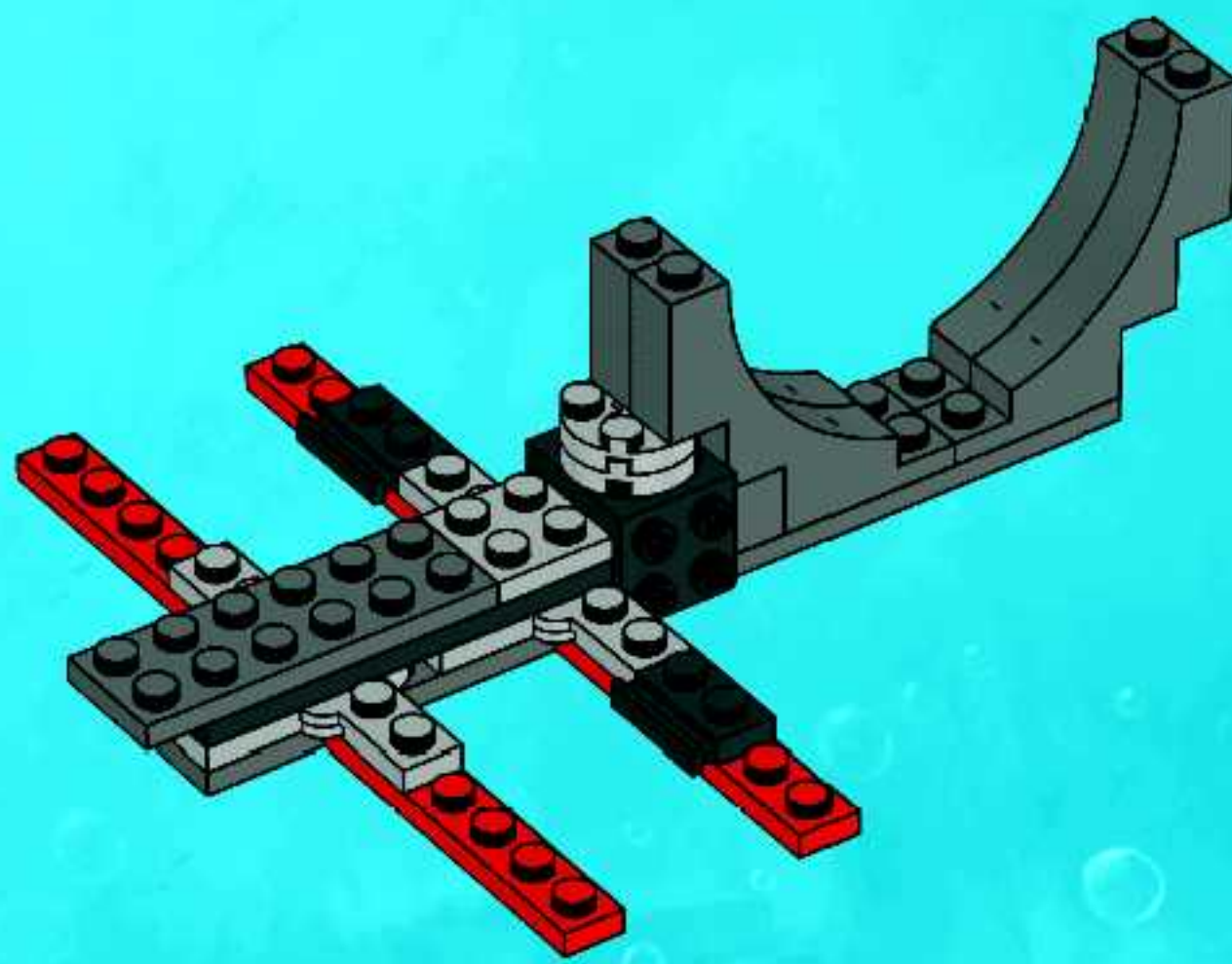

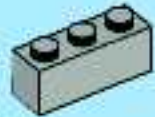
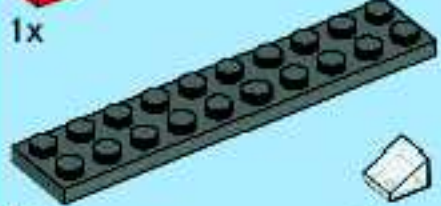
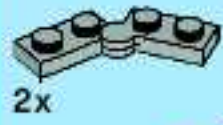

11

1



2

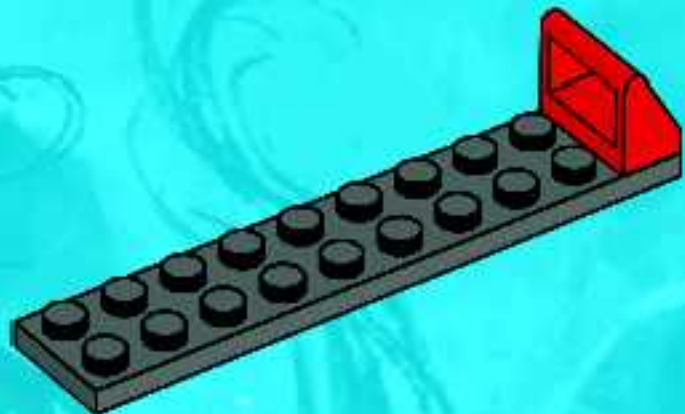

3

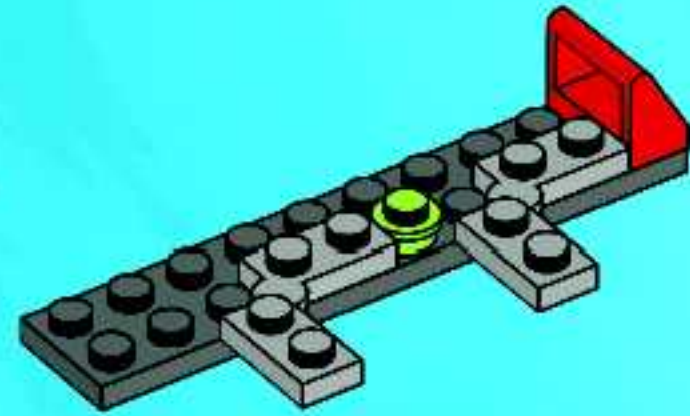

4

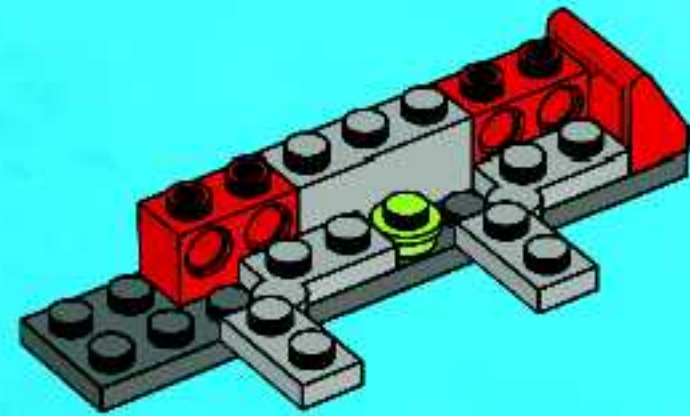

5

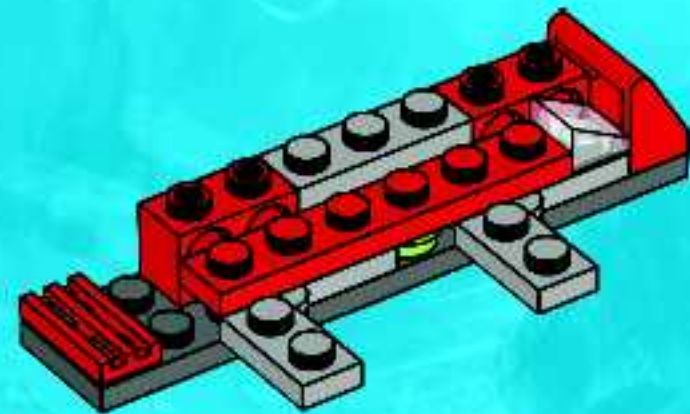



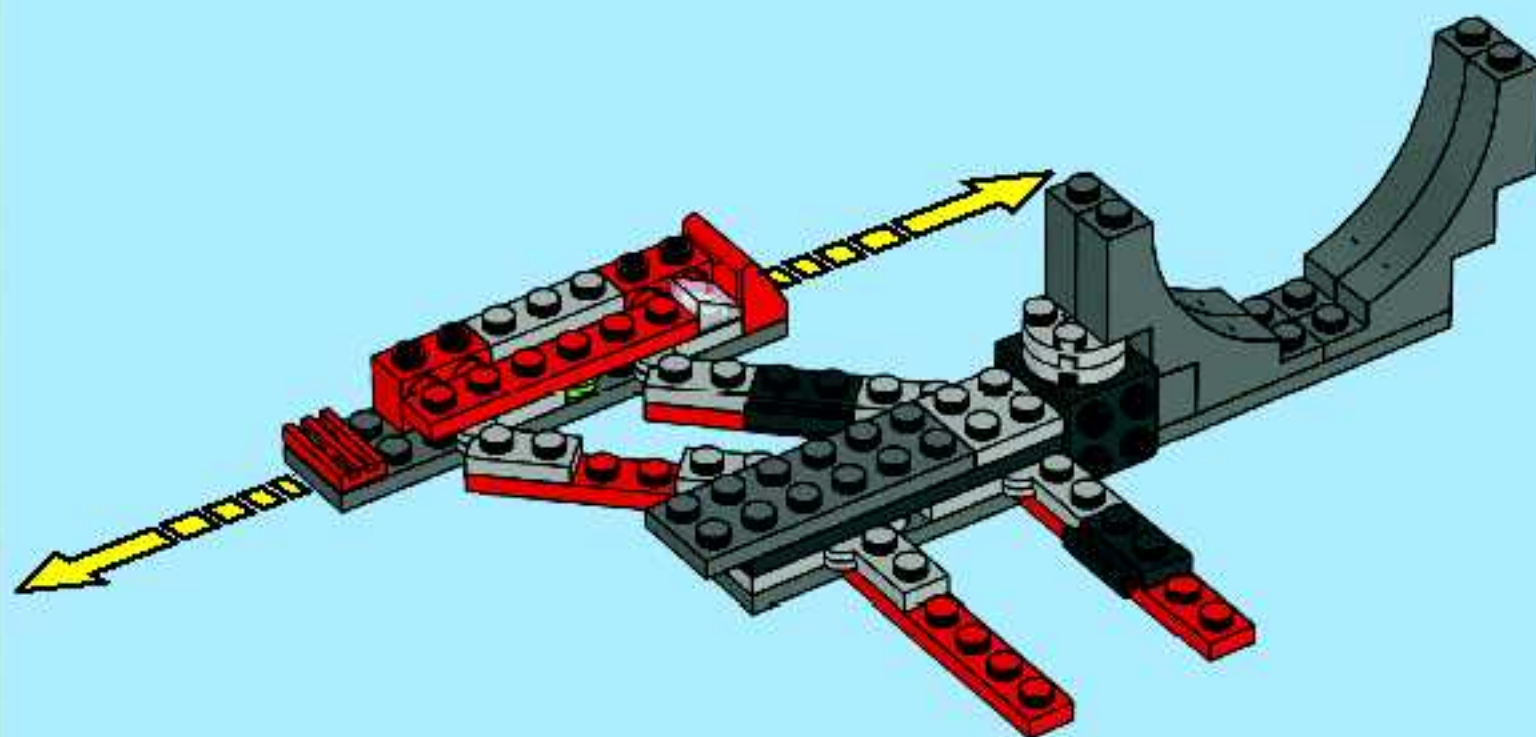
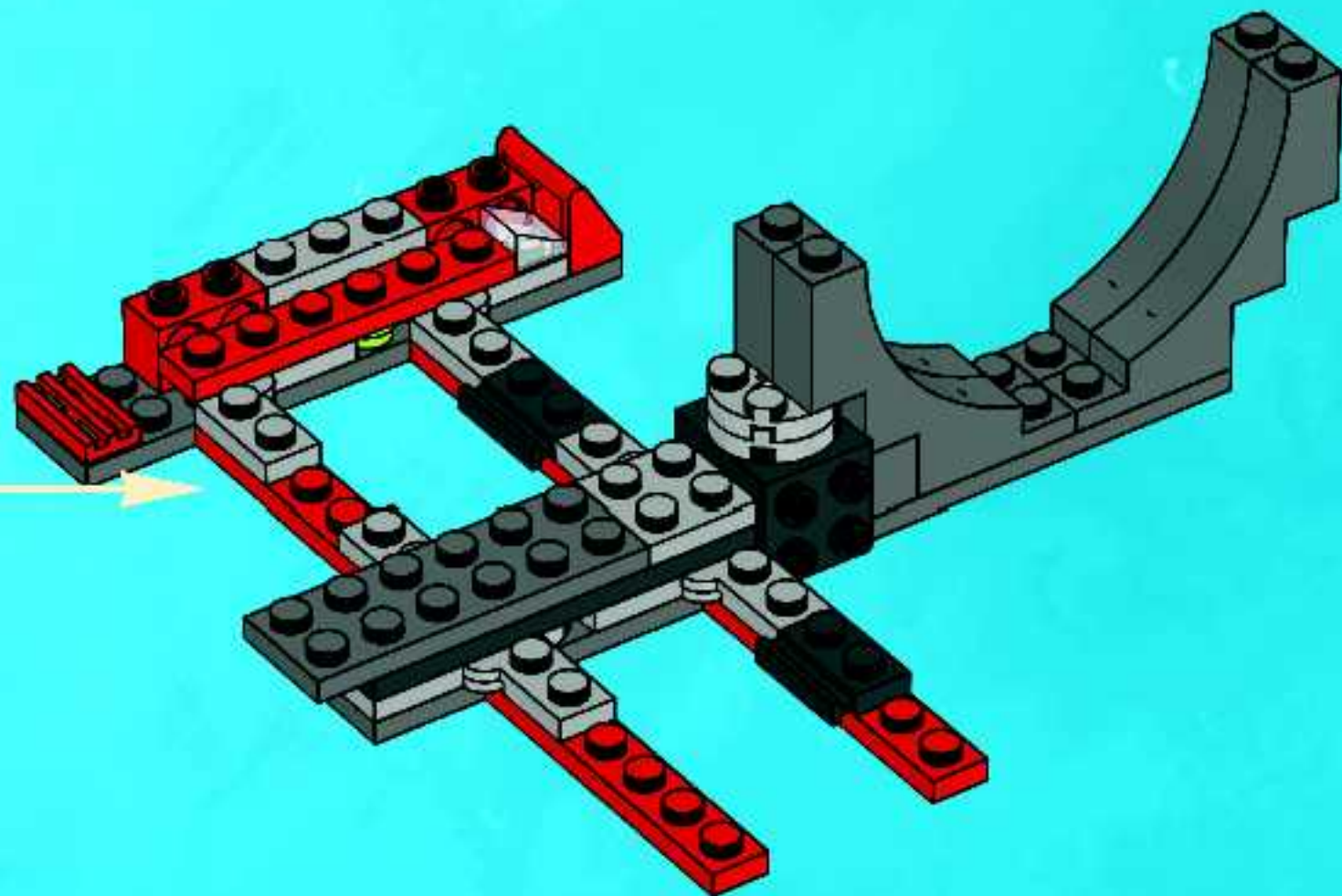

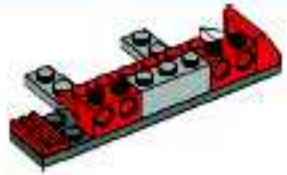

2x



1x



2x



1x



1x



1x

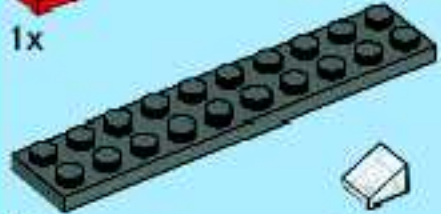

1x



1x



1x

# 12

## 1

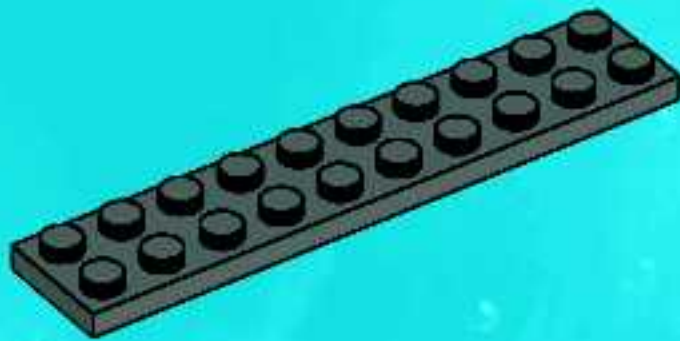

## 2

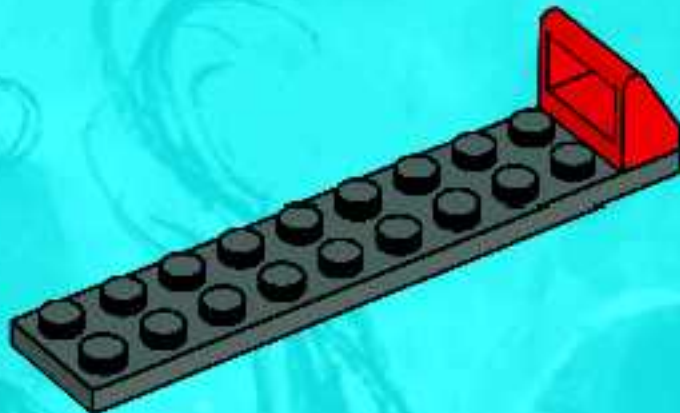

## 3

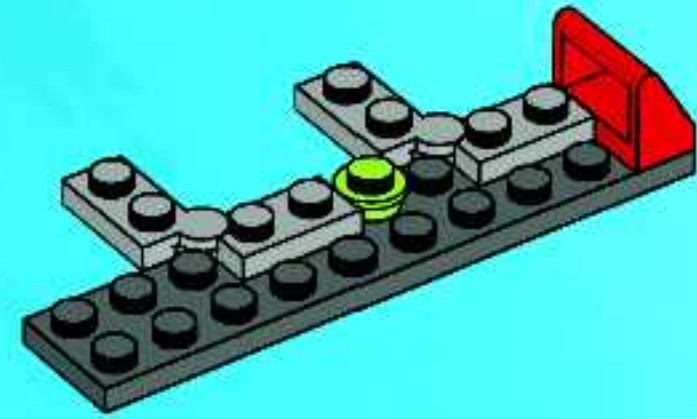

## 4

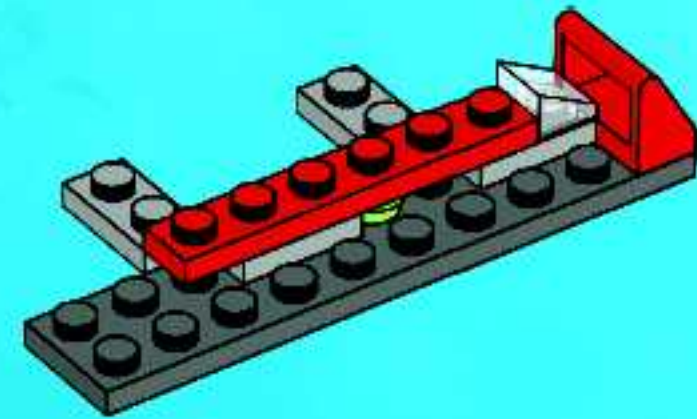

## 5

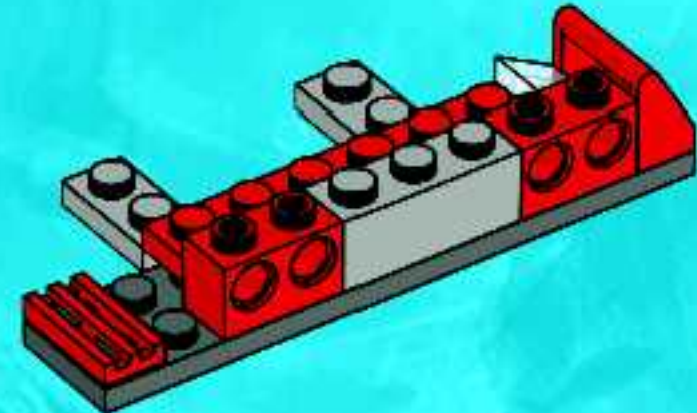

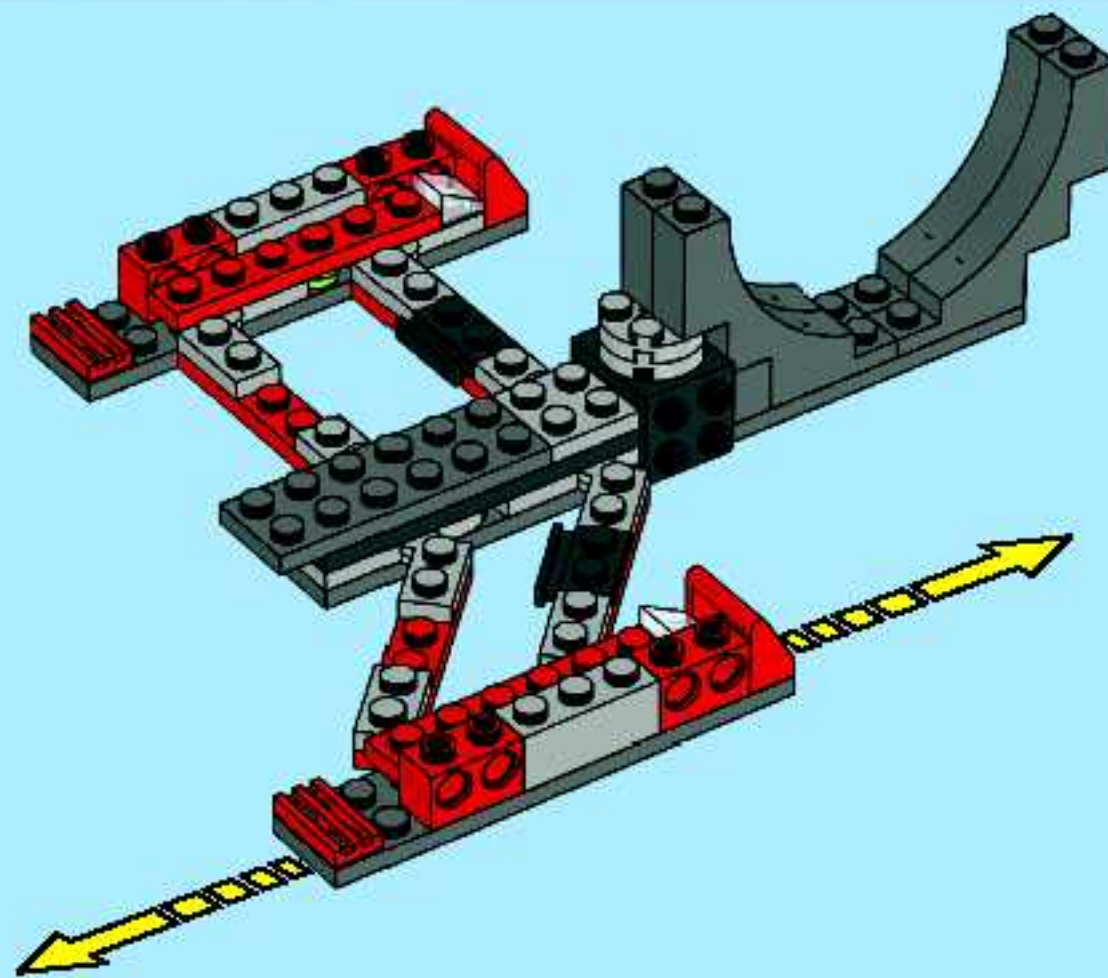
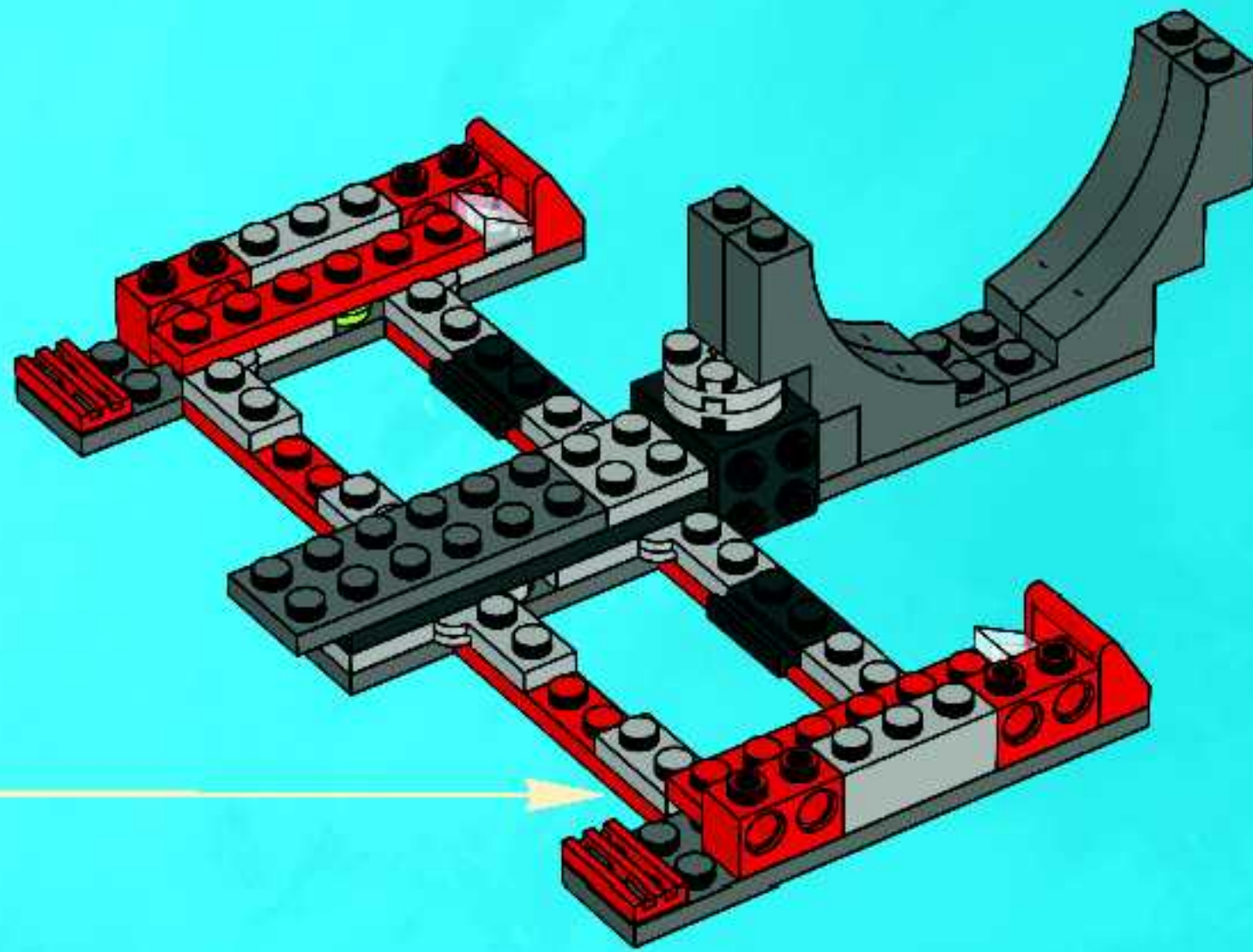



4x

# 13

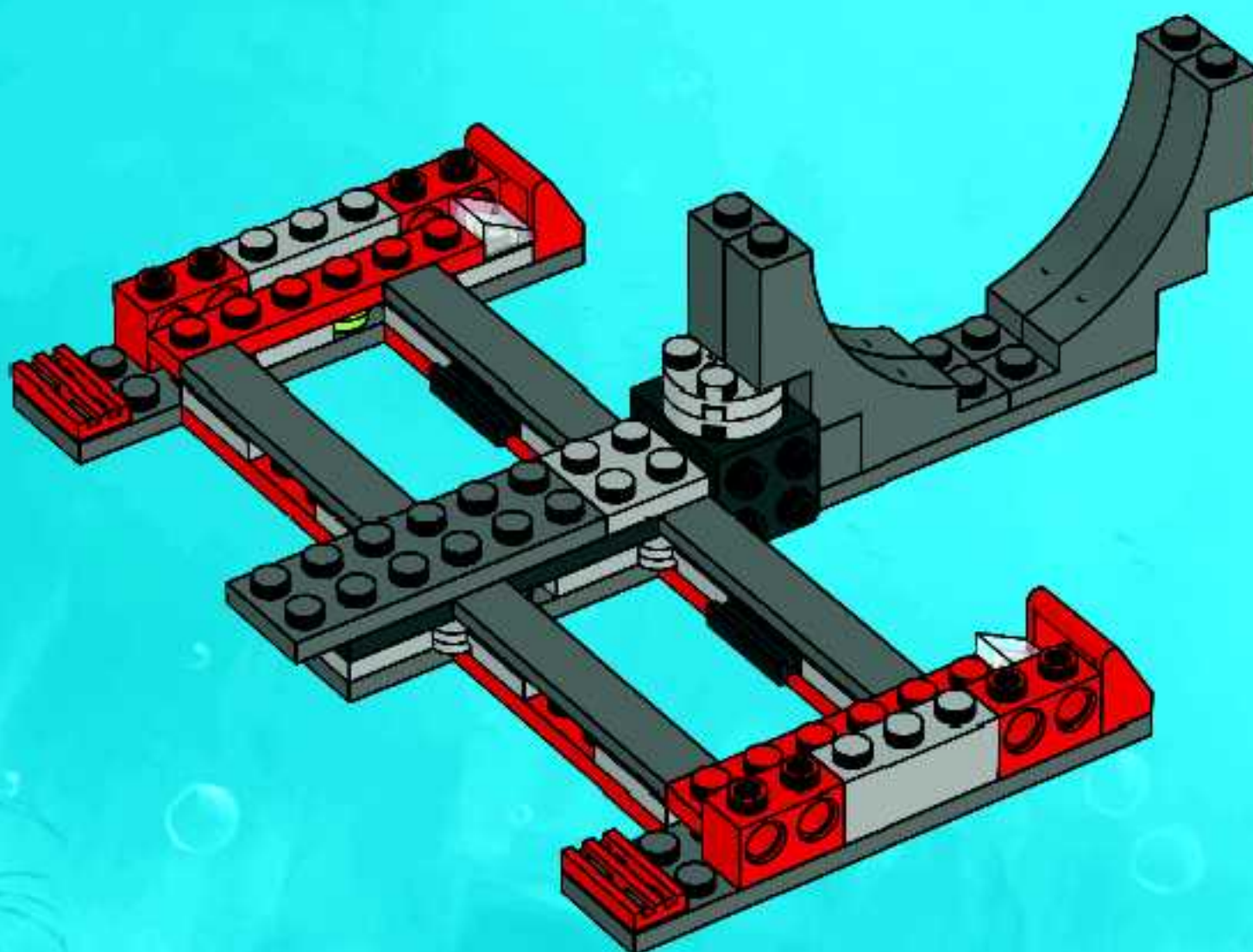



1x



1x

14

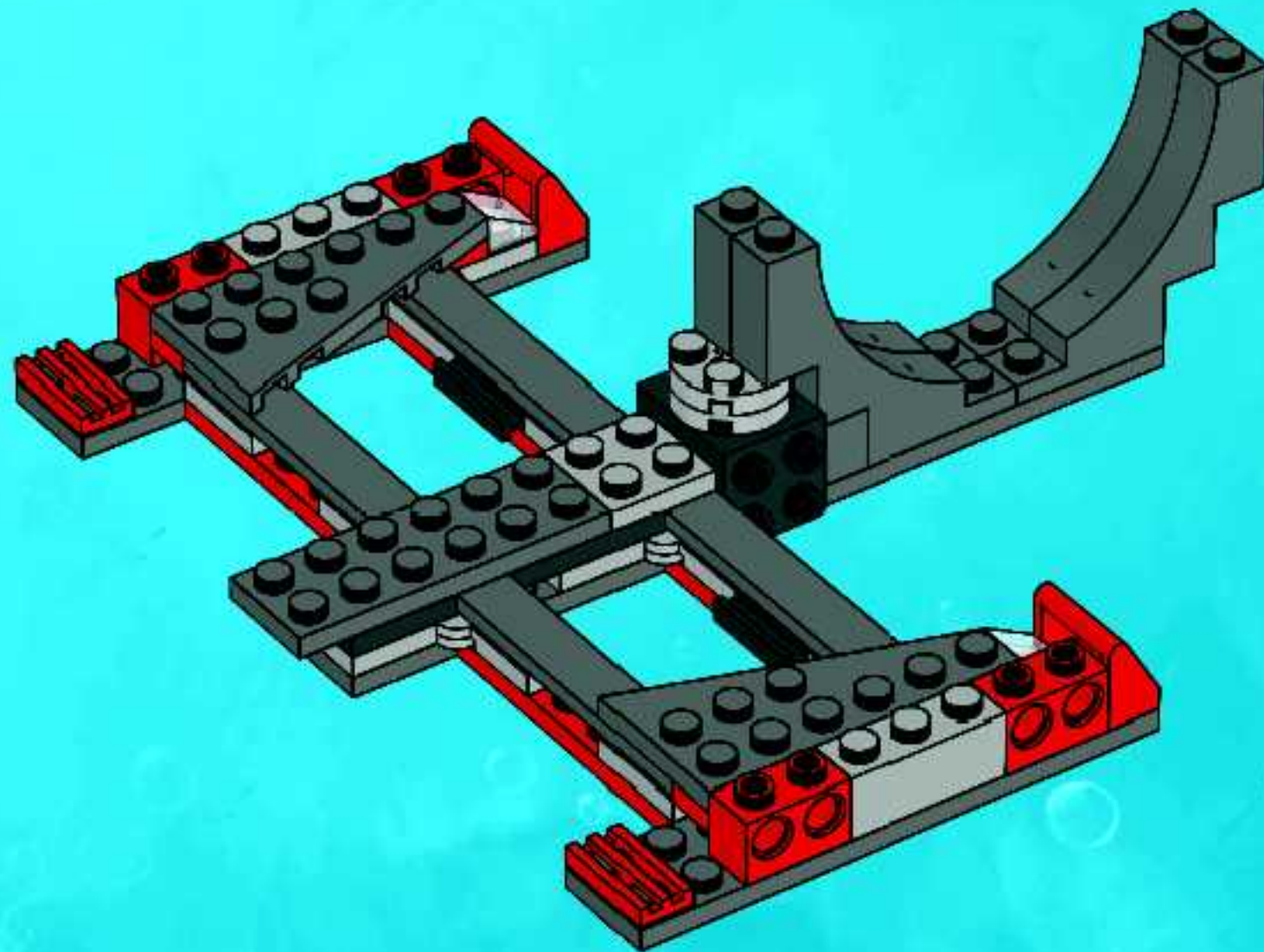

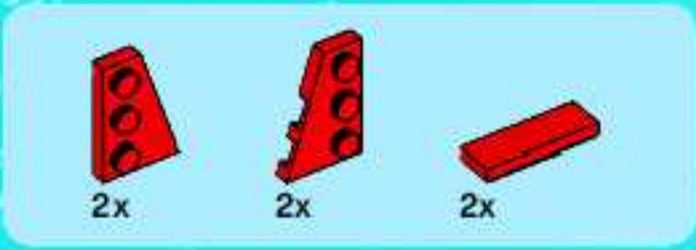

15

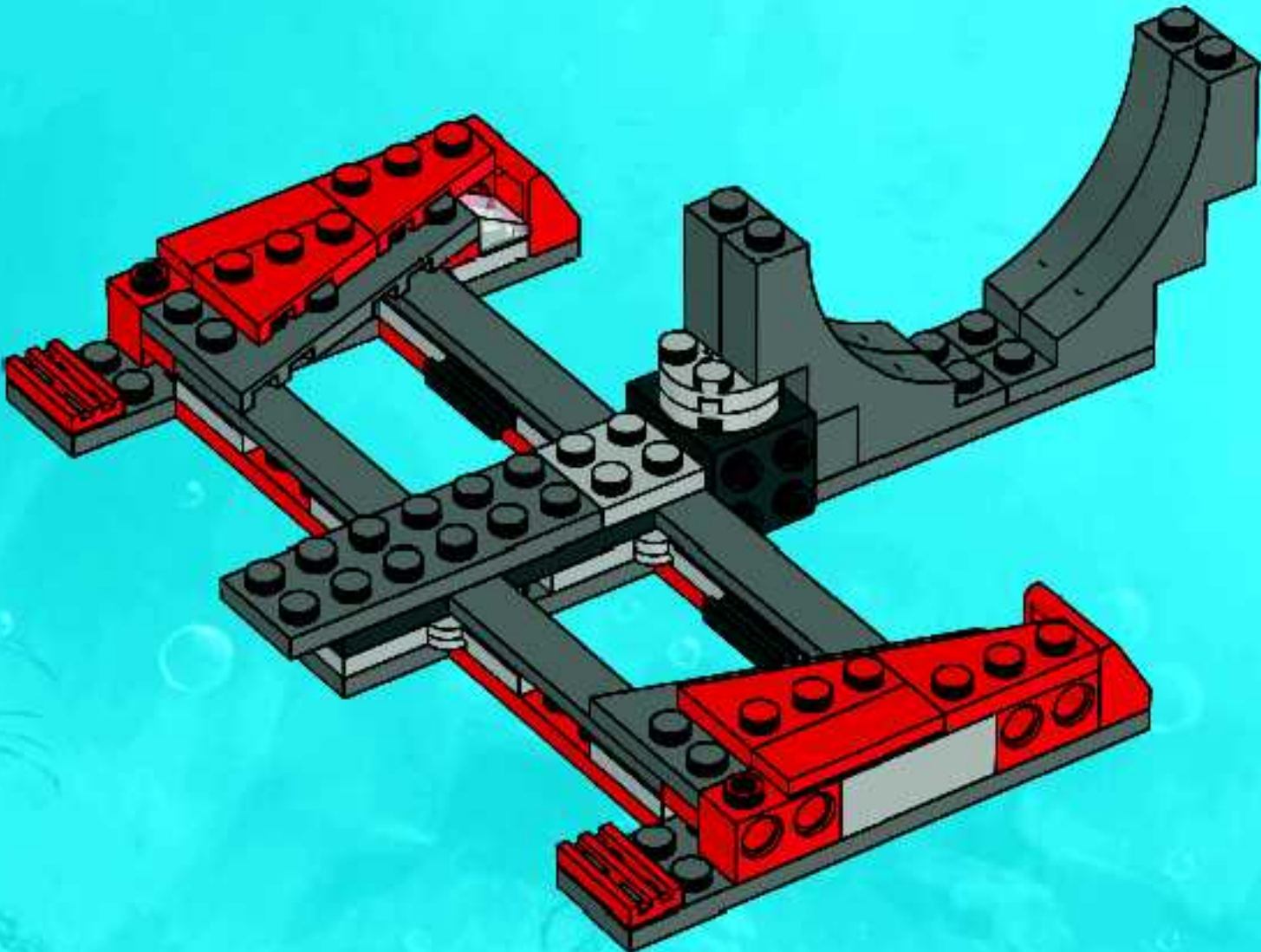

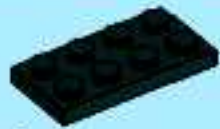

2x



4x



4x

# 16

1



2



3



4

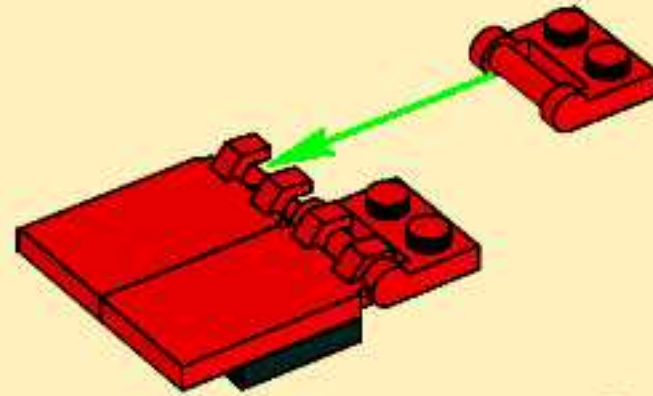

2x

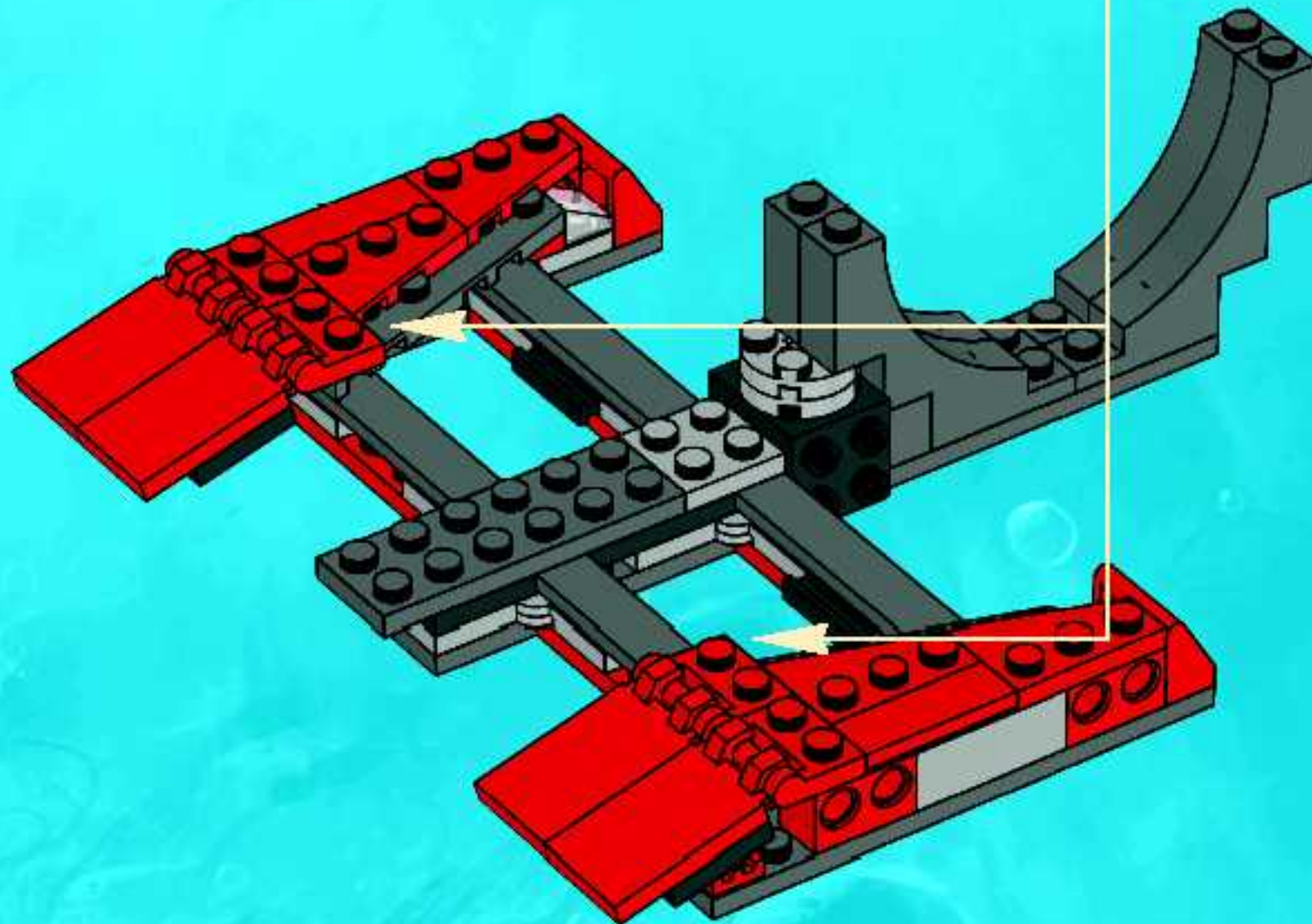



2x



2x



1x

# 17

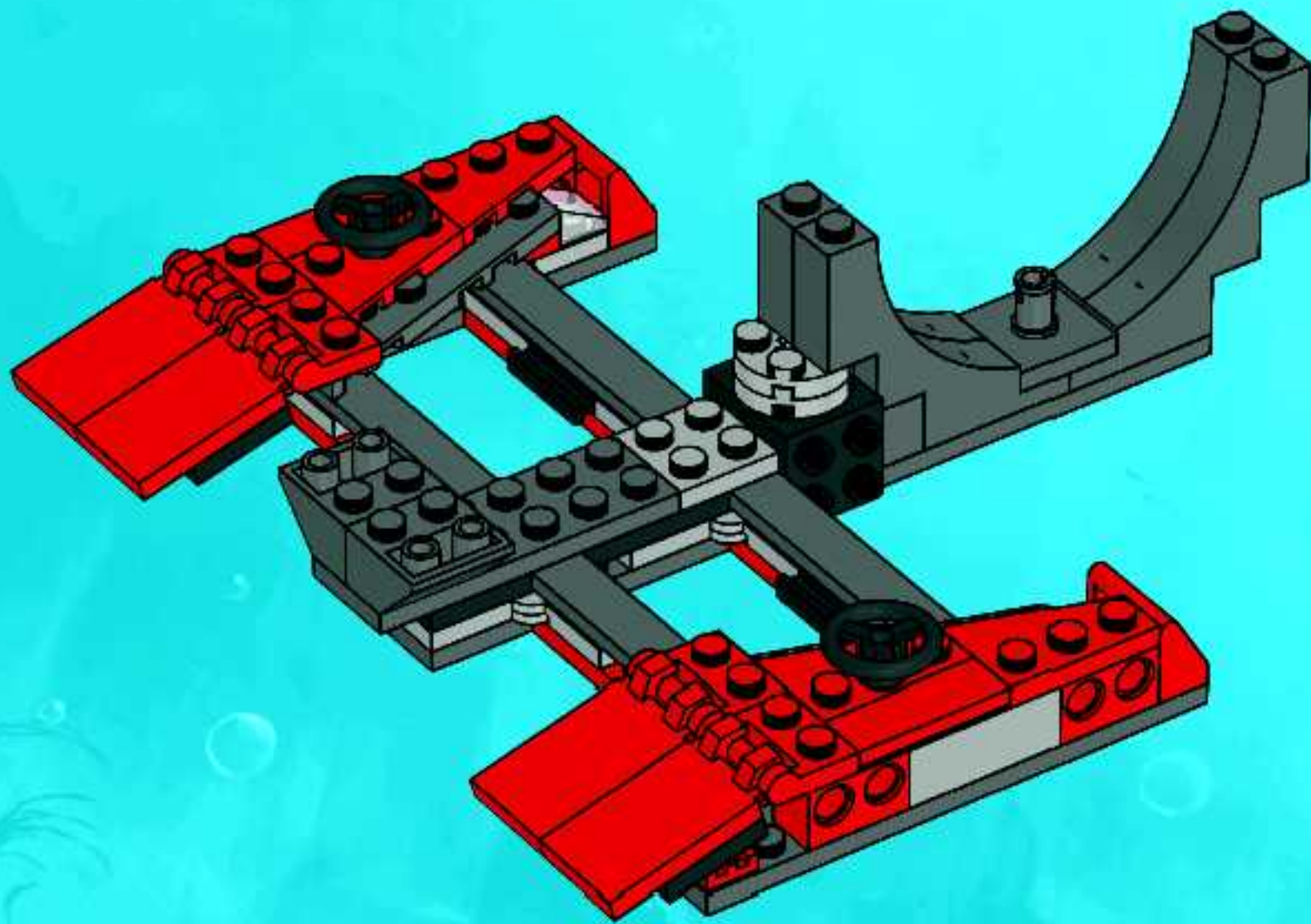





1x



1x



2x



1x

# 18

1



2

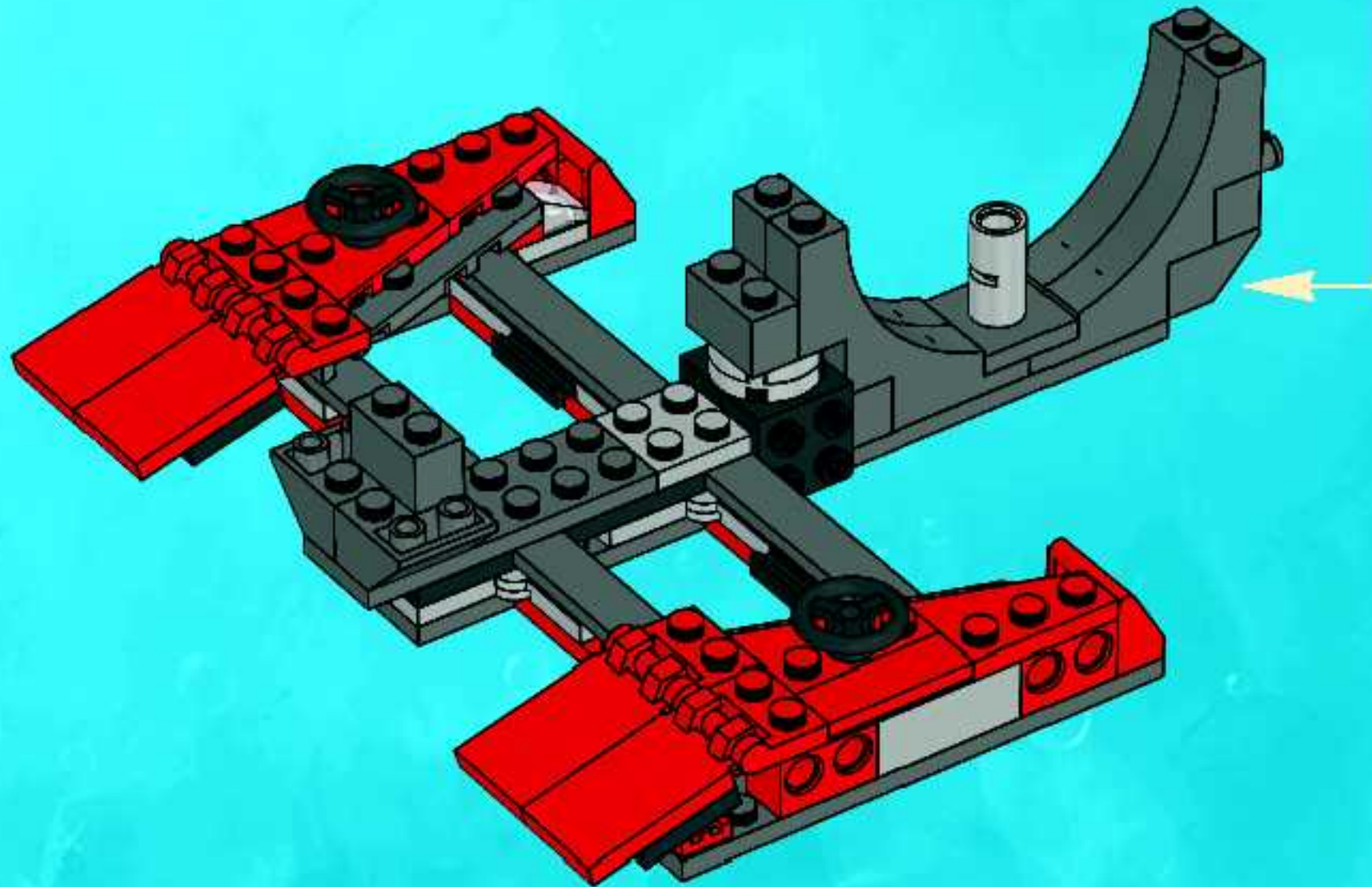

2x

2x

1x

# 19

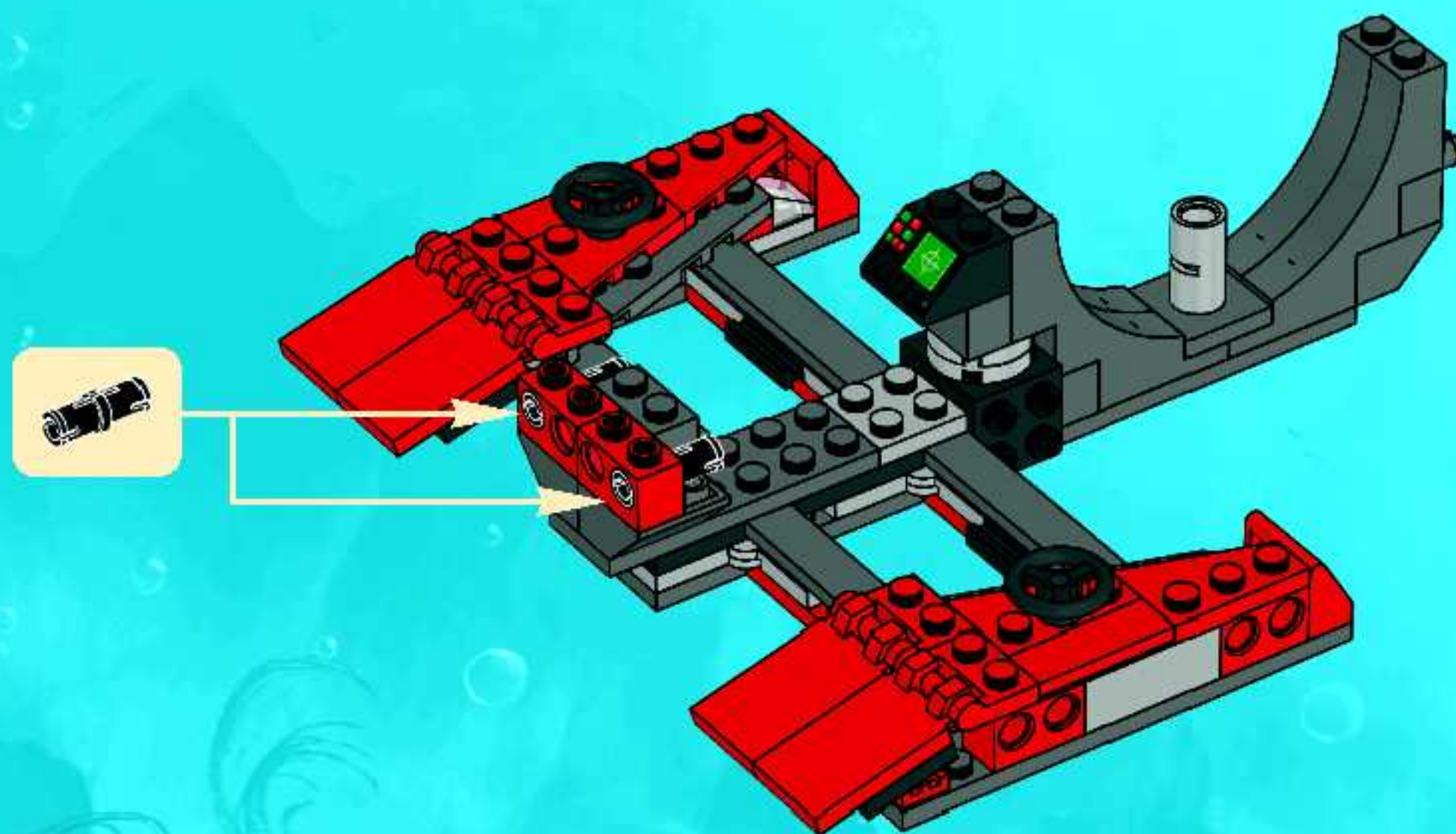

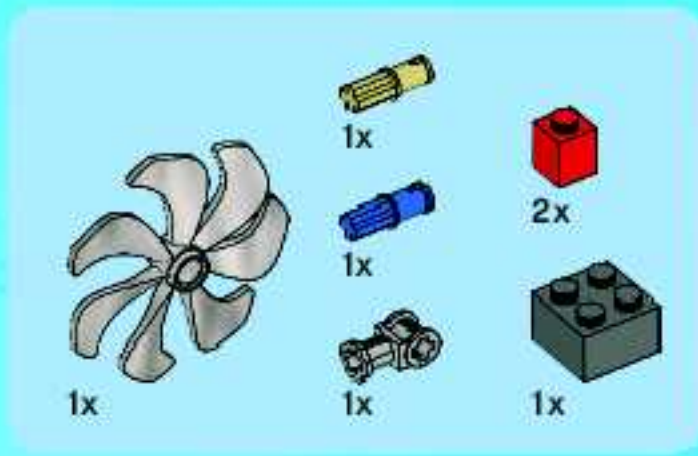

20

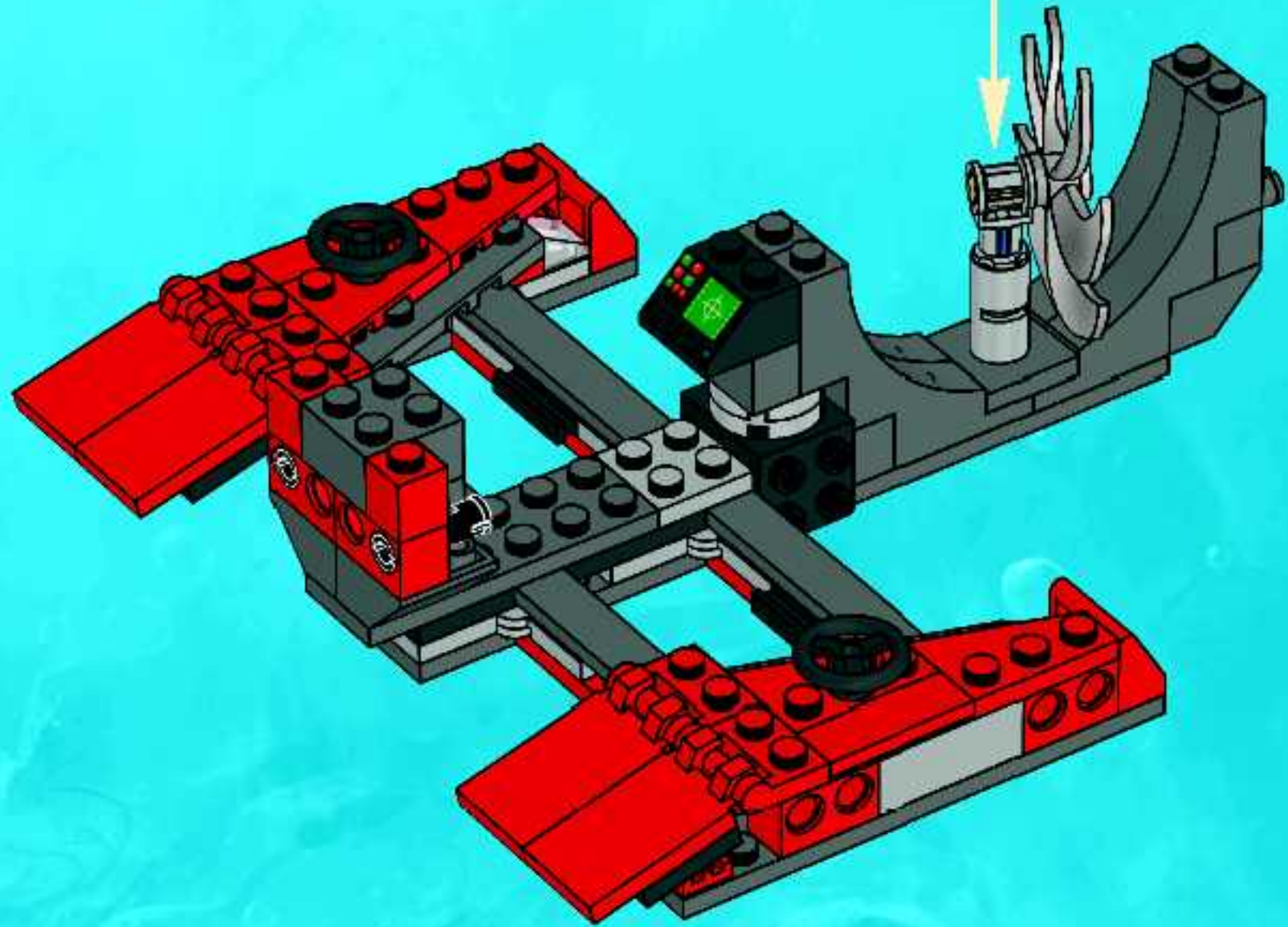
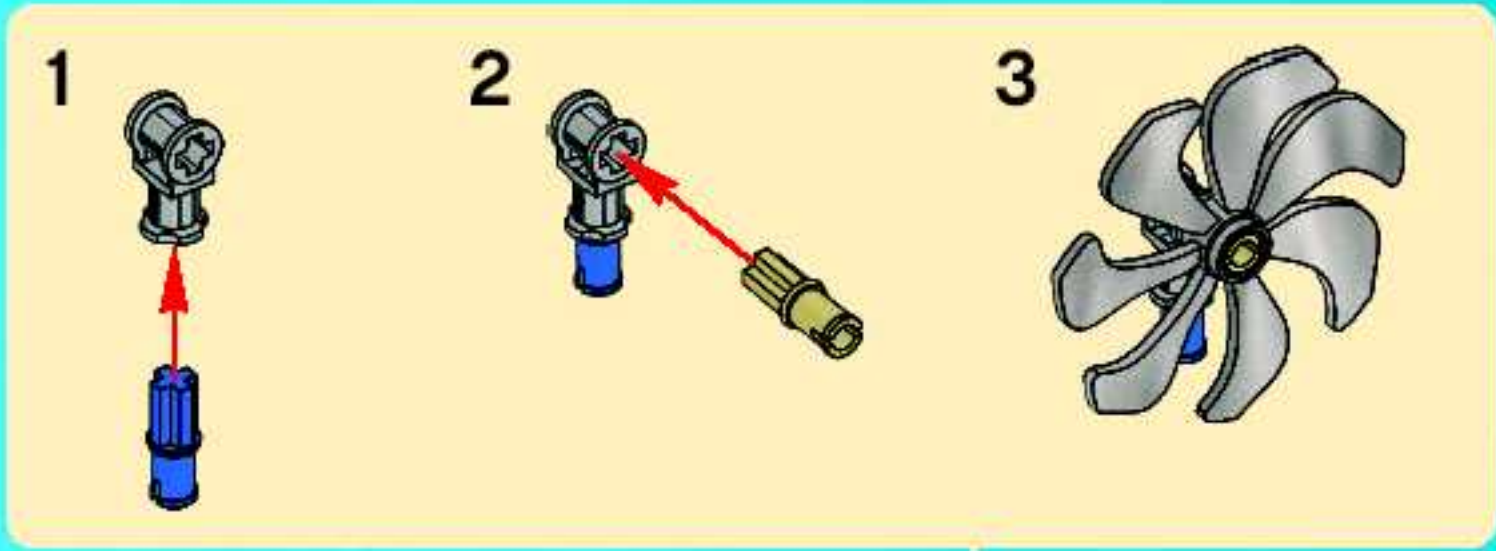

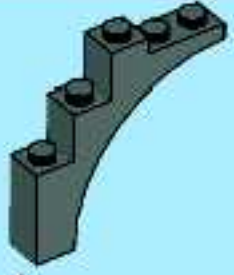

4x

21

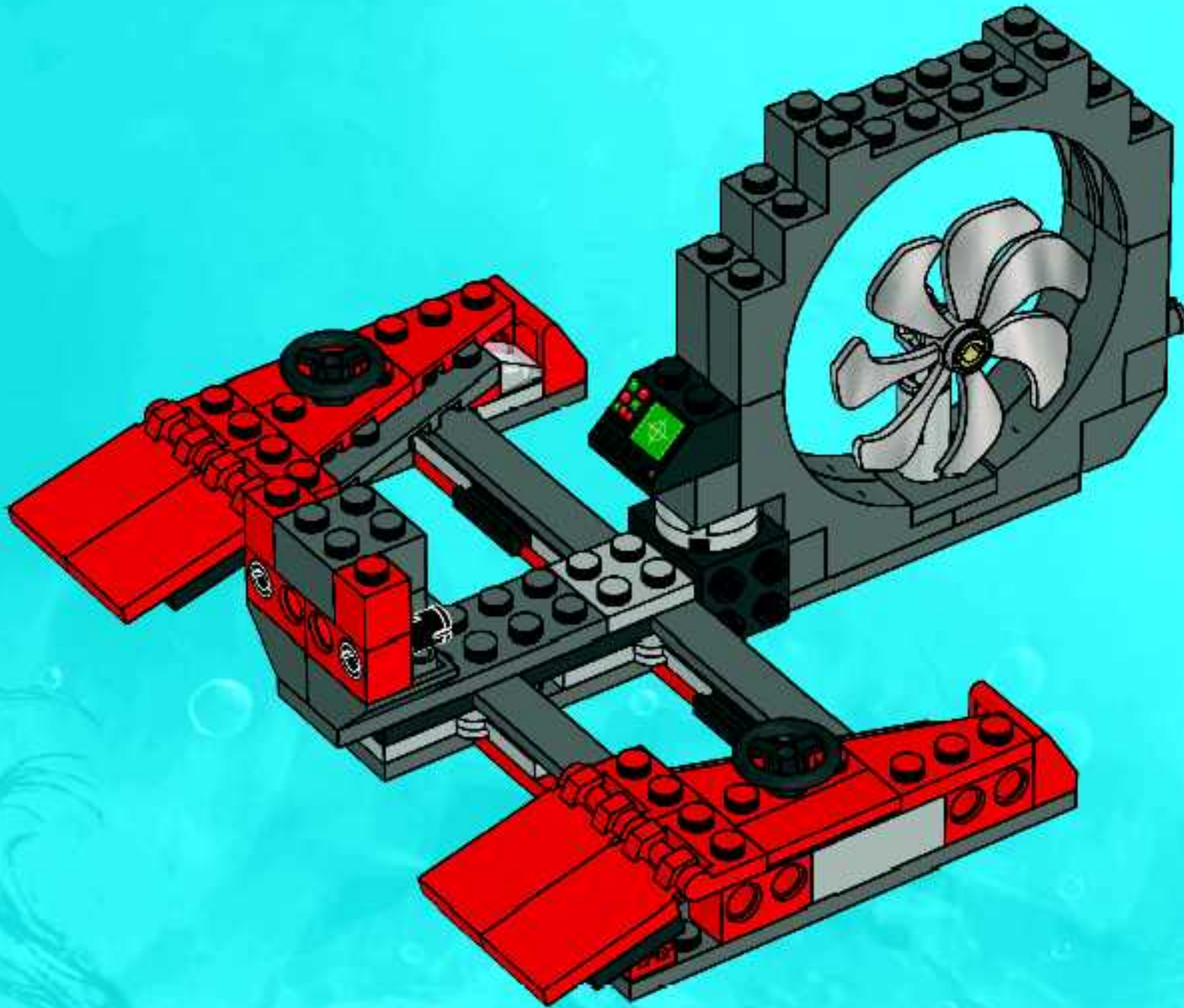

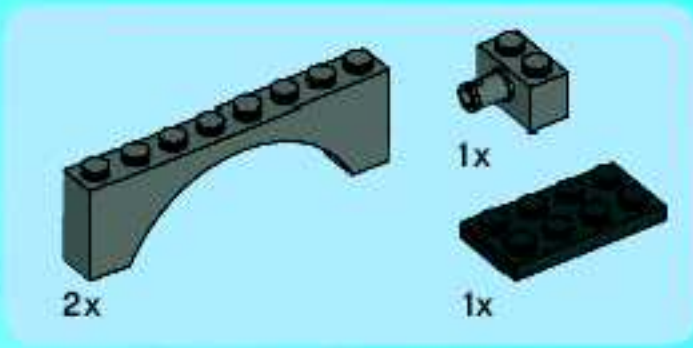

22

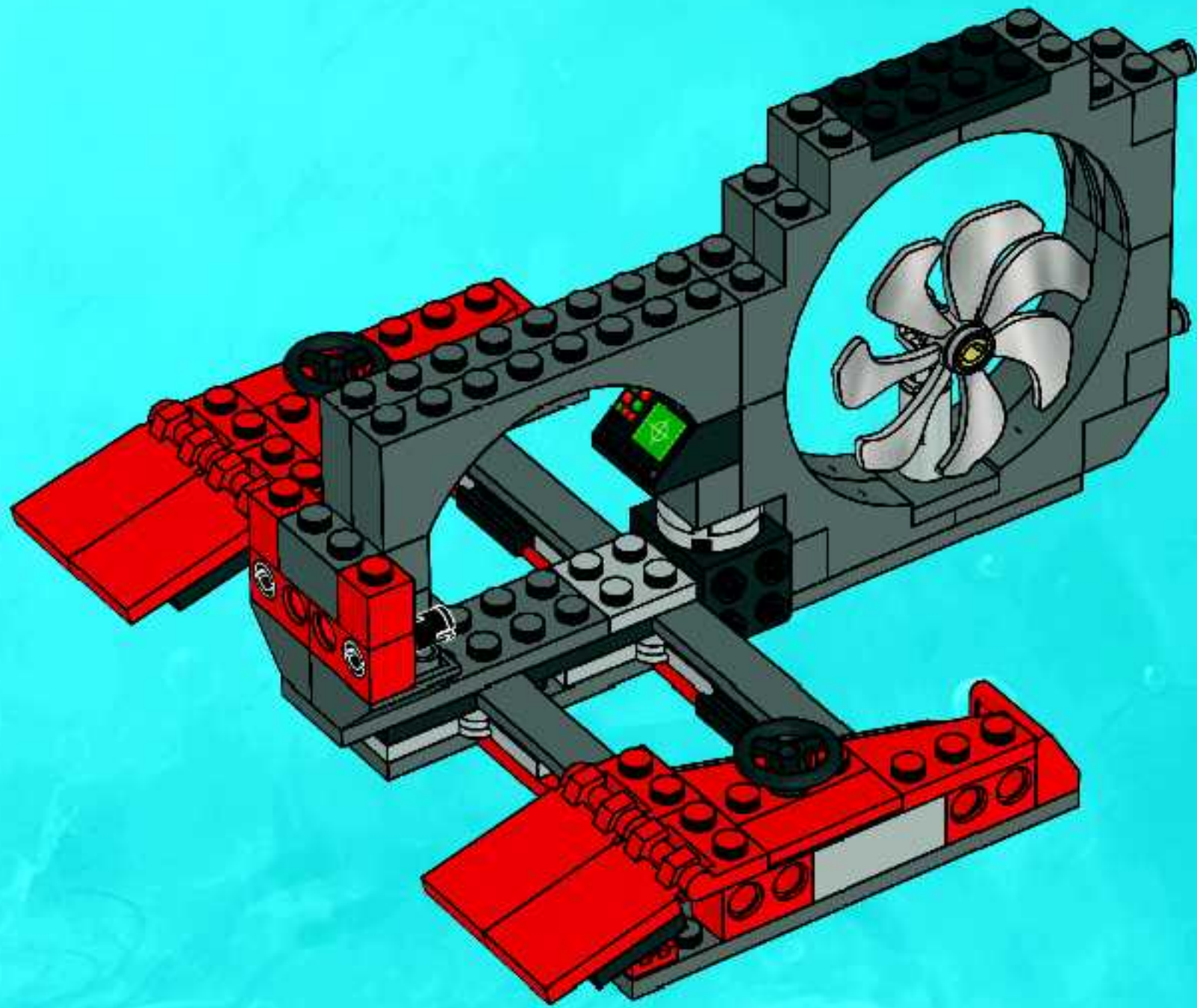

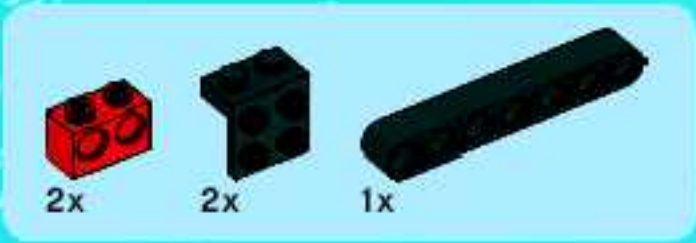

23

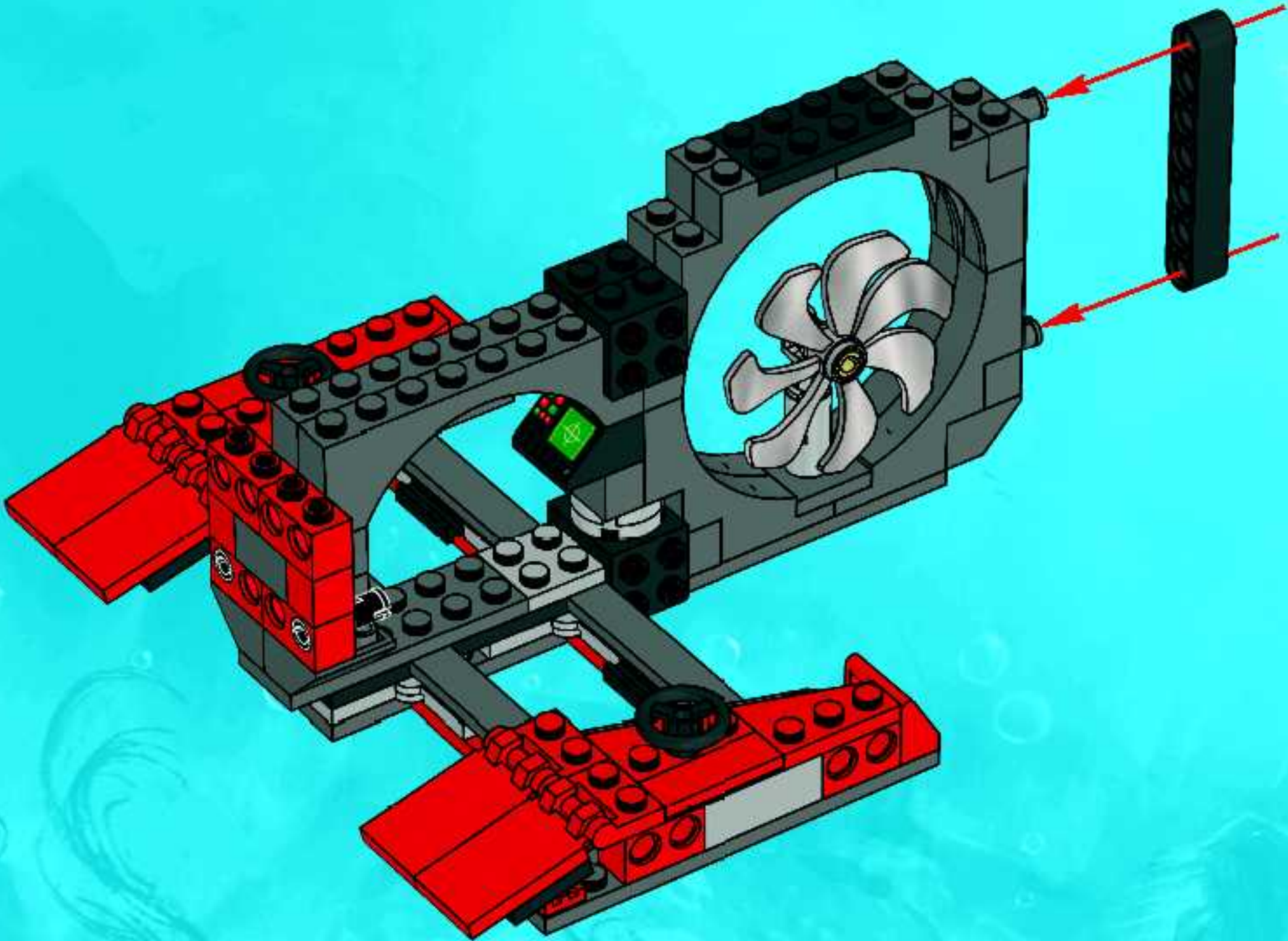



1x



2x

# 24

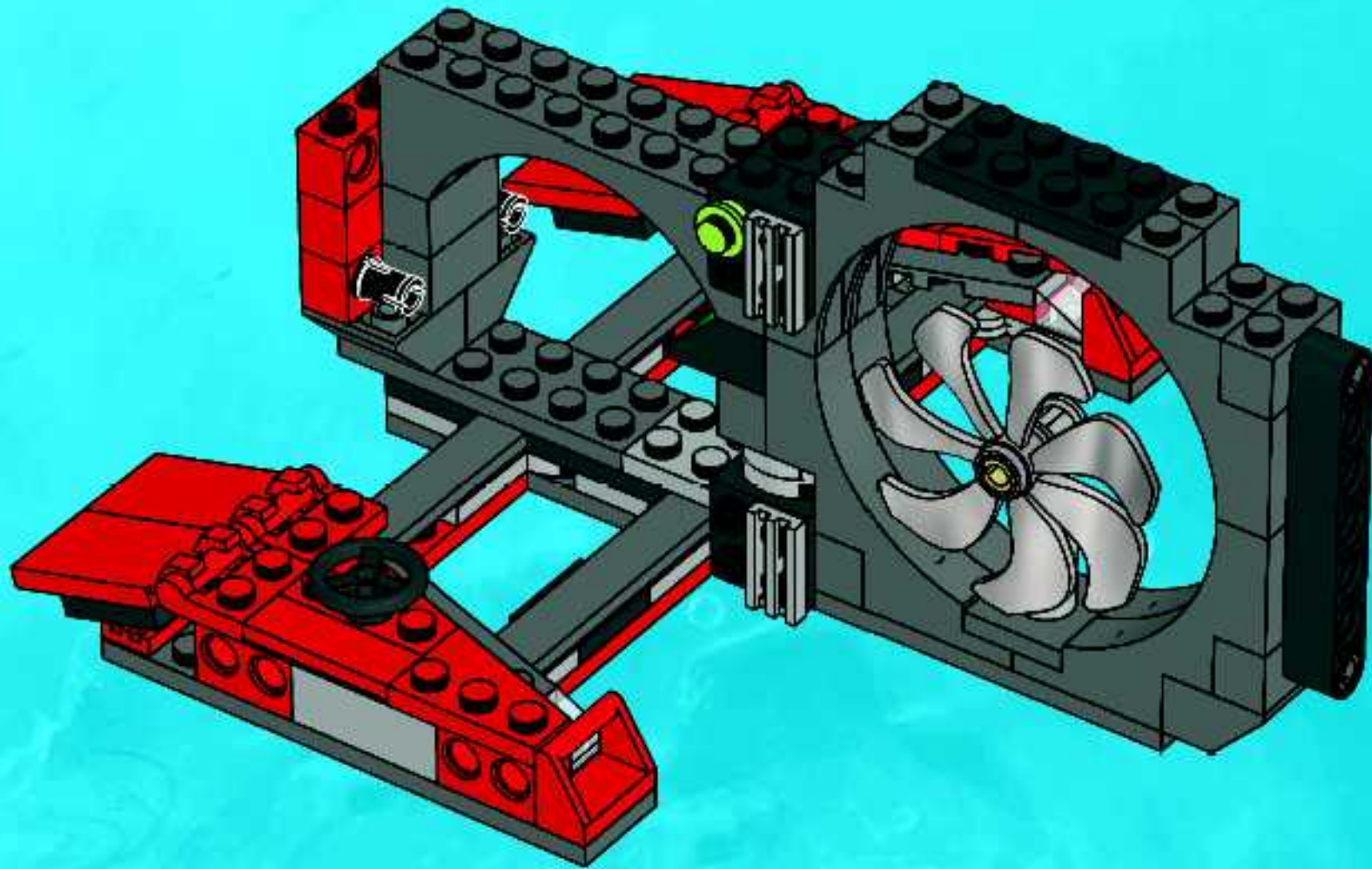



1x



2x

# 25

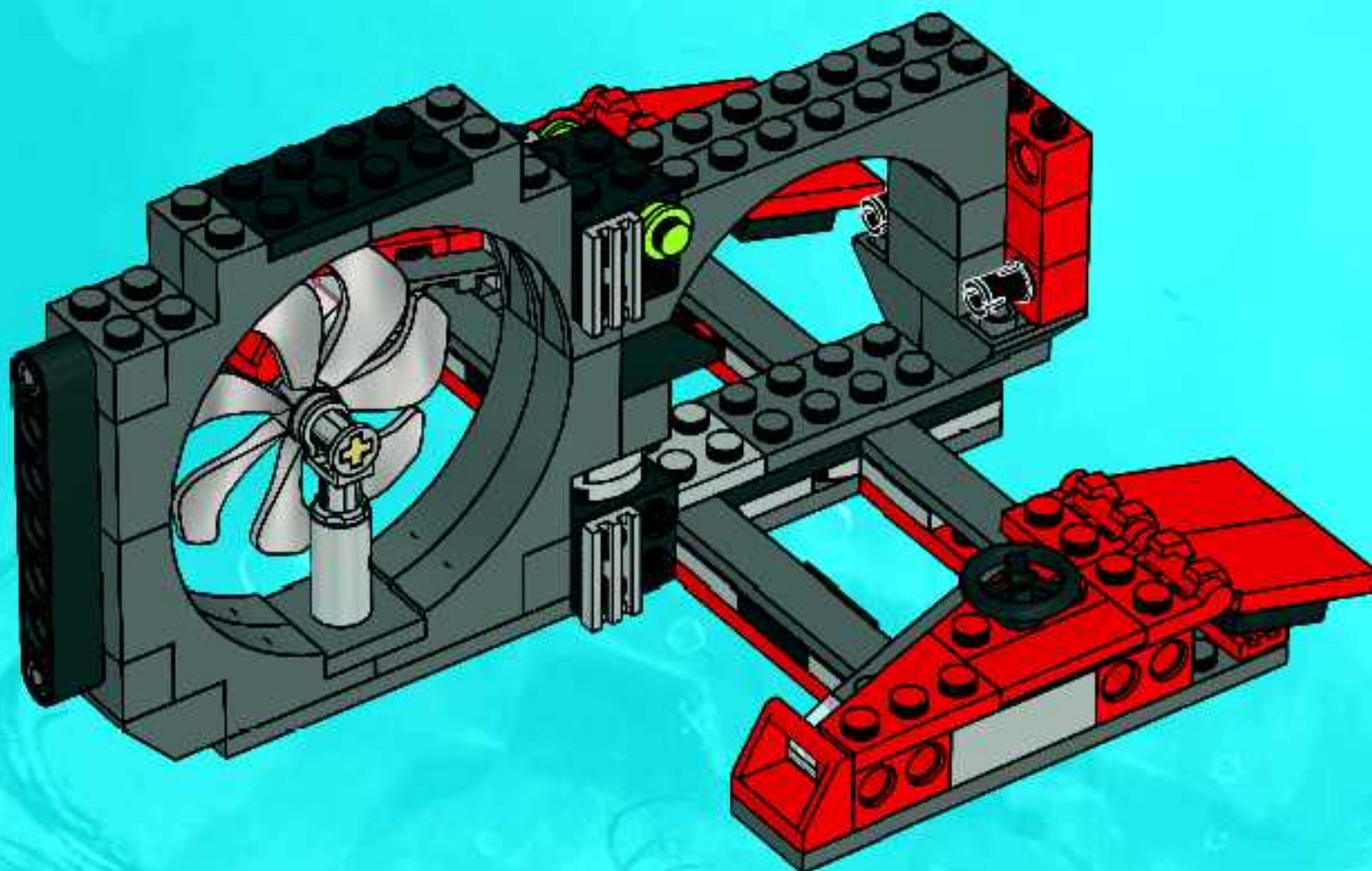



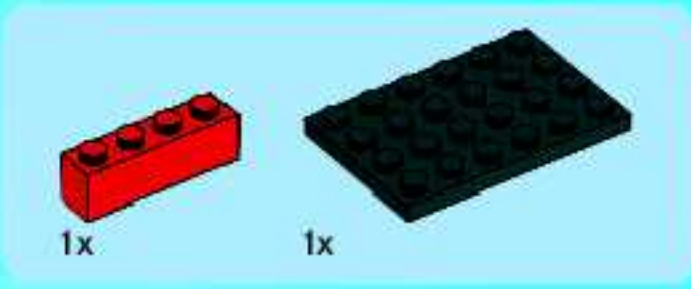

26

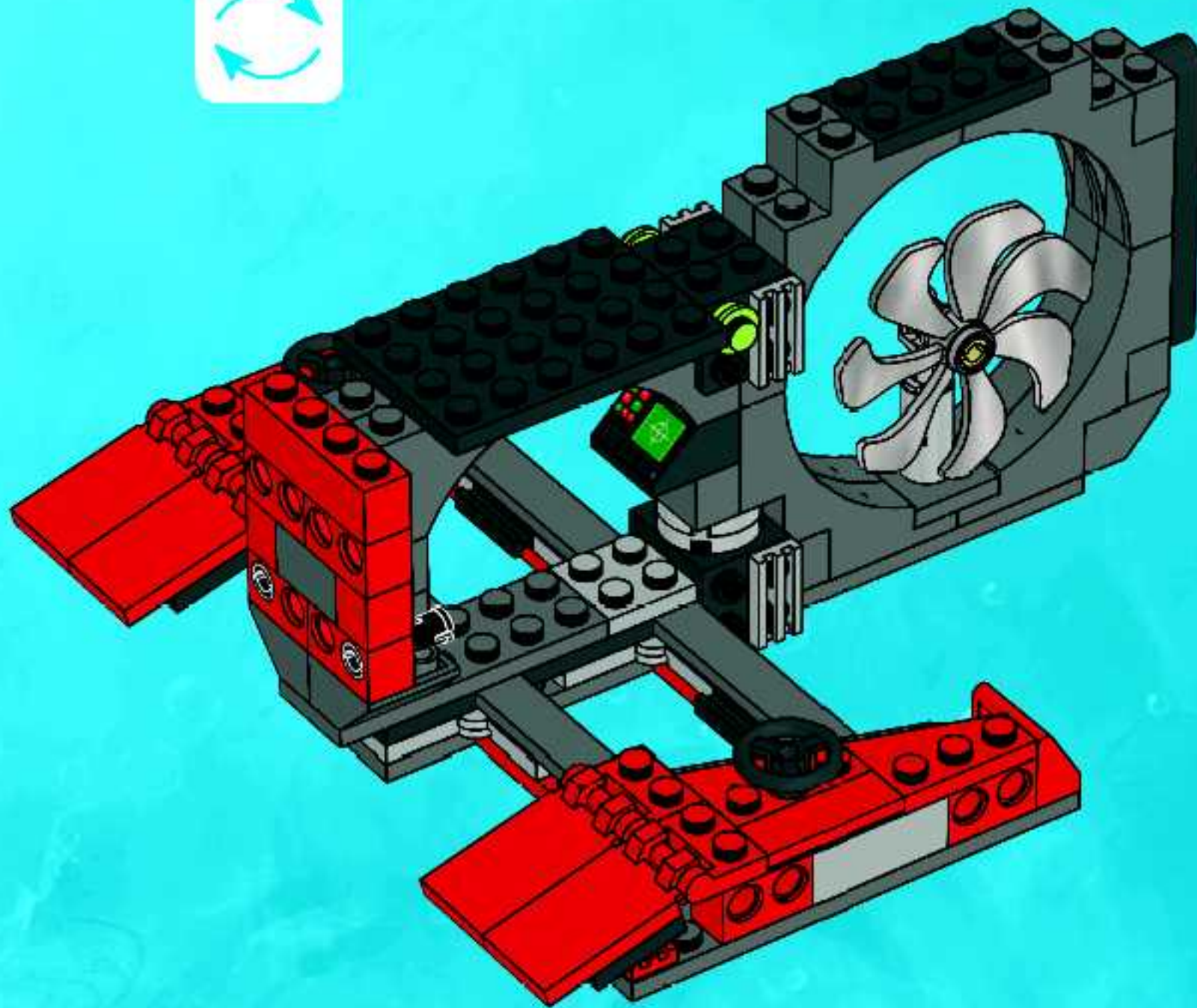



4x



1x

# 27

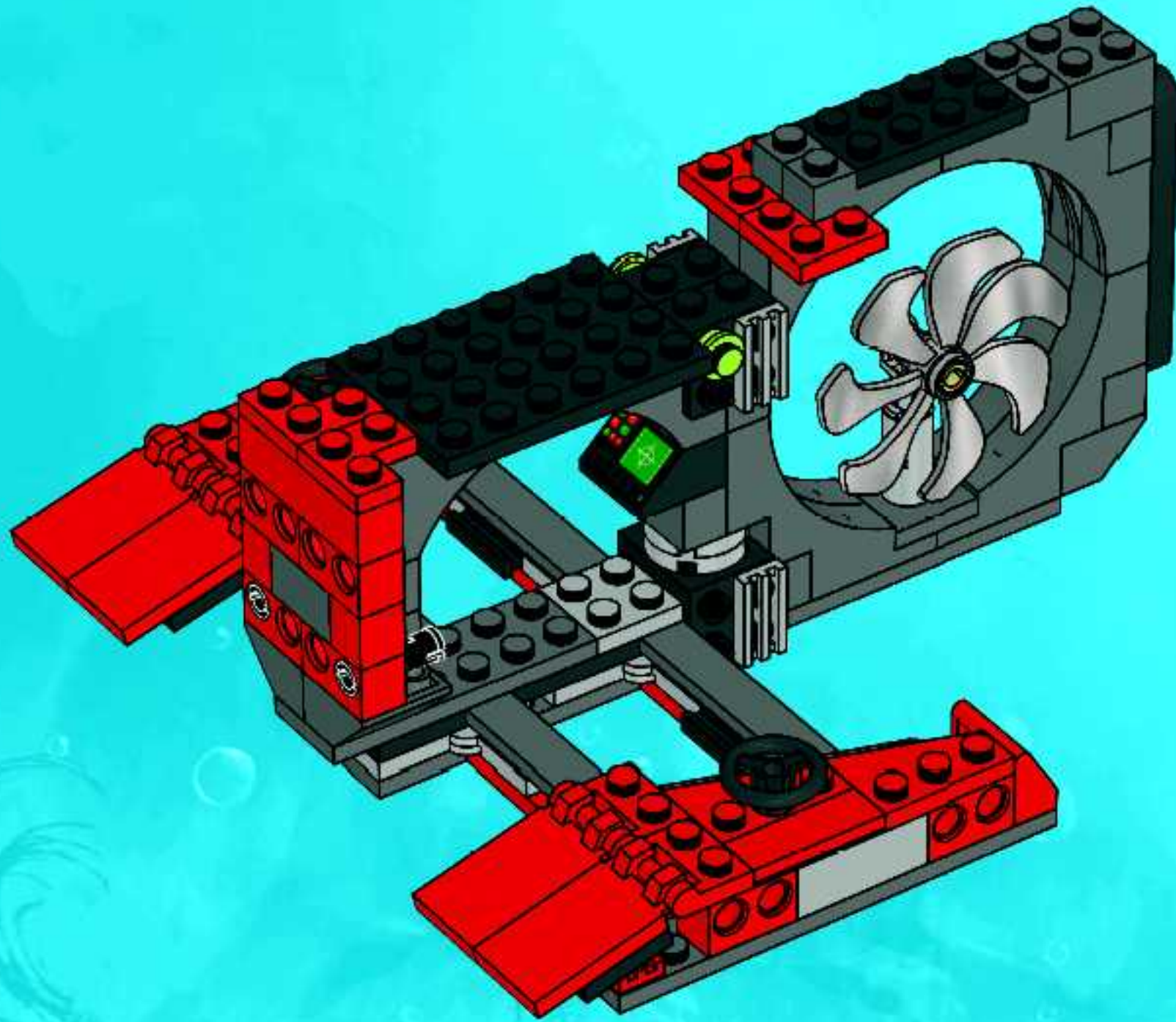



1x



2x

# 28

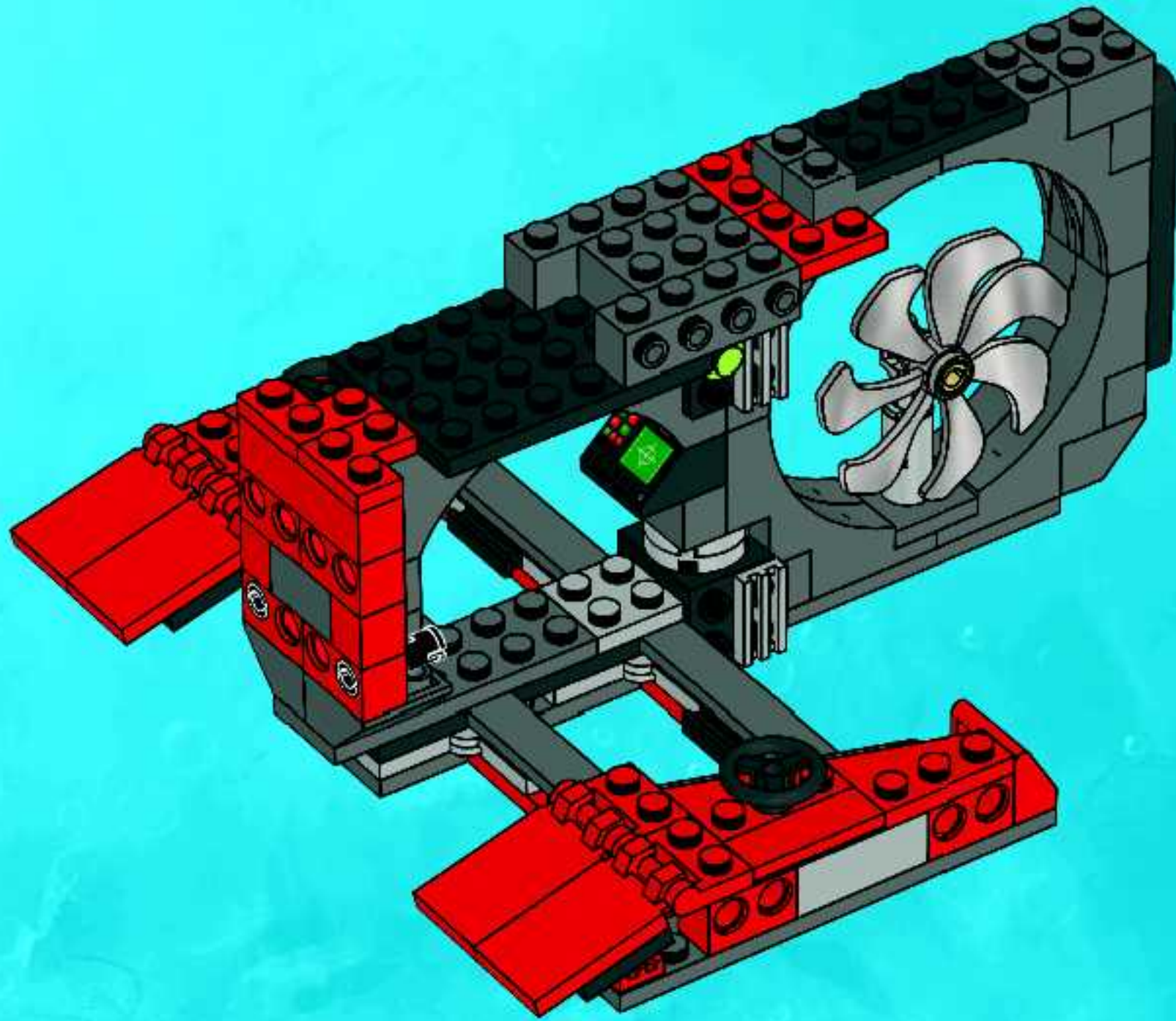



2x



1x



2x

# 29

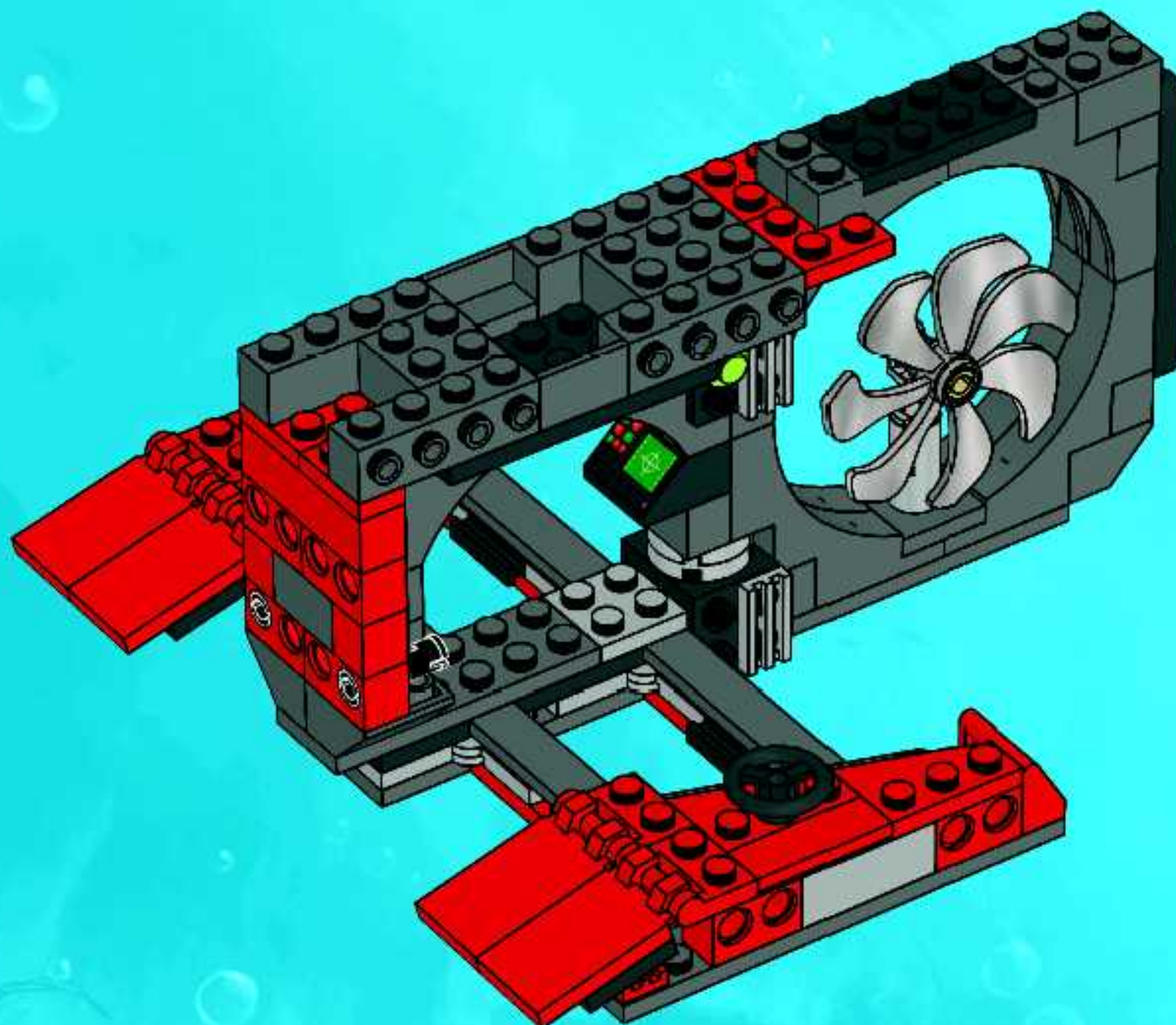



1x



1x



1x

# 30

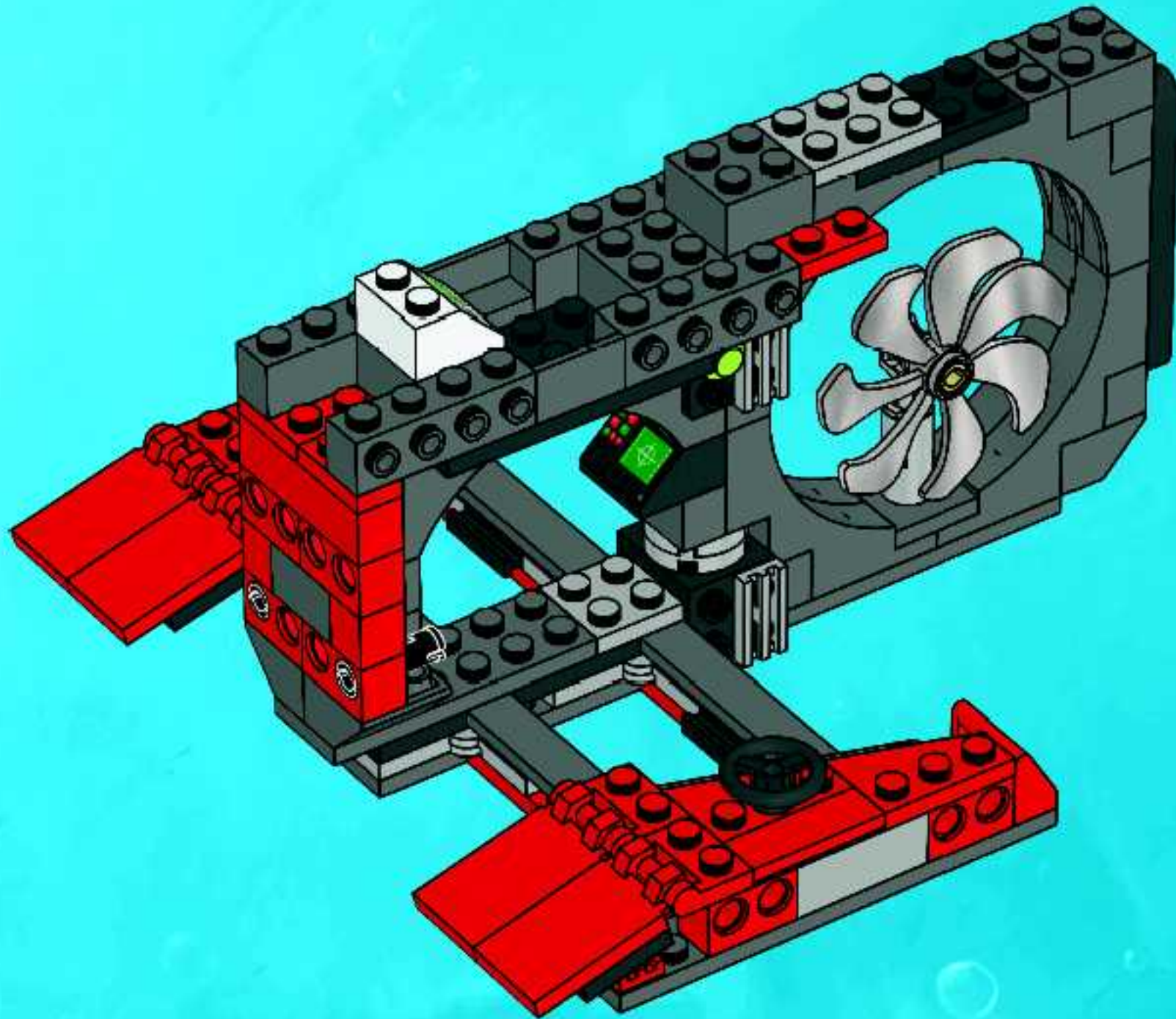

**FREE! GRATIS! GRATUIT!**



**www.LEGOclub.com**



**00800 5346 5555\***        

  **1-866-534-6258 • 1-877-518-5346**

US & Canada only

Canada seulement



VISIT THE WORLD'S  
BIGGEST LEGO® SHOP!

**www.LEGOshop.com**

\* FreePhone. Mobile charges may apply. \*\* Numéro sans frais. Les frais peuvent s'appliquer avec les téléphones cellulaires. \*\*\* Gebührenfrei! Kosten für Anrufe aus Mobilfunknetzen können anfallen. \*\*\*\* Grátis telefonar. Vários custos de ligação. \*\*\*\*\* Le numéro est gratuit, mais des frais peuvent s'appliquer. \*\* Debit is gratis, but du kosten kan in Postbetaal. \*\*\*\*\*



**YES! I want to join the LEGO Club FREE! OUI! Je veux m'abonner au Club LEGO GRATUITEMENT! Ja! Ich möchte Mitglied im kostenlosen LEGO Club werden. Ja! Ik wil graag GRATIS lid worden van de LEGO Club. Ja! Jeg ønsker å melde meg inn i LEGO Club gratis! Ja! Jag vill gå med i LEGO Club GRATIS!**

First name - Prénom  
Vorname - Voornaam  
Fornavn - Förnamn

Last name - Nom de Famille  
Name - Achternaam  
Etternavn - Efternavn

Date of Birth - Date de naissance  
Geburtsdag - Geboortedatum  
Fødselsdato - Födelsedatum

Boy - Garçon  
Junge - Jongen  
Gutt - Pojke

Girl - Fille  
Mädchen - Meisje  
Jente - Flicka

Street - Adresse  
Straße, Hausnr.  
Straat, huisnr. - Adress

City - Ville  
Ort - Woonplaats  
Poststed - Postort

State  
Prov.  
County

Zip/Postcode - Code Postal  
PLZ - Postcode - Postnummer

Country  
Pays - Land

Please tick below if you would like to receive other communication from the LEGO Group. *S'il vous aimeriez recevoir d'autres communications de la part de la Compagnie LEGO, veuillez s.v.p. cocher ici.* Als u graag verdere informatie van de LEGO Groep wilt ontvangen, kruis dan a.u.b. dit vakje aan. Ich möchte über Produkte, Angebote, Aktionen und weitere interessante Themen von der LEGO Gruppe informiert werden\* (bitte ankreuzen). Om du vill få annen informasjon fra LEGO Gruppen, søtt kryss här. Hvis du ønsker å motta annen informasjon fra LEGO Gruppen, merker du av her.

Post - Poste  
Per Post

Email - Courriel  
Per E-Mail  
E-Mail

Ich möchte über Produkte, Angebote, Aktionen und weitere interessante Themen von sonstigen LEGO Partnerunternehmen informiert werden\* (bitte ankreuzen).  Per Post  Per E-Mail

Mail to: / Poster à:



BG29

Mail to:



BI09U

Per Post an:



BI09C

Stuur op naar:



BI09N

Send til:



BI09O

Skickas till:



BI09S

LEGO Club  
P.O. Box 1157  
EnField, CT USA  
06083-1157

LEGO Club  
33 Bath Road  
Slough SL1 3UF  
United Kingdom

LEGO Club  
Postfach 14 15  
D-36243 Niederauka

LEGO Club  
Postbus 40250  
3504 AB Utrecht

LEGO Club Norge  
Postboks 58  
1314 Vøyenenga

LEGO Club Sverige  
Ubox 841  
202 29 Malmö

The English language version of the magazine can only be mailed to addresses in the US, Canada, the UK, and Republic of Ireland. Club membership is valid for two years and includes free copies of the LEGO Club Magazine. In the US and Canada please allow up to 6 weeks for delivery of your first magazine. In the UK and Republic of Ireland please allow six to 14 weeks for delivery of your first magazine. By signing this form you consent the LEGO Club to use your child's data for LEGO mailings. The data will only be used for LEGO mailings and will not be sold, rented or otherwise disclosed to any company outside the LEGO Company except for disclosure to companies acting as our agents to help us provide services requested by the child. This coupon is valid for one free membership per person, group or organisation. Photocopied coupons are accepted. La version française du magazine peut être postée uniquement au Canada. L'abonnement est valide pour 2 ans et inclut des exemplaires gratuits du Magazine LEGO. Aux E.-U. et au Canada, allowez 6 semaines pour la livraison initiale. En remplissant ce formulaire, vous consentez à ce que LEGO utilise les informations de votre enfant pour des envois postaux de LEGO. L'information sera utilisée uniquement pour des envois postaux par LEGO et ne sera en aucun cas, vendue, louée, échangée ou divulguée à d'autres compagnies autres que la compagnie LEGO, à l'exception des compagnies affiliées qui nous procurent des services auxquels l'enfant en a fait la demande. Das deutschsprachige LEGO Club Magazin kann nur an Adressen in Deutschland, Österreich und der Schweiz verschickt werden. Die kostenlose Mitgliedschaft beinhaltet die Zusendung des LEGO Club Magazins und endet nach zwei Jahren. Mit der Anmeldung gehen Sie keine Verpflichtungen ein. Es kann bis zu drei Monate dauern, bis das erste Magazin zugestellt wird. Mit Ihrer Unterschrift erklären Sie sich damit einverstanden, dass die Daten Ihres Kindes zum Zweck einer LEGO Club Mitgliedschaft von der LEGO Gruppe gespeichert und verarbeitet werden. Die Daten werden vertraulich behandelt, nicht an Dritte weitergegeben und nicht veräußert. Externe Dienstleister erhalten Ihre Daten nur, soweit es für die Abwicklung von LEGO Kommunikation erforderlich ist. Wenn Sie von uns nicht mehr kontaktiert werden möchten, können Sie der Verwendung Ihrer Daten für Werbezwecke widersprechen unter: 00800 5346 5555 (Anruf gebührenfrei, Kosten für Anrufe aus Mobilfunknetzen können abweichen). \* Die Einwilligungen kann ich jederzeit (insgesamt oder zum Teil) ohne Einfluss auf die LEGO Club Mitgliedschaft bei der LEGO Gruppe widerrufen. Het LEGO Club Magazine kan alleen worden gestuurd naar adressen in Nederland. Het lidmaatschap is 2 jaar geldig en geeft recht op toezending van het gratis LEGO Club Magazine. Het eerste magazine zal na 12 tot 14 weken toegestuurd worden. Het lidmaatschap kan op ieder moment opgezegd worden. Door dit formulier te tekenen geeft u de LEGO Club toestemming om bovenstaande gegevens te gebruiken voor het toezenden van LEGO mailings. Uw gegevens worden uitsluitend gebruikt voor mailings van LEGO en zullen niet worden verkocht, verhuurd of op welke wijze dan ook verstrekt aan derden buiten de LEGO Groep, uitgezonderd de organisaties die namens ons optreden om de service te verlenen waar uw kind om gevraagd heeft. Den norske utgaven av magasinet sendes kun til adresser i Norge. Medlemskap i klubben gjelder i 2 år og inkluderer gratisutgaver av LEGO Magazine. Påregnet opptil seks uker leveringstid for første magasin. Ved å undertegne dette skje mået, gir du ditt samtykke til at LEGO Club kan bruke opplysningene om barnet ditt i LEGO forsendelser. Dataene vil utelukkende bli brukt i LEGO forsendelser og vil ikke bli solgt, utleid eller på annen måte gjøres tilgjengelig for selskaper utenfor LEGO gruppen, unntatt selskaper som er våre agenter og som hjelper oss å tilby tjenestene barnet etter spør. Dette skje mået gjelder for ett gratis medlemskap per person, gruppe eller organisasjon. Den svenska versionen av tidningen kan endast skickas till adresser i Sverige. Club-medlemskapet är giltigt i 2 år och innefattar gratis exemplar av LEGO Club Magazine. Vänligen räkna med 6 veckor för leverans av din första tidning. Genom att skicka in det här formuläret godkänner du att LEGO Club använder barnets uppgifter för LEGO utskick. Uppgifterna kommer bara att användas för LEGO utskick och kommer inte att säljas, hyras ut eller vidarebefordras till något företag som inte tillhör LEGO Gruppen, med undantag av företag som agerar som våra ombud för att tillhandahålla tjänster som barnet har begärt. Den här kupongen gäller för ett gratis medlemskap per person, grupp eller organisation.

Parent's signature - Signature d'un parent - Unterschrift Erziehungsberechtigte/r

Handtekening ouders - Foreldres/Foresettes underskrift - Förälders/Förmyndares underskrift

Date

Datum

Date

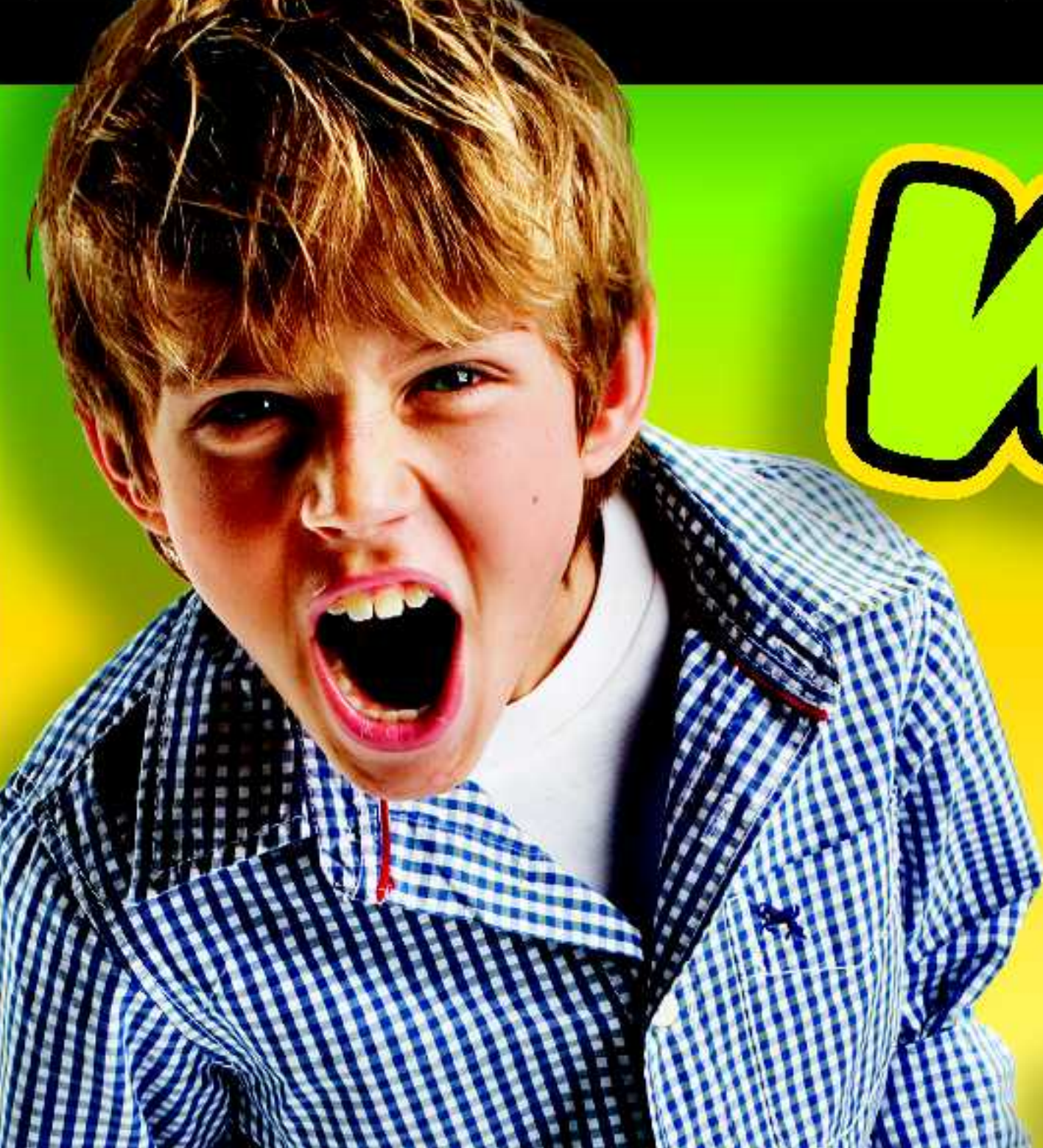

# WIN!

Go to [www.nielsen.com/LEGO](http://www.nielsen.com/LEGO) to fill out a survey for a chance to win a cool LEGO® Product. No purchase necessary. Open to all residents where not prohibited.

 [www.LEGO.com](http://www.LEGO.com)



## [www.nielsen.com/LEGO](http://www.nielsen.com/LEGO)

### GEWINNE! WIN!

Nimm an der Umfrage auf [www.nielsen.com/LEGO](http://www.nielsen.com/LEGO) teil und hab die Chance ein cooles LEGO® Produkt zu gewinnen!

Die Teilnahme am Gewinnspiel führt zu keinerlei Kaufverpflichtungen. Teilnahme in allen nicht ausgeschlossenen Ländern möglich.

Ga naar [www.nielsen.com/LEGO](http://www.nielsen.com/LEGO), vul een enquêteformulier in en maak kans op een cool LEGO® product.

Geen aankoopverplichting. Iedereen mag deelnemen, uitgezonderd ingezetenden van landen waar een enquêteverbod geldt.

### GAGNE! 当てよう!

Visite [www.nielsen.com/LEGO](http://www.nielsen.com/LEGO) pour répondre à un questionnaire et avoir une chance de gagner un produit LEGO® très cool!

Aucune obligation d'achat. Ouvert à tous les résidents des pays autorisés.

[www.nielsen.com/LEGO](http://www.nielsen.com/LEGO)にアクセスして、アンケートにご記入ください。当選者にはレゴ製品を差し上げます。

お買い上げの必要はありません。禁止されていない限り、すべての皆様にご利用いただけます。