

BIONICLE®

GELU

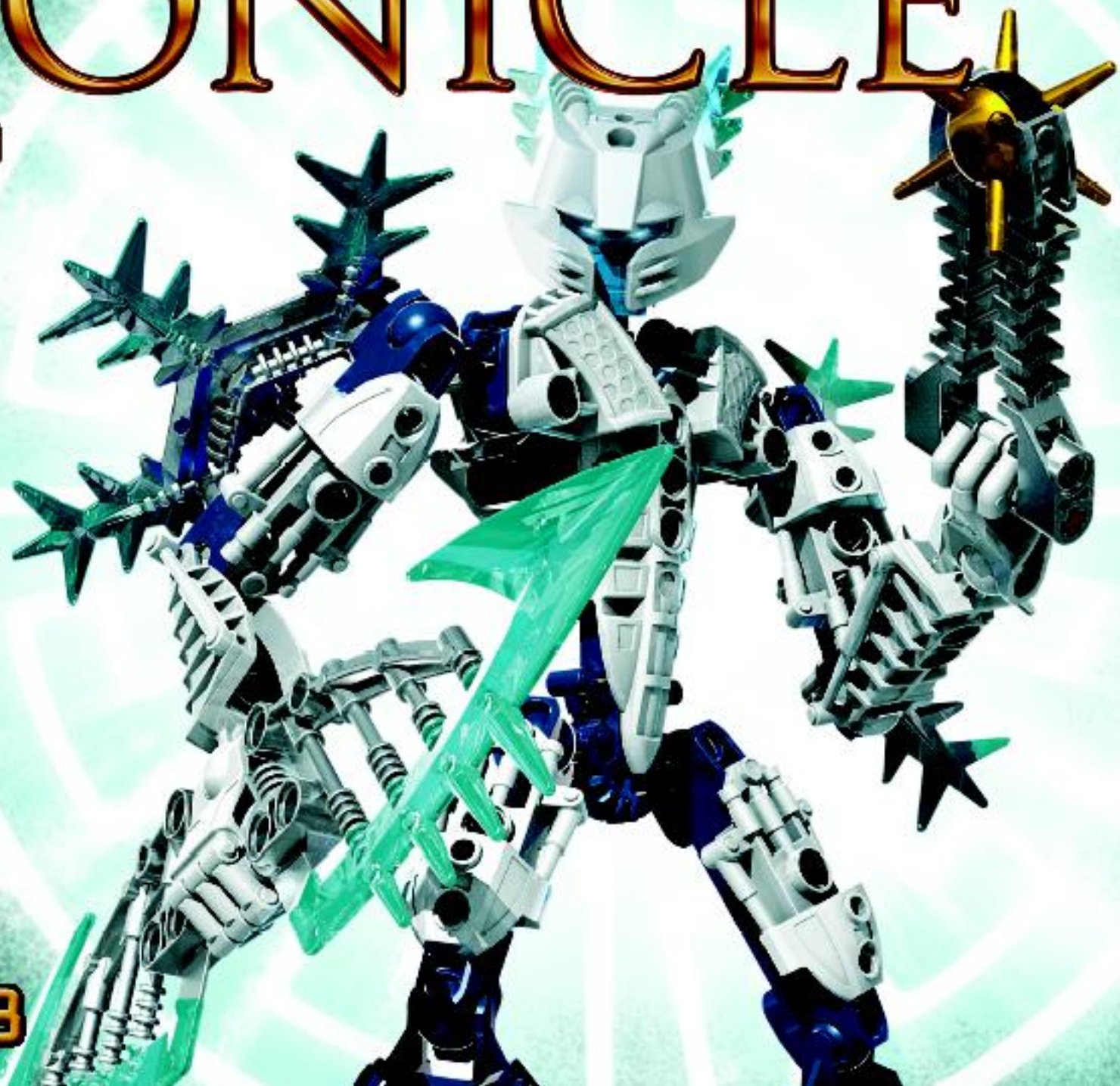

CAUTION: Do not aim at eyes or face.
ATTENTION: Ne pas viser les yeux ni le visage.
PRECAUCIÓN: No lo dirija a los ojos o cara.

8988



1

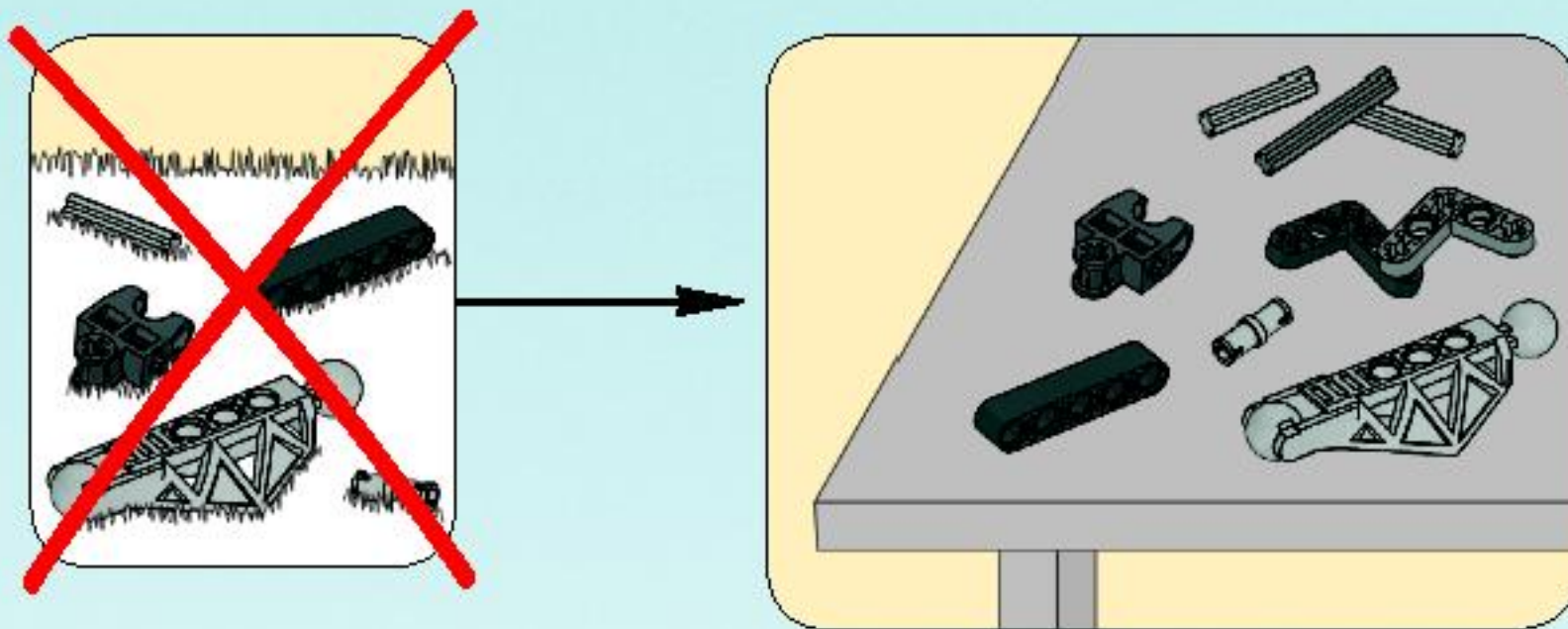

2

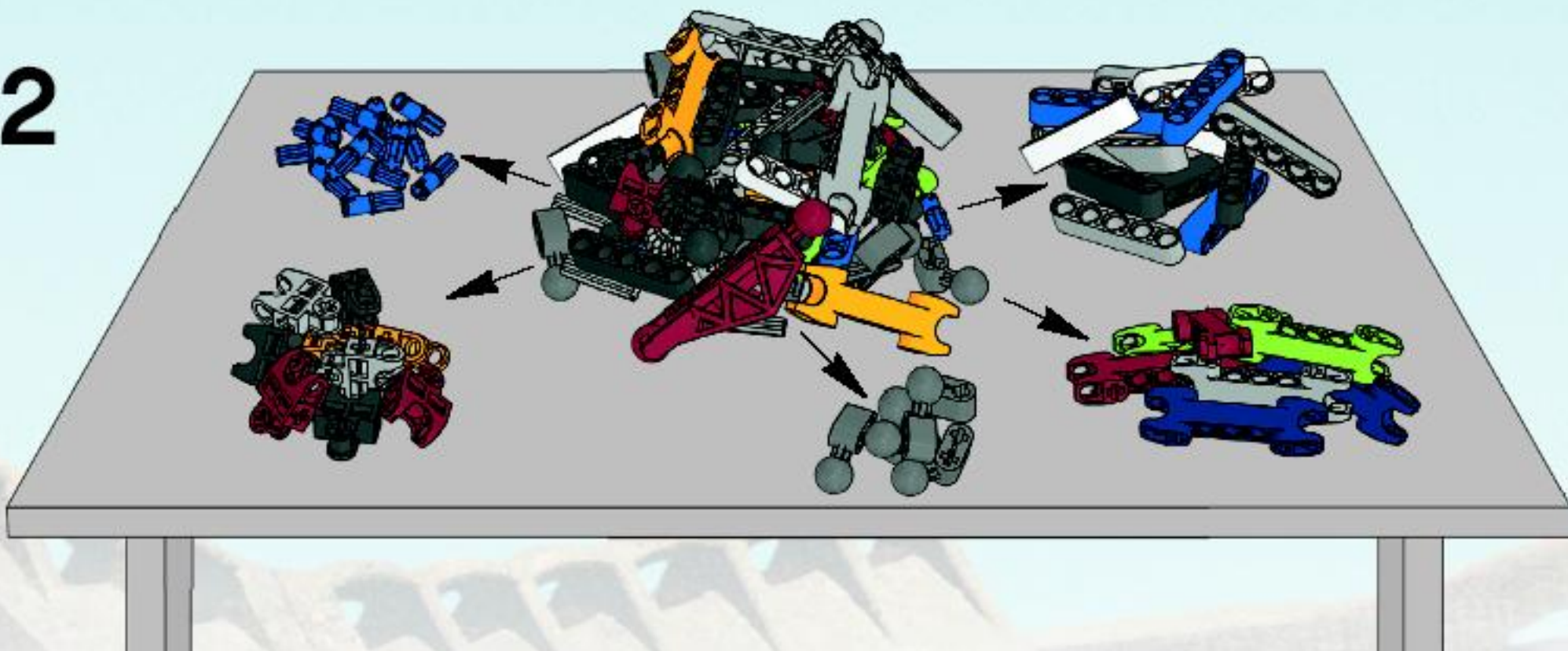

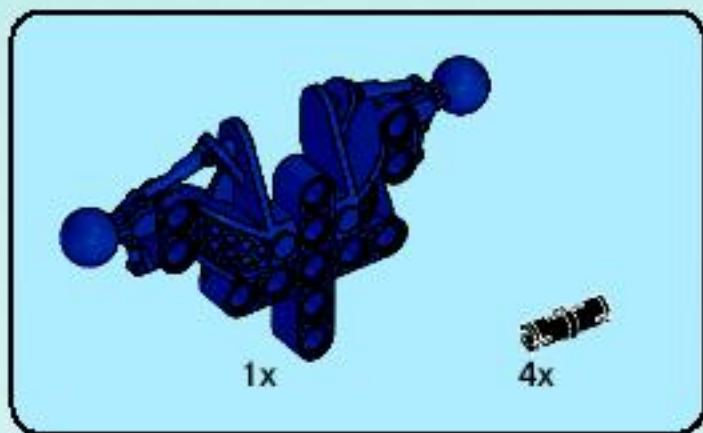

1

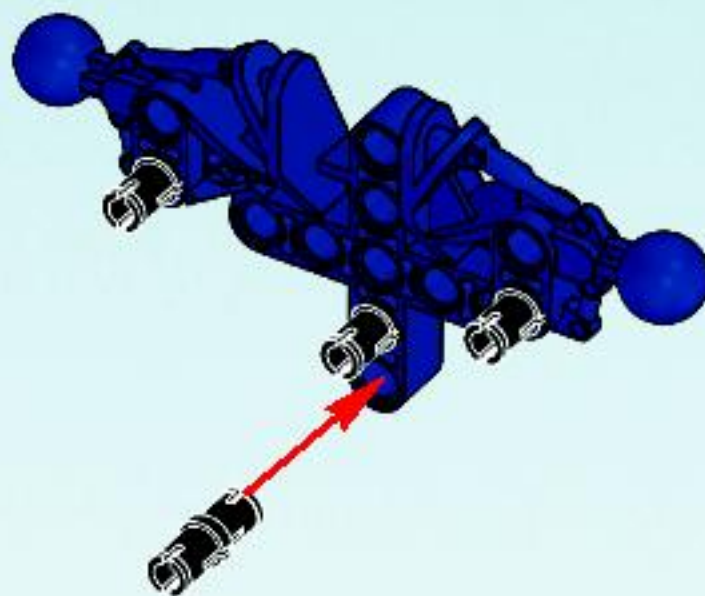

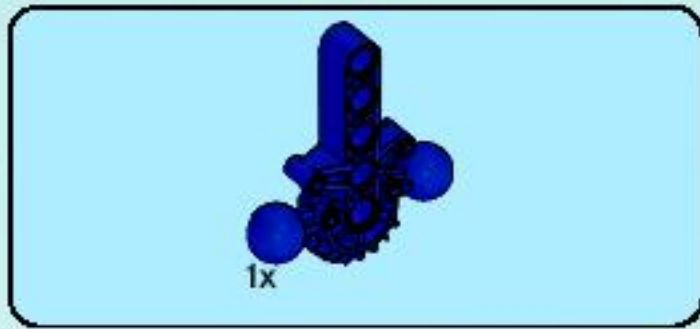

2

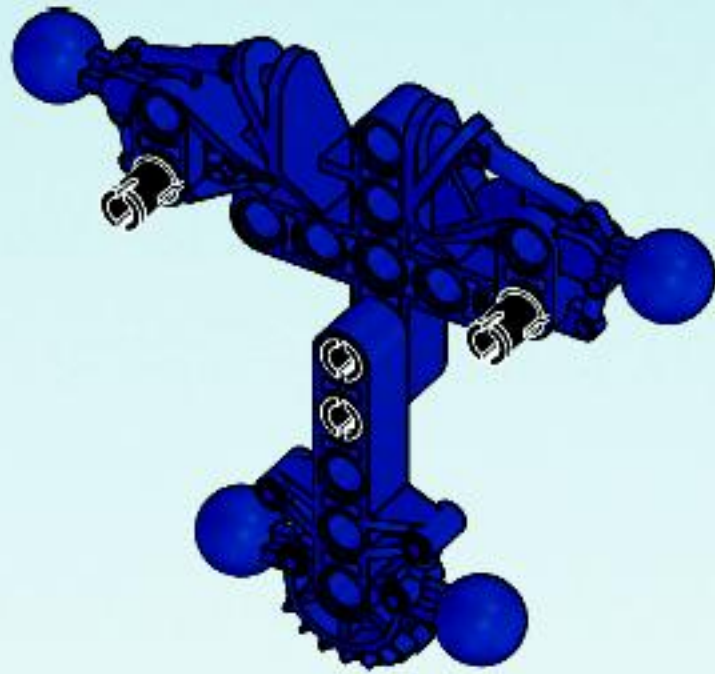



3

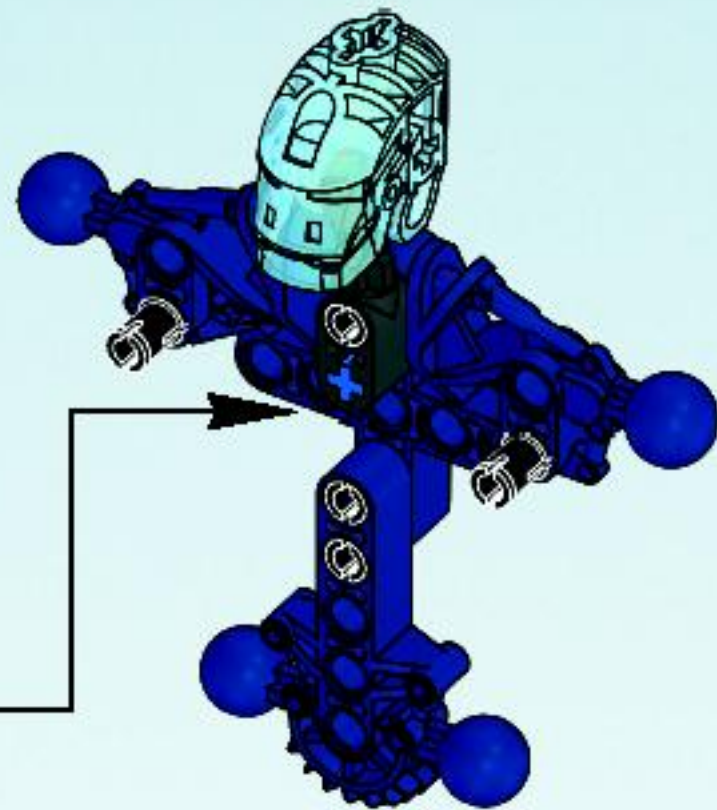
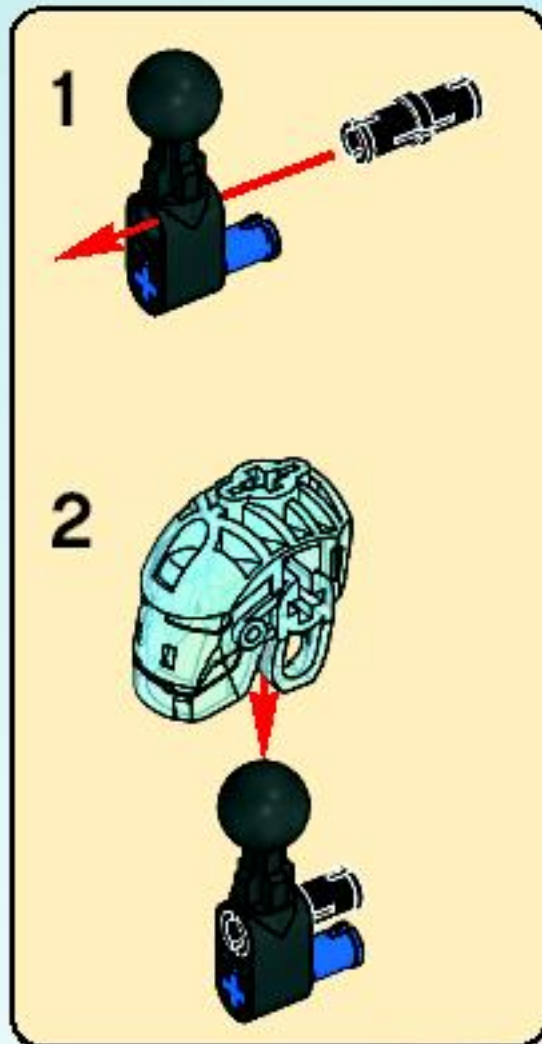



4

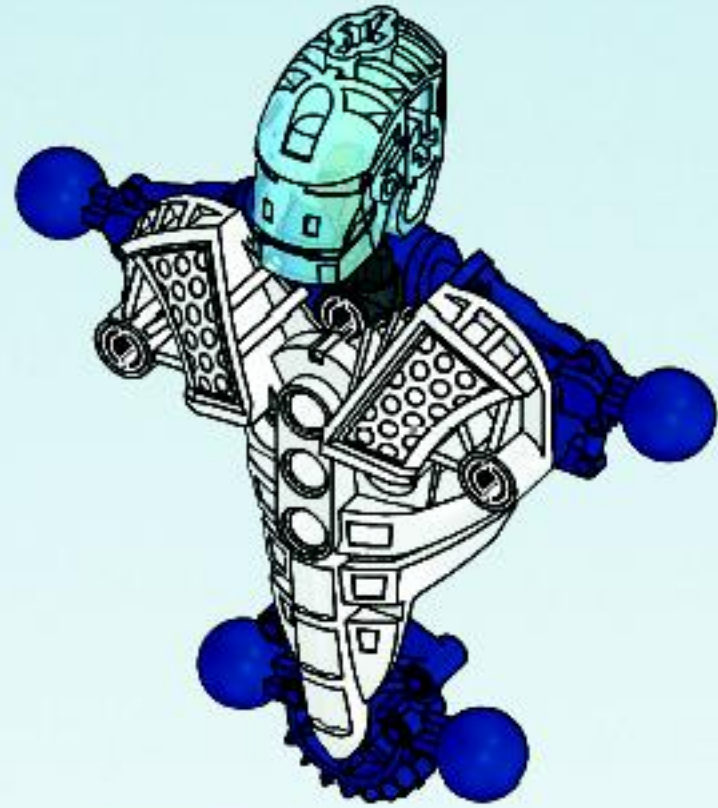

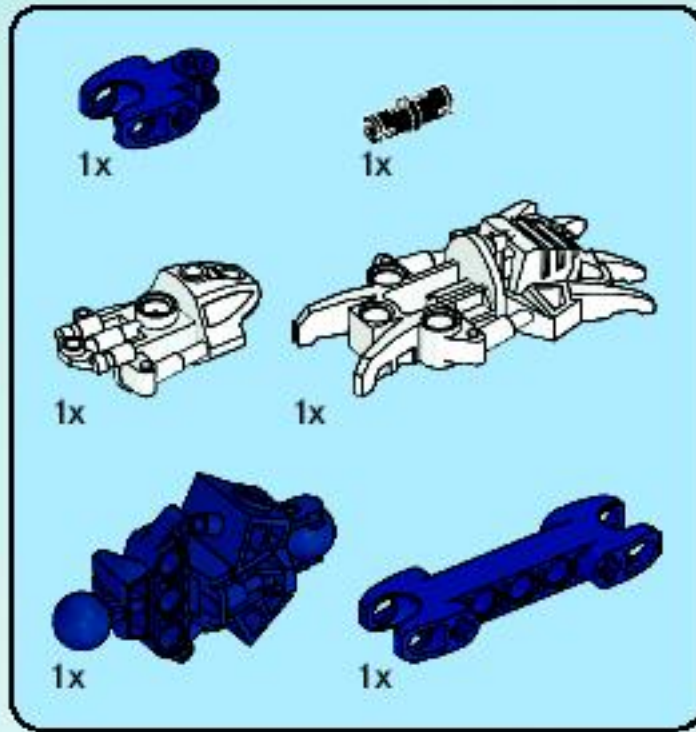
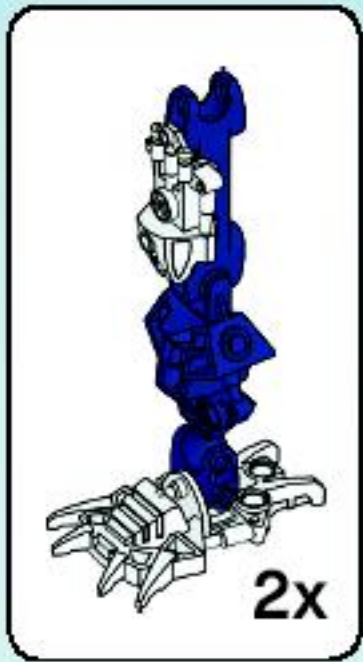

5

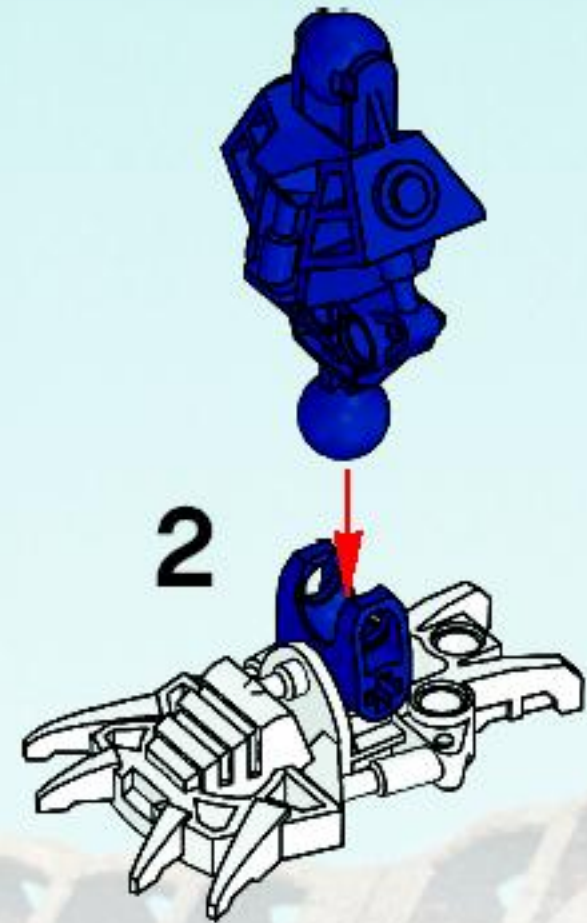
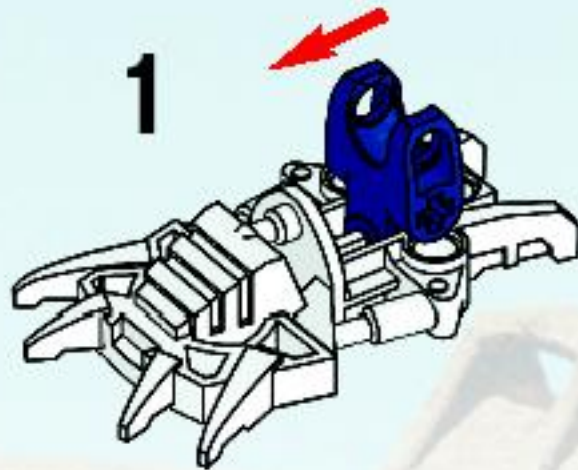

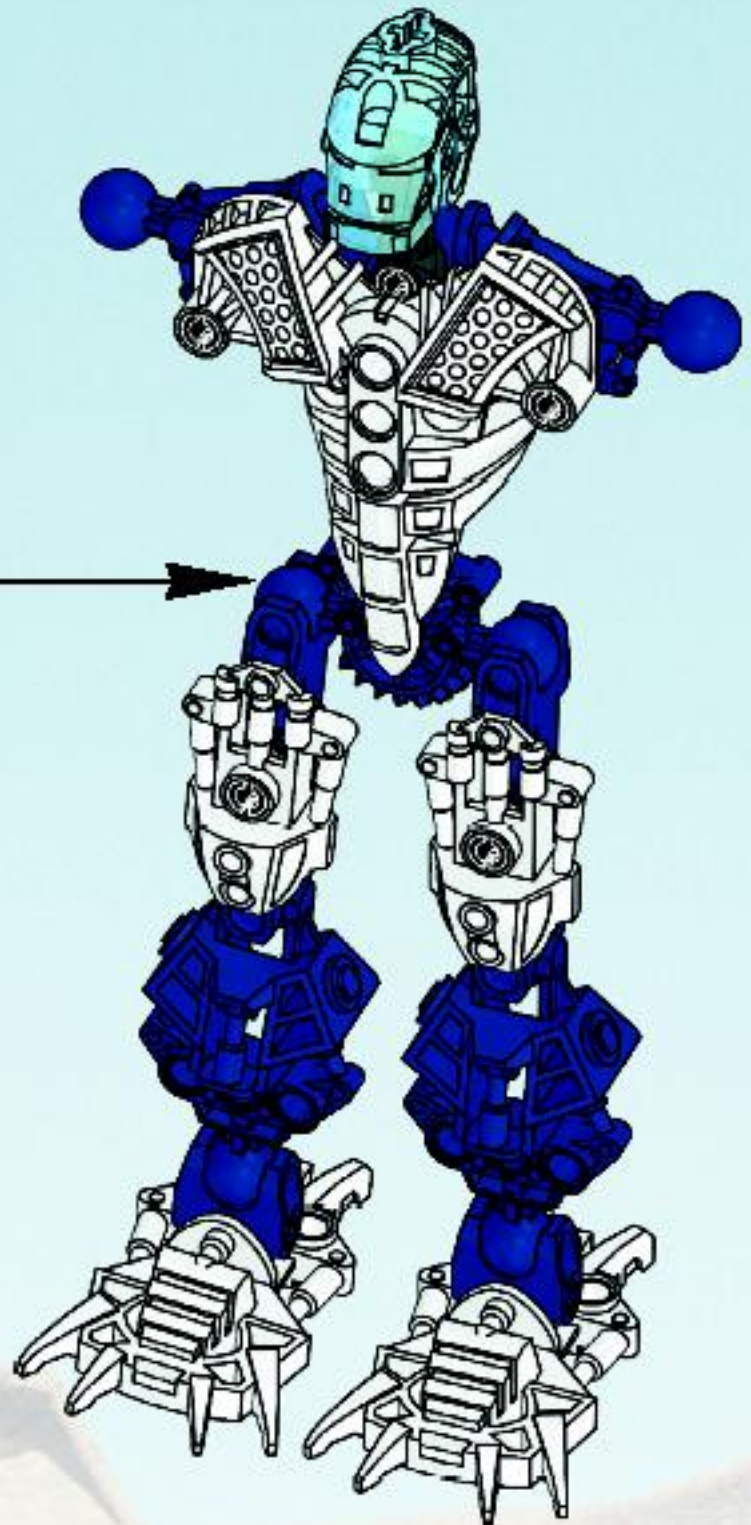
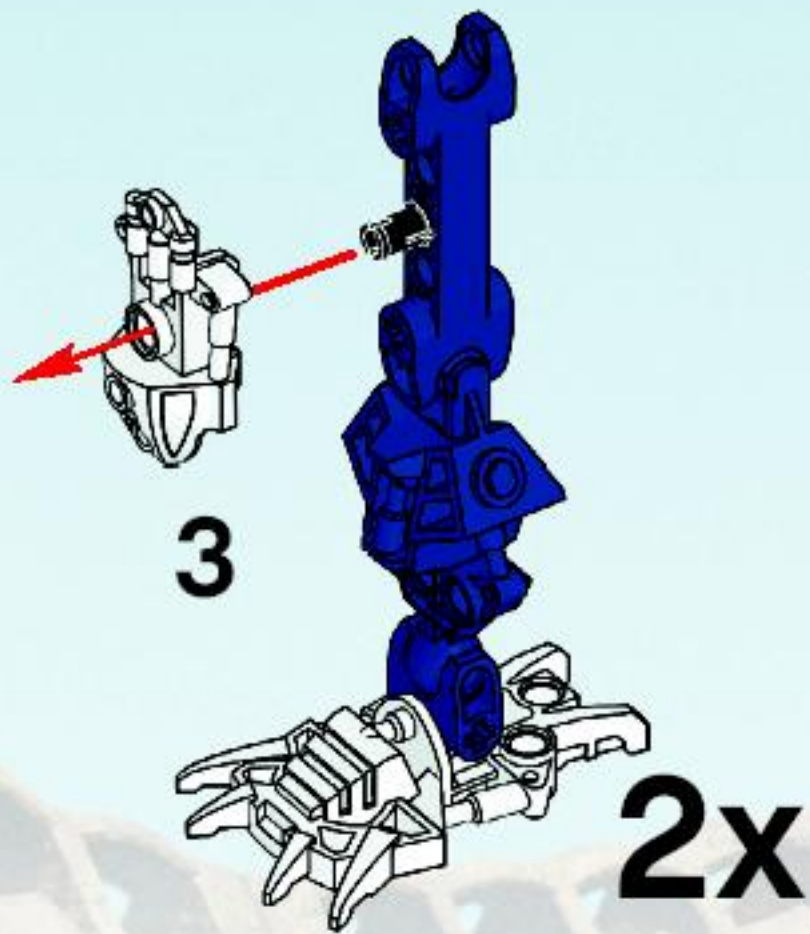

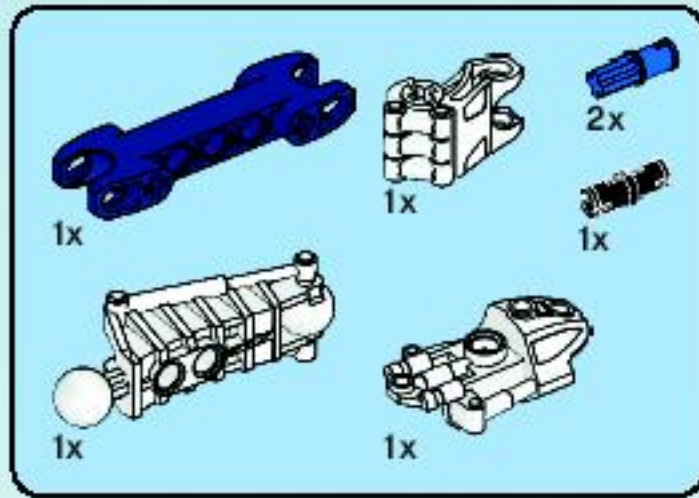
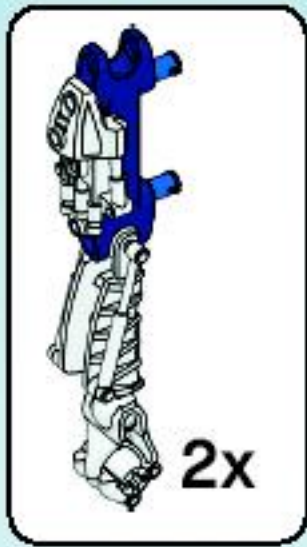

6

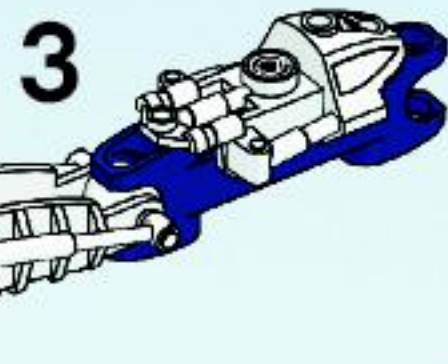
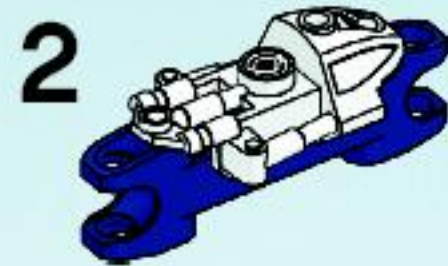
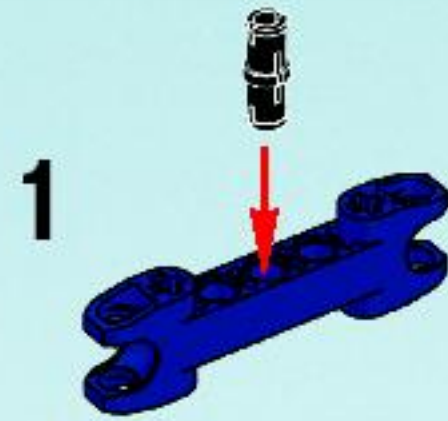

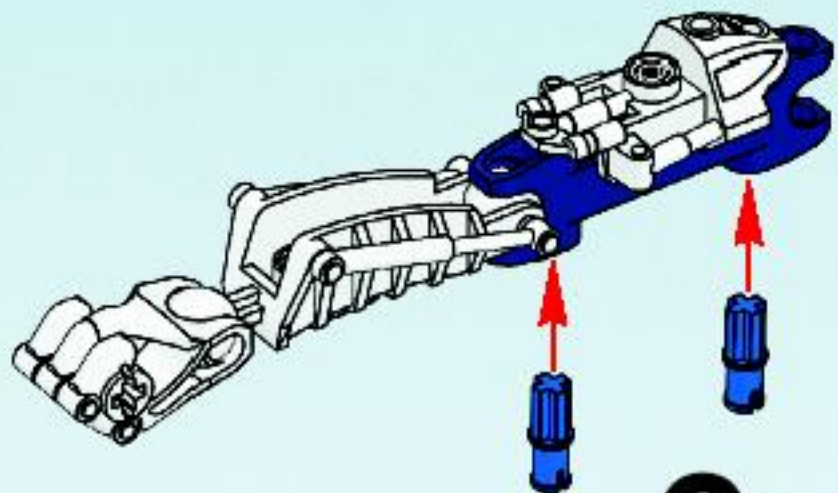

2x

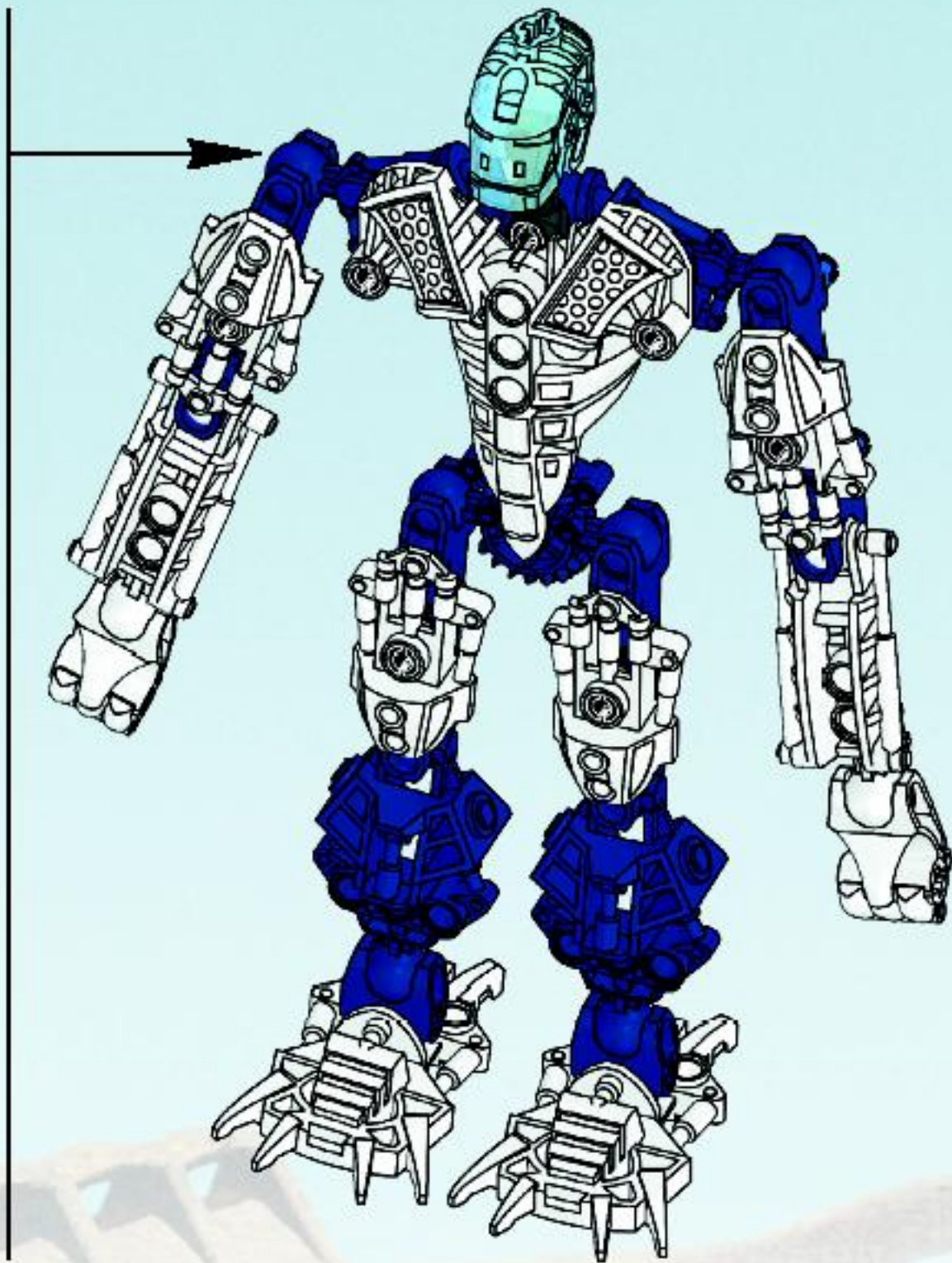

2x



7

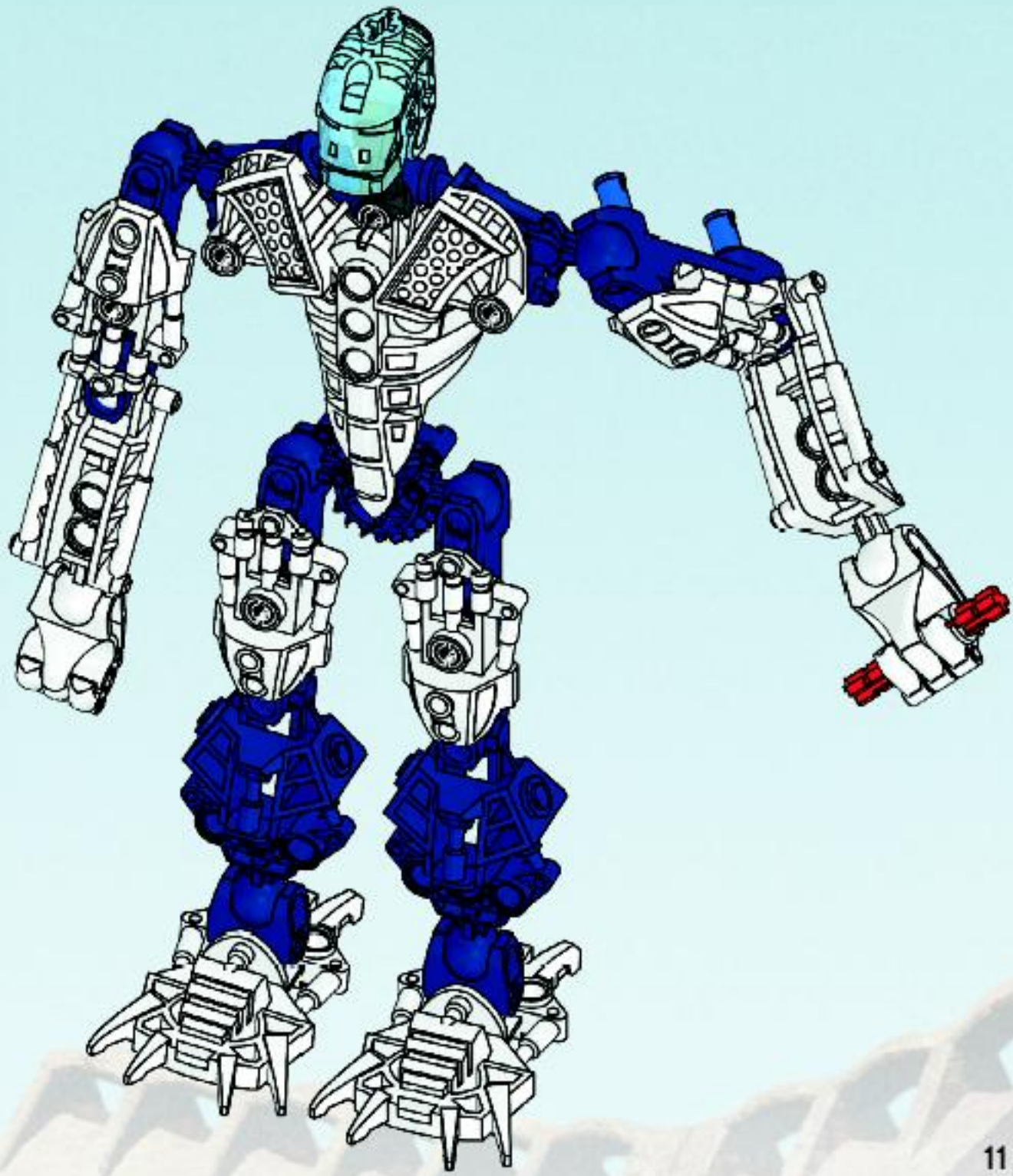

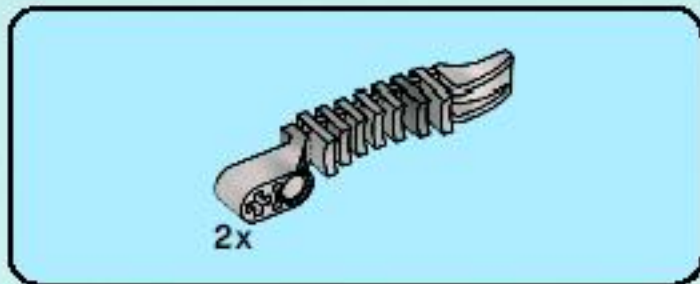

8

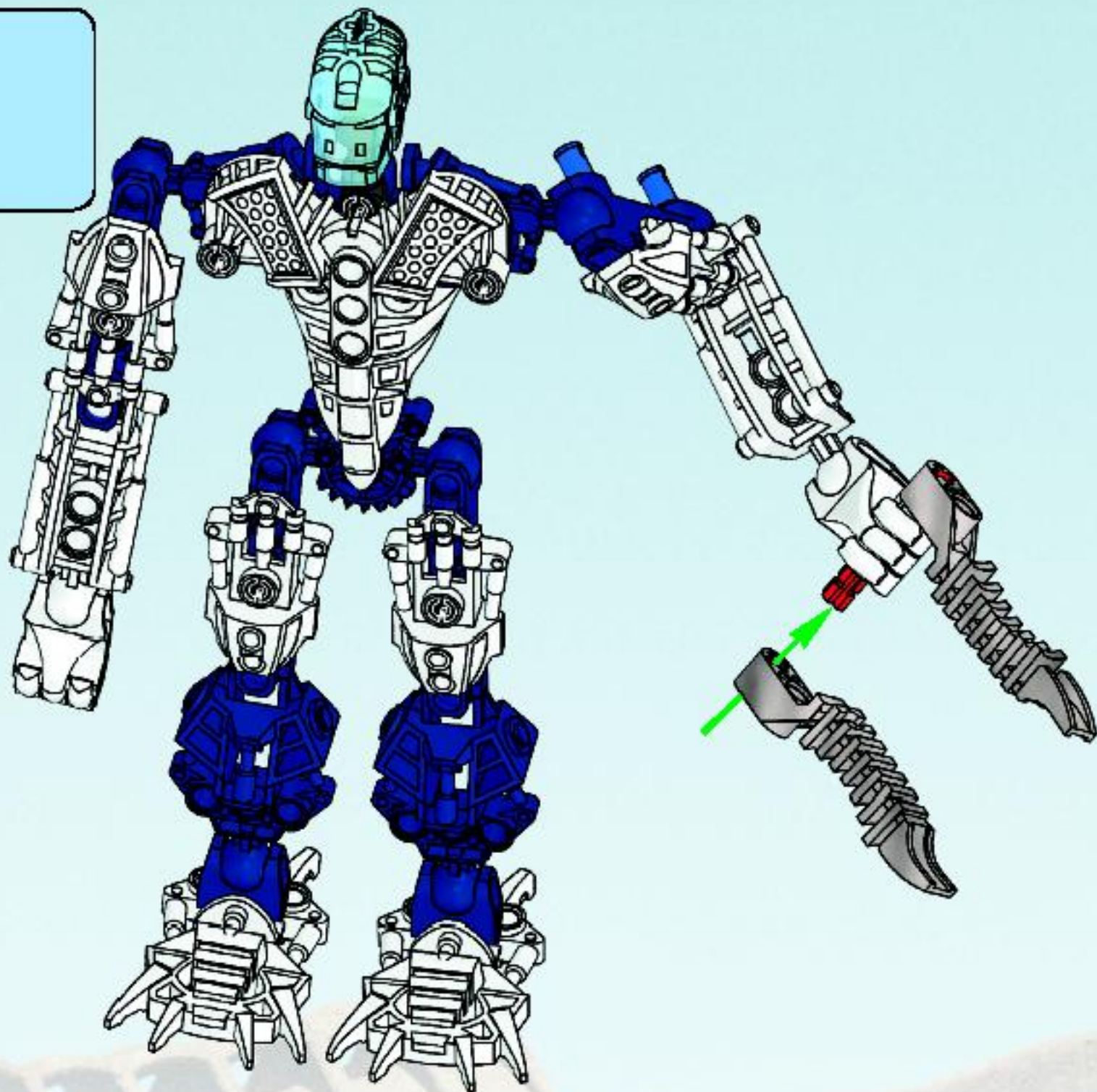

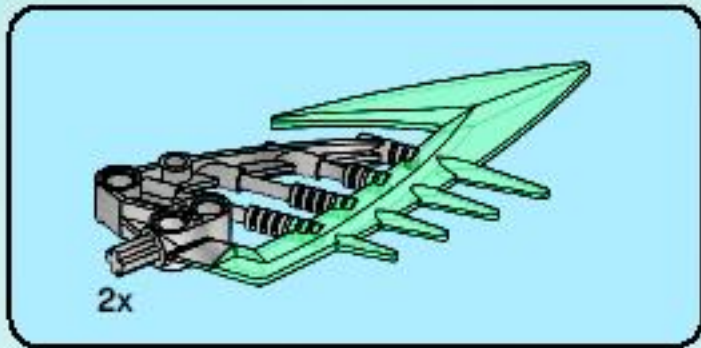

9

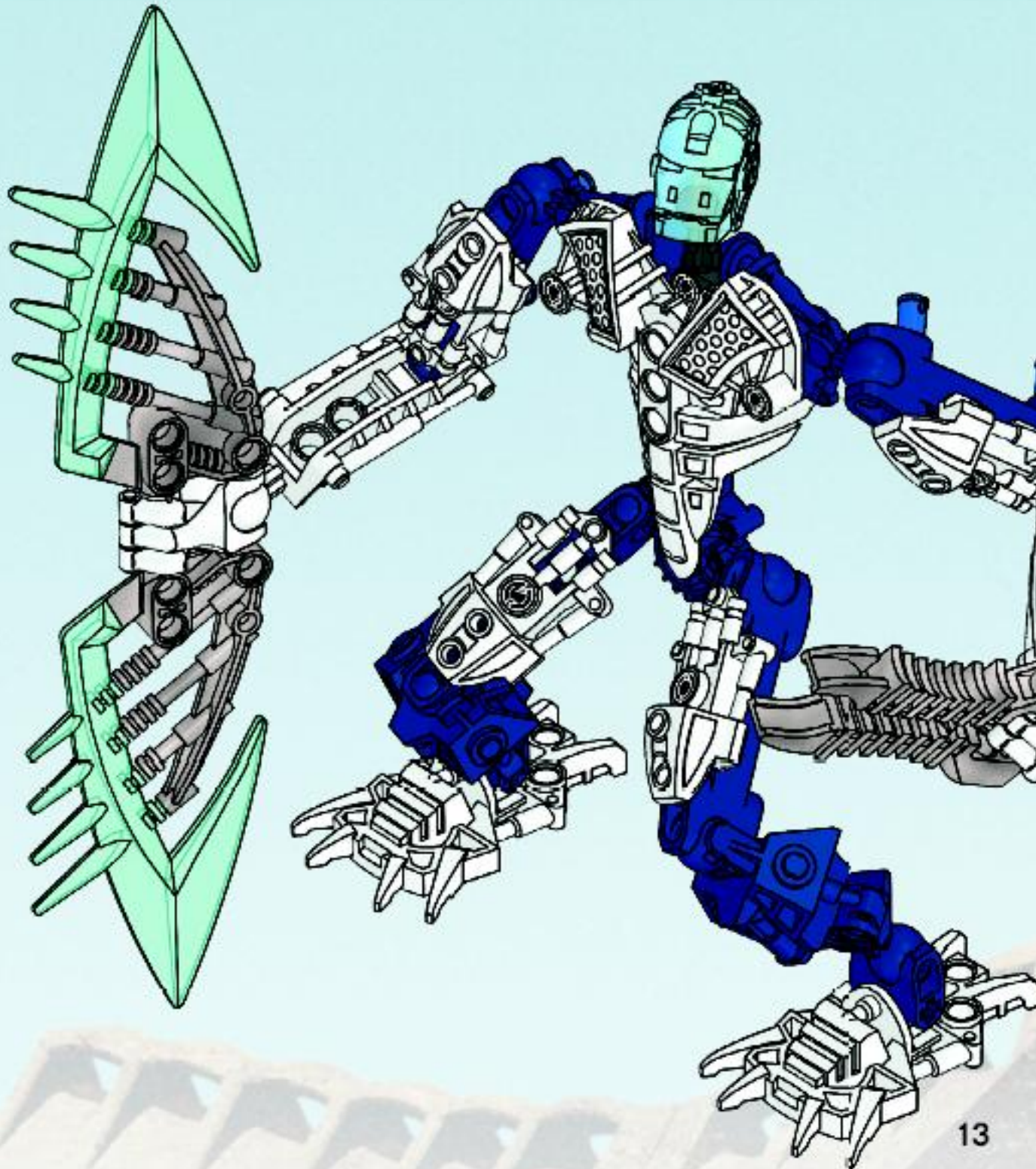

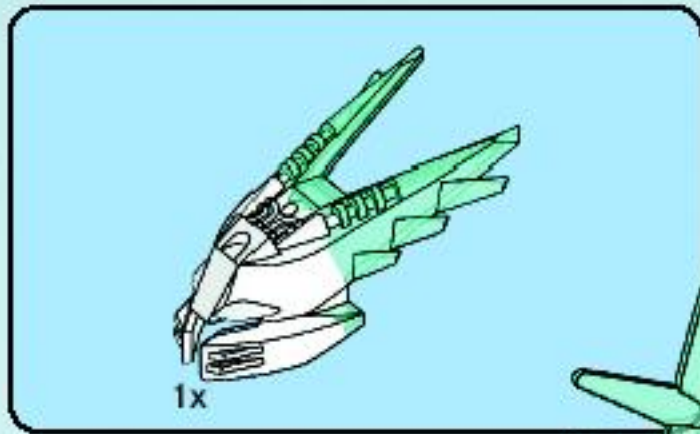

10

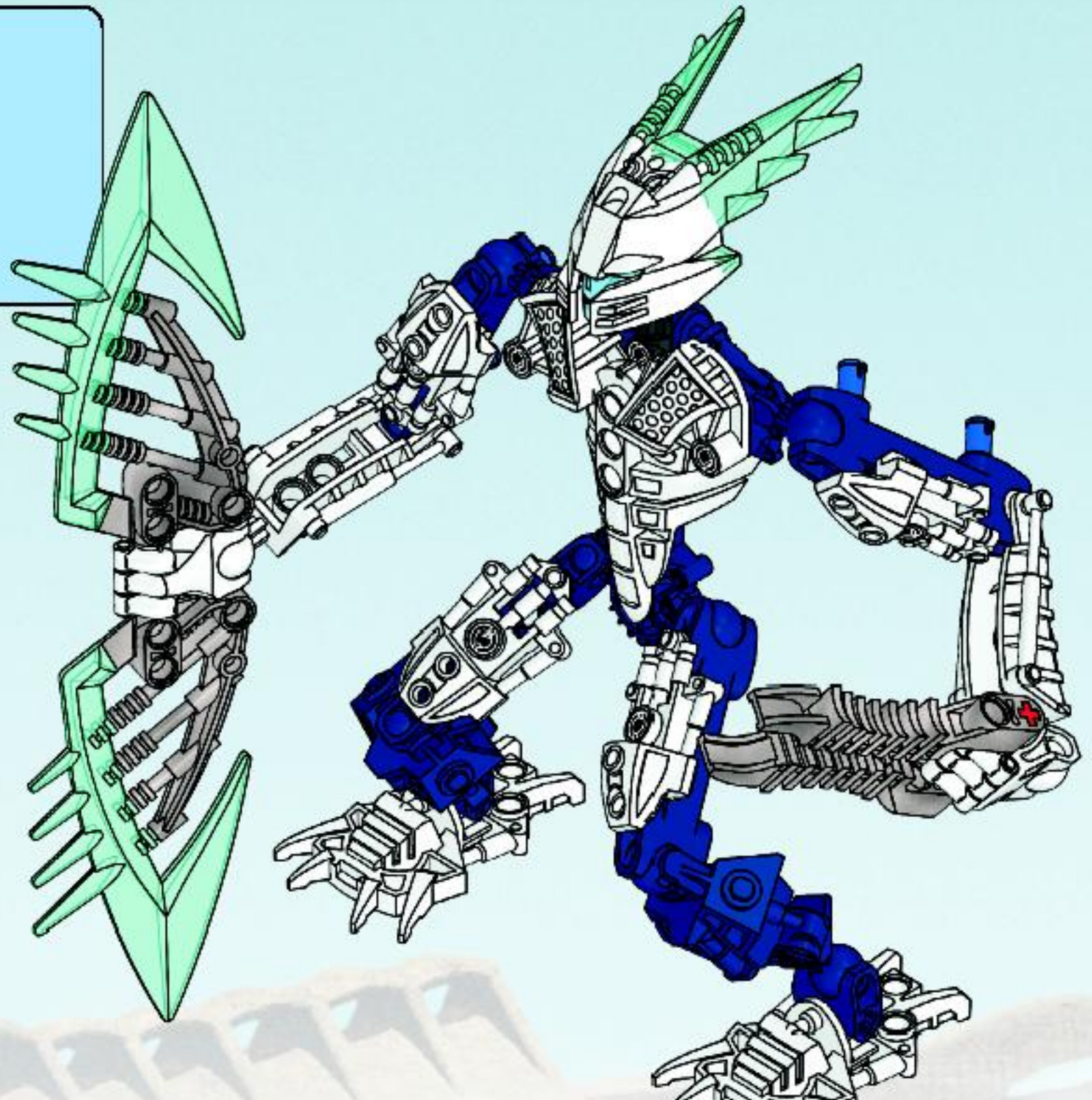



11

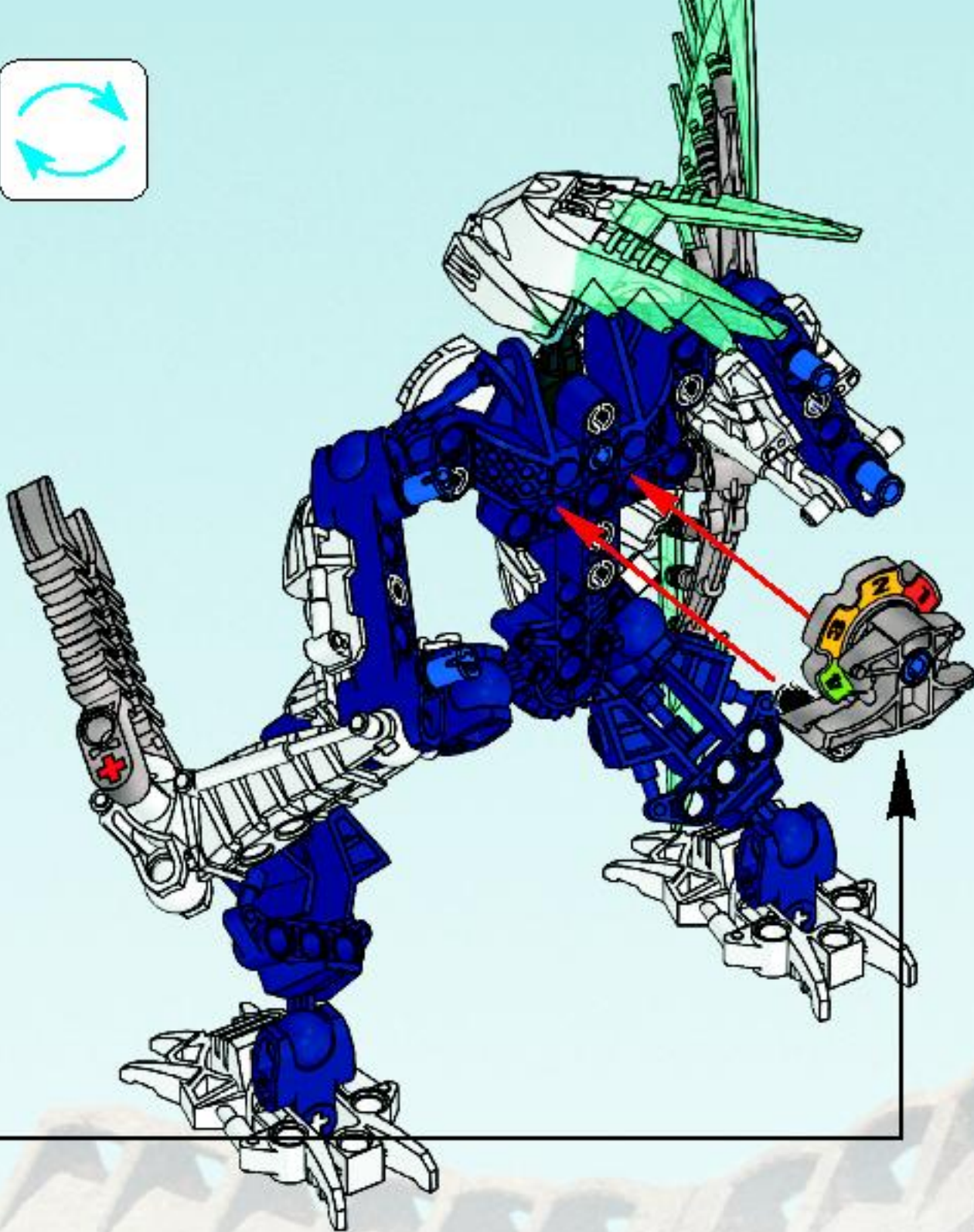
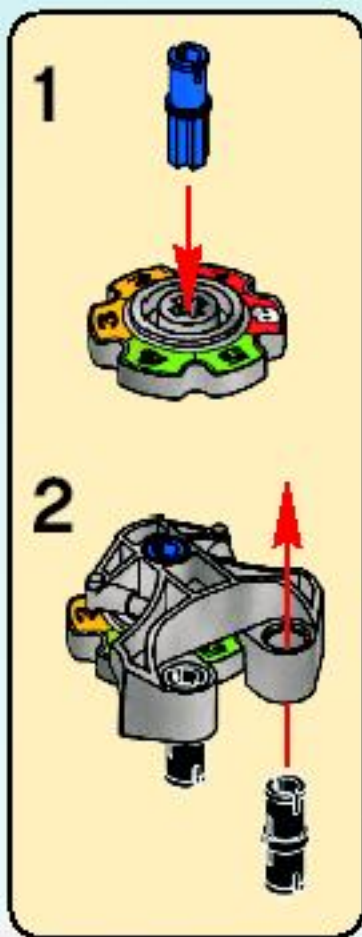

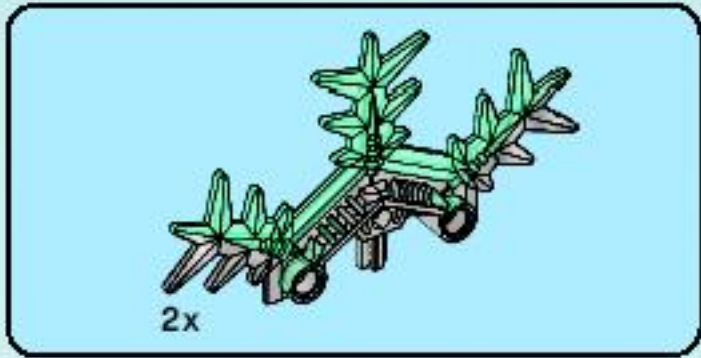

12



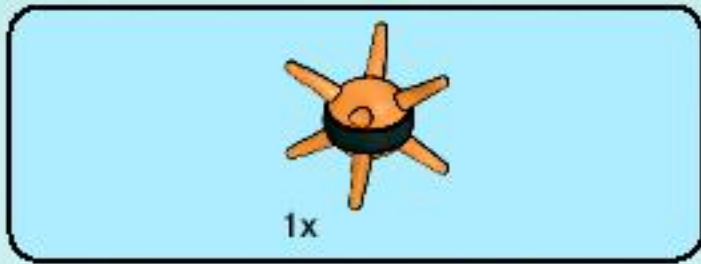

13

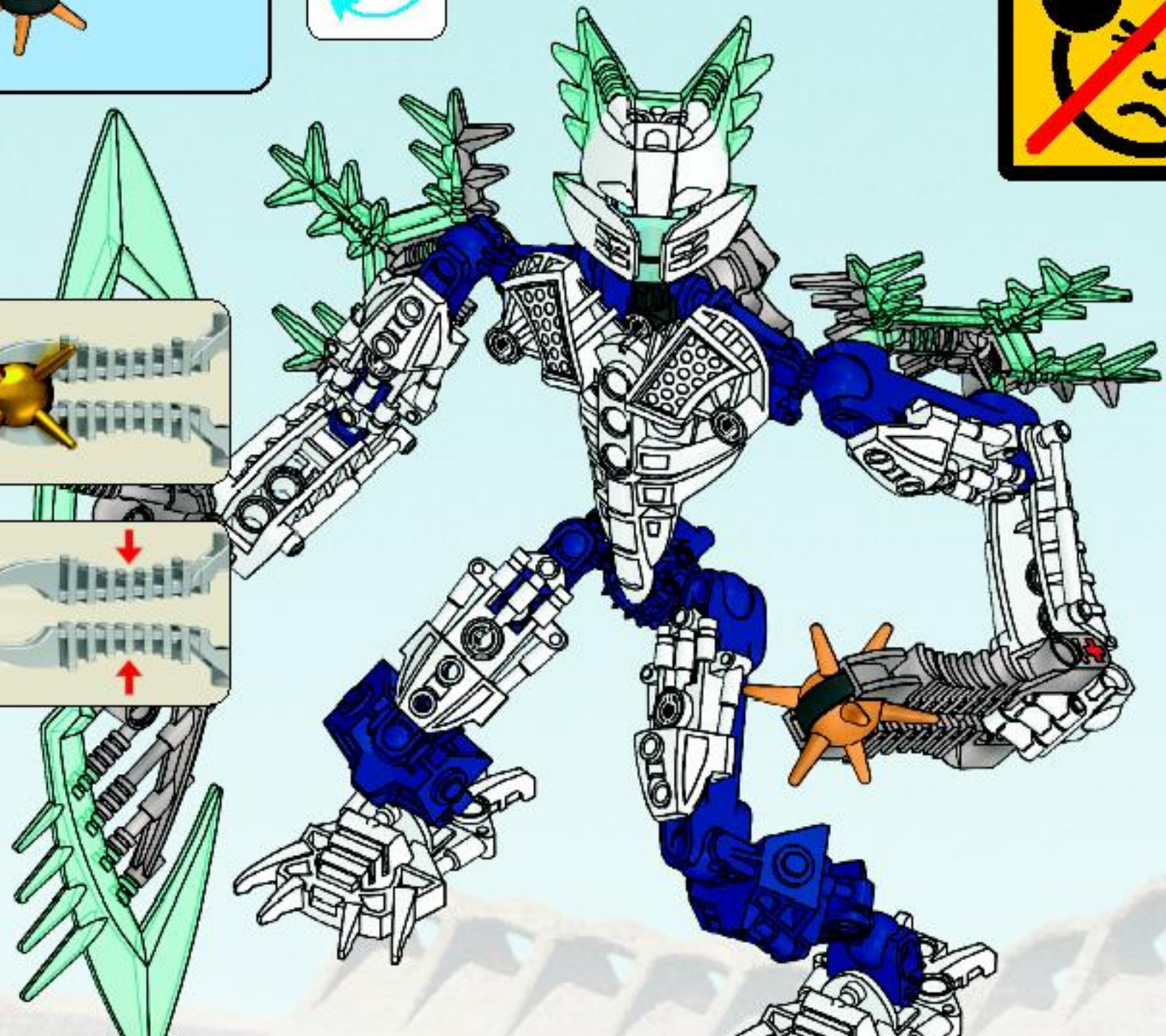



1x
4544529



1x
4537503



2x
4539157



2x
4527059



1x
4544660



1x
4247224



1x
4560108



4x
4281240



1x
4278500



2x
4537507



2x
4546416



11x
4121715

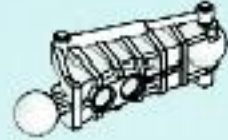

2x
4278479



2x
4289381



1x
4546585



2x
4142865



2x
4548168



4x
4525998



2x
4544659



6x
4206482



1x
4292552



1x
4297132



Customer Service

Kundenservice

Service Consommateurs

Servicio Al Consumidor

www.lego.com/service or dial



00800 5346 5555 :



1-800-422-5346 :





ALL-NEW MOVIE ON DVD

FALL 2009

UN TOUT NOUVEAU FILM EN DVD AUTOMNE 2009
UNA PELÍCULA TOTALMENTE NUEVA EN DVD OTOÑO 2009



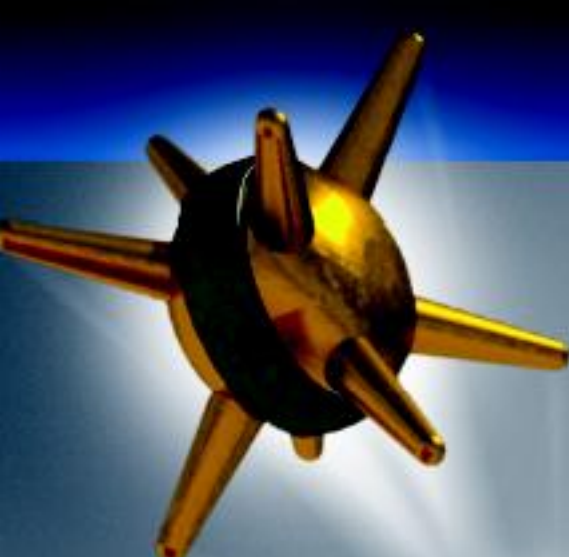

BIONICLE ACTION FIGURE
GAME



Setting Up Préparer le jeu

Prepara el juego

This game is about taking the life of your opponent before he takes yours!

1. Set up the game using 2 cans & 2 figures
2. Set the dial to 5
3. Decide who goes first

Pour gagner, il faut que tu t'empares de la vie de ton adversaire avant qu'il ne s'empare de la tienne !

1. Installe le jeu en utilisant 2 boîtes et 2 figurines
2. Positionne le cadran sur 5
3. Décide qui commence

¡El objetivo de este juego es ganar la vida de tu oponente antes que él gane la tuya!

1. Prepara el juego utilizando 2 latas y 2 figuras
2. Coloca el marcador en 5
3. Decide quién empezará



1. Hit can and opponent loses 1 life point or hit figure and opponent loses 2 points.

1. Si tu touches la boîte, ton adversaire perd 1 point de vie et si tu touches la figurine, ton adversaire perd 2 points.

1. Golpea la lata para que tu oponente pierda 1 punto de vida, o golpea la figura para que pierda 2 puntos de vida.



Playing the game: **MOVE**
Jouer au jeu : **AVANCE**

Cómo jugar: **AVANZA**

1. After shooting move figure to where ball lands.

1. Après avoir tiré, déplace la figurine à l'endroit où la balle a atterri.

1. Después de disparar, mueve la figura hasta el lugar en el que haya caído la bola.



Winning the game
Gagner la partie

Gana el Juego

1. The first player to take all the opponent's life points wins!

1. Le premier joueur qui s'empare de tous les points de vie de son adversaire gagne !

1. ¡El primer jugador que junte todos los puntos de vida de su oponente ganará!



For more rules on advanced multi-figure game play - check out



Weitere Informationen und Anleitungen für coole Spiele mit mehreren Figuren findest du unter



Retrouve toutes les règles du jeu multi-joueur sur



Pour plus d'information concernant les règles des jeux de niveau avancé avec plusieurs figurines, visite



Para más información sobre instrucciones de juego avanzado con varias figuras, consulta



Para más información sobre instrucciones de juego avanzado con varias figuras, consulta

www.BIONICLE.com





8996



8995



8992



8993



8994





STRONIUS
8984



ACKAR
8985



VASTUS
8986

GLATORIAN LEGENDS



KIINA
8987



GELLU
8988



MATA NUI
8989

BIONICLE



SKOPIO XV-1
8996



BARANUS V7
8994



THORNATUS V9
8995



CENDOX V1
8992



KAXILUM V3
8993



ATAKLUS
8972



RAANU
8973



TAROUK
8974



BERIX
8975



METUS
8976



ZESK
8977



WWW.BIONICLE.COM



FREE! GRATIS! GRATUIT!



club
MAGAZINE™

www.LEGOclub.com



00800 5346 5555*        

  **1-866-534-6258 • 1-877-518-5346**

US & Canada only

Canada seulement

* Freephone. Mobile charges may apply. * Nummer sans Frais. Les Frais peuvent s'appliquer avec les téléphones cellulaires.

* Geländespezifisch. Kosten für Anrufe aus Mobilfunknetzen können abweichen. * Gratis telefonnummer vande vaste lijn. * Telefoonnummer gratis, maar de ringer Prijs kostbetaalbaar.

* Net gratuit, mais du ringer Frais en rest. telefon.



VISIT THE WORLD'S
BIGGEST LEGO® SHOP!

www.LEGOshop.com



WIN LEGO® PRODUCTS

Fill out a survey and you might WIN a cool LEGO product!
NO PURCHASE NECESSARY

Open to all residents where not prohibited
Go to www.nielsen.com/dk/LEGO to fill out a survey for a chance to win a LEGO product.

WIN LEGO® PRODUCTEN

Vul een enquêteformulier in en maak kans op een cool LEGO® product!

Kopen niet nodig
Iedereen uit landen waar geen enquêteverbod geldt mag deelnemen.

Ga naar www.nielsen.com/dk/LEGO, vul een enquêteformulier in en maak kans op een LEGO product.

GEWINNE LEGO® PRODUKTE

Nimm an der Umfrage teil und GEWINNE ein tolles LEGO® Produkt!
Die Teilnahme am Gewinnspiel führt zu keinerlei Kaufverpflichtungen

Teilnahme in allen nicht ausgeschlossenen Ländern möglich
Wir verlosen unter allen Teilnehmern der Umfrage auf www.nielsen.com/dk/LEGO LEGO Produkte.

GAGNE DES PRODUITS LEGO®

Réponds à un questionnaire et tu pourrais GAGNER un produit LEGO® très cool !

Aucune obligation d'achat.
Ouvert à tous les résidents des pays autorisés.
Visite www.nielsen.com/dk/LEGO pour répondre à un questionnaire et avoir une chance de gagner un produit LEGO.

レゴ®製品を「当てよう」

アンケートに記入して、かっこいいレゴ®製品を当てよう！

お買い上げの必要はありません。
禁止されていない限り、すべての皆様にご利用いただけます。

www.nielsen.com/dk/LEGOにアクセスして、アンケートにご記入ください。当選者にはレゴ®製品を差し上げます。

