

BIONICLE®

STRONNIUS



8984



1

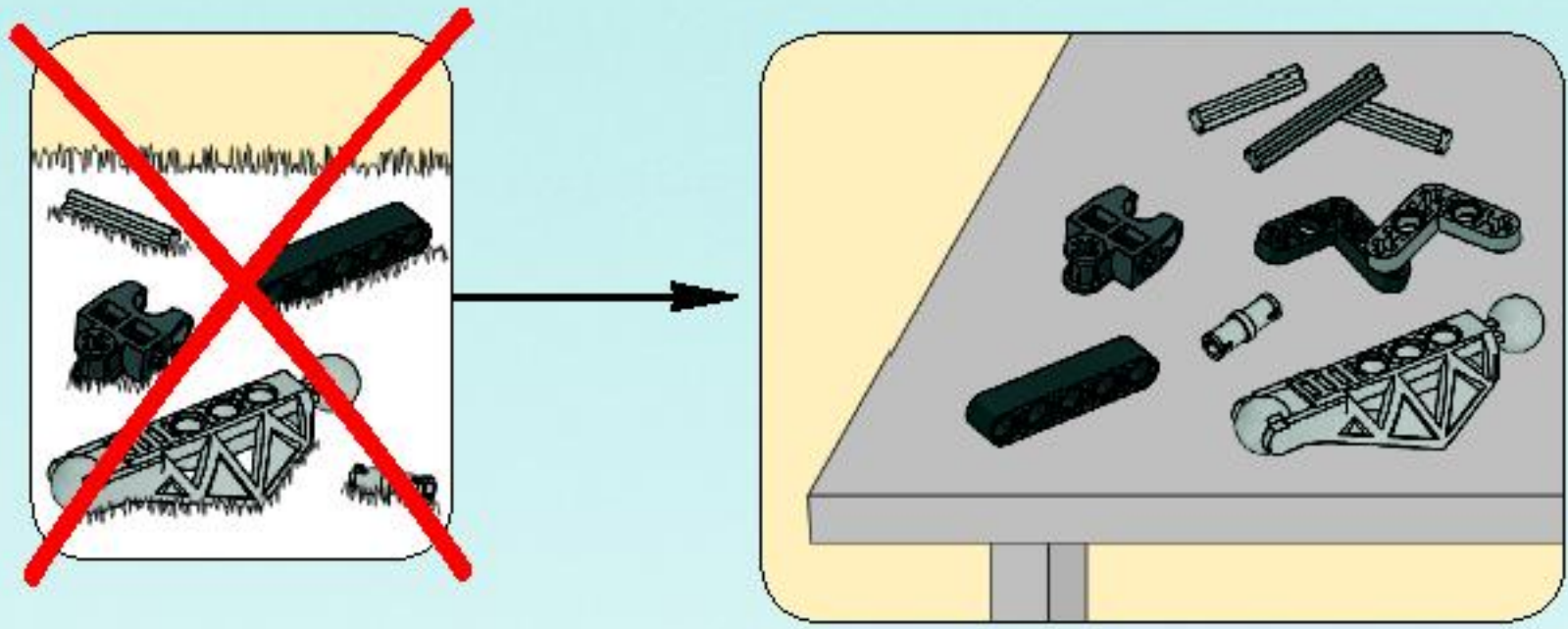

2

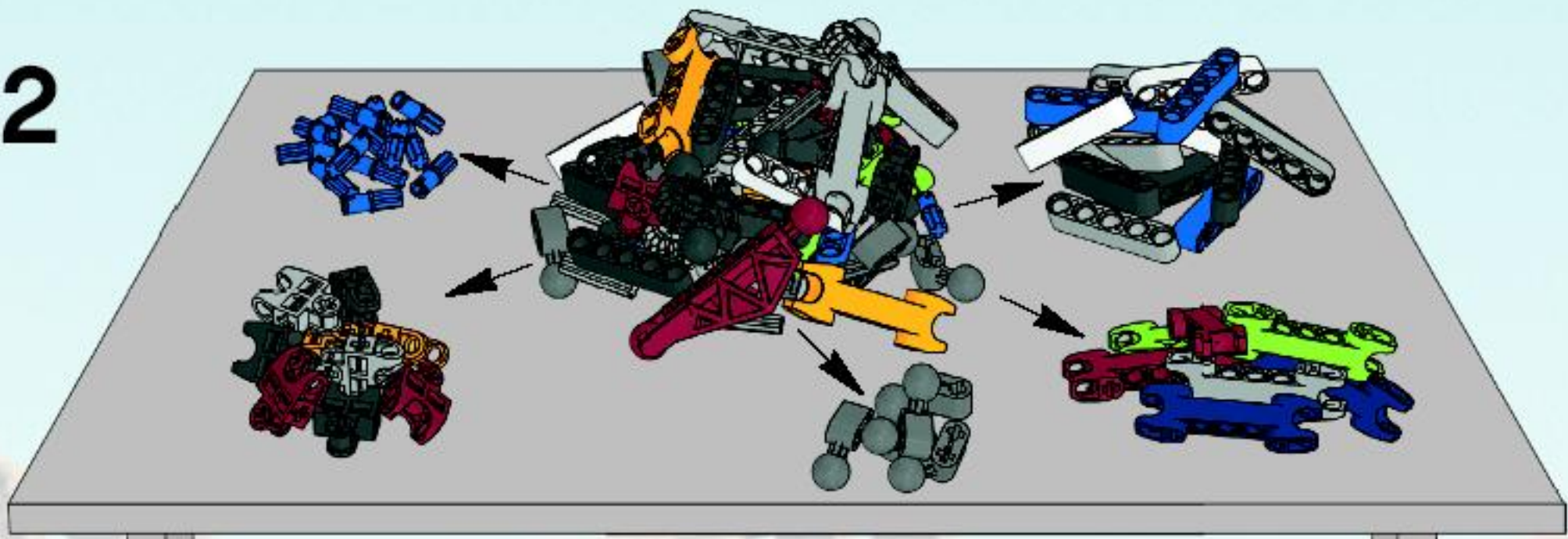

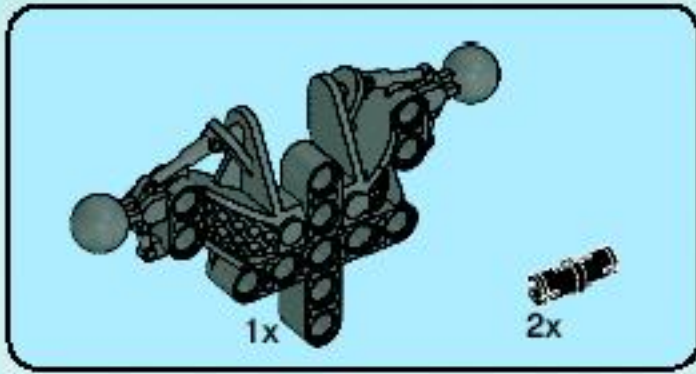

1

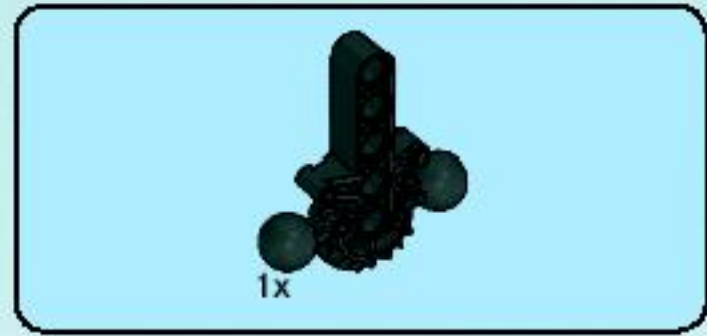
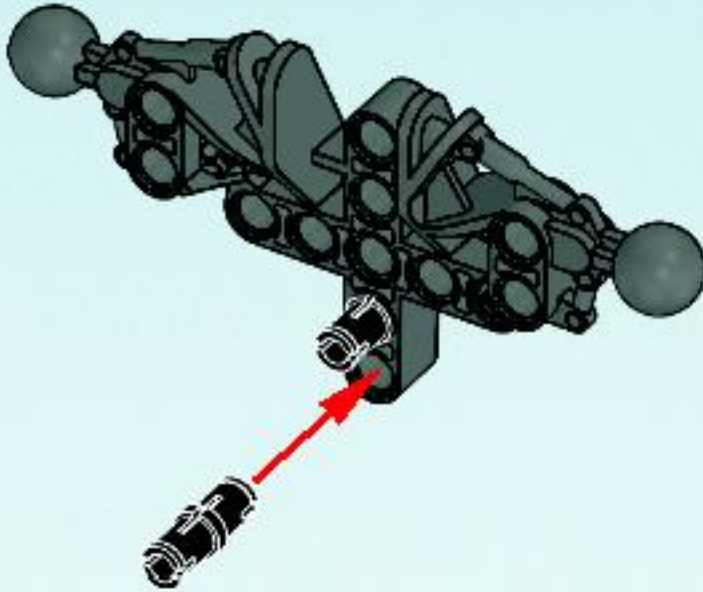

2

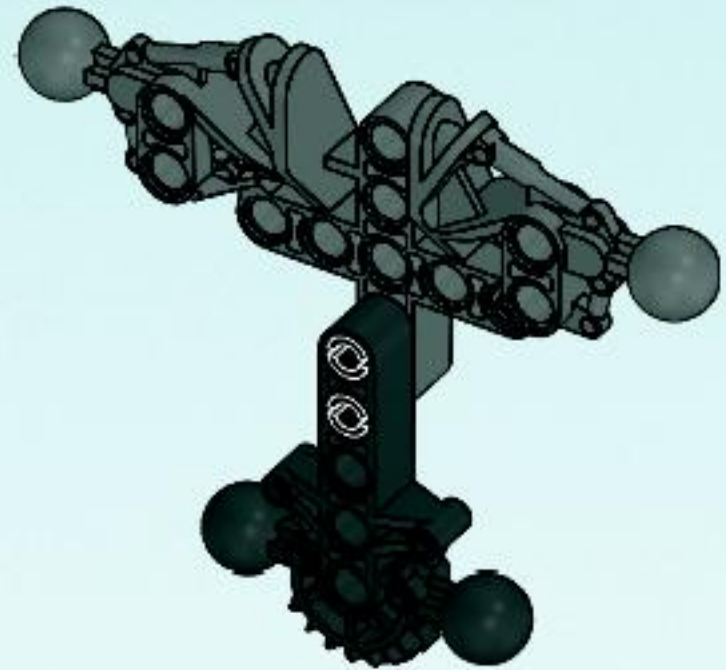

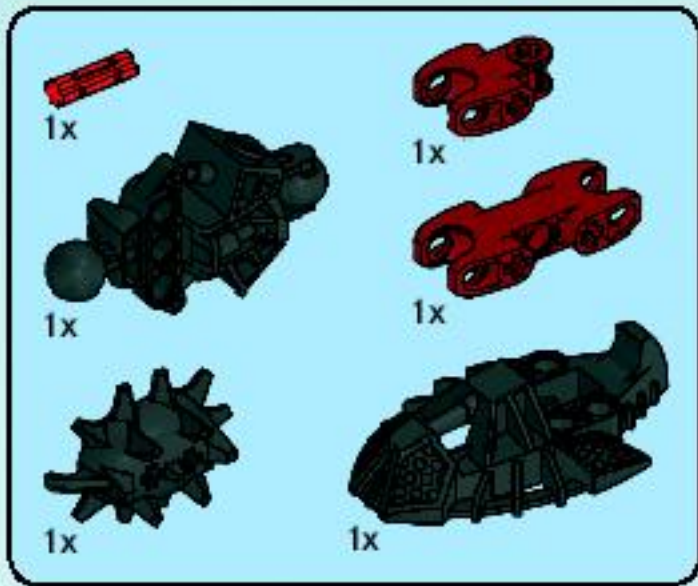
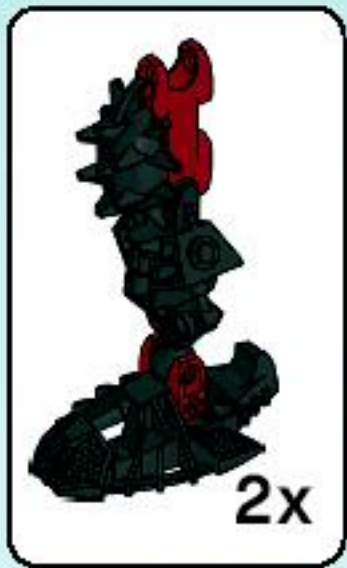

3

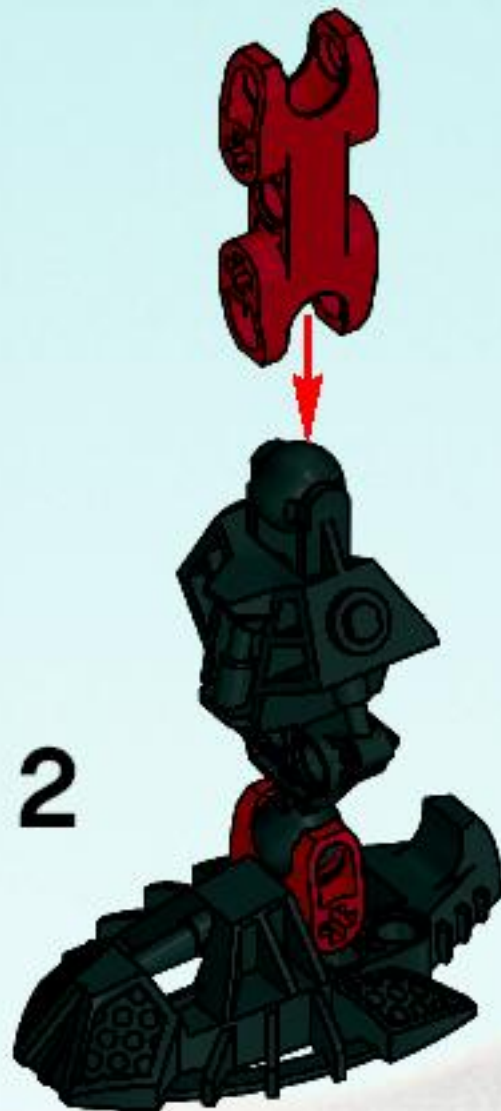

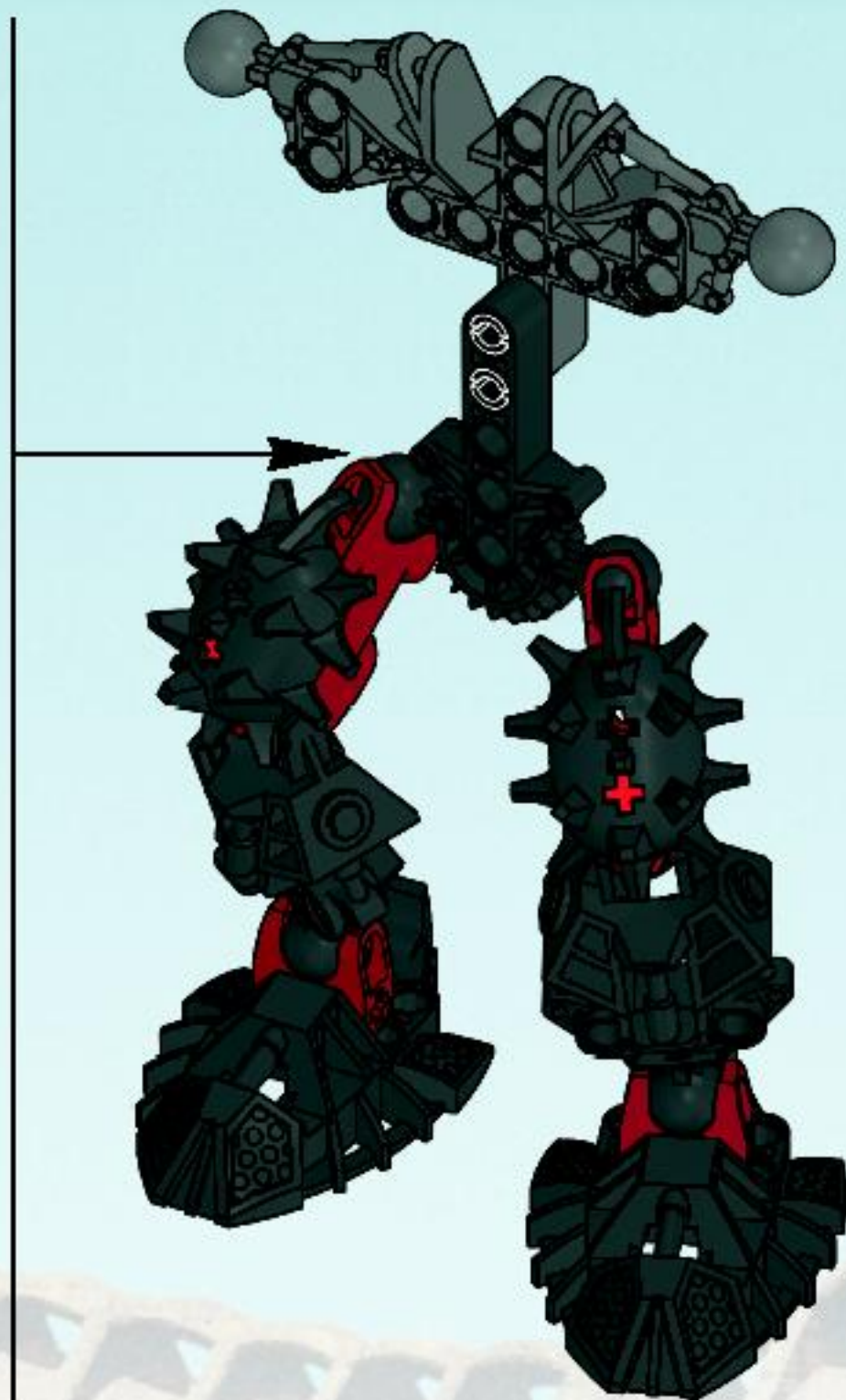
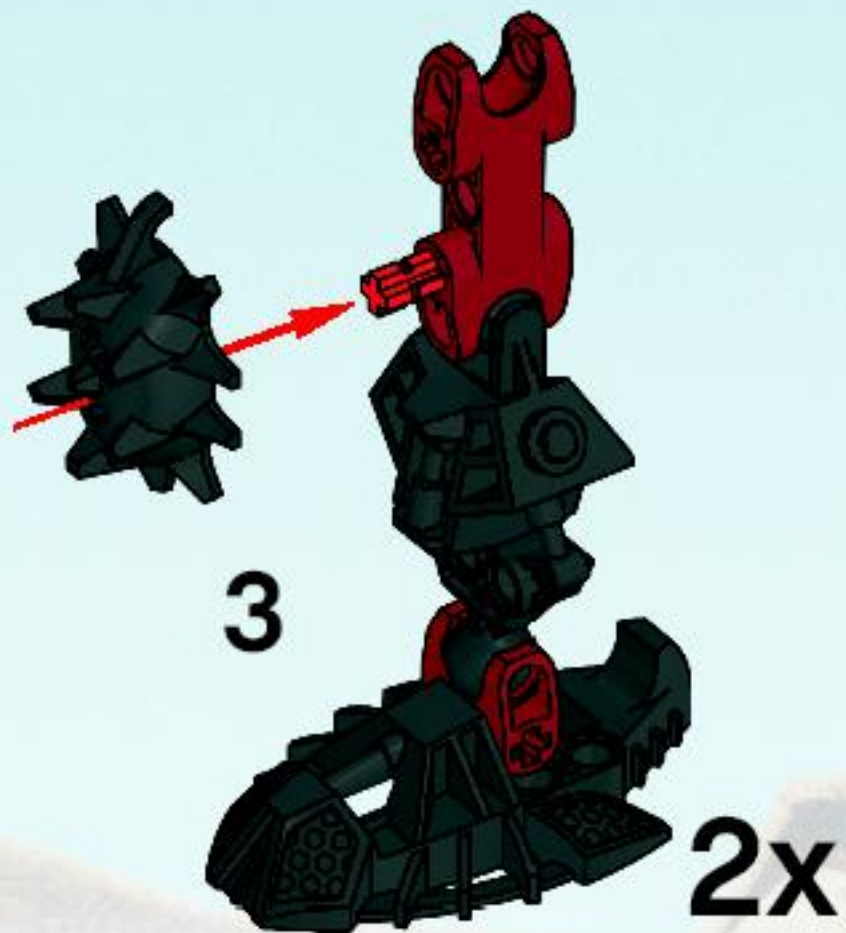

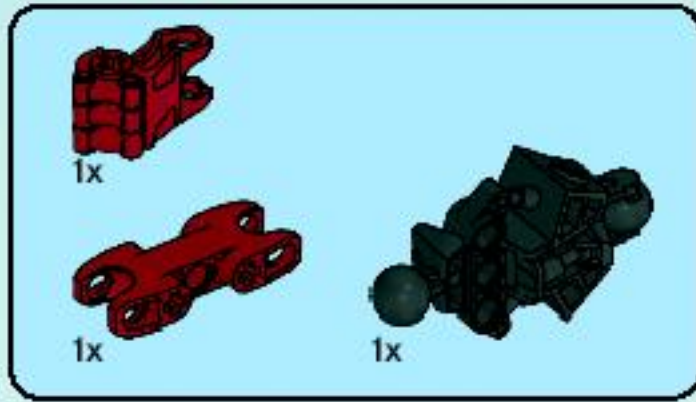

4

1

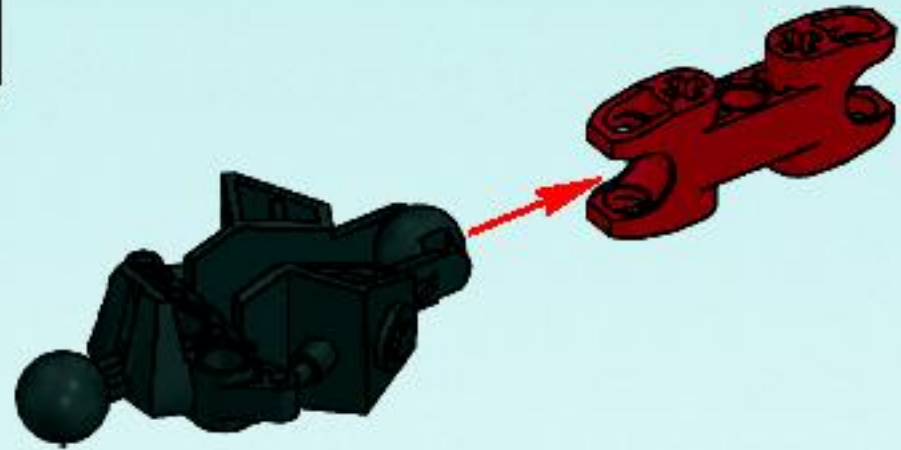

2

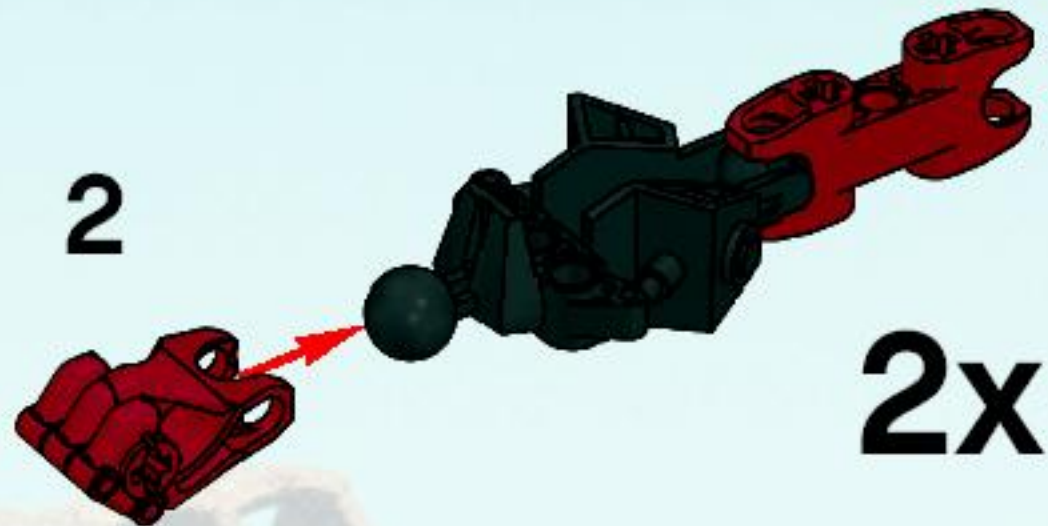

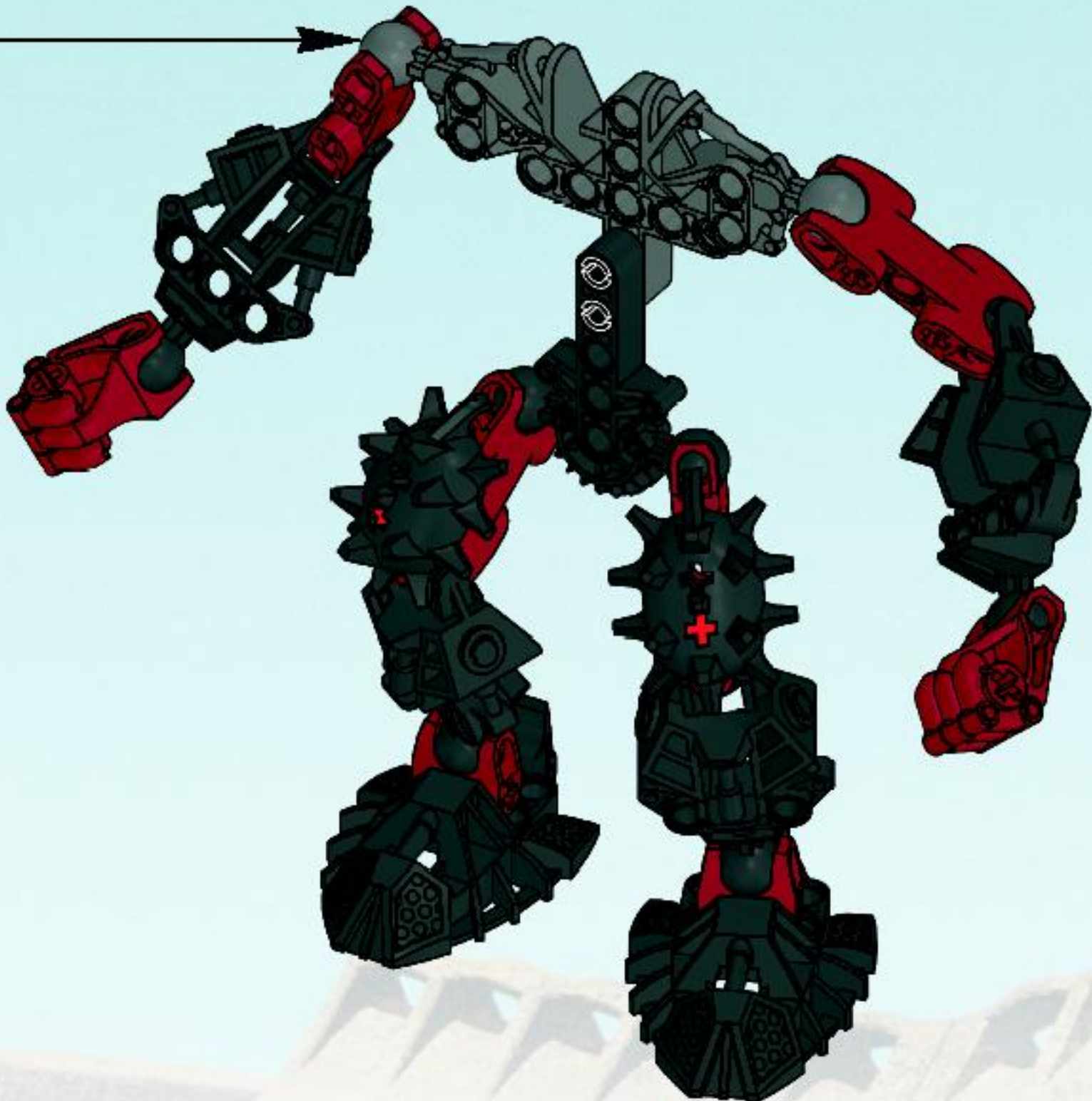

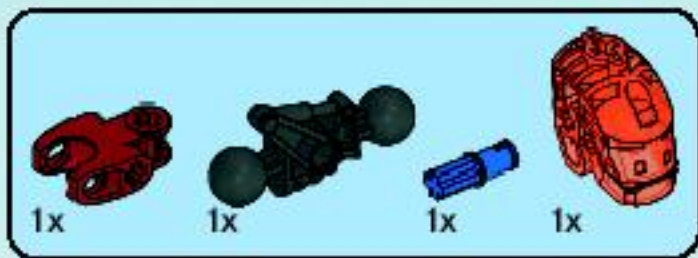

5

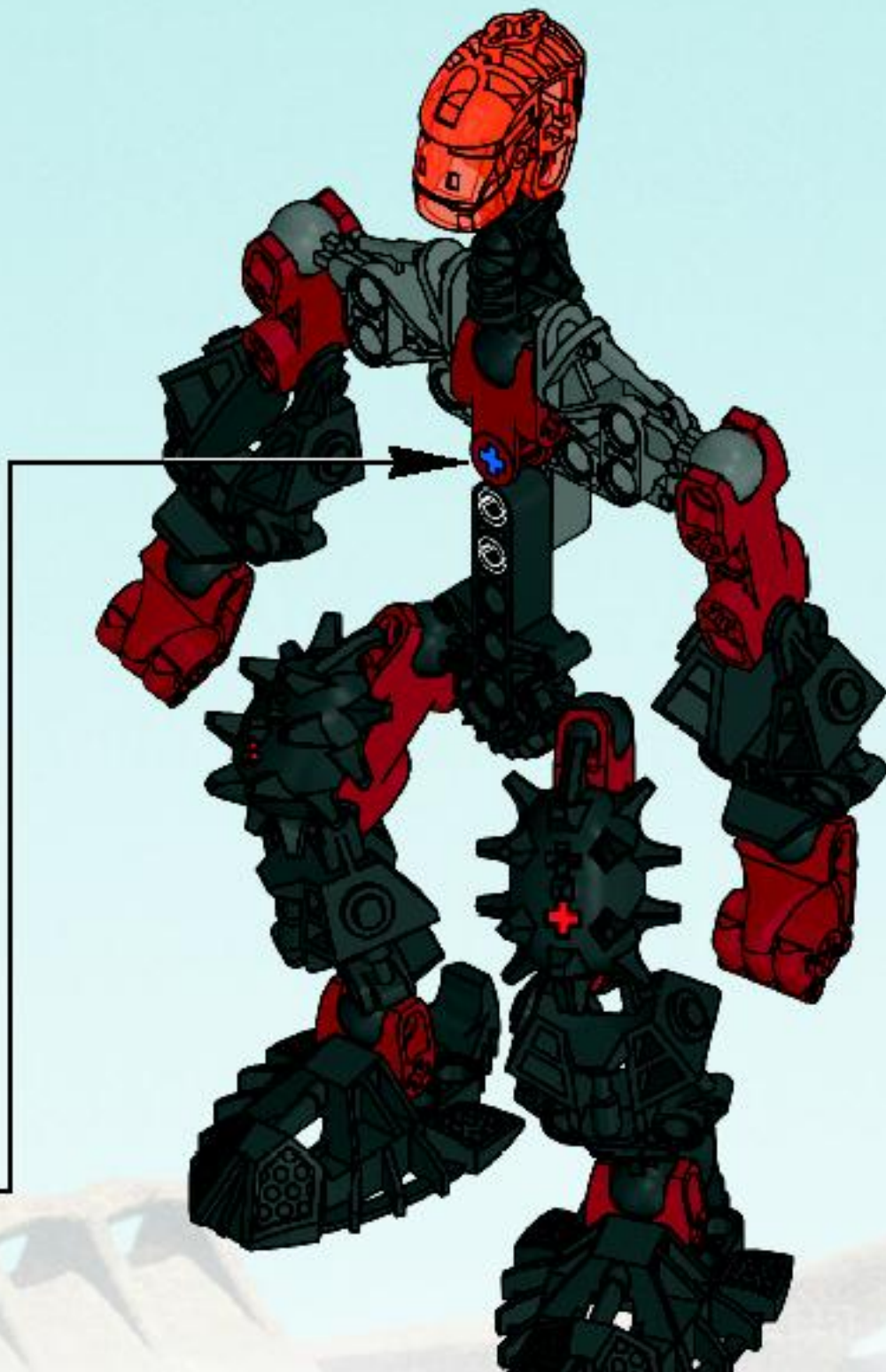
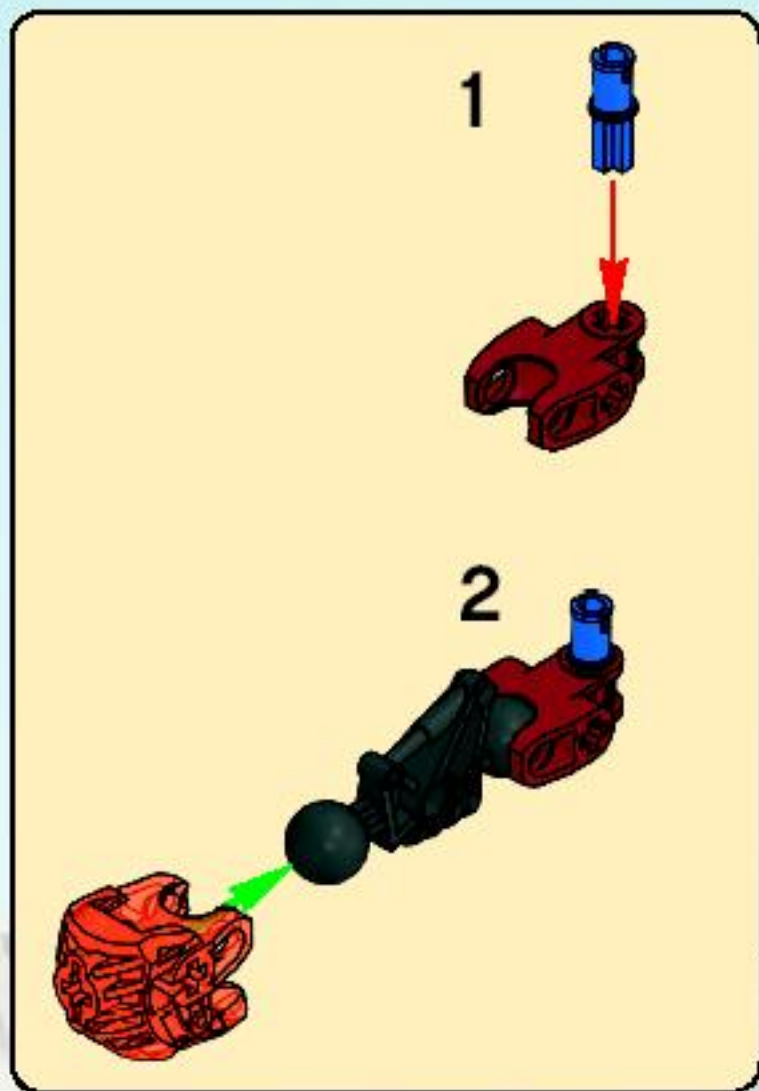

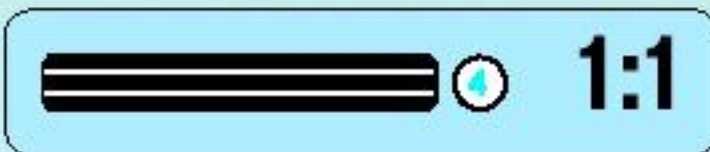
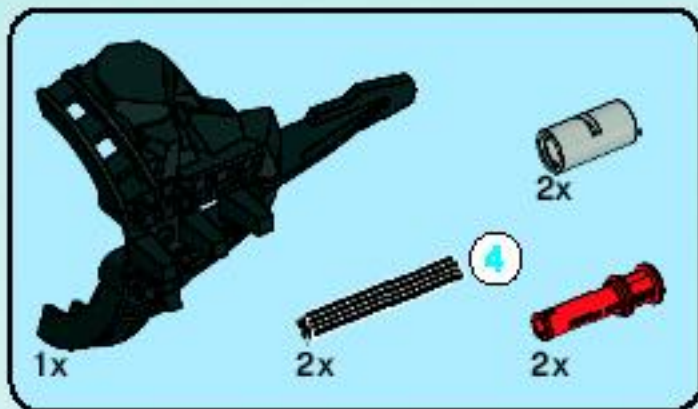

6

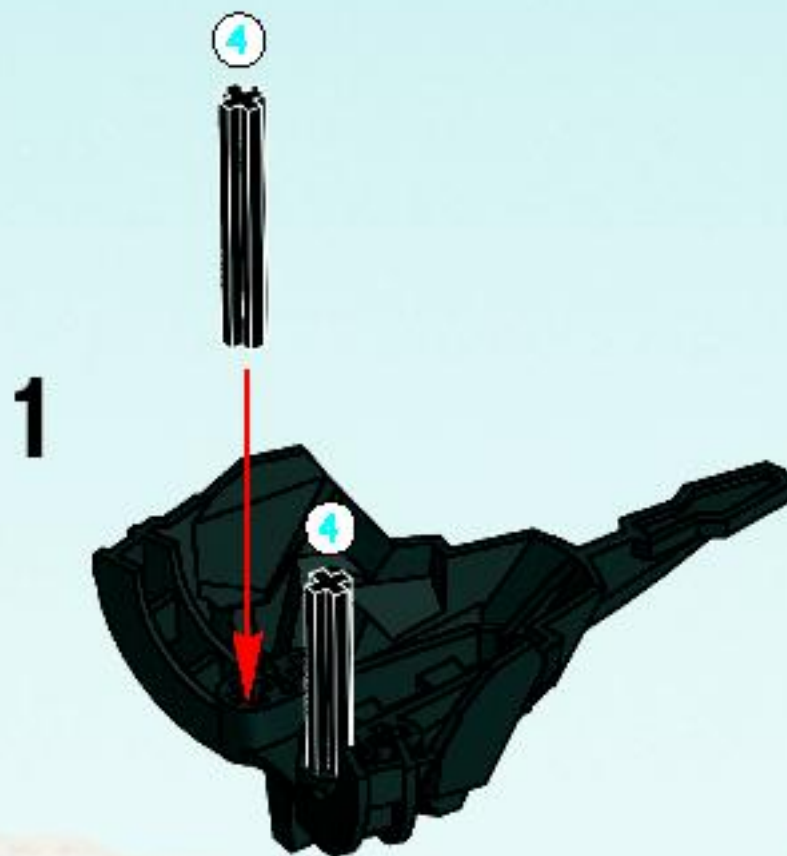

2



3

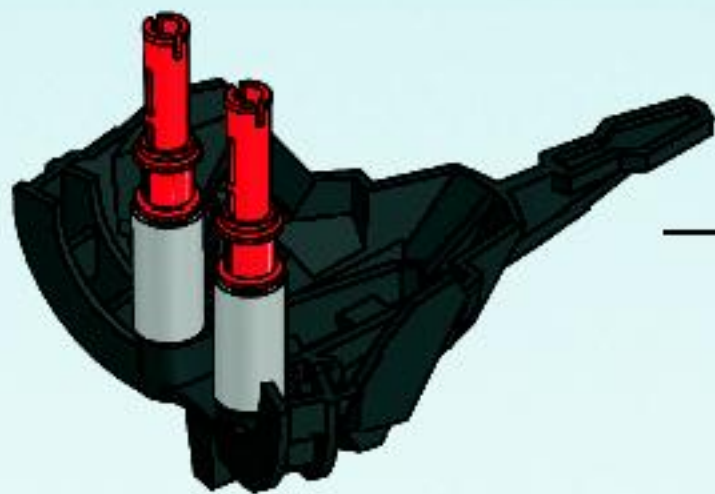

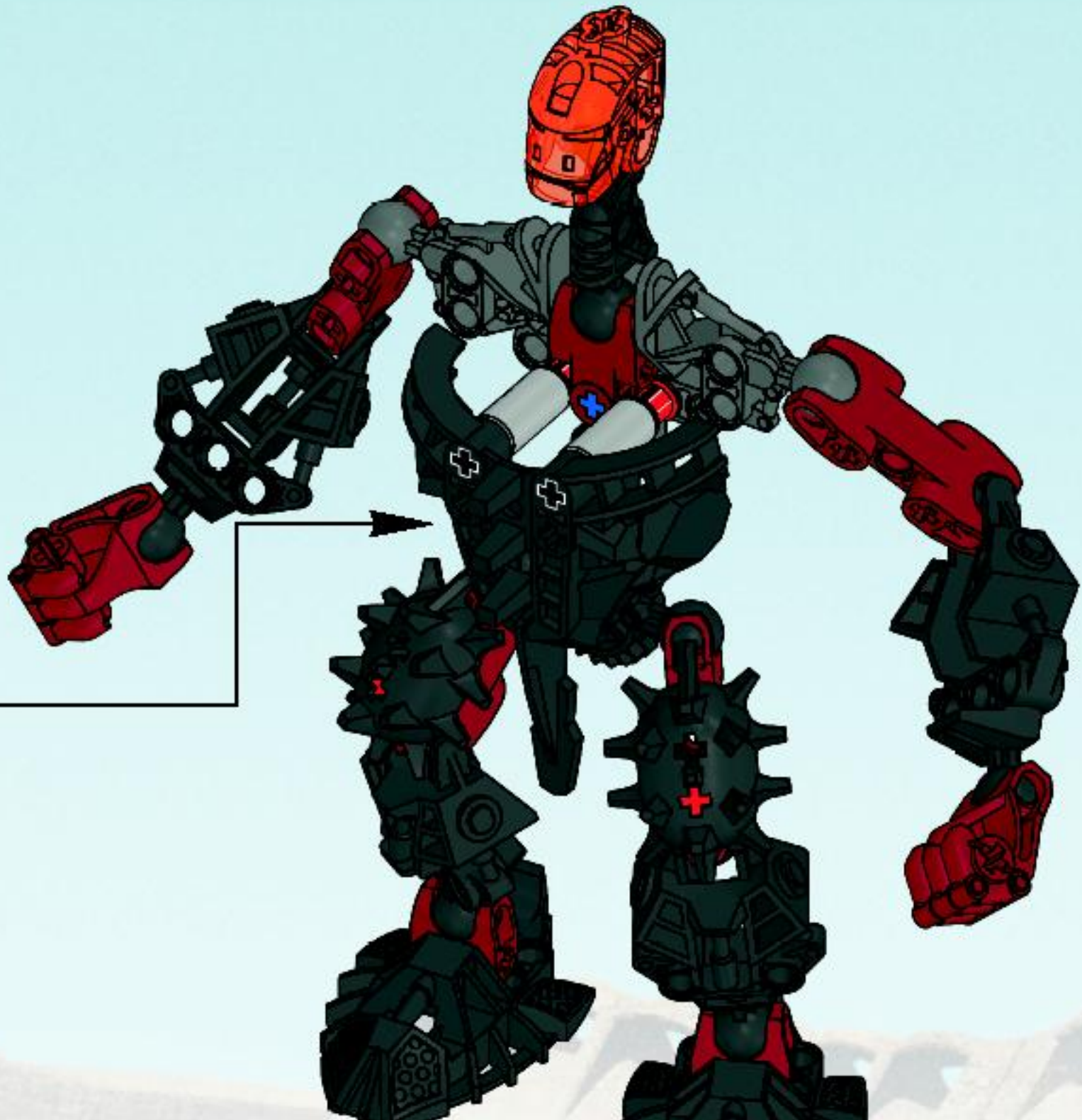



9

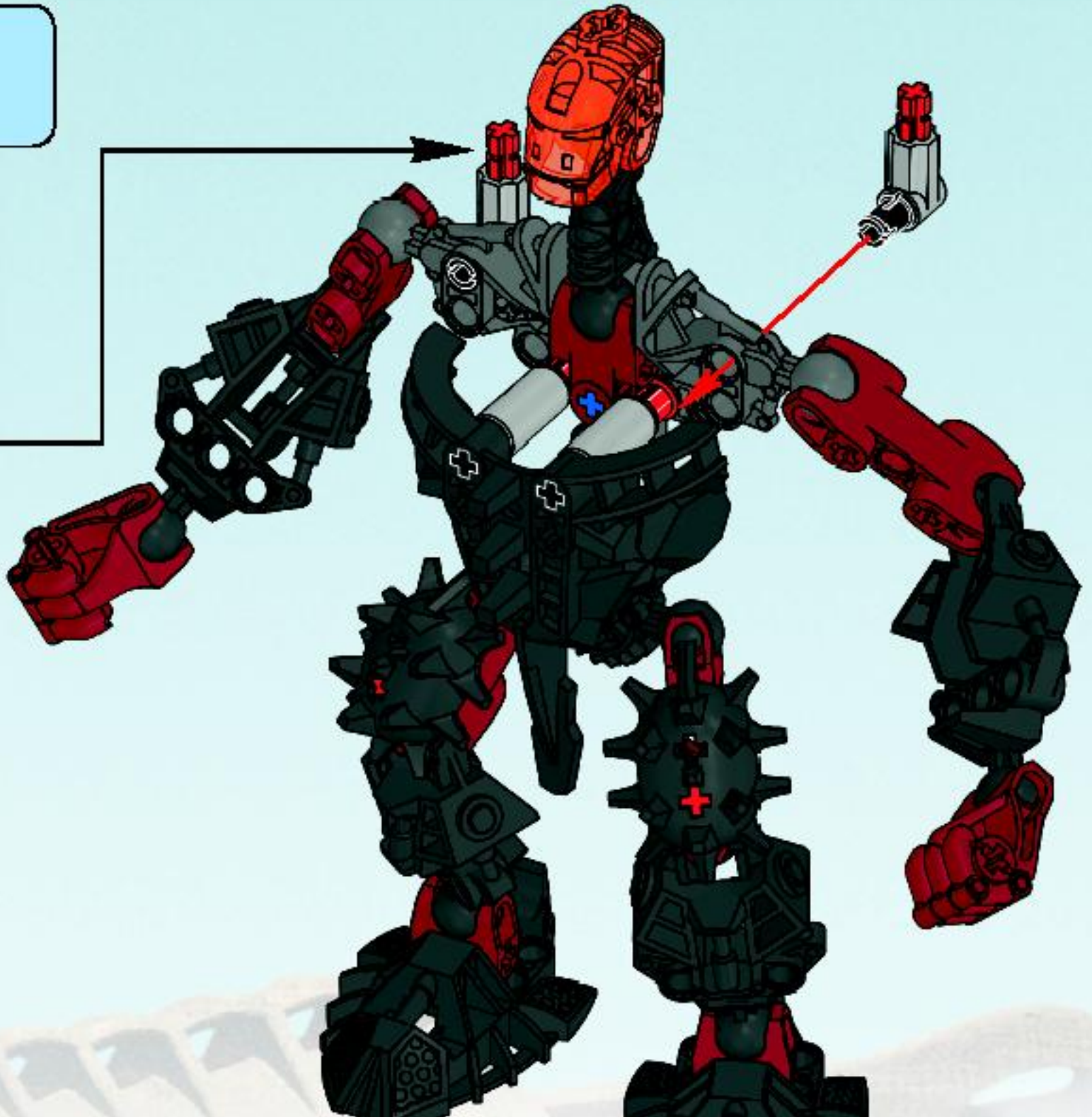
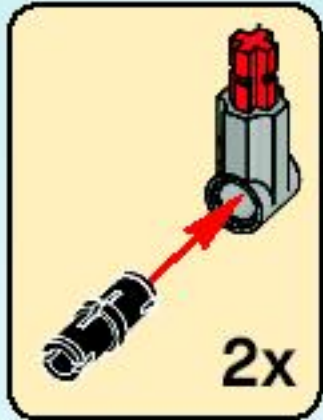

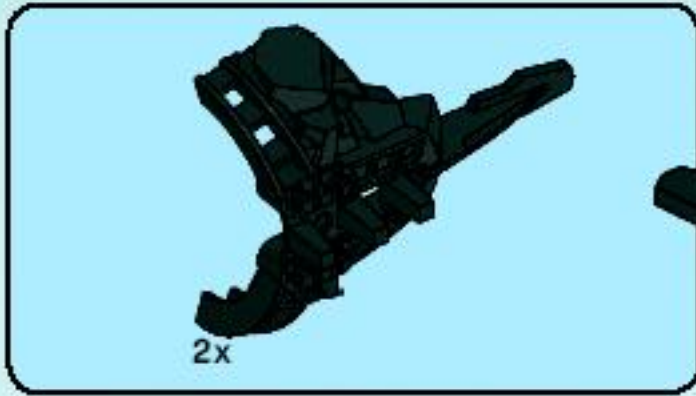

10



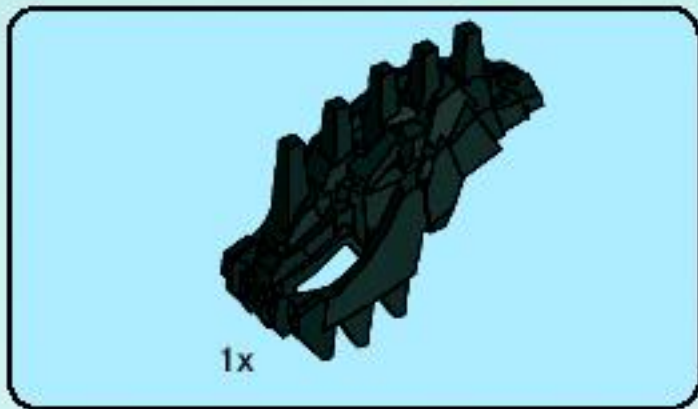

11



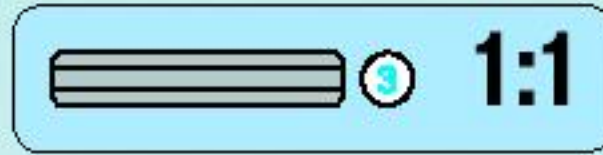
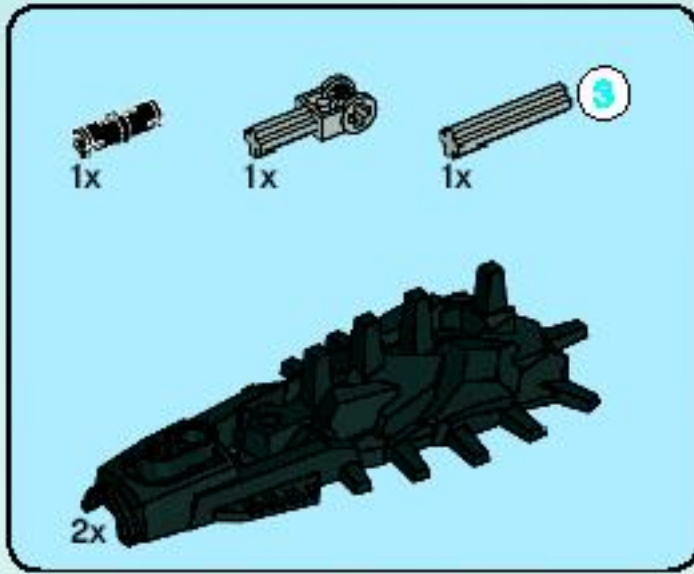

12

1

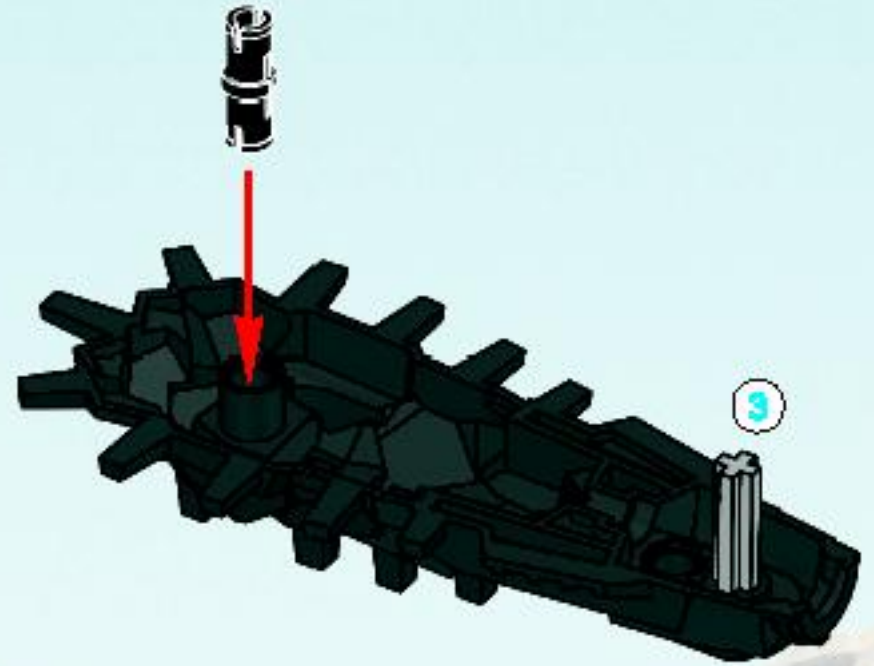

2

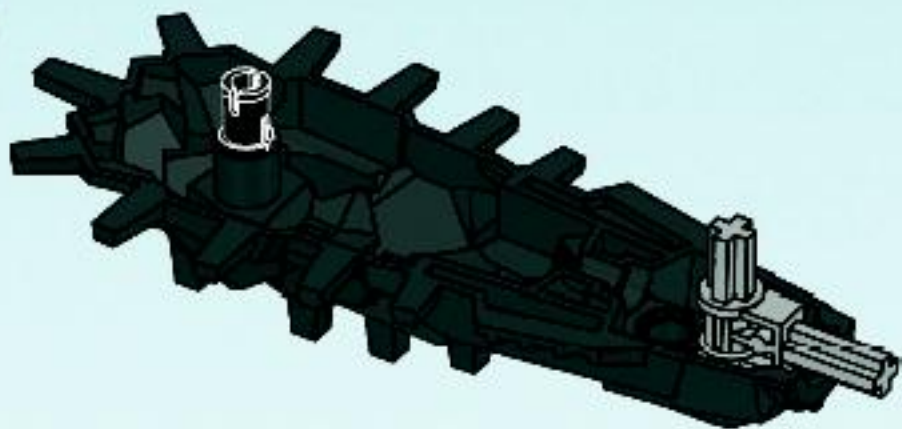

3

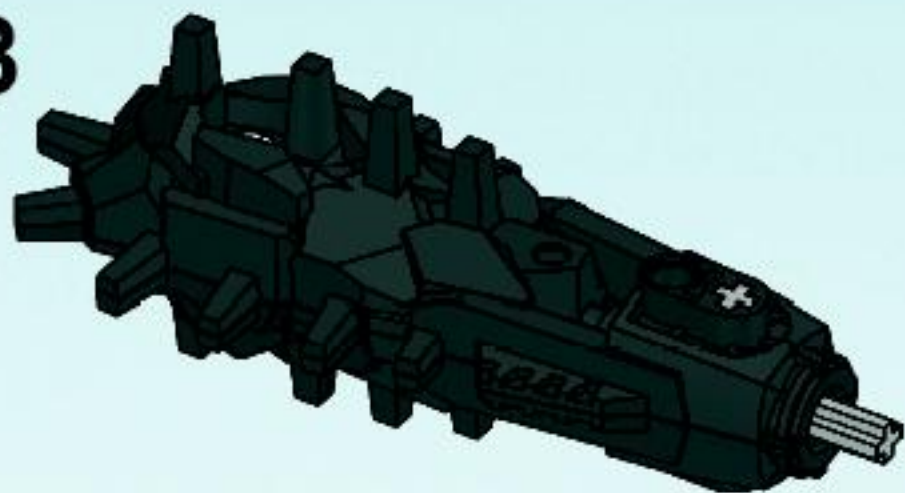



2x



13



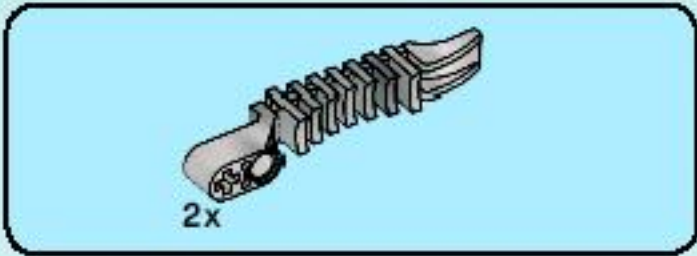

14

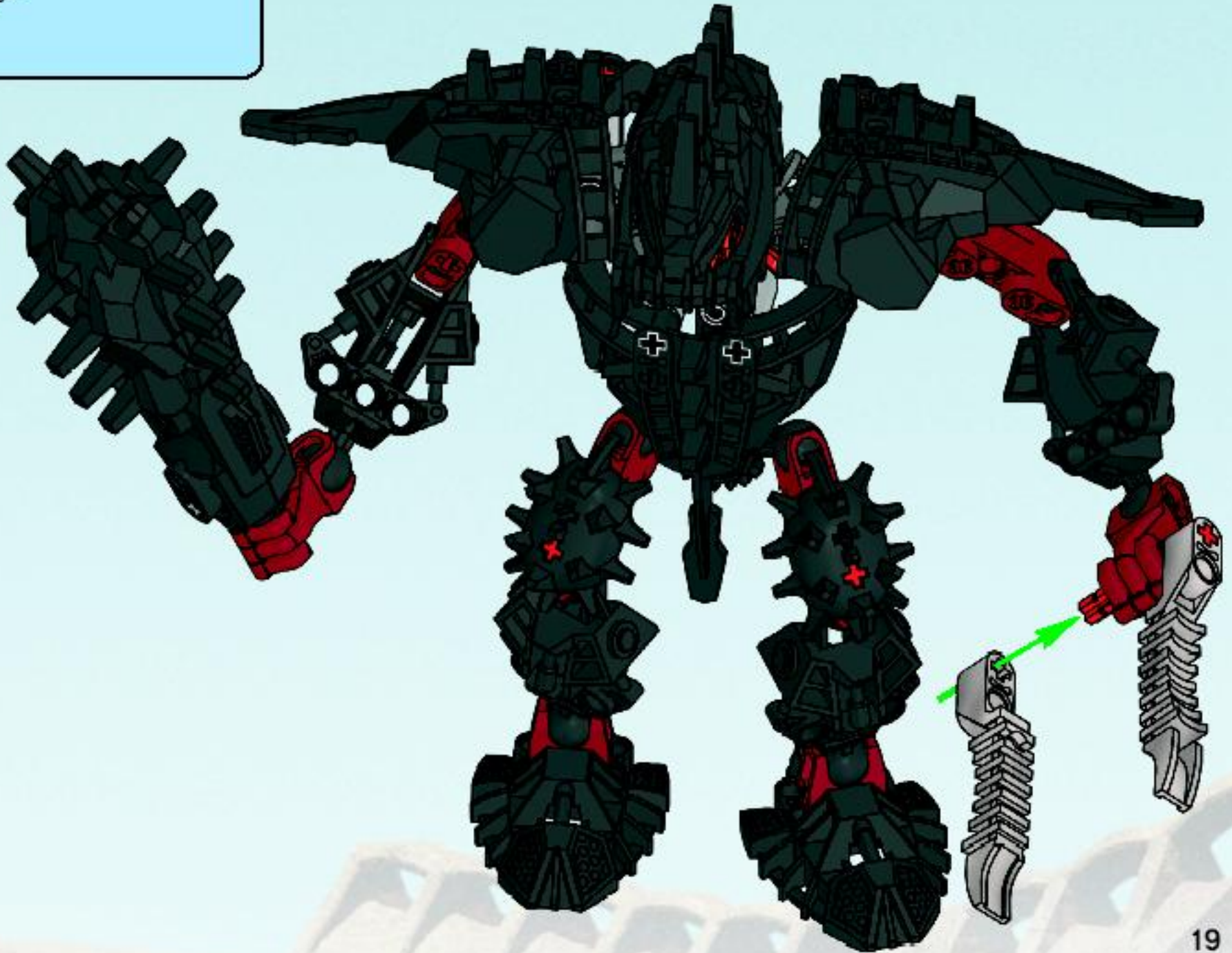



15





16



2x
4206482

1x
4540702

6x
4142865

5x
4121715

1x
4278747

2x
4211550

2x
4546416

2x
4140806

2x
370526

4x
4289376

2x
4526985

1x
4544529

1x
4546585

1x
4278585

1x
4544647

1x
4211536

1x
4211815

1x
4292589

3x
4540569

2x
4291746

3x
4544646

2x
4547364

1x
4540599

4x
4539264

2x
4292528

2x
4544648



Customer Service

Kundenservice

Service Consommateurs

Servicio Al Consumidor

www.lego.com/service or dial



00800 5346 5555 :



1-800-422-5346 :





ALL-NEW MOVIE ON DVD

AUTUMN 2009

BRANDNEUER FILM AUF DVD HERBST 2009
UN TOUT NOUVEAU FILM EN DVD AUTOMNE 2009
UNA PELÍCULA TOTALMENTE NUEVA EN DVD OTOÑO 2009
UM FILME COMPLETAMENTE NOVO EM DVD OUTONO 2009
EGY VADONATÚJ MOZIFILM DVD SZ 2009



UNIVERSAL PICTURES
WWW.UNIVERSALPICTURES.COM

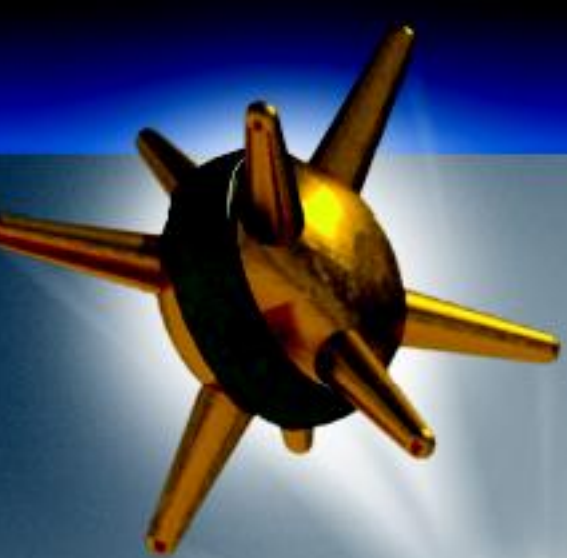

BIONICLE ACTION FIGURE
GAME



Setting Up Aufbau des Spiels

Règles du jeu Comenzar a jugar

This game is about taking the life of your opponent before he takes yours!

1. Set up the game using 2 cans & 2 figures
2. Set the dial to 5
3. Decide who goes first

Treffe Deinen Gegner und nimm ihm die Lebenspunkte, bevor er es tut!

1. Stelle zwei Dosen und zwei Figuren wie abgebildet auf.
2. Drehe die Lebenszähler an den Spielfiguren auf 5.
3. Entscheide, wer beginnt.

Pour remporter le combat, il faut que tu t'empares de la vie de ton adversaire avant qu'il ne s'empare de la tienne !

1. Délimite la zone de combat à l'aide des 2 boîtes et place les 2 figurines
2. Positionne ton compteur de vie sur 5
3. Décide qui commence

¡El objetivo de este juego es hacerse con la vida de tu oponente antes de que él se haga con la tuya!

1. Prepara el juego utilizando 2 botes y 2 figuras
2. Coloca el marcador en 5
3. Decide quién empezará



Playing the game: **POINTS** Punktvergabe bei einem Treffer

Comment jouer : **LE CALCUL DES POINTS**
Como jugar: **PUNTOS**

1. Hit can and opponent loses 1 life point or hit figure and opponent loses 2 points.

1. Wird die Dose getroffen, verliert der Gegner 1 Punkt, bei einem Treffer der Figur werden 2 Punkte abgezogen.

1. Si ta balle Spiky touche la boîte, ton adversaire perd 1 point de vie et si elle touche la figurine, ton adversaire perd 2 points

1. Si golpeas el bote, tu oponente pierde 1 punto y si golpeas la figura, tu oponente pierde dos puntos.



Playing the game: **MOVE**
Position der Spielfiguren

Comment jouer : **LES DÉPLACEMENTS**
Como jugar: **DESPLAZAMIENTO**

1. After shooting move figure to where ball lands.

1. Nach jedem Schuss wird die Figur dort abgestellt, wo die Dornenkugel gelandet ist.

1. Après avoir tiré, déplace la figurine à l'endroit où ta balle Spiky a atterri.

1. Después de disparar, mueve la figura hasta el lugar en el que haya caído la bola.



Winning the game
Gewinne das Spiel

Comment remporter le combat !
Como ganar

- 1. The first player to take all the opponent's life points wins!
- 1. Gewonnen hat der Spieler, der seinem Gegner als Erster alle Lebenspunkte genommen hat.
- 1. Le premier joueur qui s'empare de tous les points de vie de son adversaire gagne !
- 1. ¡El primer jugador que se haya con todos los puntos de vida de su oponente ganará!



For more rules on advanced multi-figure game play - check out



Weitere Informationen und Anleitungen für coole Spiele mit mehreren Figuren findest du unter



Retrouve toutes les règles du jeu multi-joueur sur



Pour plus d'information concernant les règles des jeux de niveau avancé avec plusieurs figurines, visite



Para más información sobre instrucciones de juego avanzado con varias figuras, consulta



Para más información sobre instrucciones de juego avanzado con varias figuras, consulta

www.BIONICLE.com





8996



8995



8992



8993



8994





STRONIUS
8984



ACKAR
8985



VASTUS
8986

GLATORIAN LEGENDS



KIINA
8987



GELLU
8988



MATA NUI
8989

FREE! GRATIS! GRATUIT!



club
MAGAZINE™

www.LEGOclub.com



00800 5346 5555*        

  **1-866-534-6258 • 1-877-518-5346**

US & Canada only

Canada seulement

* FreePhone. Mobile charges may apply. * Numéro sans Frais. Des Frais peuvent s'appliquer avec les téléphones cellulaires.

* Gebührenfrei, Kosten für Anrufe aus Mobilfunknetzen können anfallen. * Gratis telefonnummer van vaste lijn. * Het erett gratis nummer, når du ringer fra fasttelefon.

* Det är gratis, när du ringer från fast telefon.



VISIT THE WORLD'S
BIGGEST LEGO® SHOP!

www.LEGOshop.com



WIN LEGO® PRODUCTS

Fill out a survey and you might WIN a cool LEGO product!
NO PURCHASE NECESSARY
Open to all residents where not prohibited
Go to www.nielsen.com/LEGO to fill out a survey for a chance to win a LEGO product.

WIN LEGO® PRODUCTEN

Vul een enquêteformulier in en maak kans op een cool LEGO® product!
Kopen niet nodig
Iedereen uit landen waar geen enquêteverbod geldt mag deelnemen.
Ga naar www.nielsen.nl/mkl/LEGO, vul een enquêteformulier in en maak kans op een LEGO product.

GEWINNE LEGO® PRODUKTE

Nimm an der Umfrage teil und GEWINNE ein tolles LEGO® Produkt!
Die Teilnahme am Gewinnspiel führt zu keinerlei Kaufverpflichtungen.
Teilnahme in allen nicht ausgeschlossenen Ländern möglich.
Wir verlosen unter allen Teilnehmern der Umfrage auf www.nielsen.nl/mkl/LEGO LEGO Produkte.

GAGNE DES PRODUITS LEGO®

Réponds à un questionnaire et tu pourrais GAGNER un produit LEGO® très cool !
Aucune obligation d'achat.
Ouvert à tous les résidents des pays autorisés.
Visite www.nielsen.nl/mkl/LEGO pour répondre à un questionnaire et avoir une chance de gagner un produit LEGO.

レゴ®製品を「当てよう」

アンケートに記入して、カッコいいレゴ®製品を当てよう！
お買い上げの必要はありません。
禁止されていない限り、すべての皆様にご利用いただけます。
www.nielsen.nl/mkl/LEGOにアクセスして、アンケートにご記入ください。当選者にはレゴ®製品を差し上げます。

