



CITY

7734



3+4+5



**WARNING: CHOKING HAZARD.**  
Small parts. Not for children under 3 years.

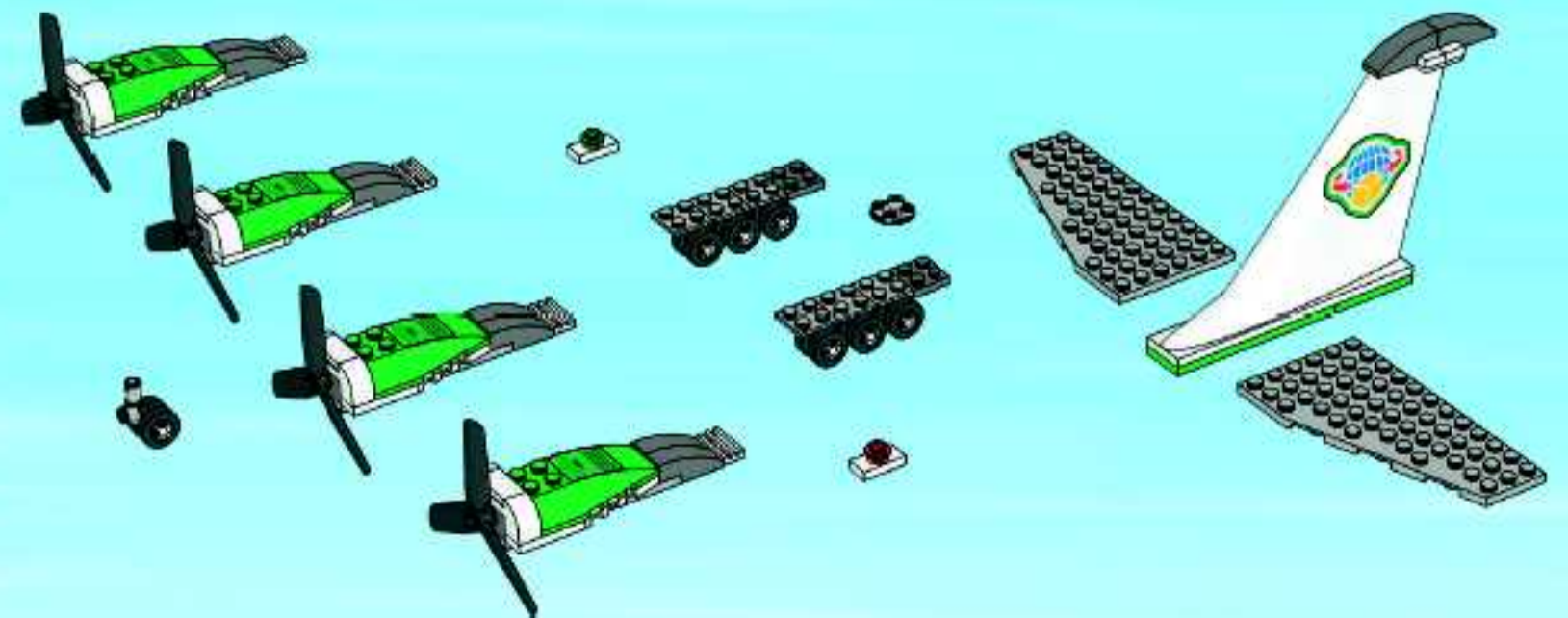
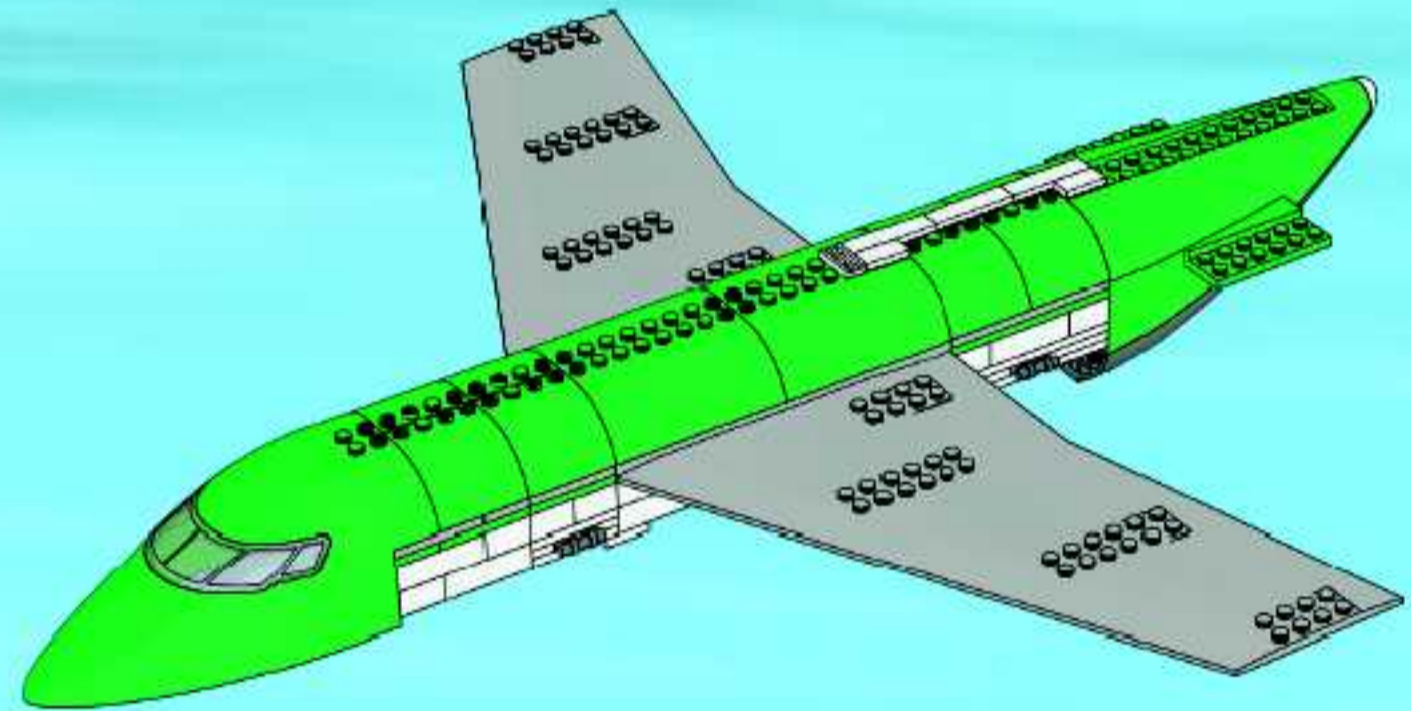
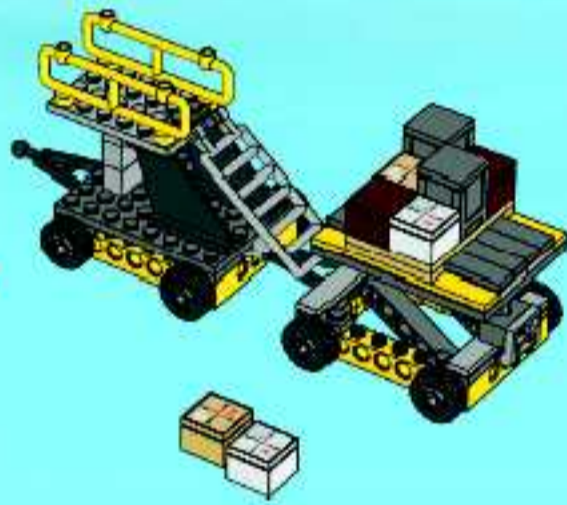
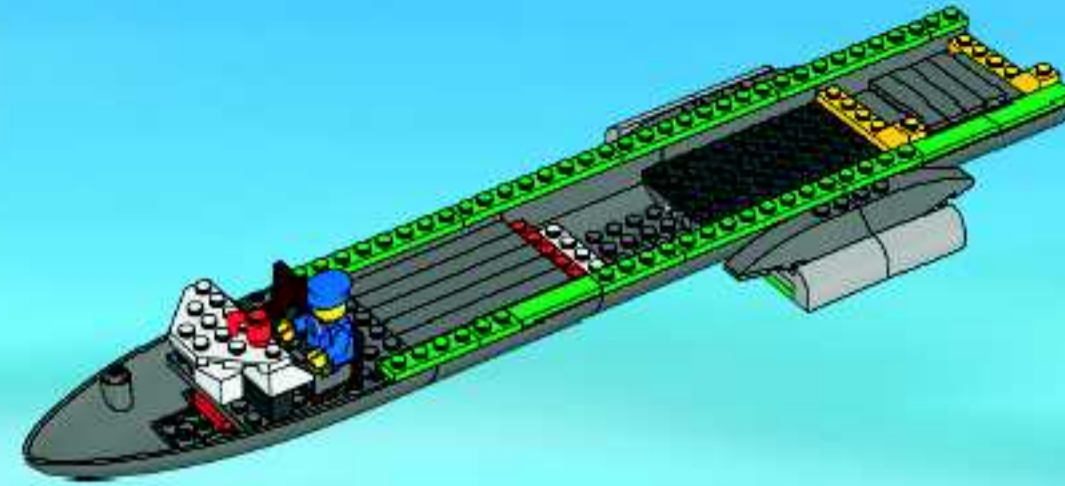

1

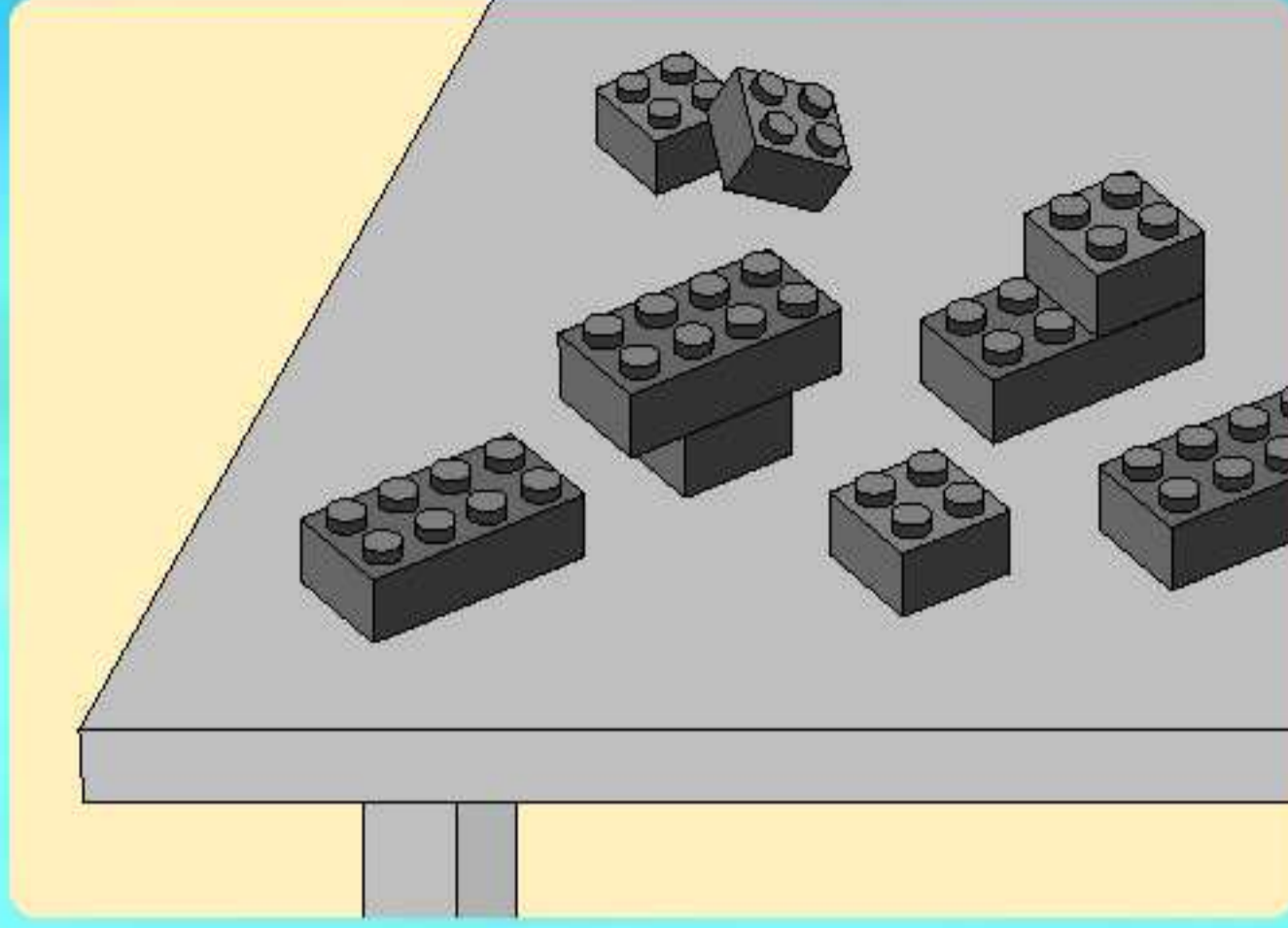
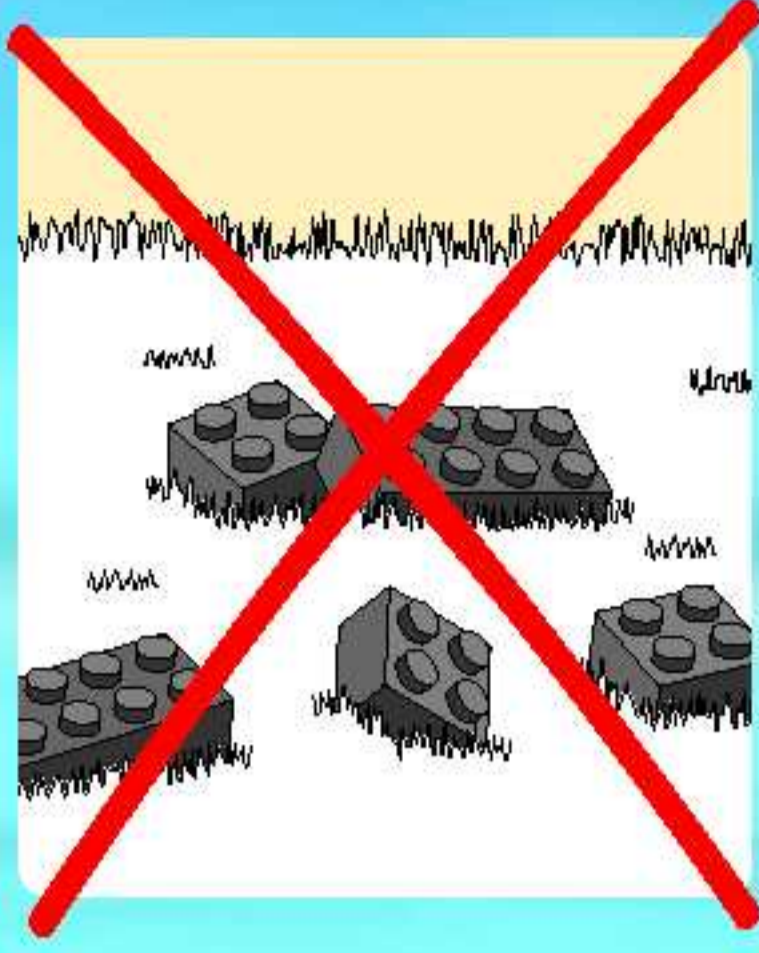

2



 **AVERTISSEMENT : RISQUE D'ÉTOUFFEMENT.**  
Contient des petites pièces. Ne convient pas aux enfants de moins de 3 ans.

 **ADVERTENCIA: PELIGRO DE ASFIXIA.**  
No recomendado para niños menores de 3 años. Contiene piezas pequeñas.

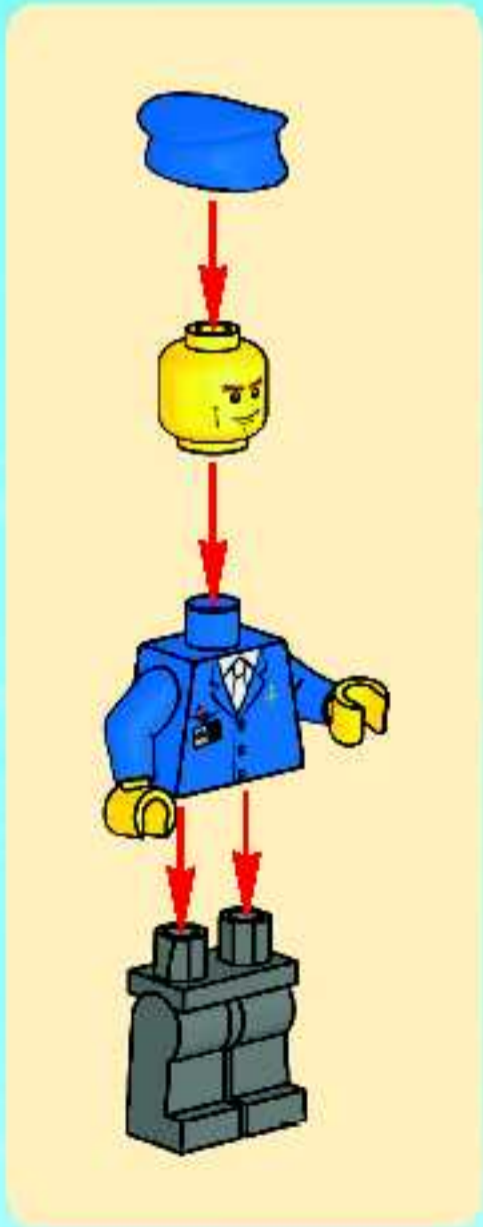
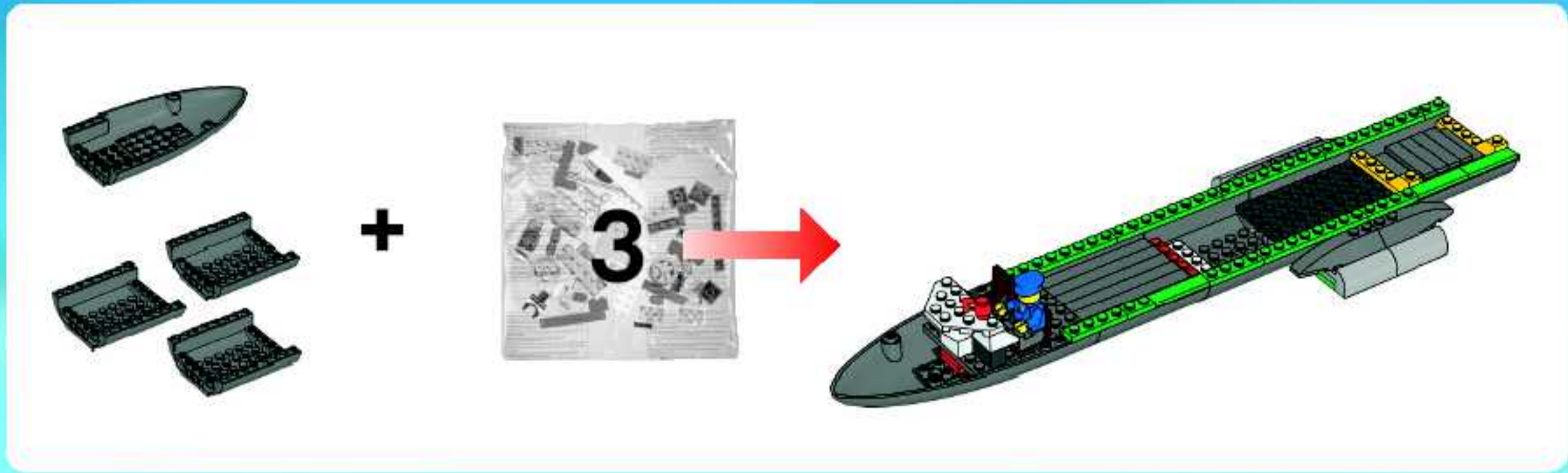

1

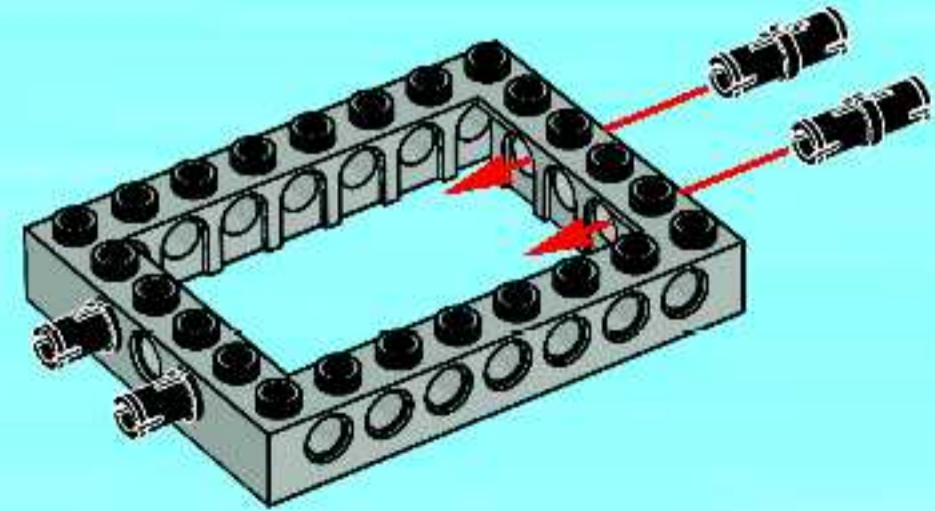

2

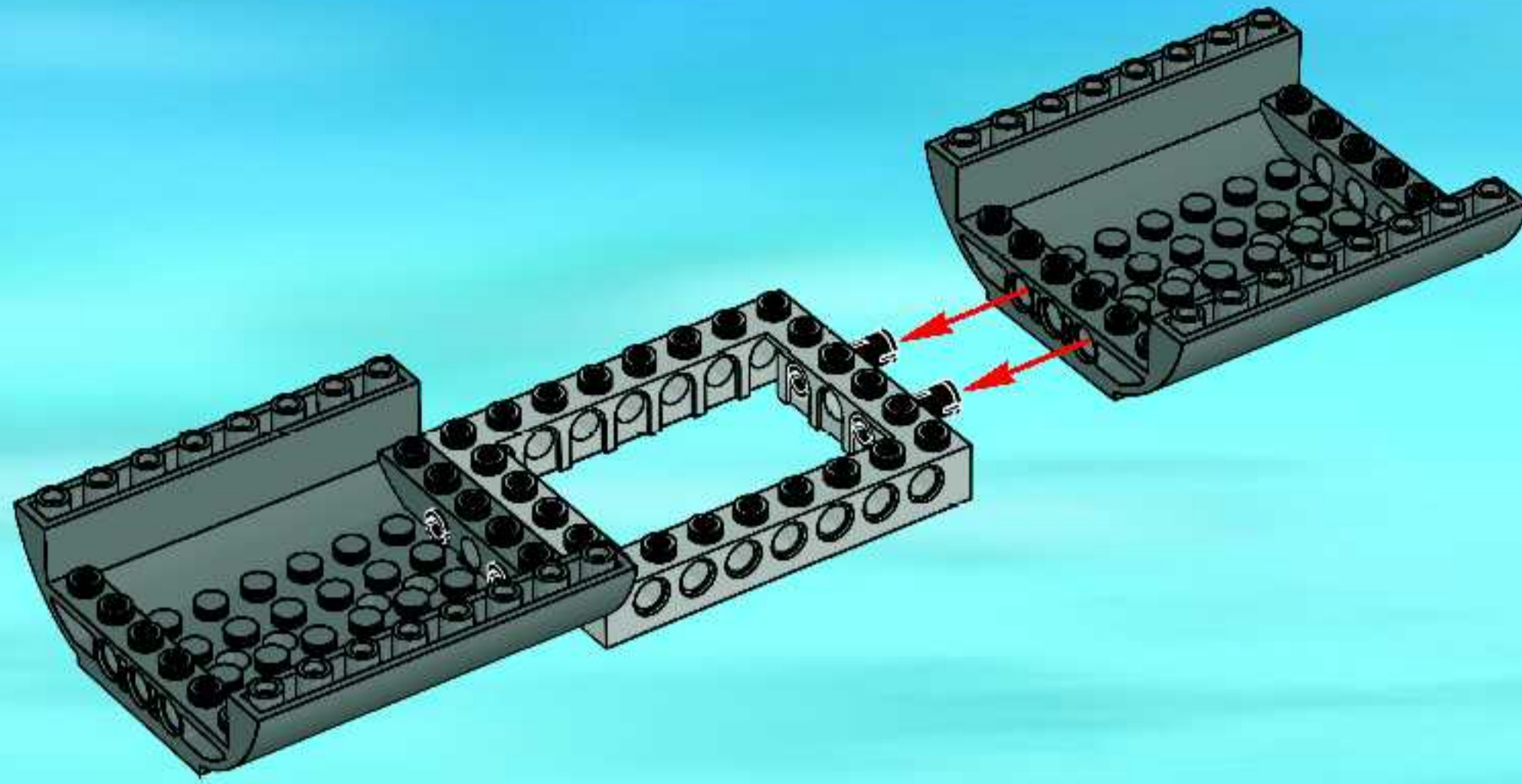

3

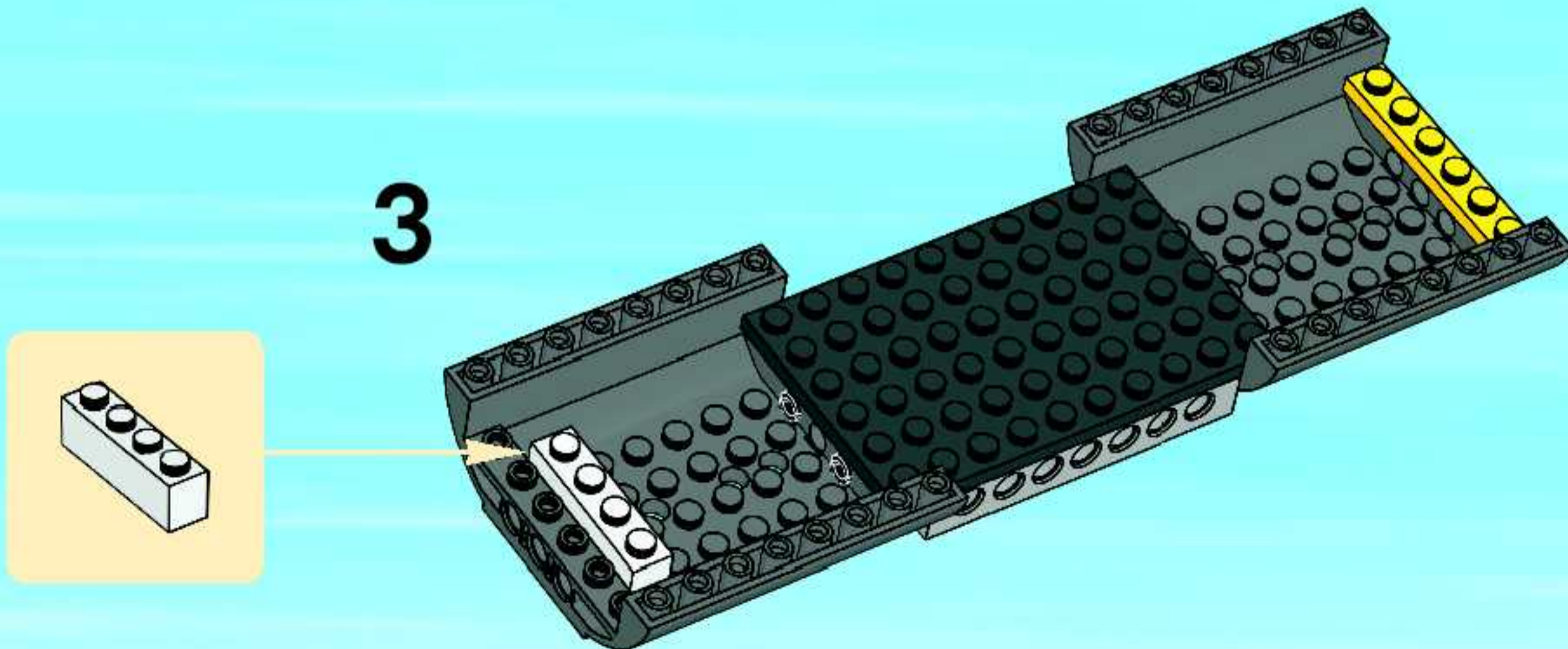

4

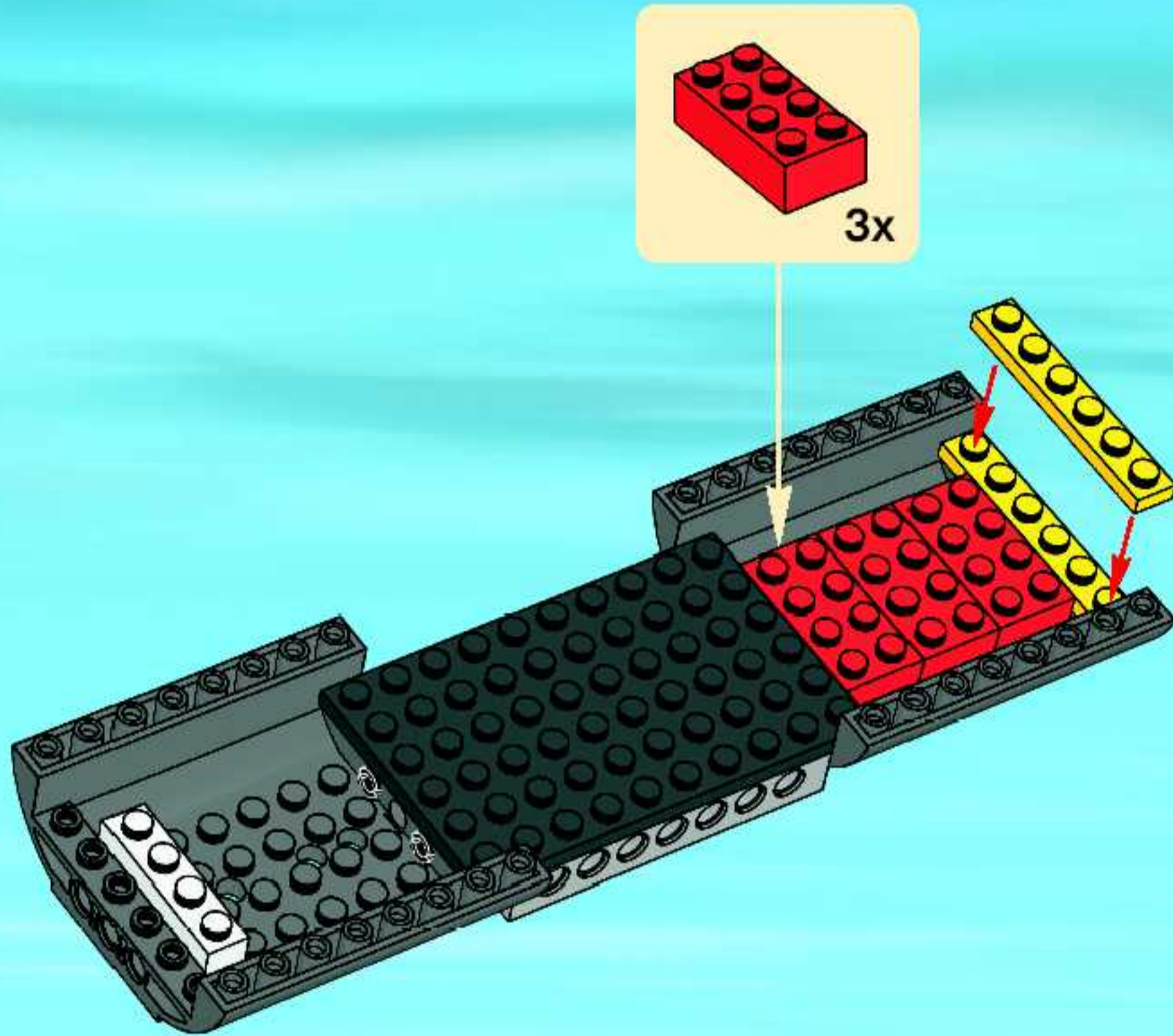

5

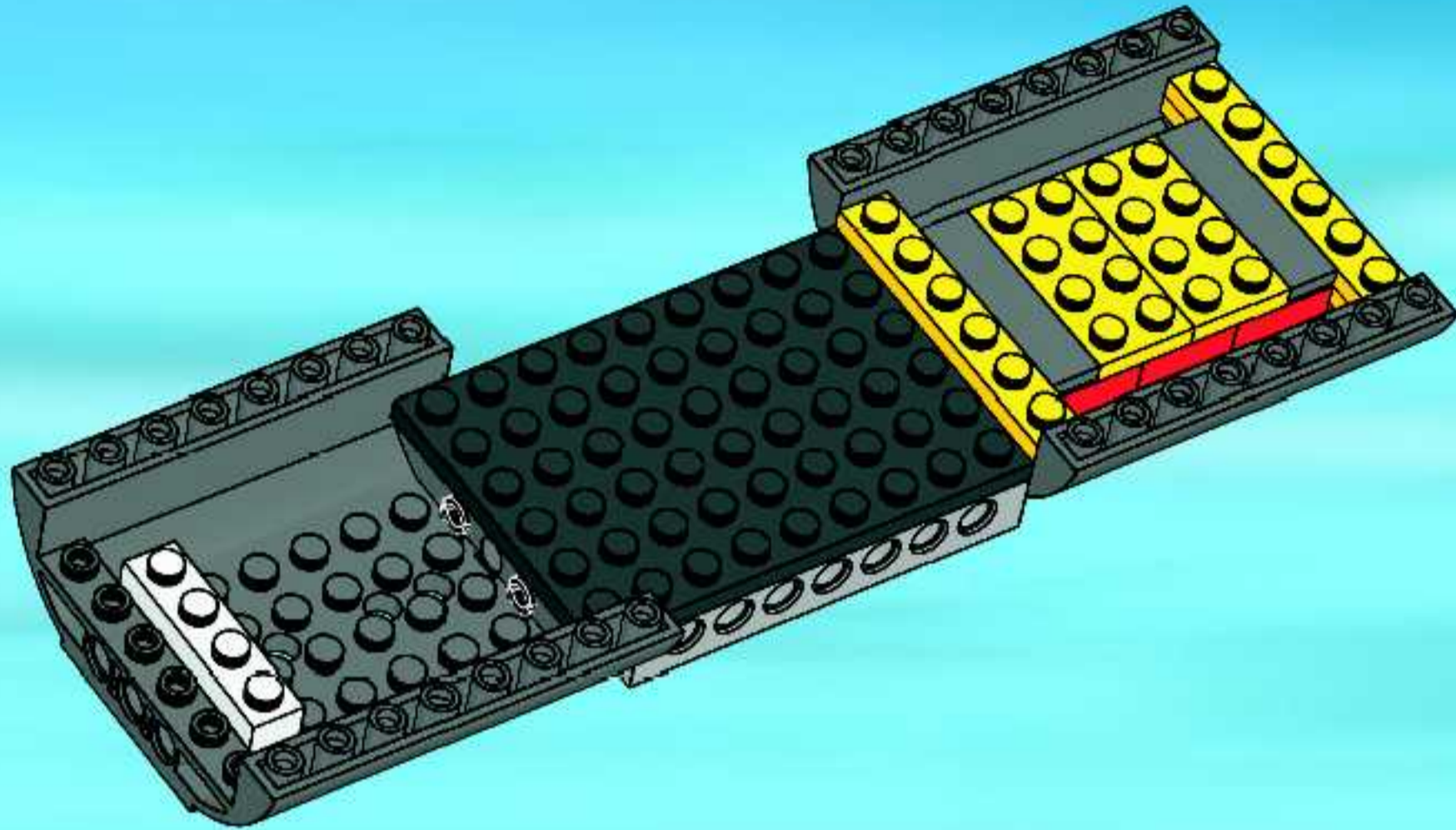

6

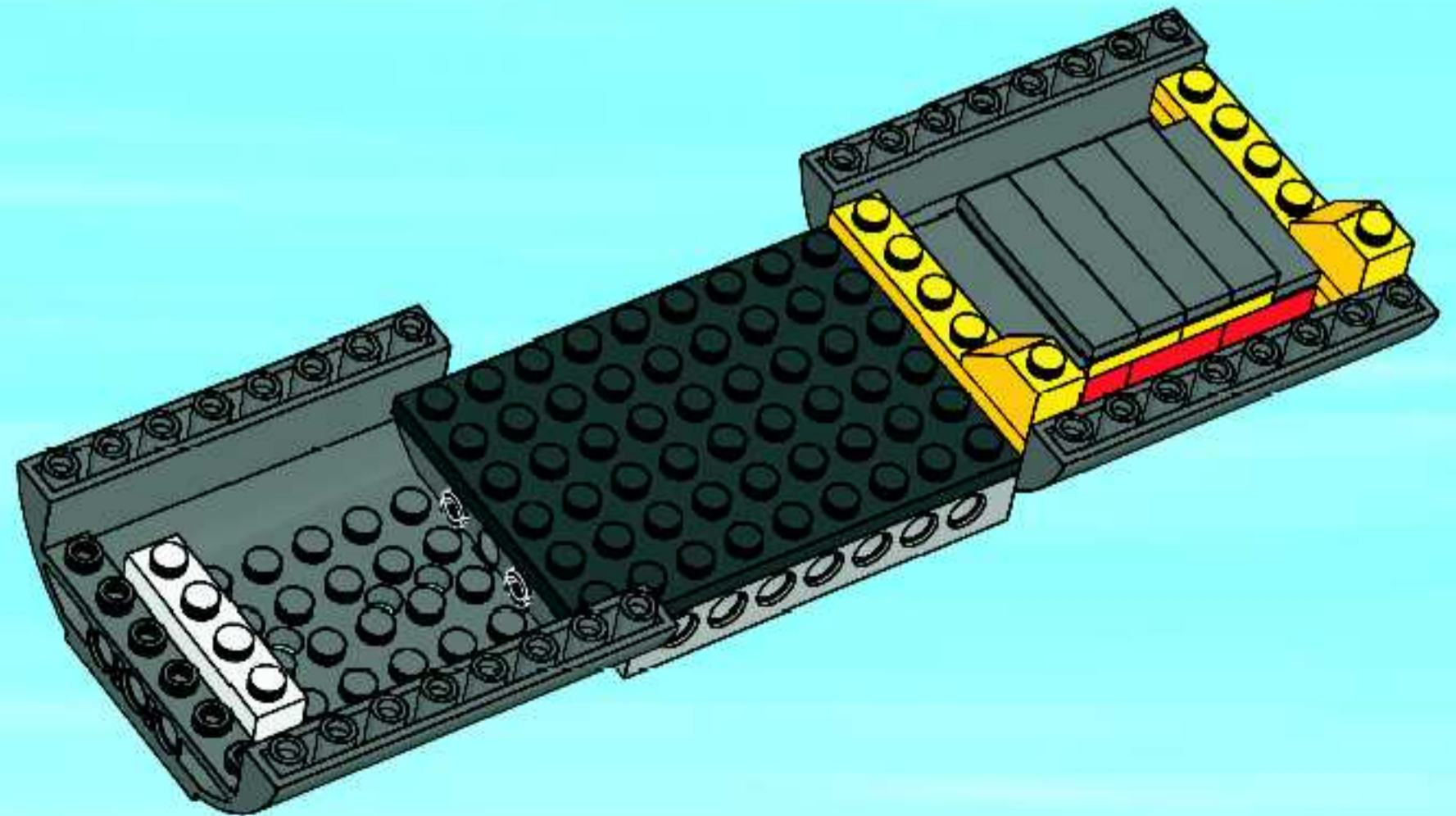

1

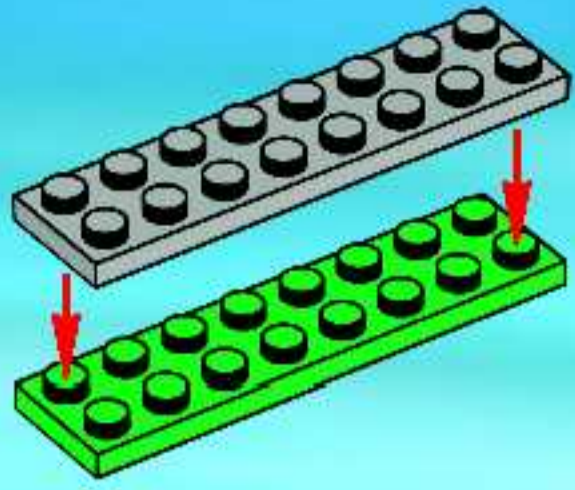

2

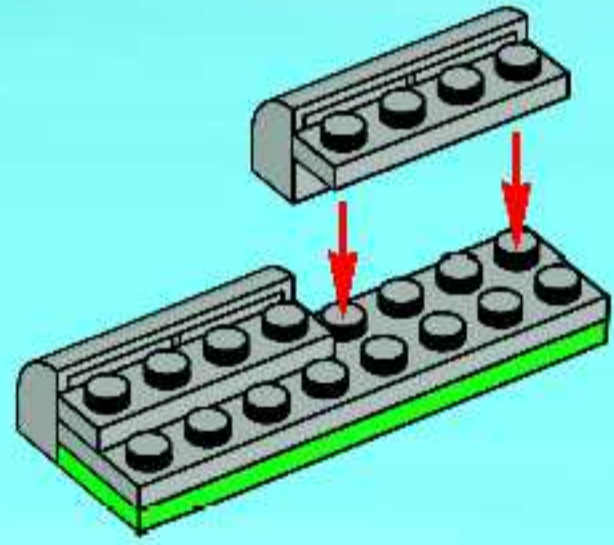

3

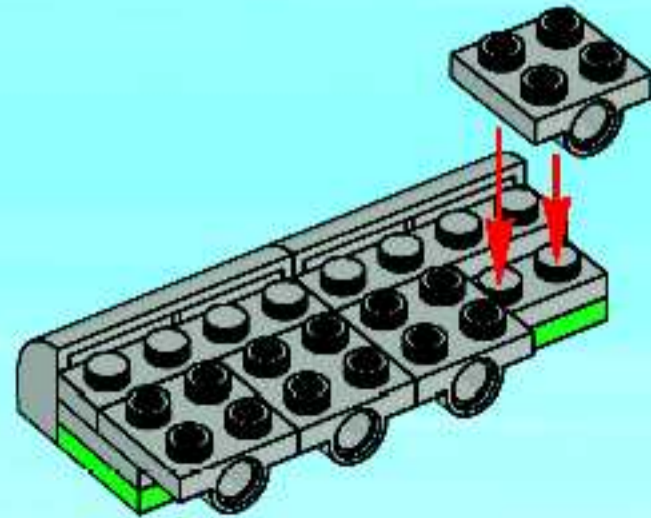

4

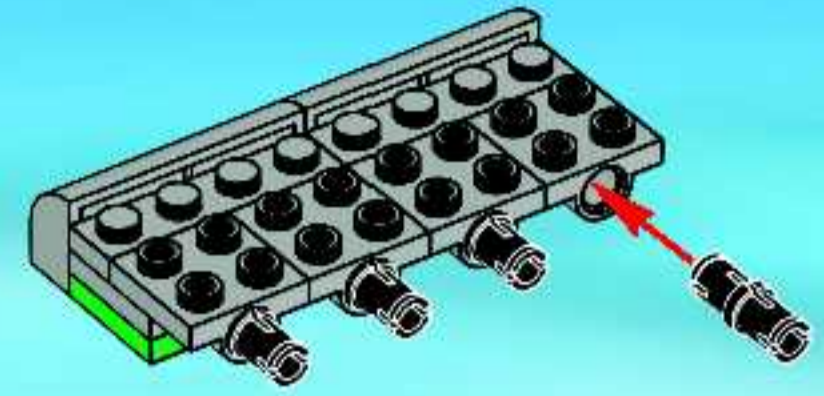

5

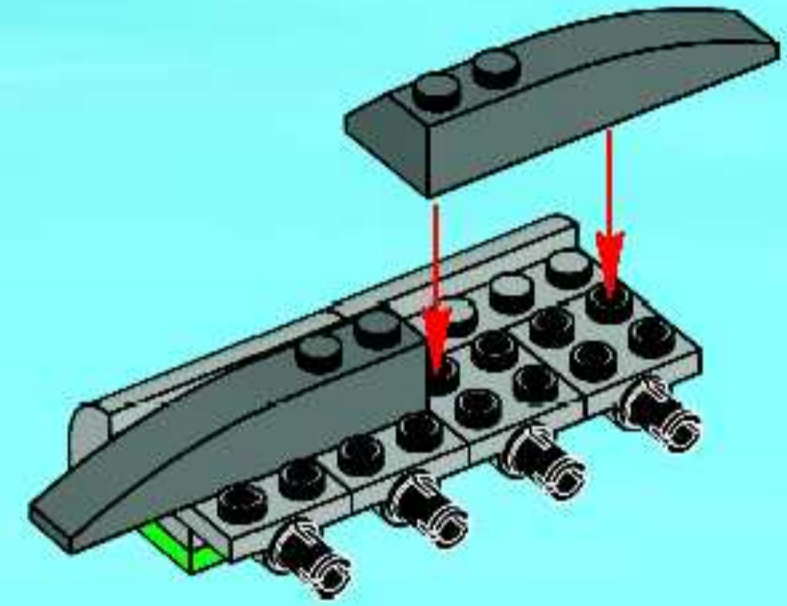

6

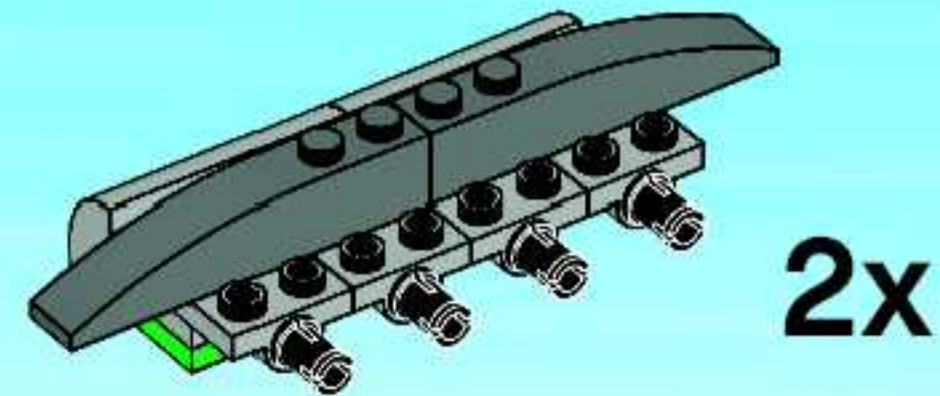



7

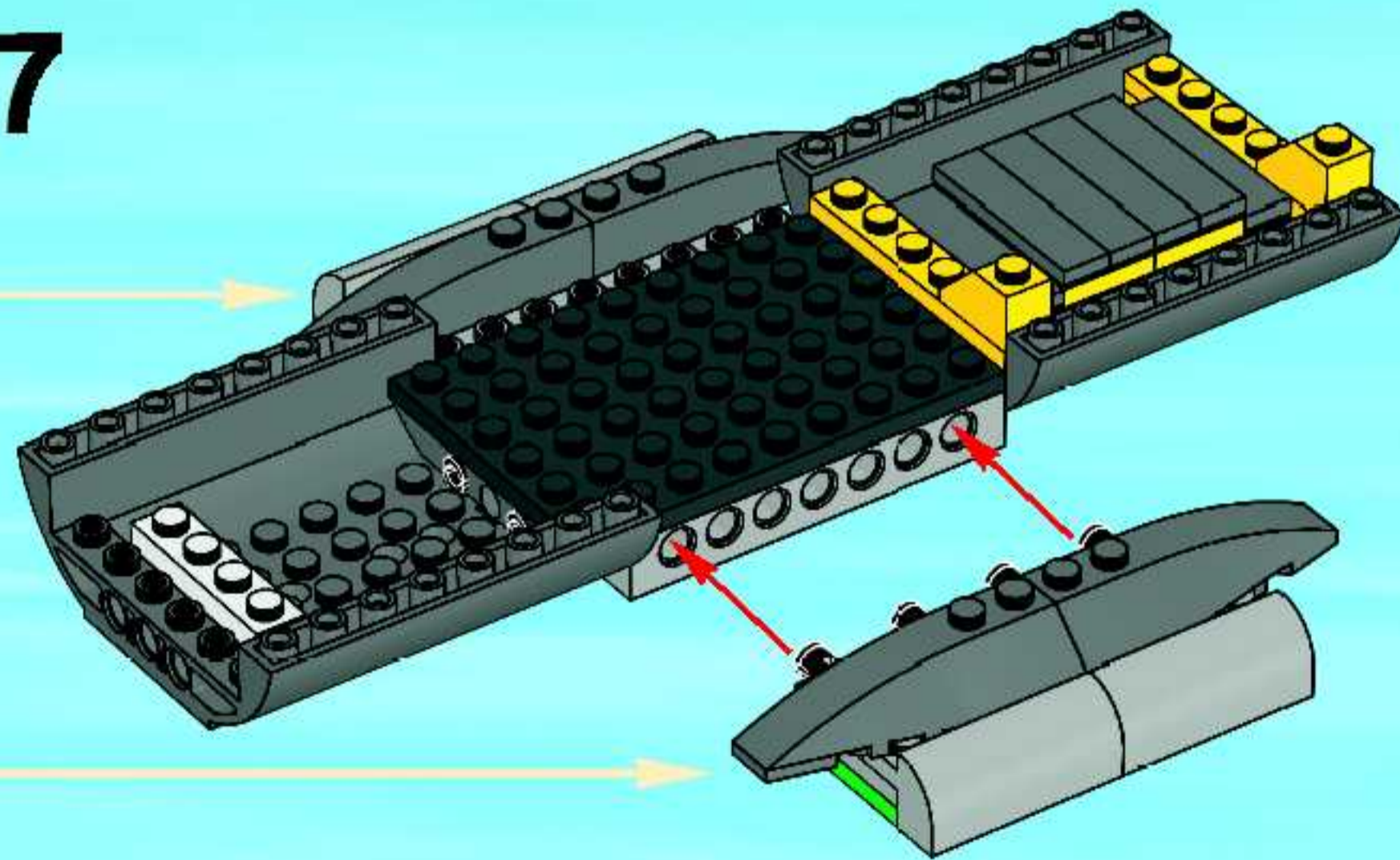

8

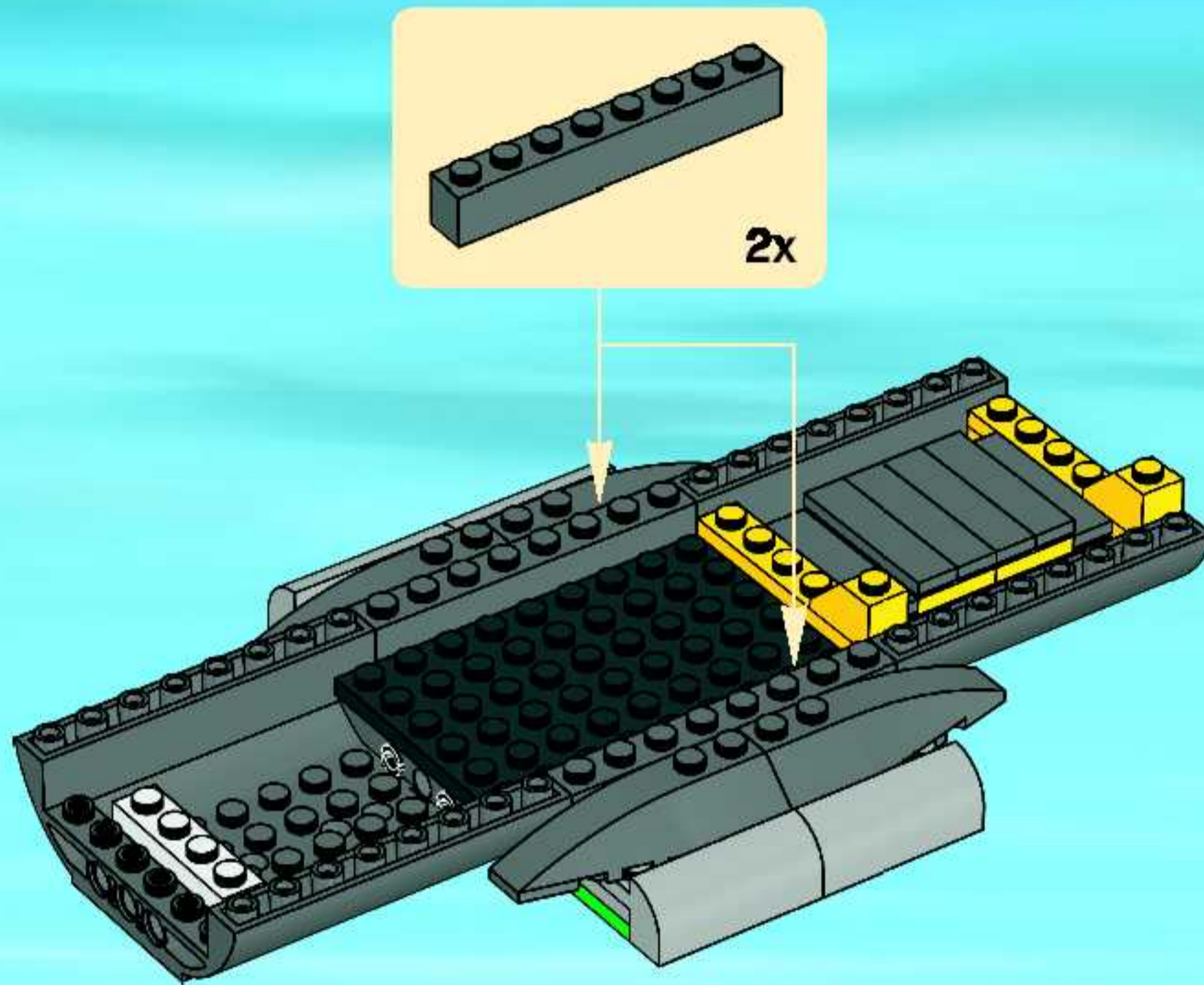

9

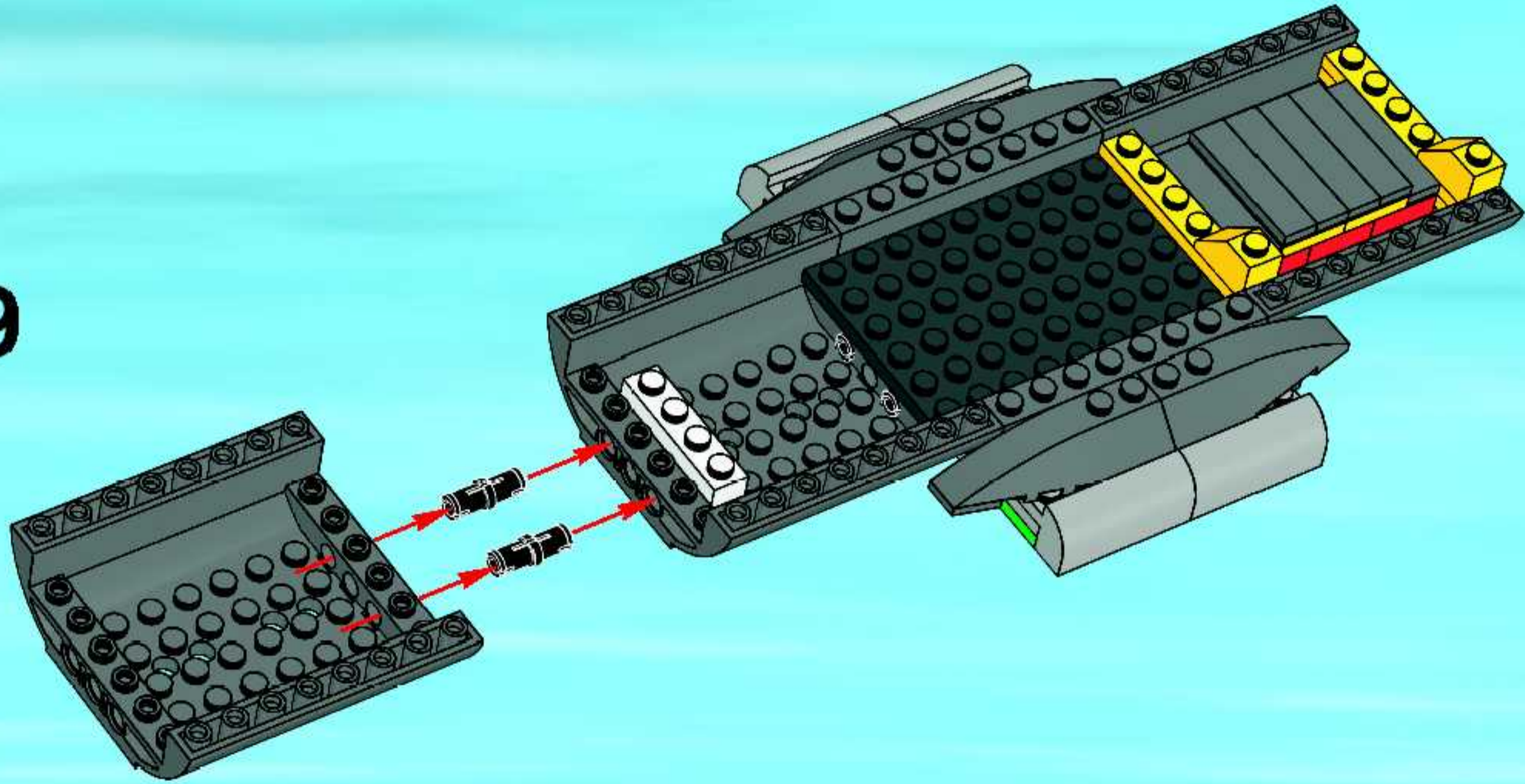

10

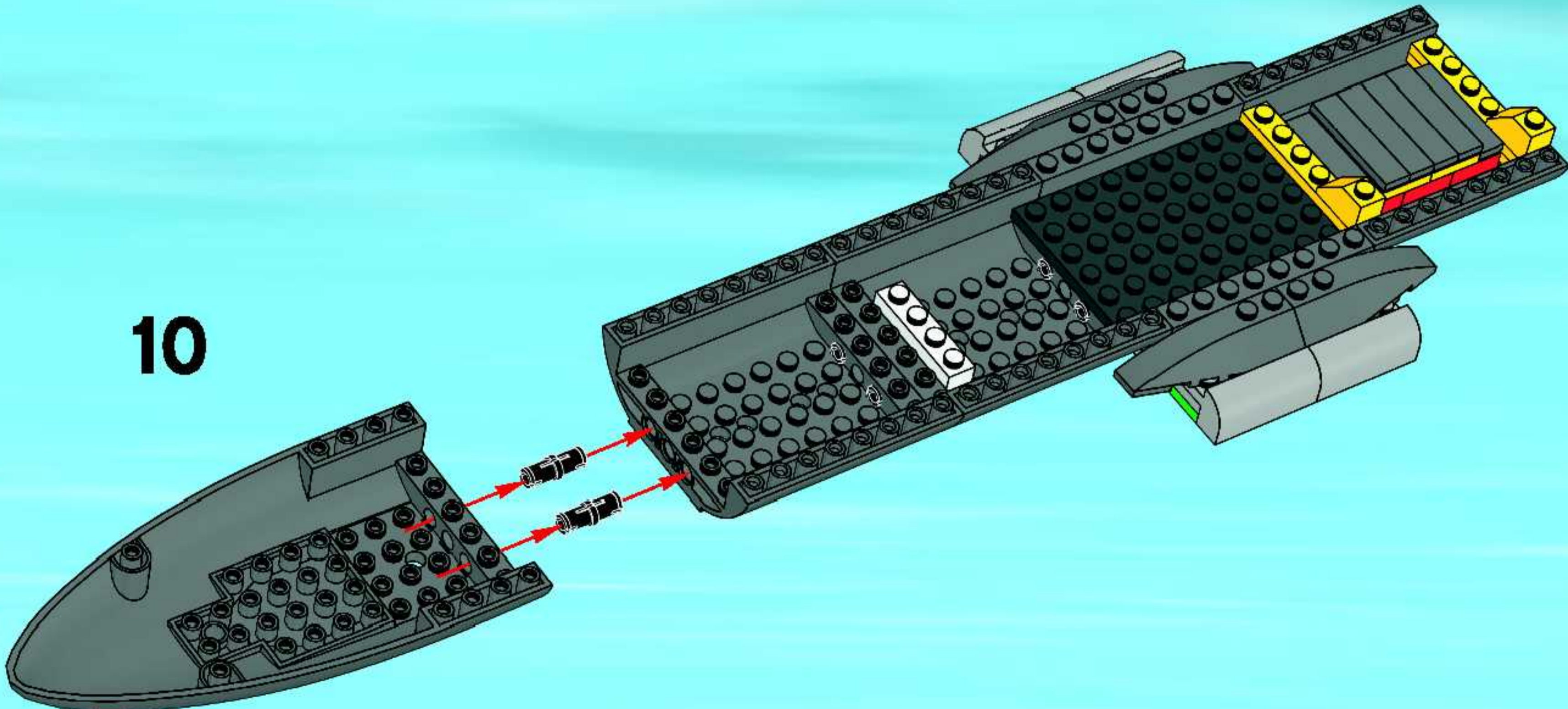

11

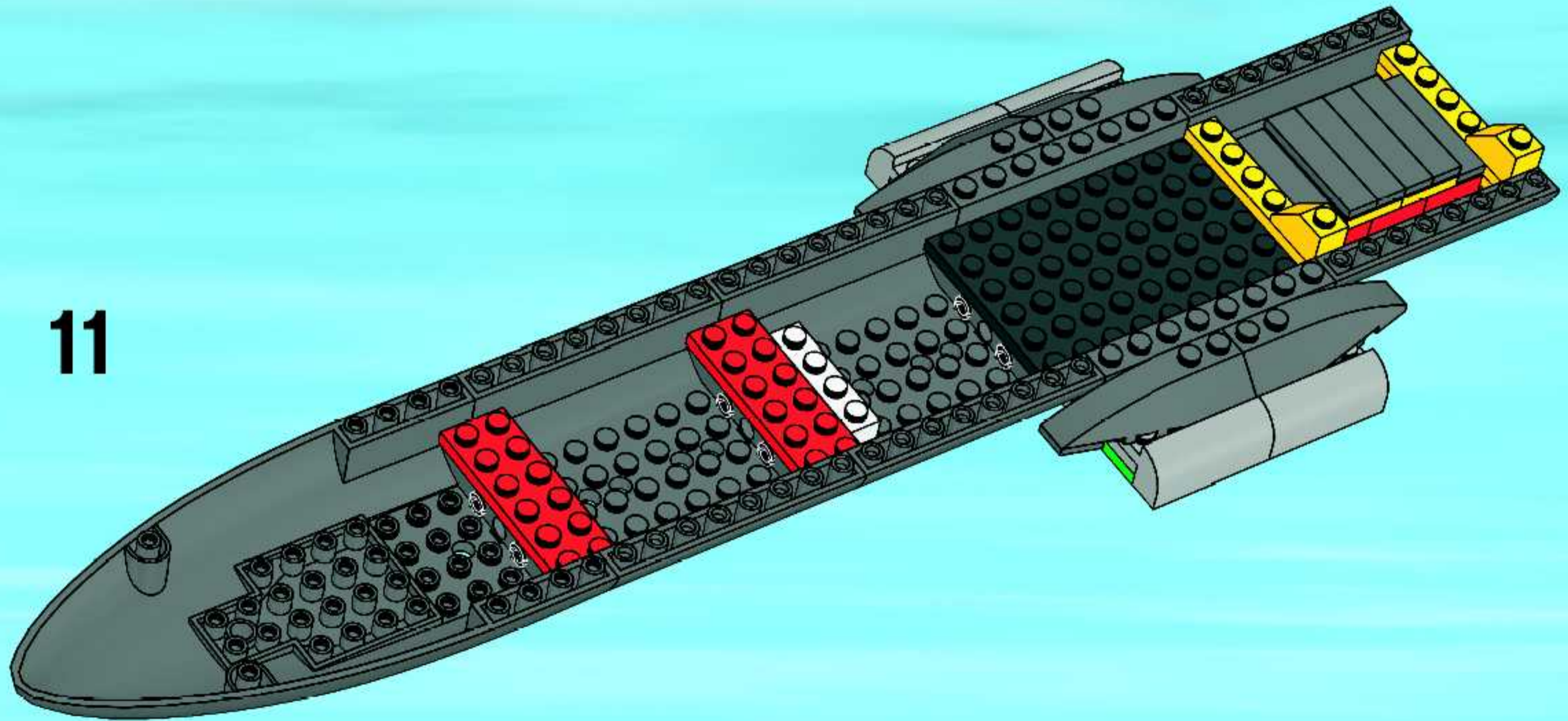

12

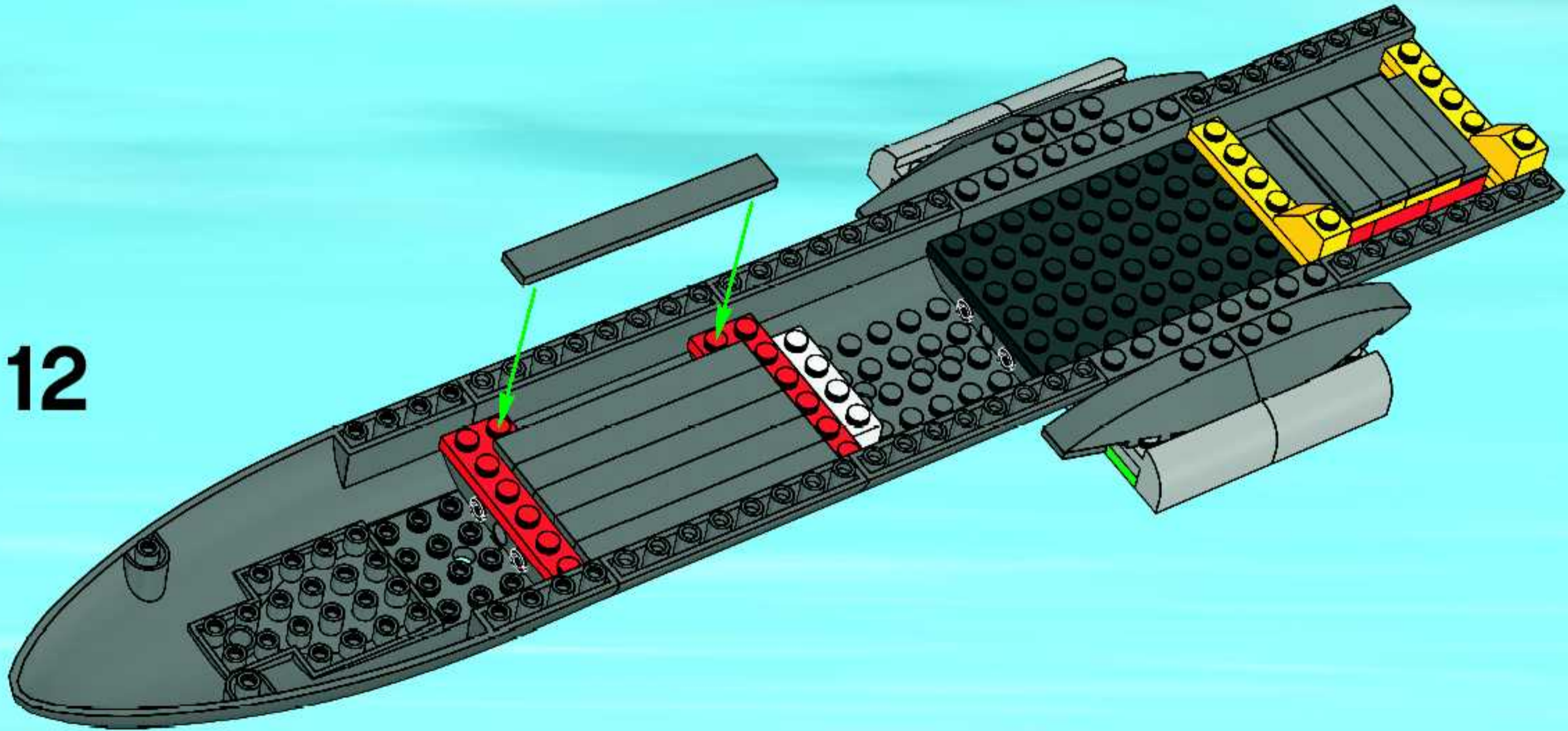

13

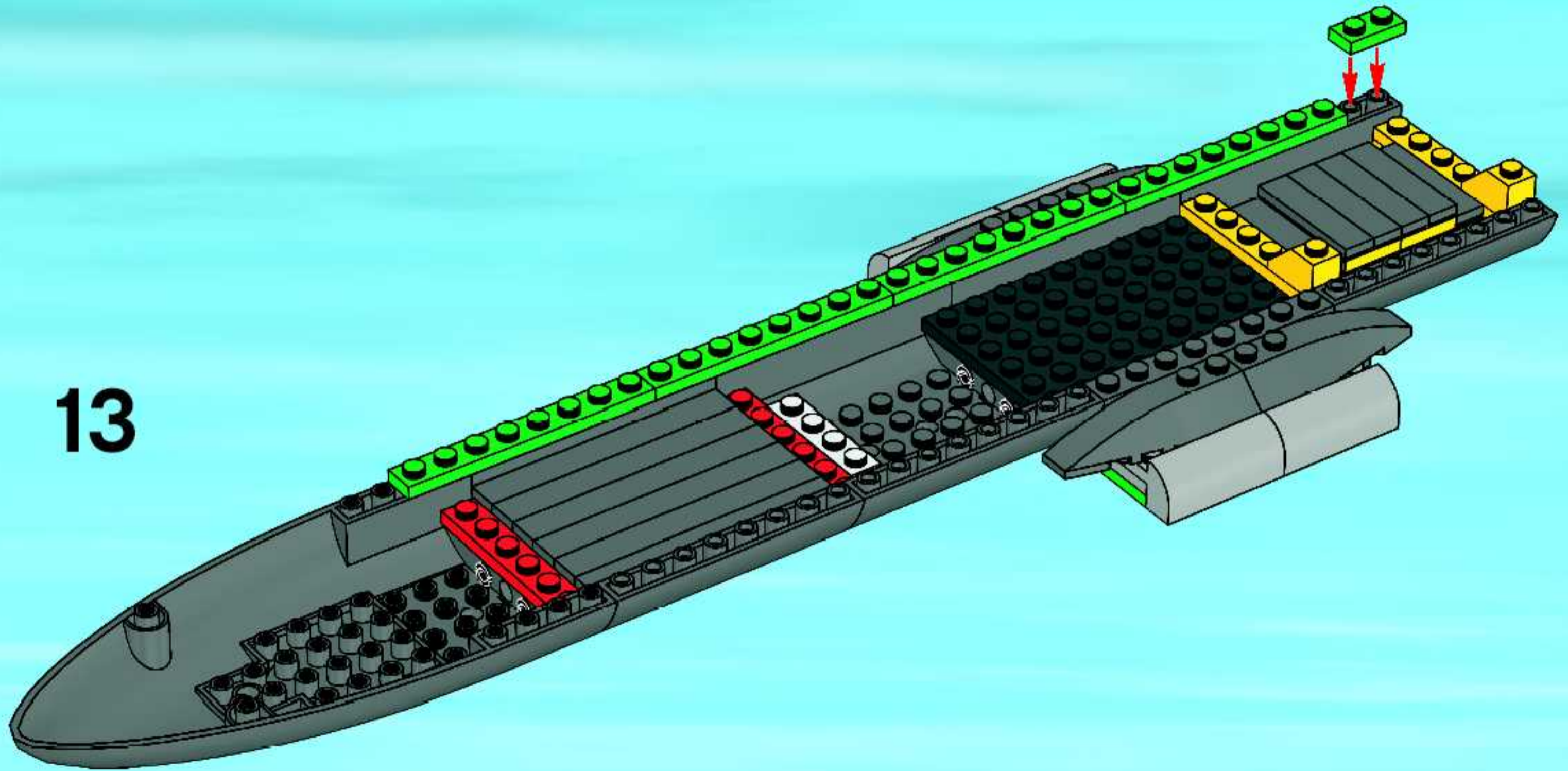

14

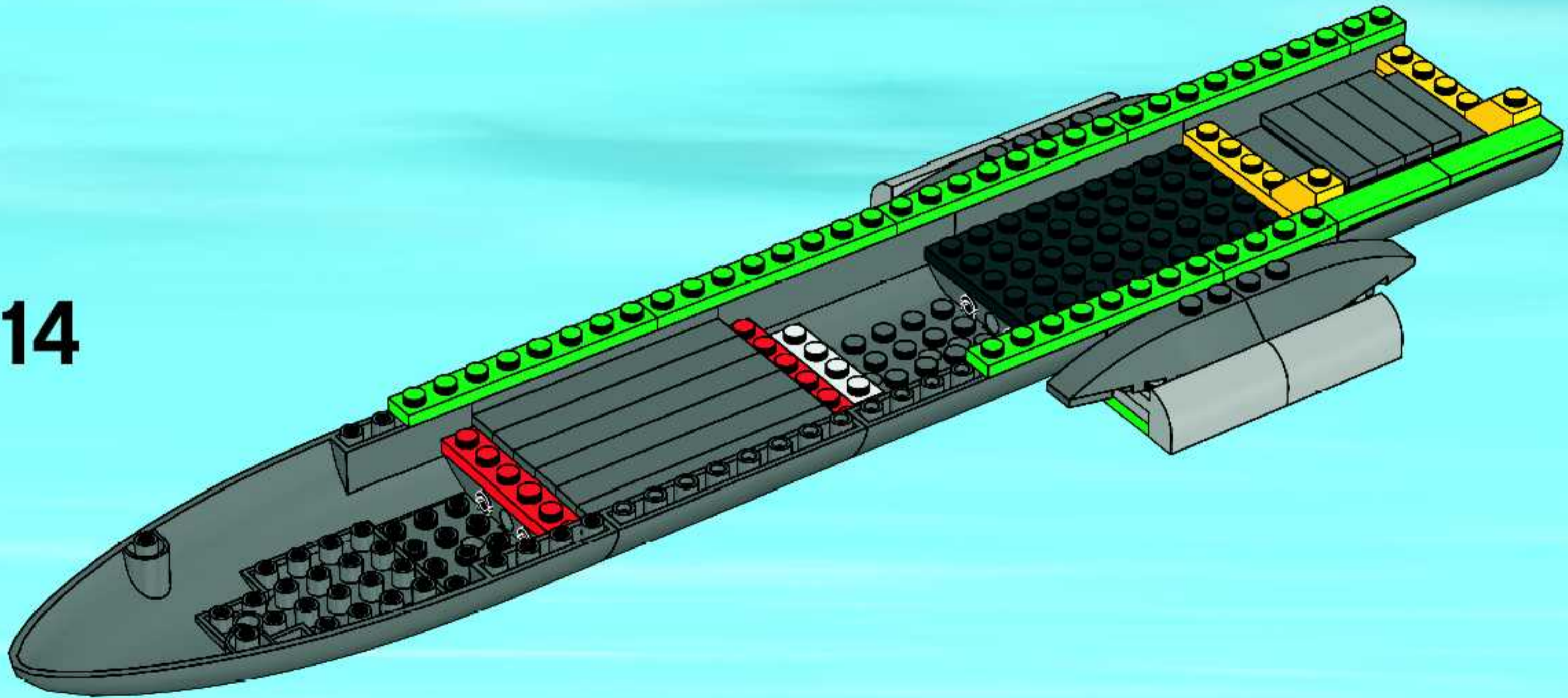



15

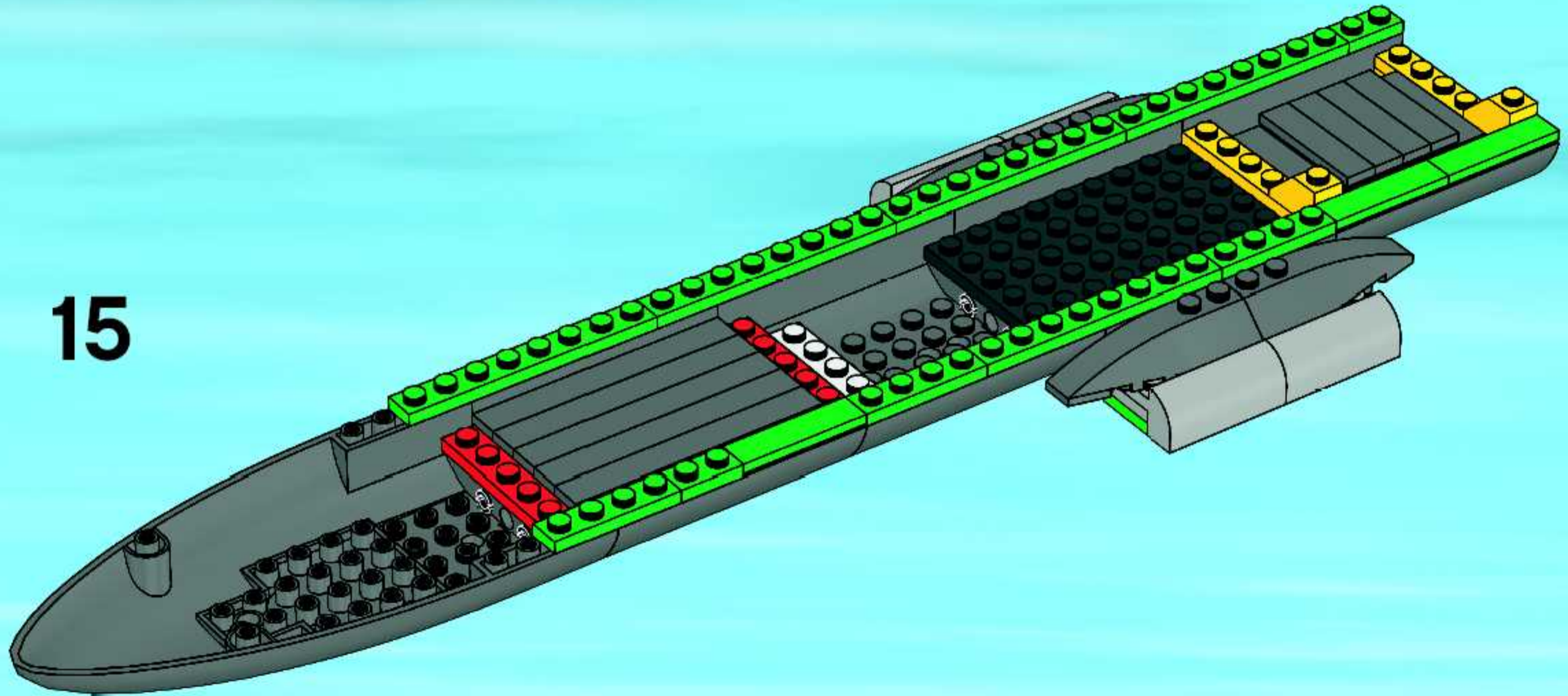

16

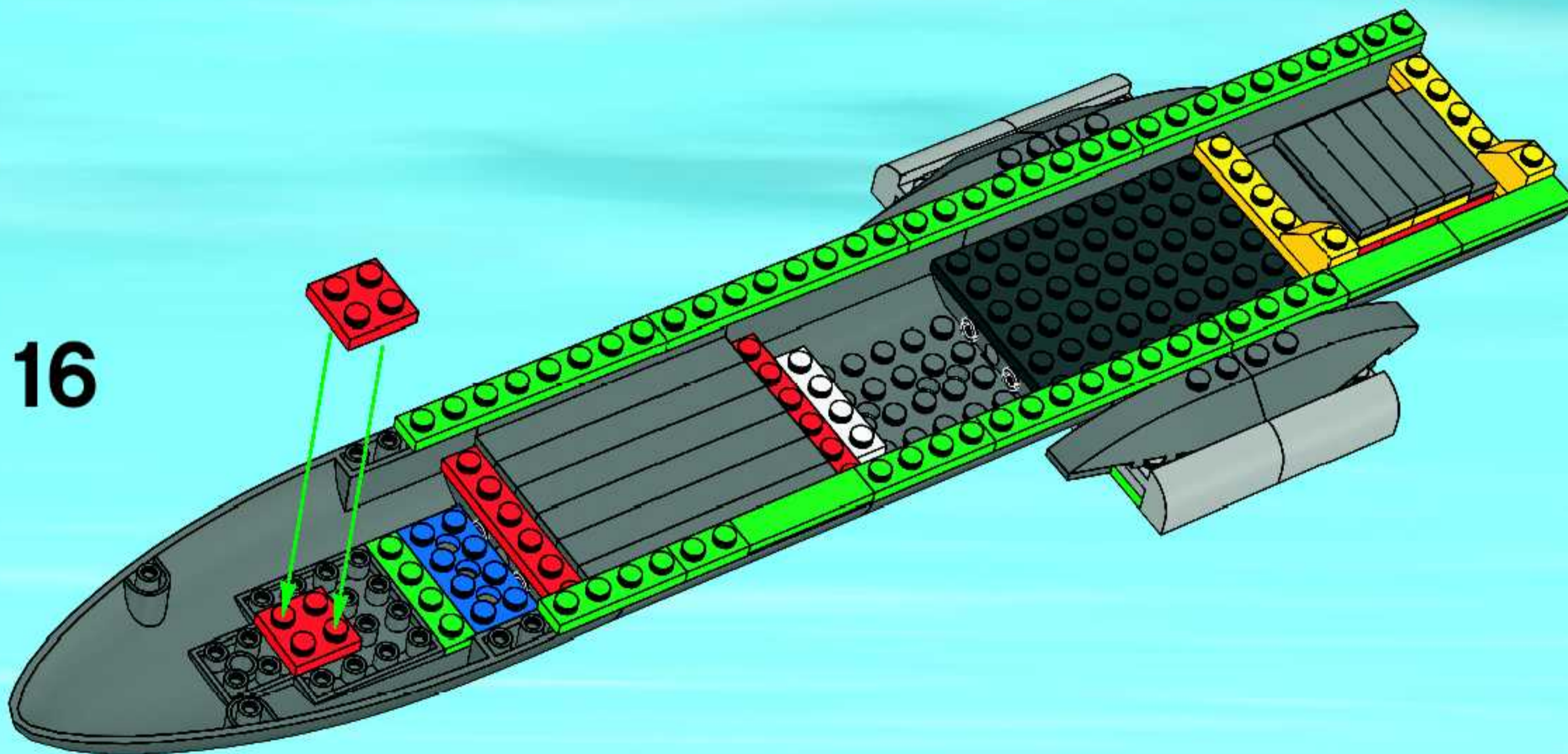



1

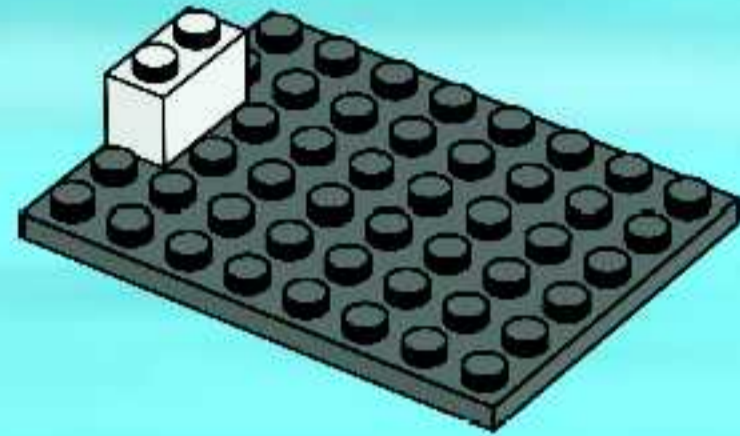

2

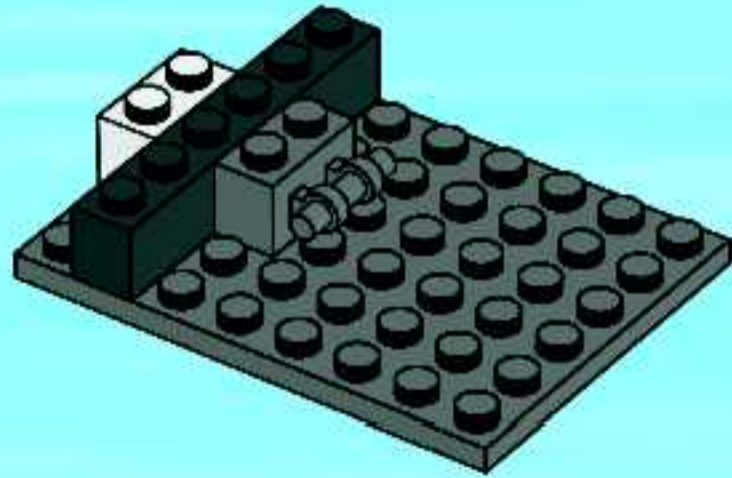

3



4

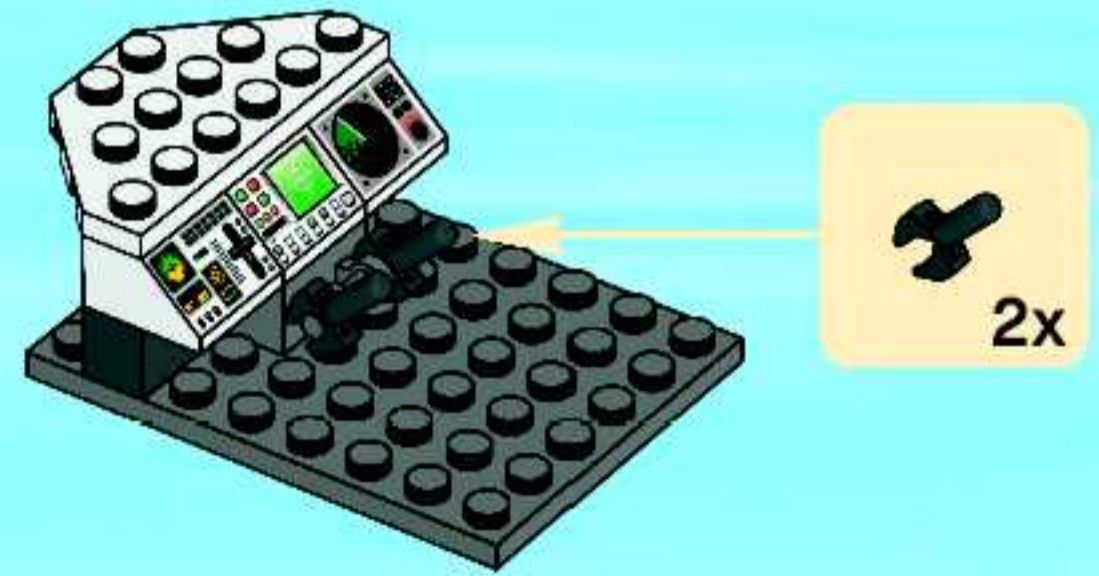

5

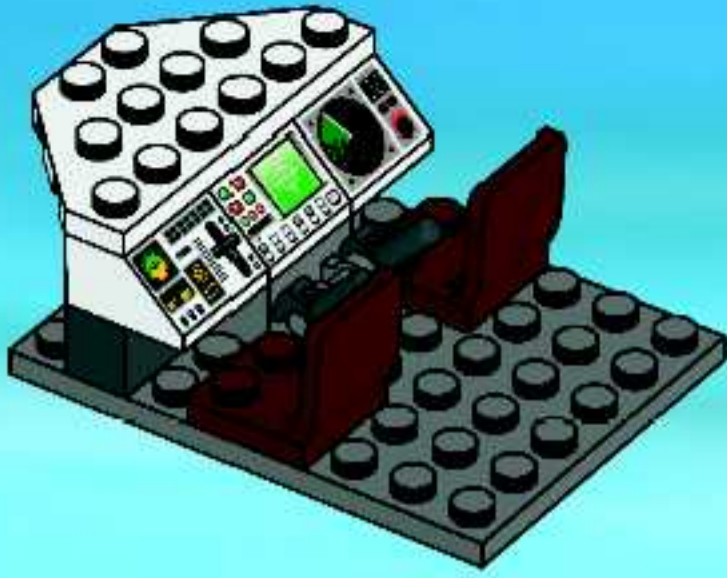

6

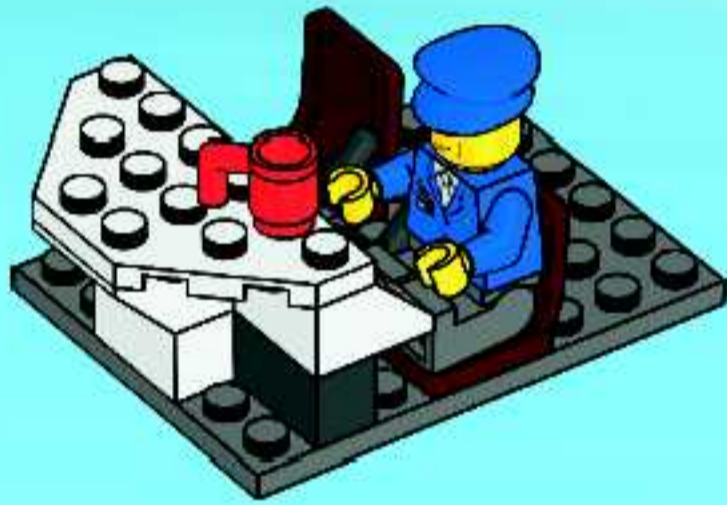

17

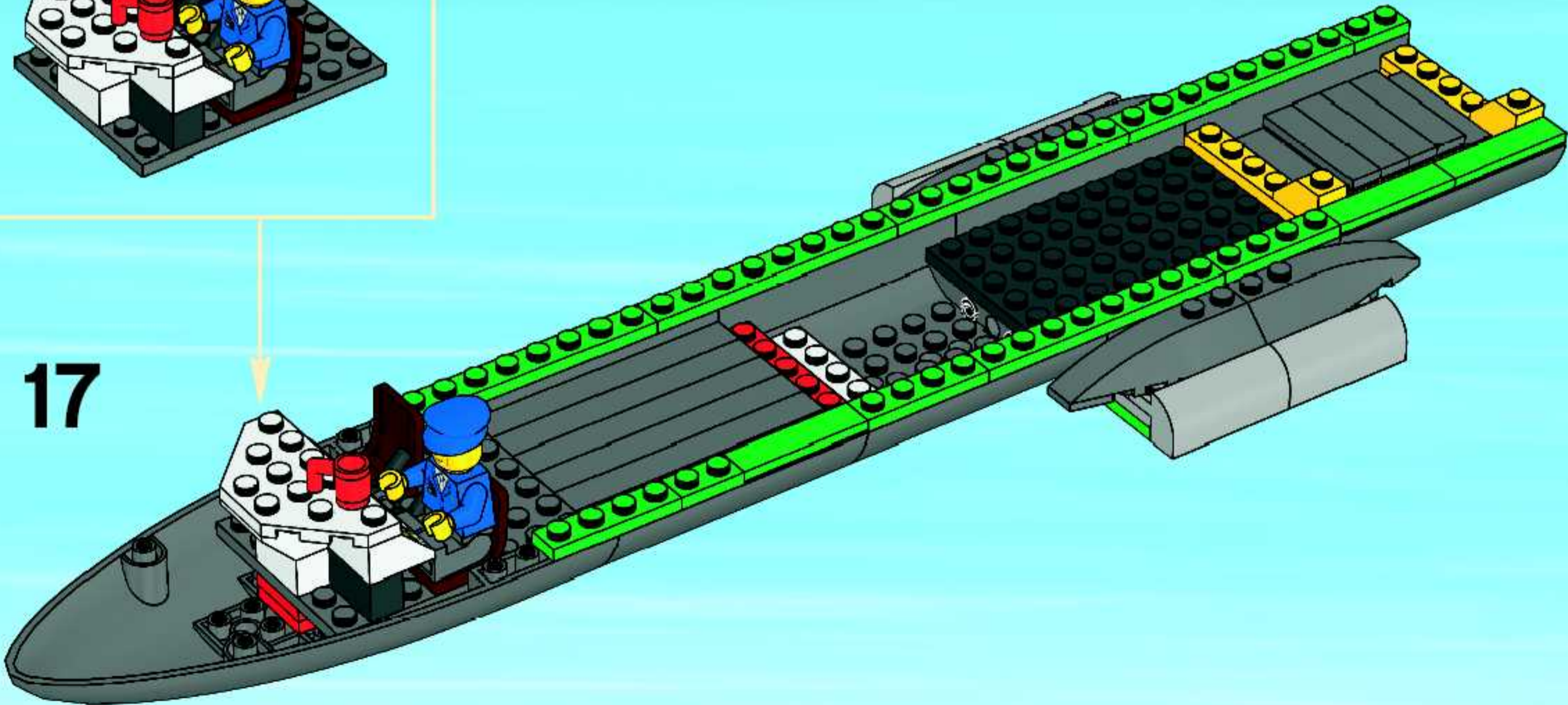

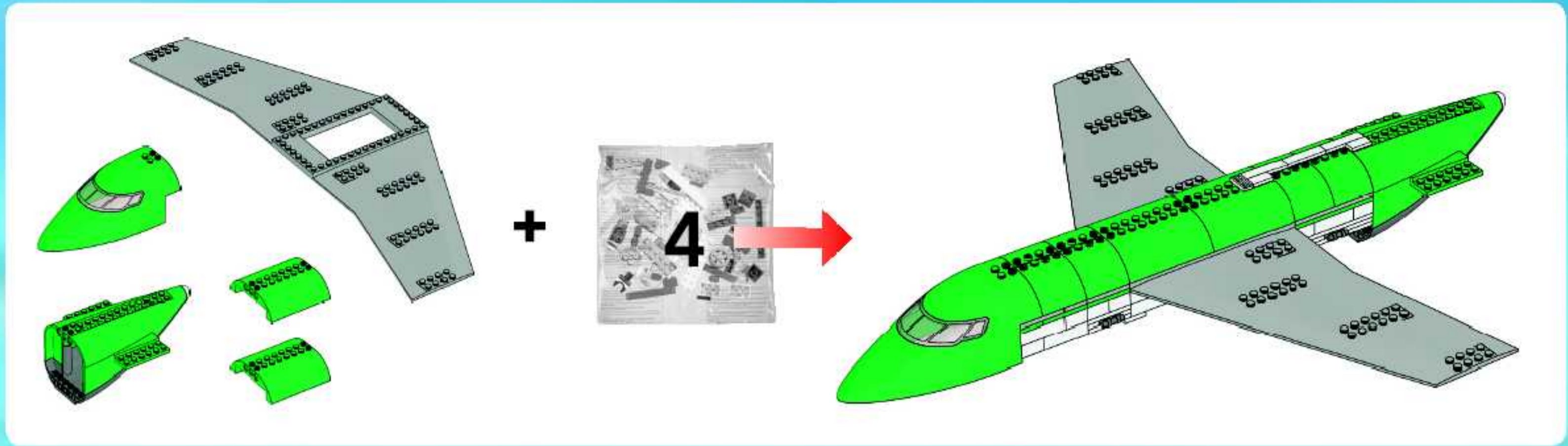

18

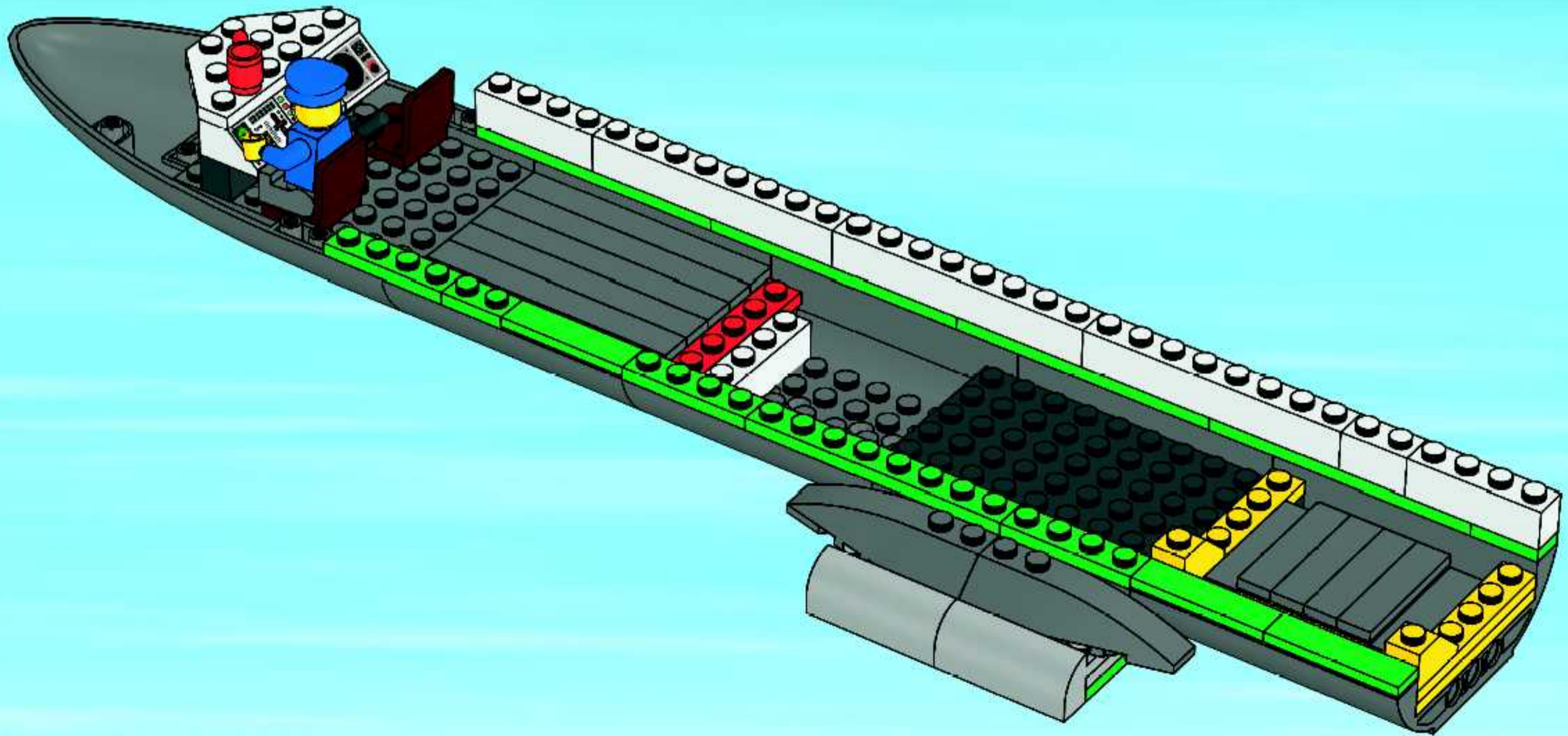

19

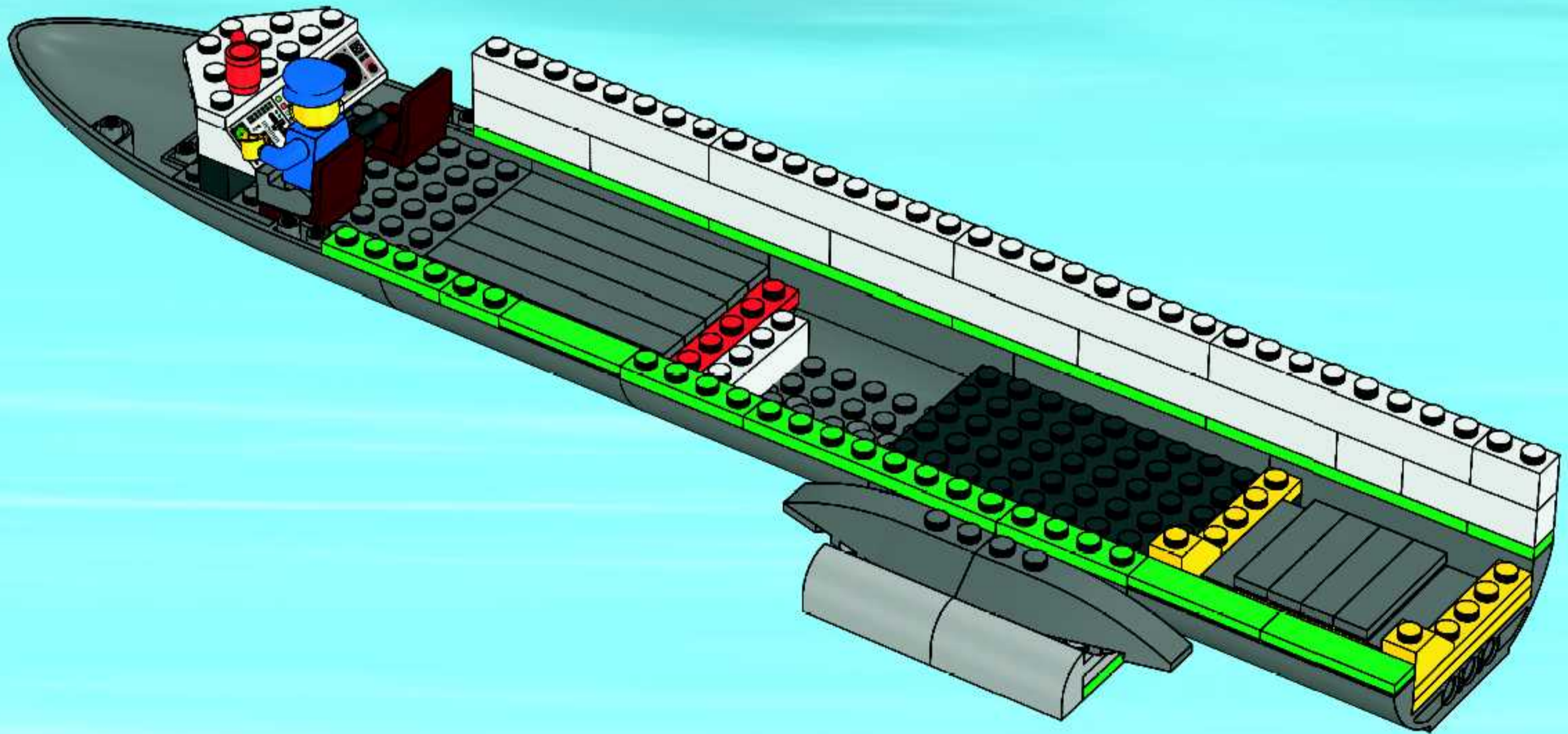

20

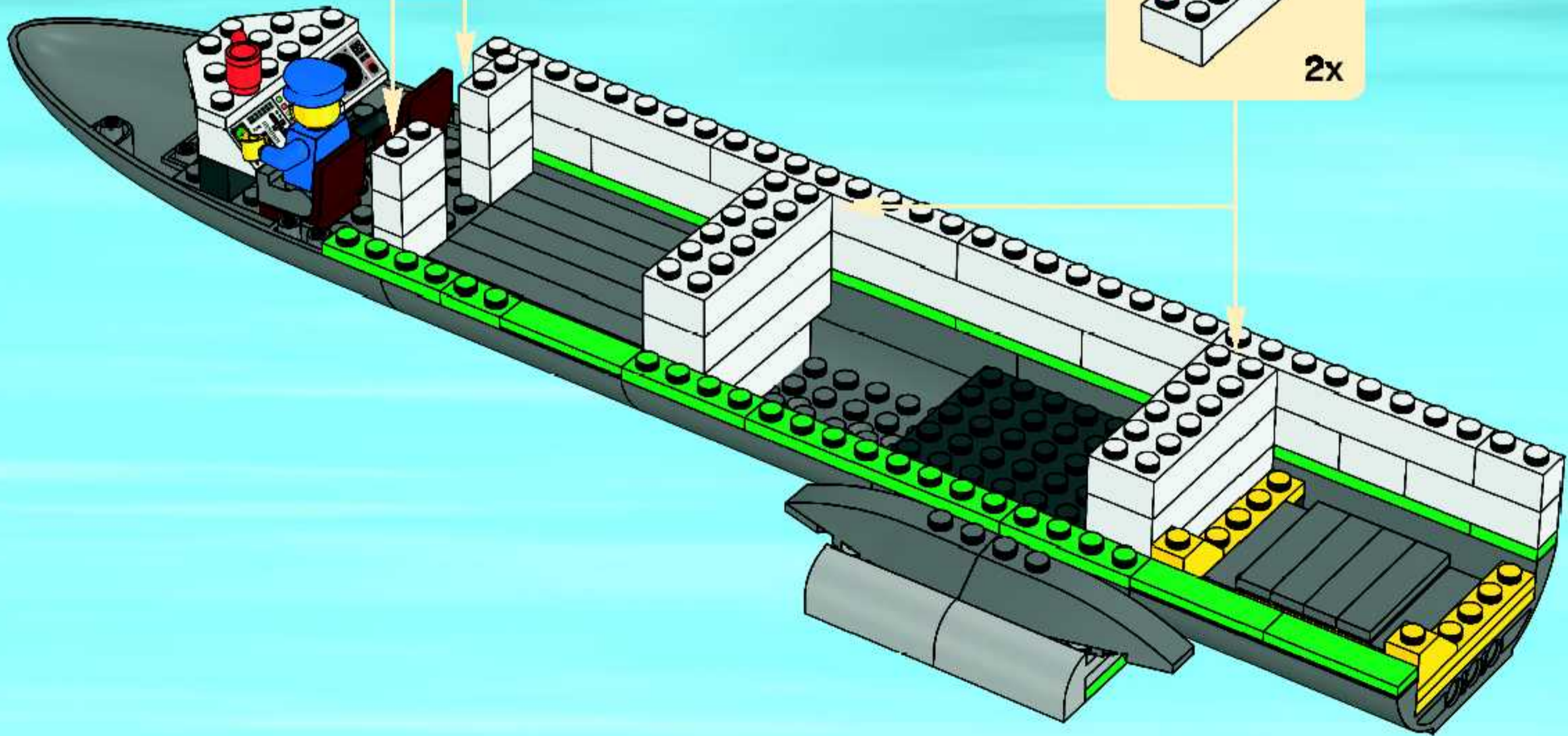
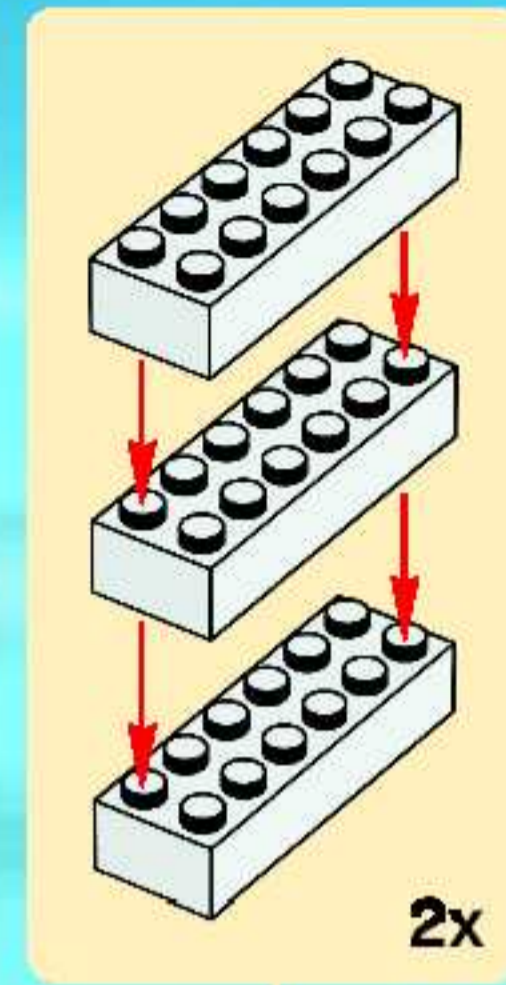
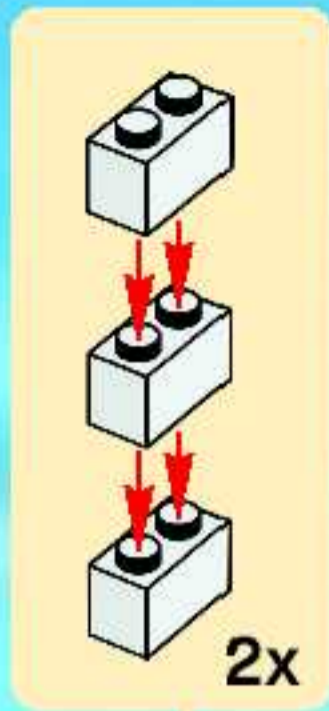

21

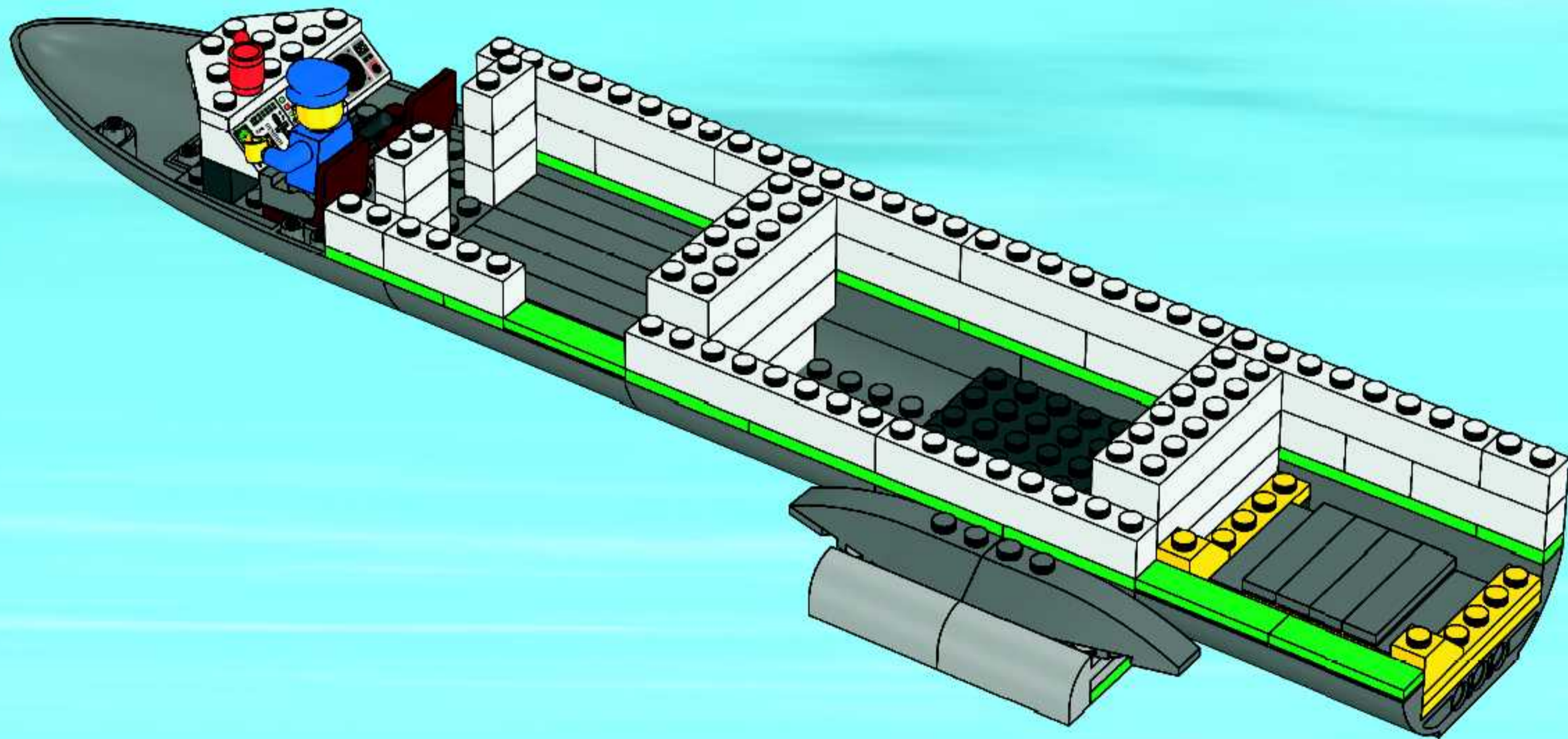



22

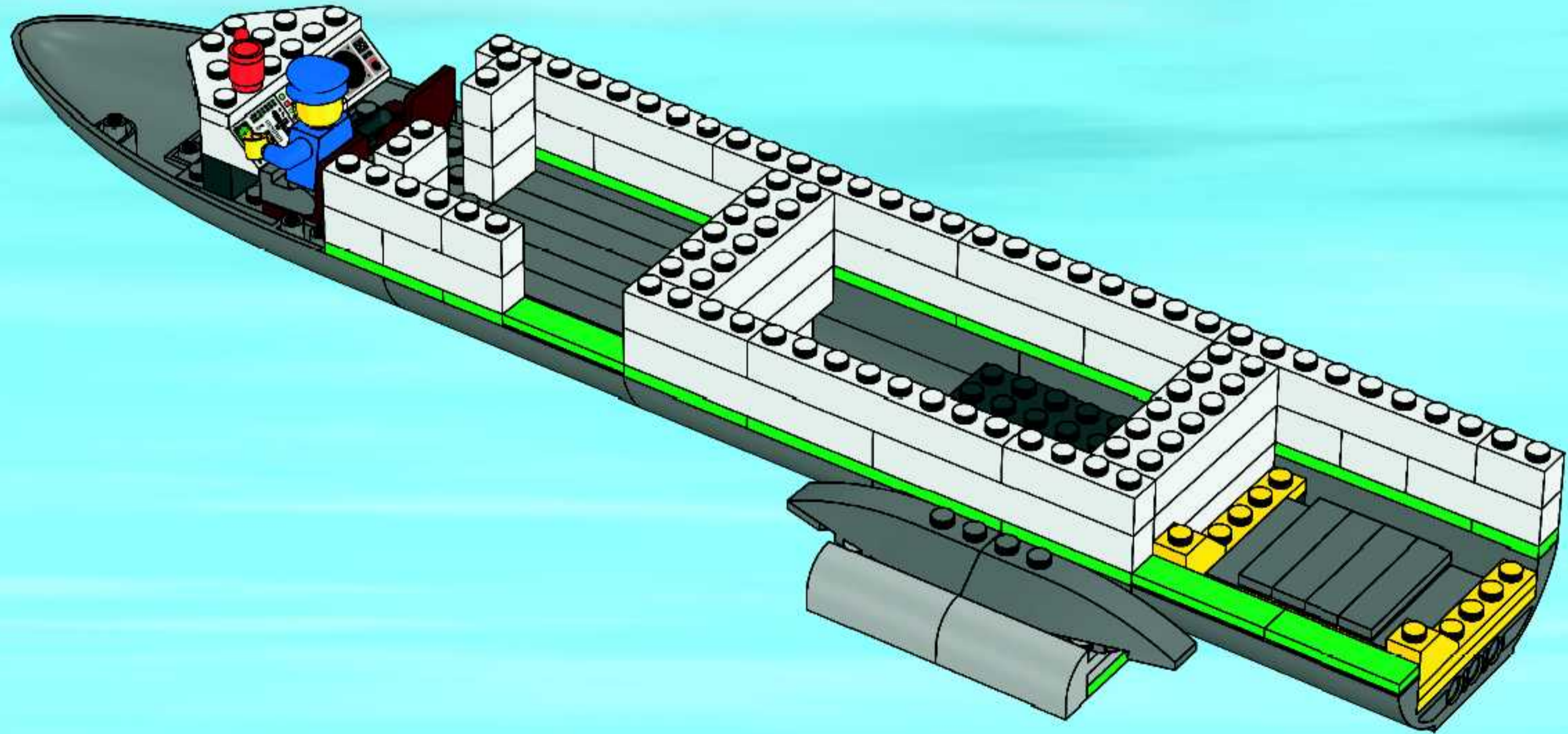

23

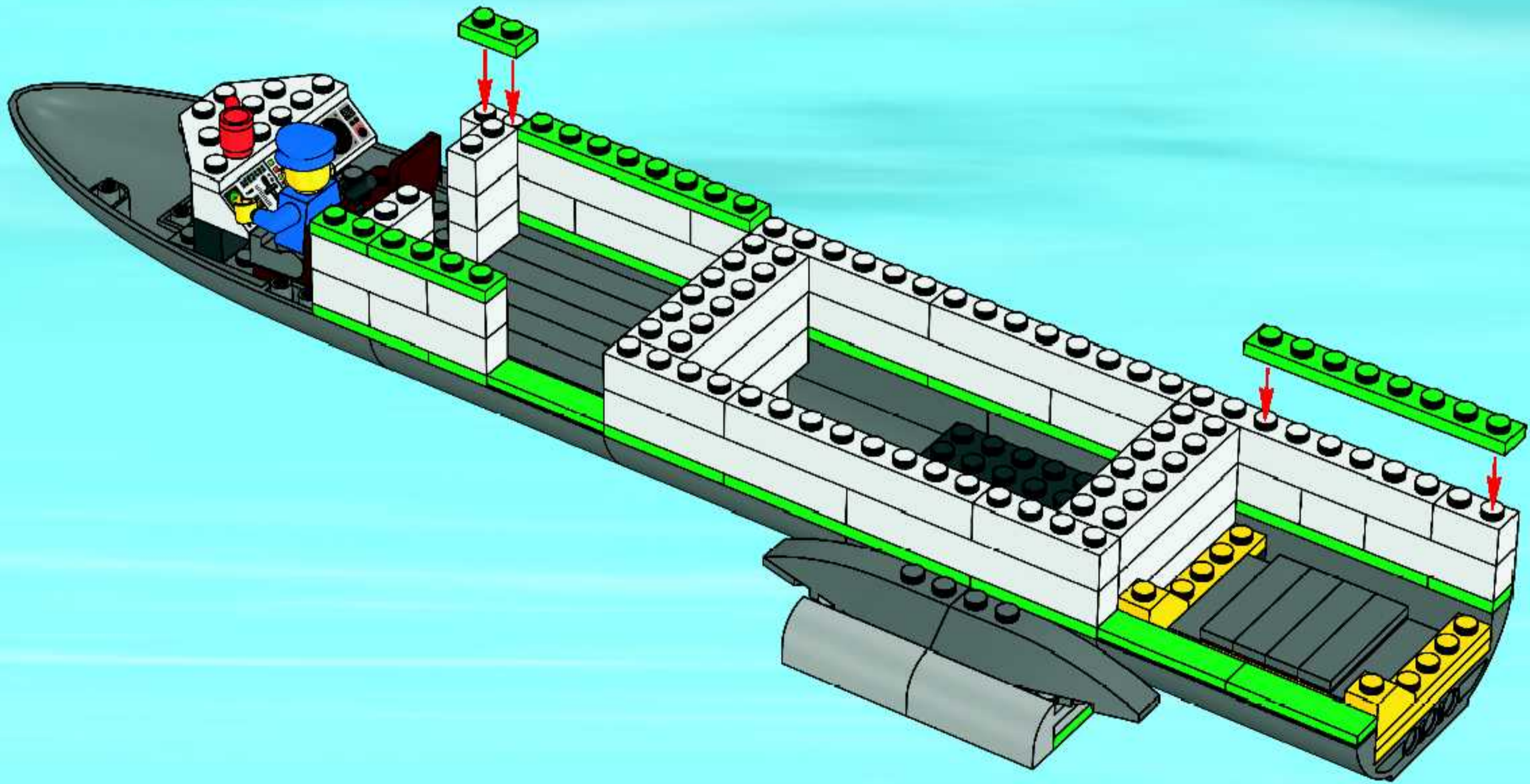

24

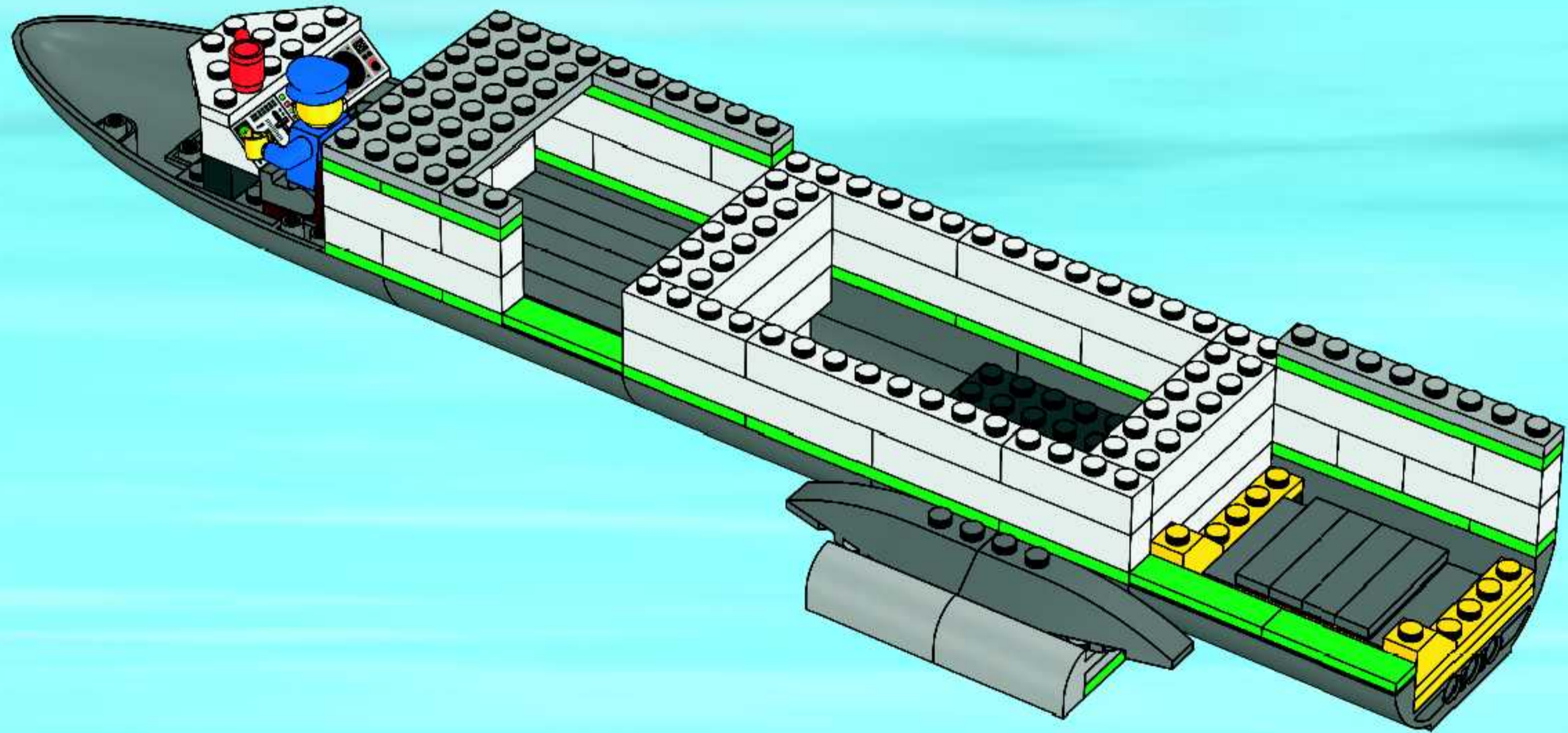

25

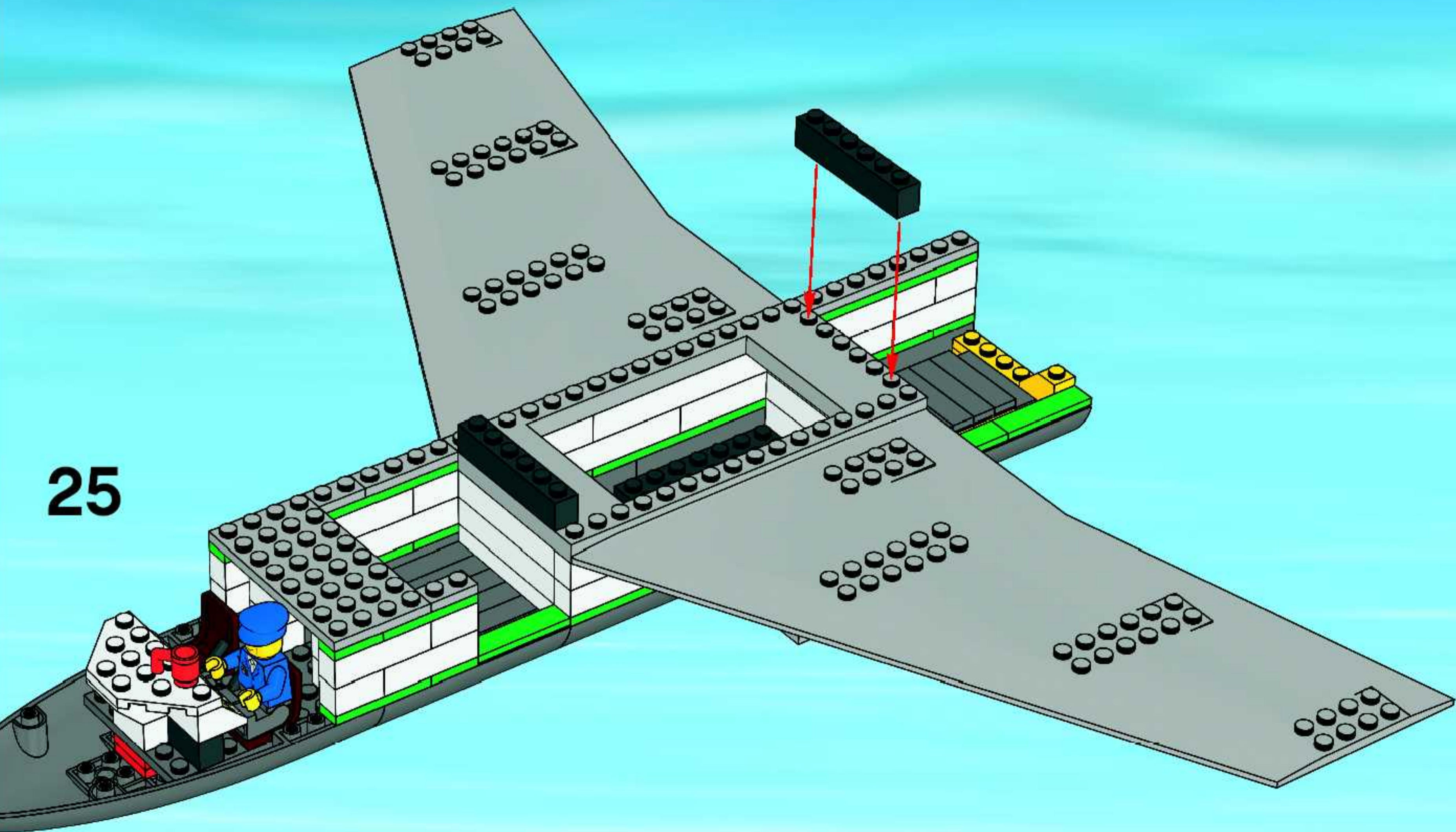

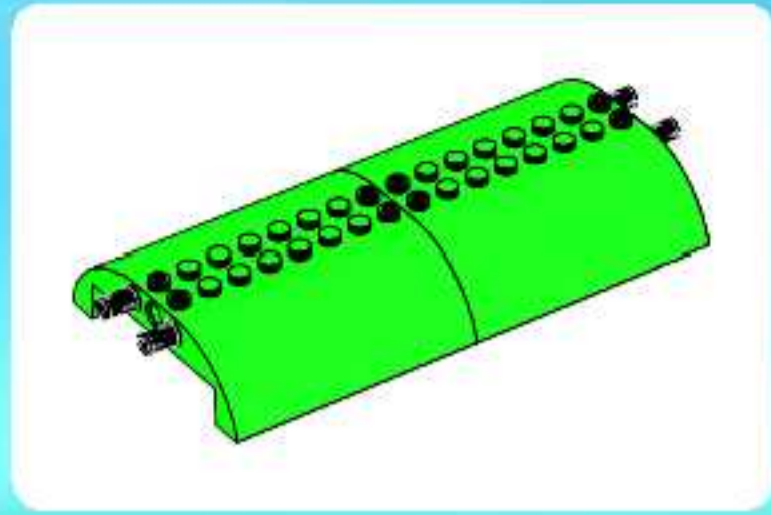

1

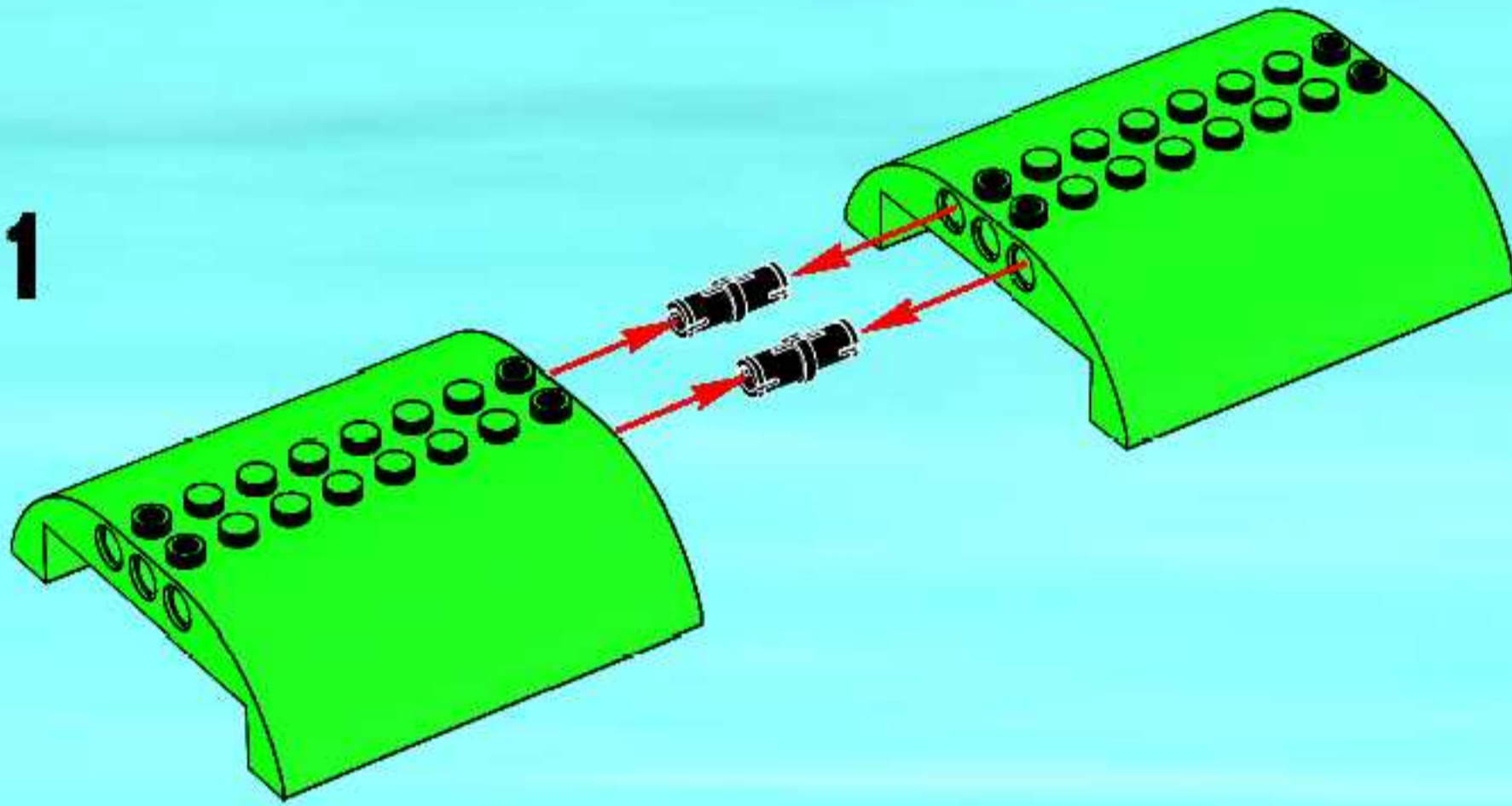

2

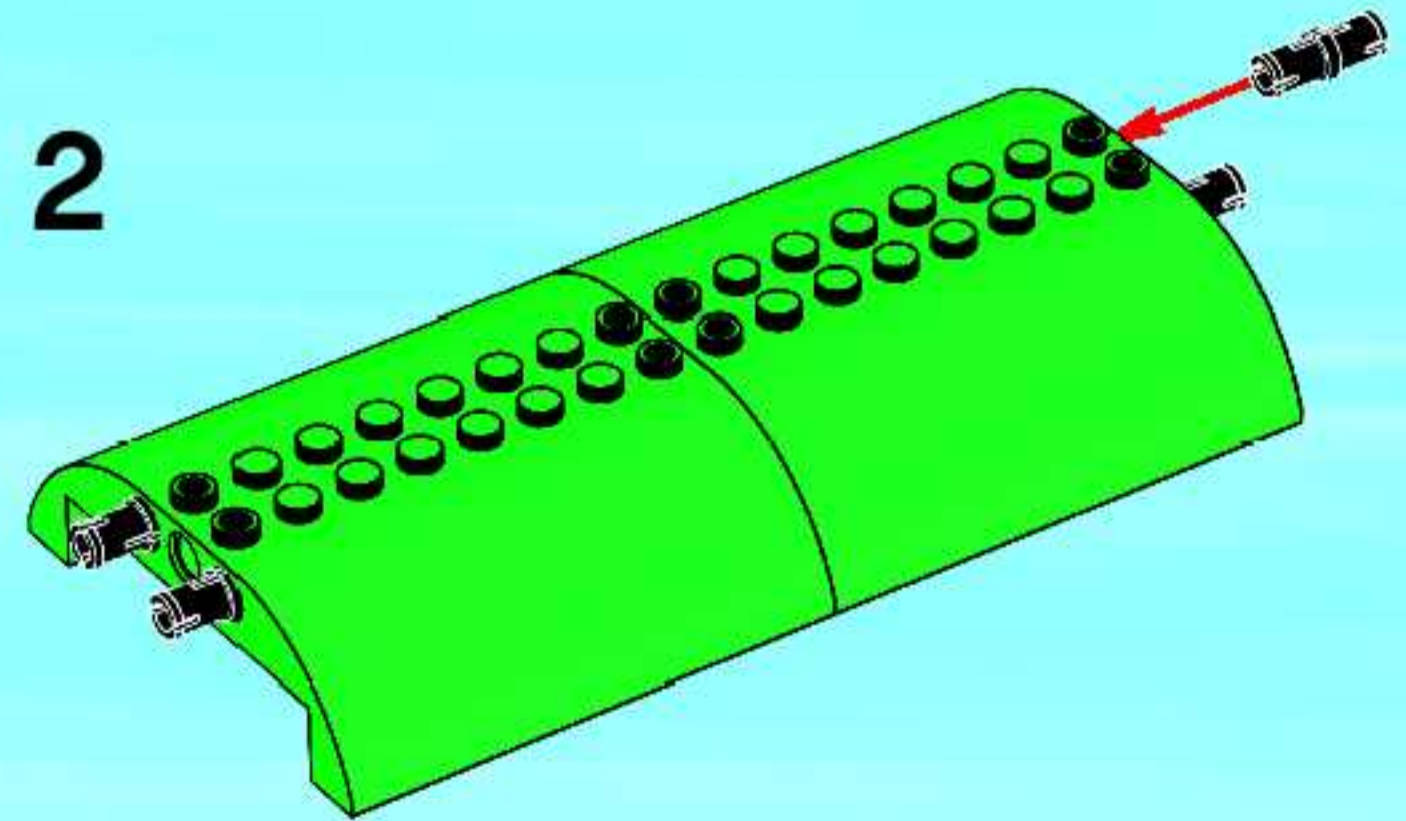

26

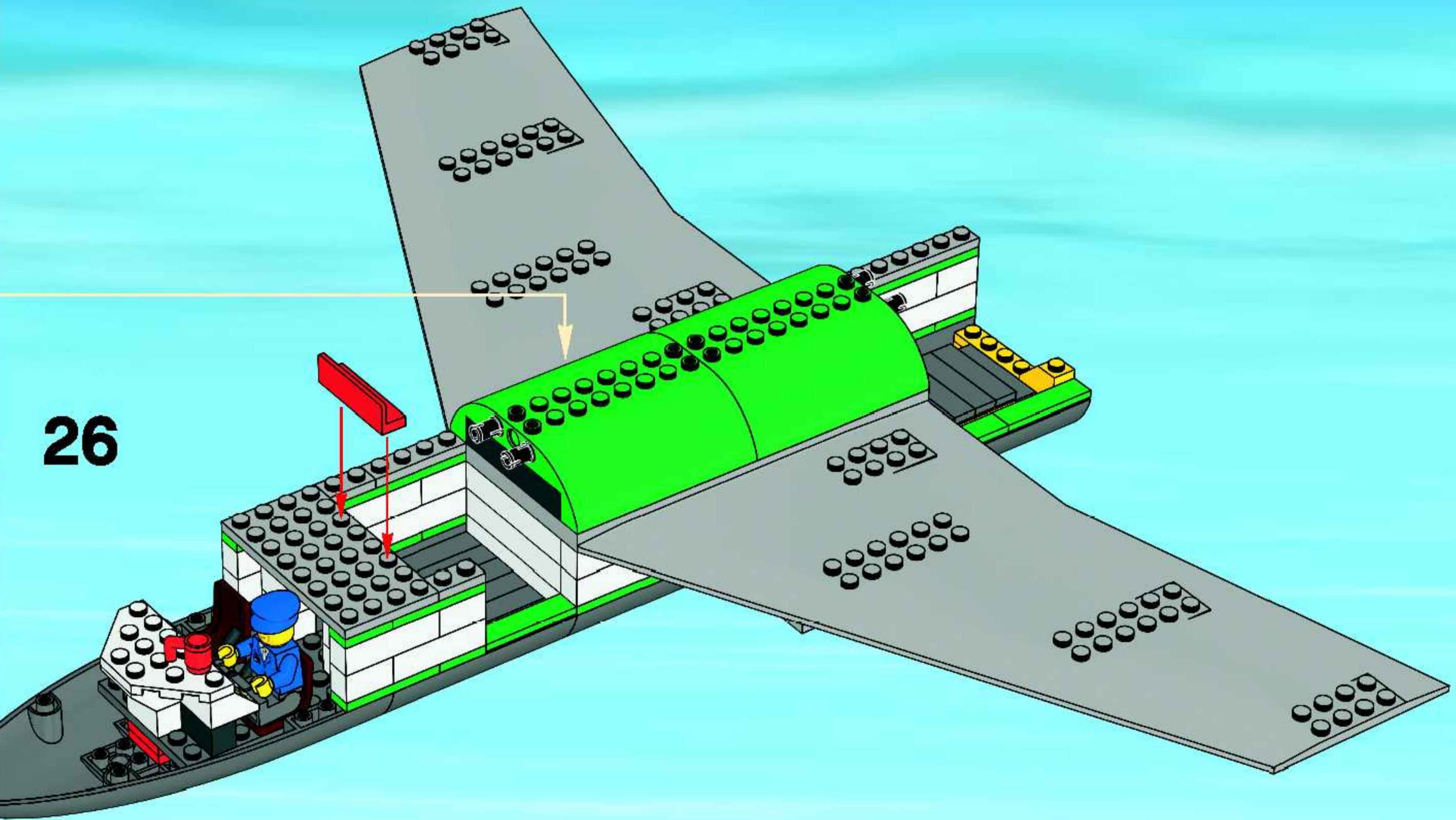

27

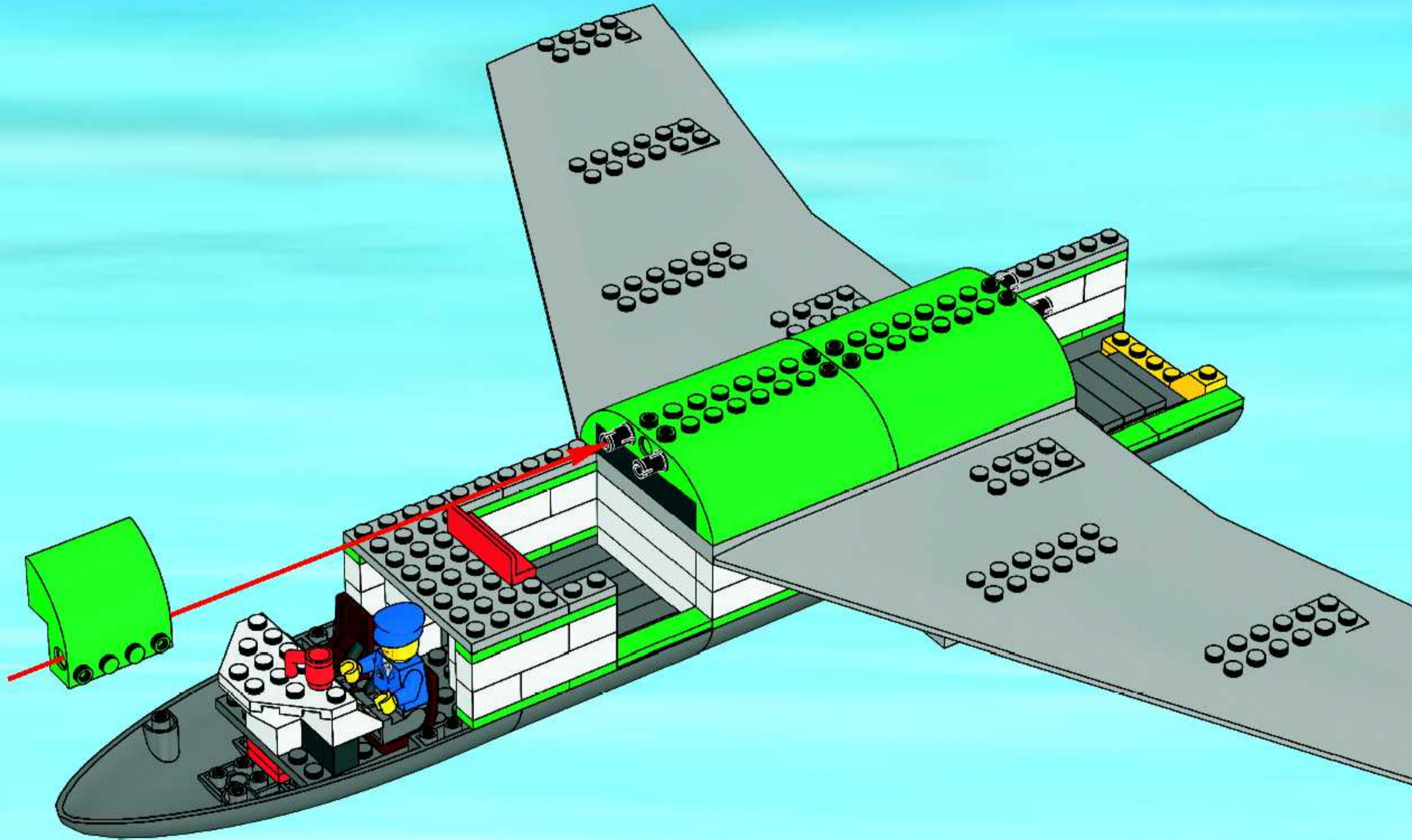

1

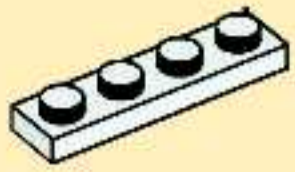

2

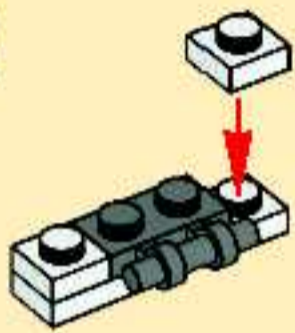

3

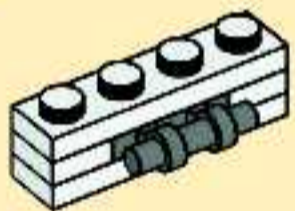

4

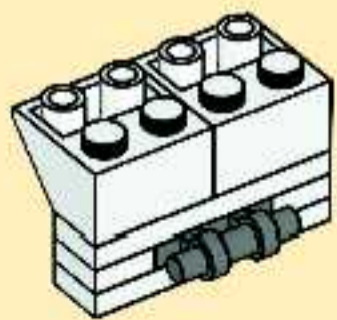

5

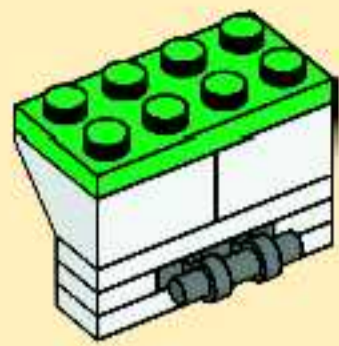

6

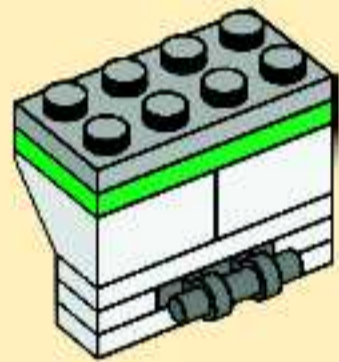

7

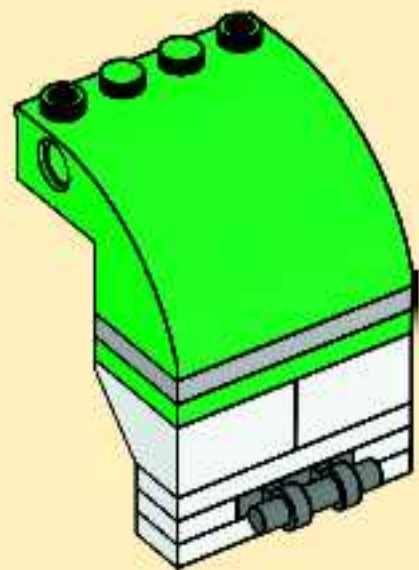

28

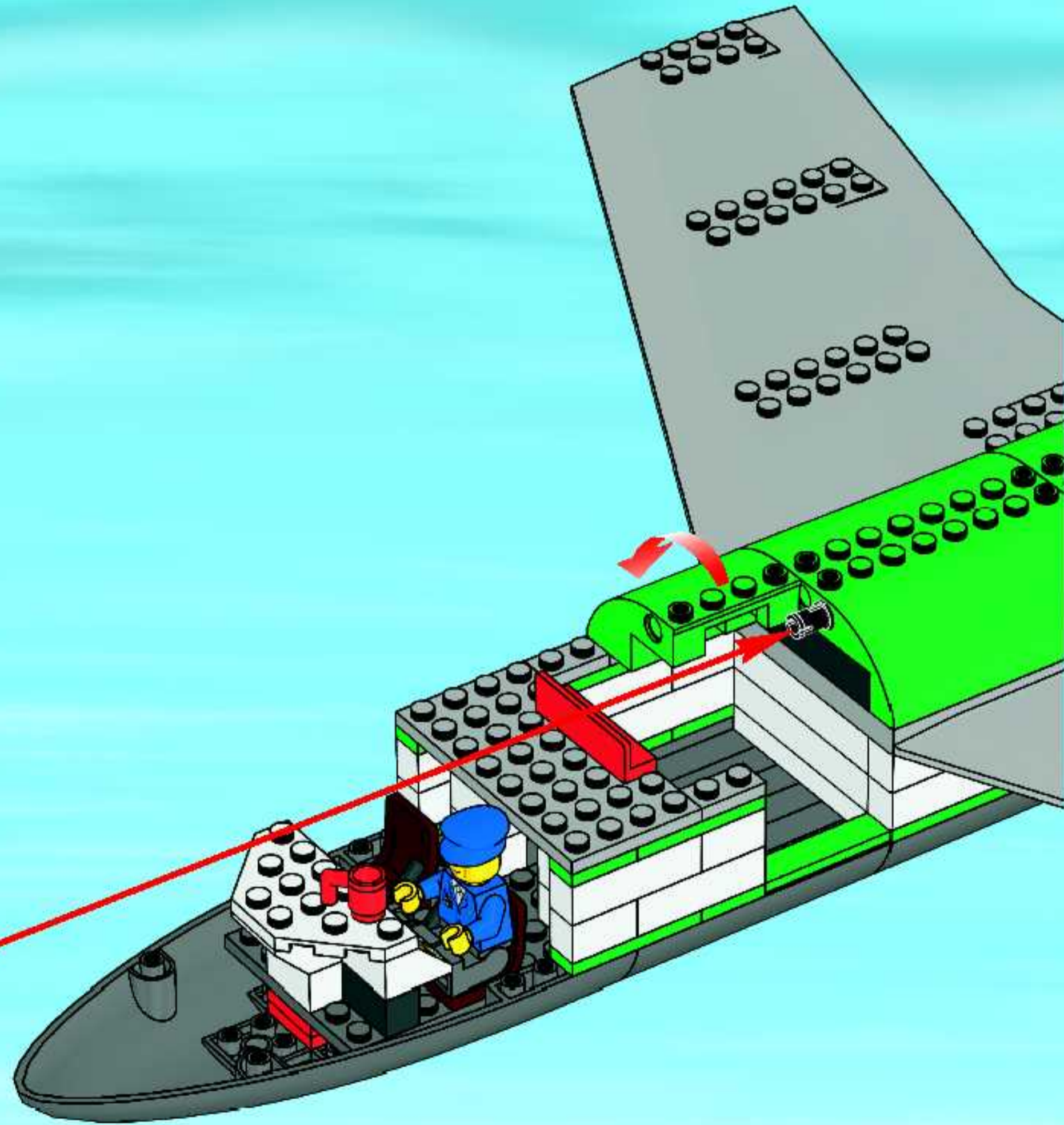
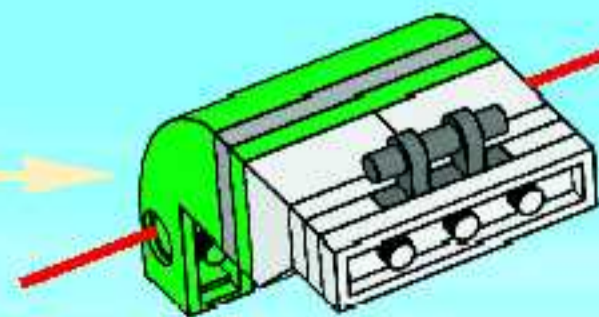



29

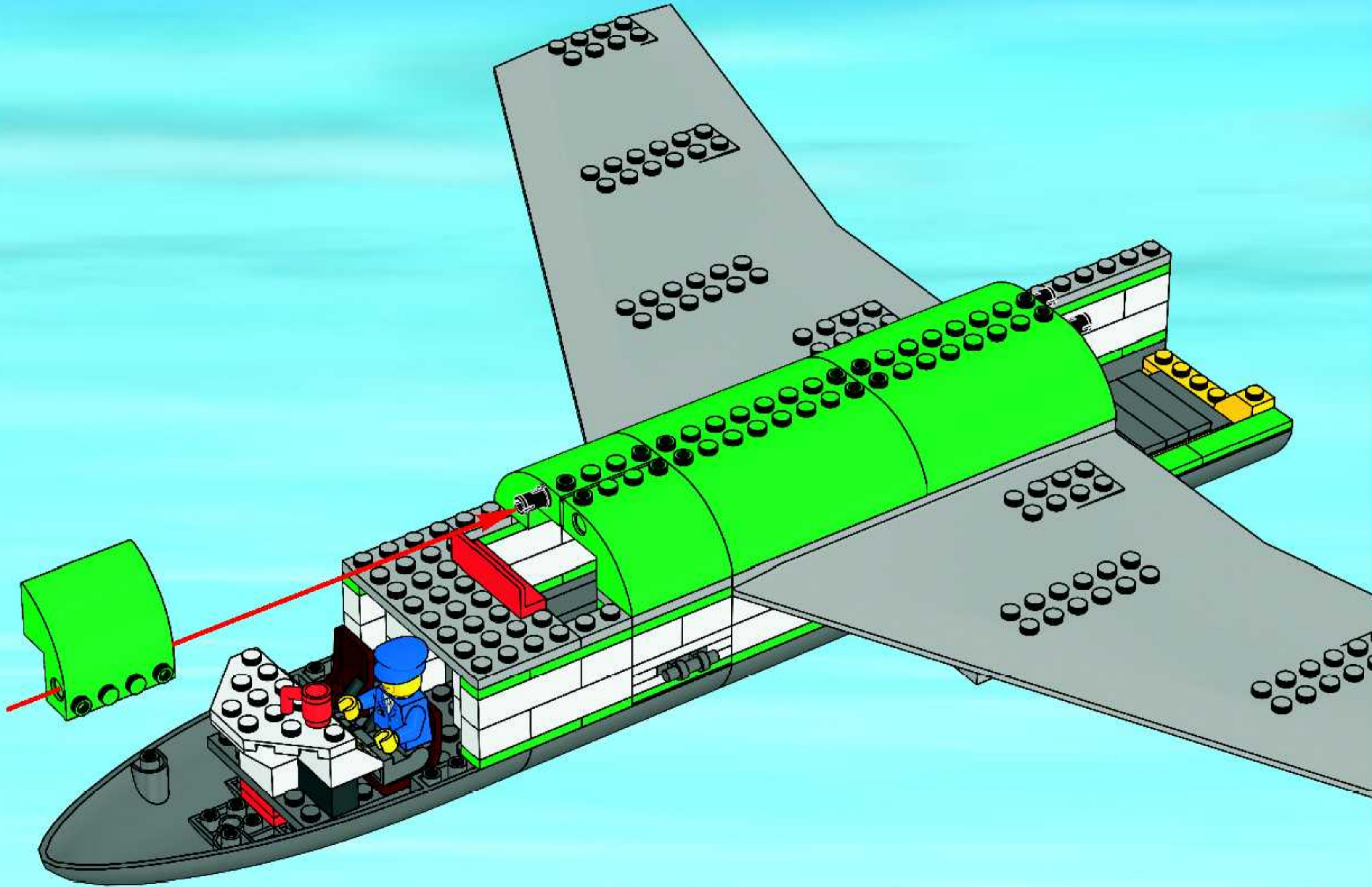

30

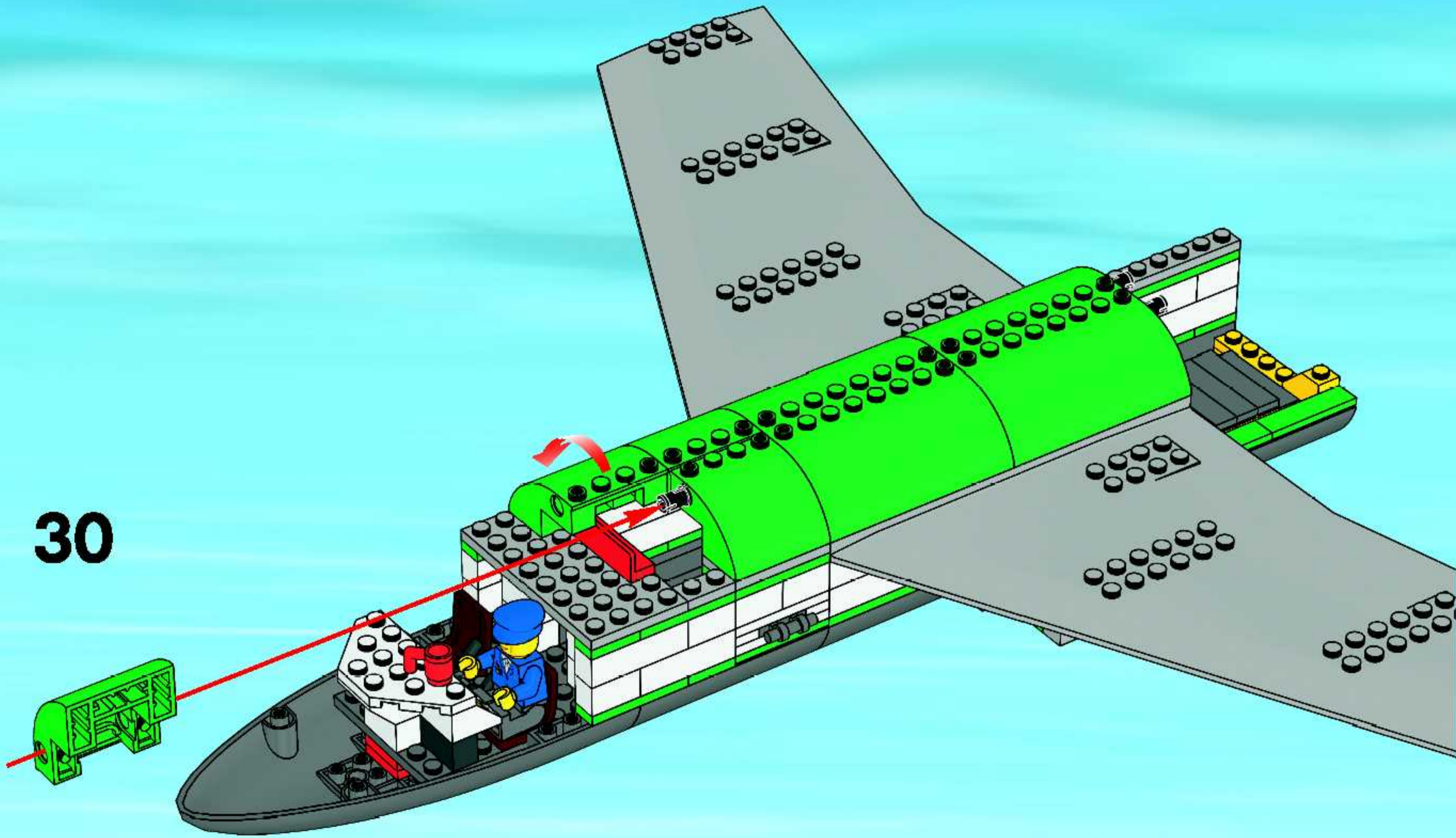

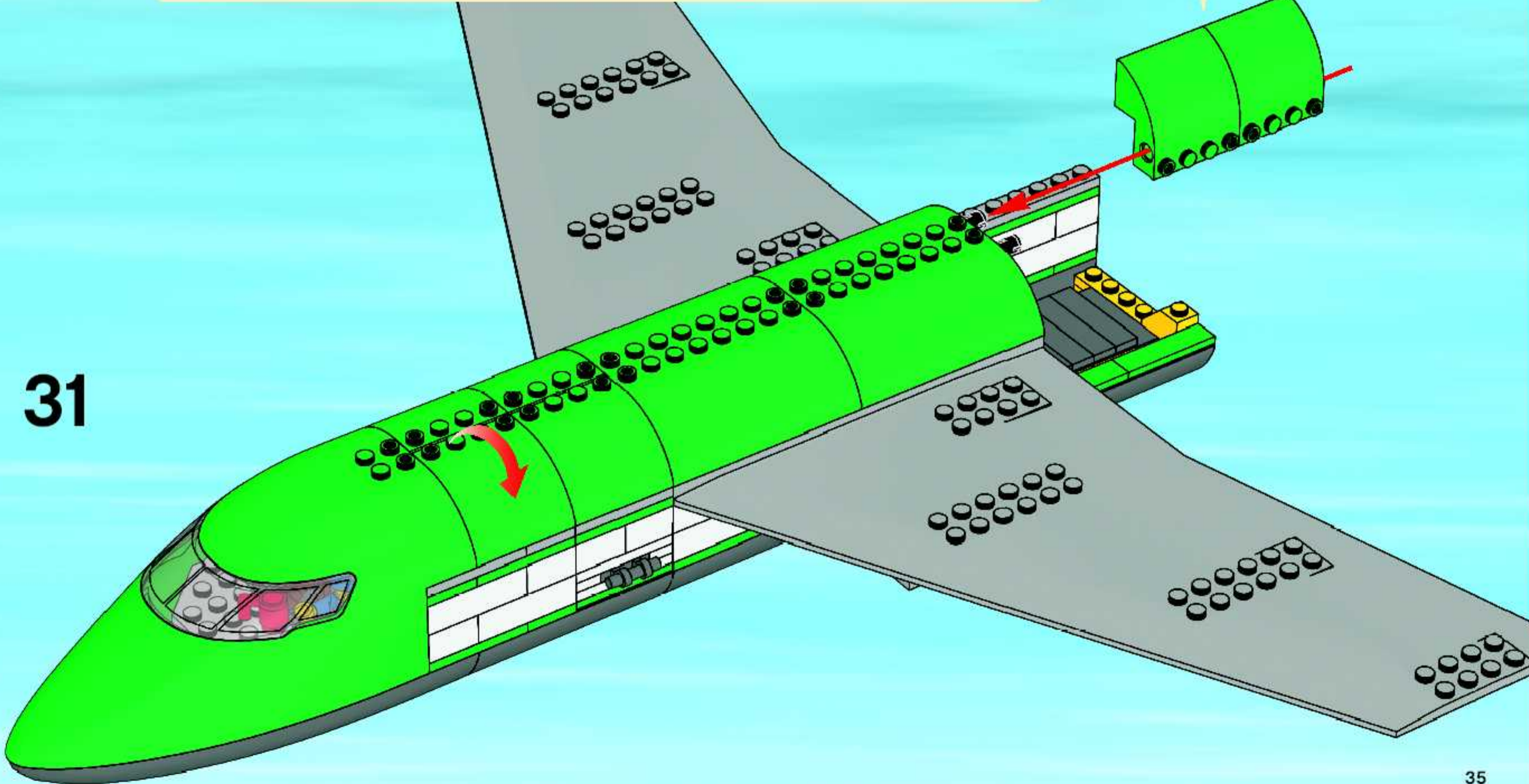
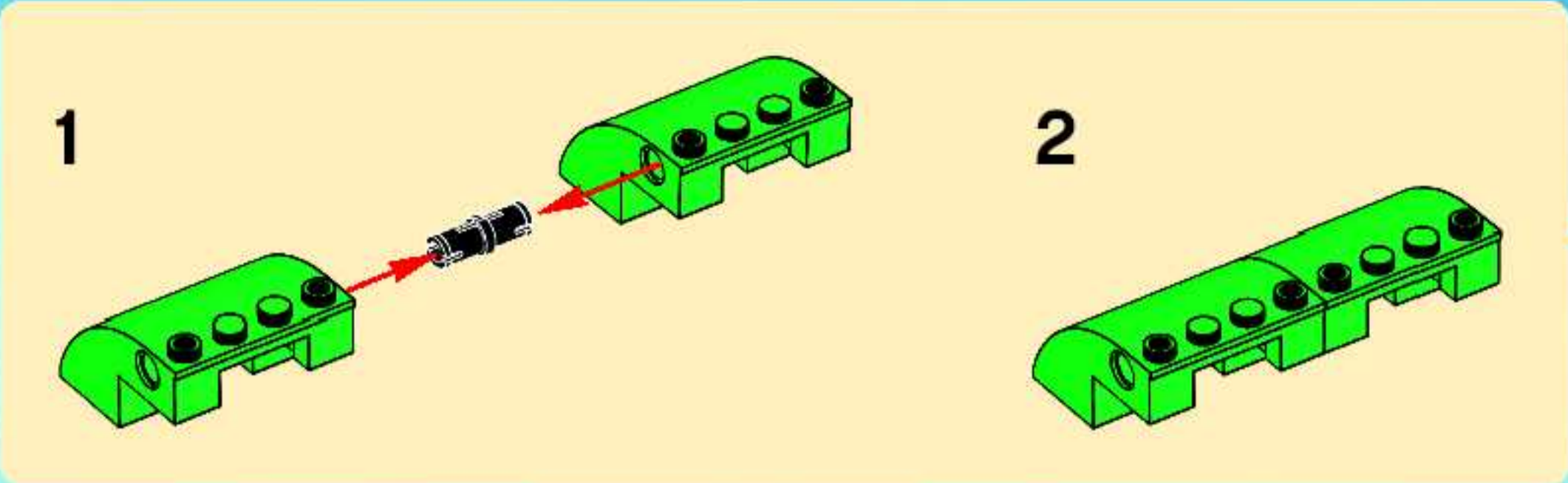

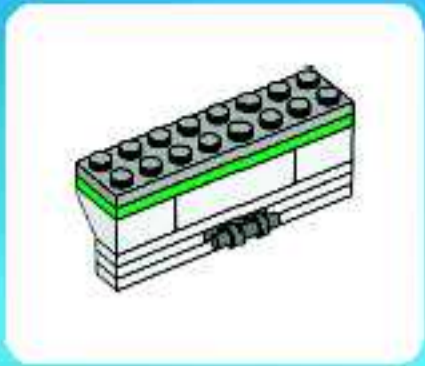

1

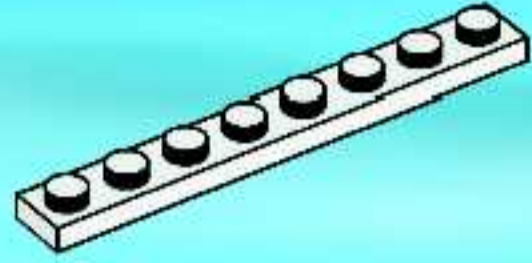

2

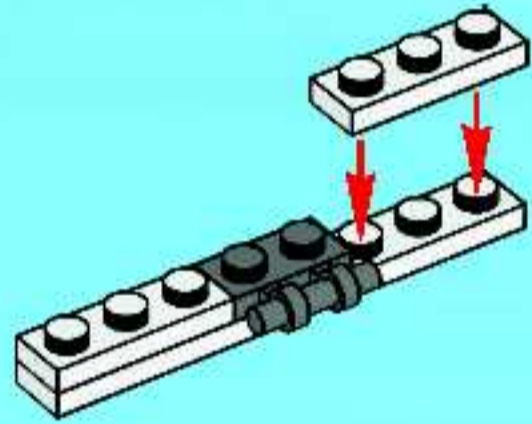

3

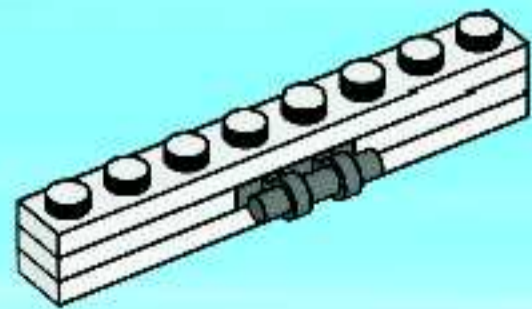

4

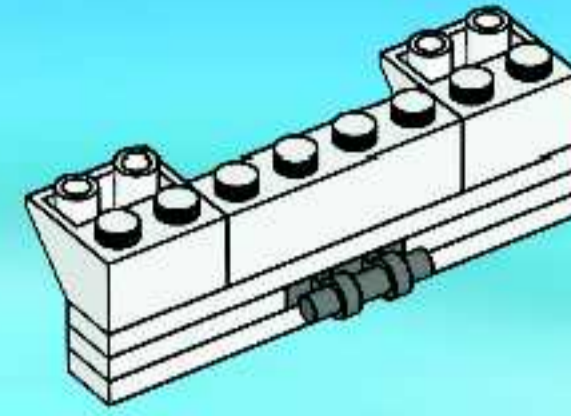

5

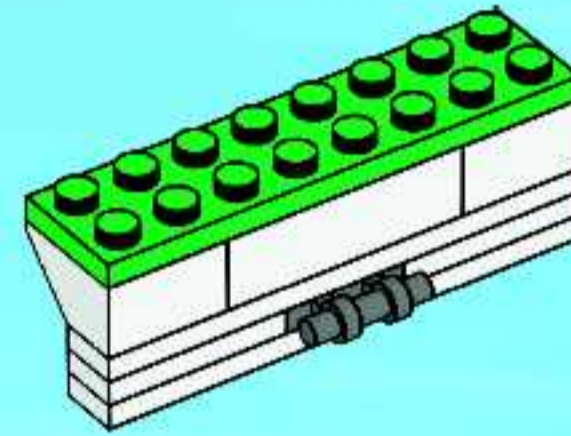

6

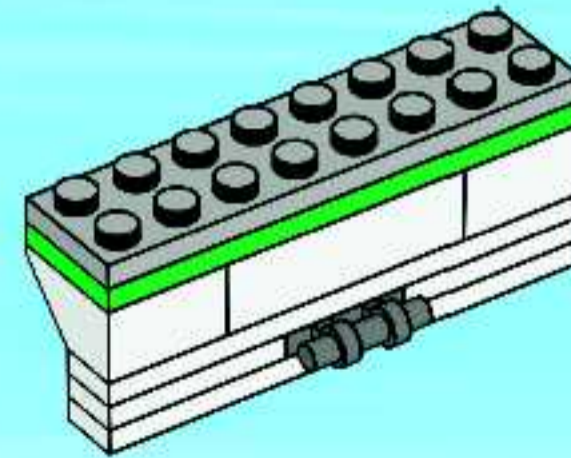

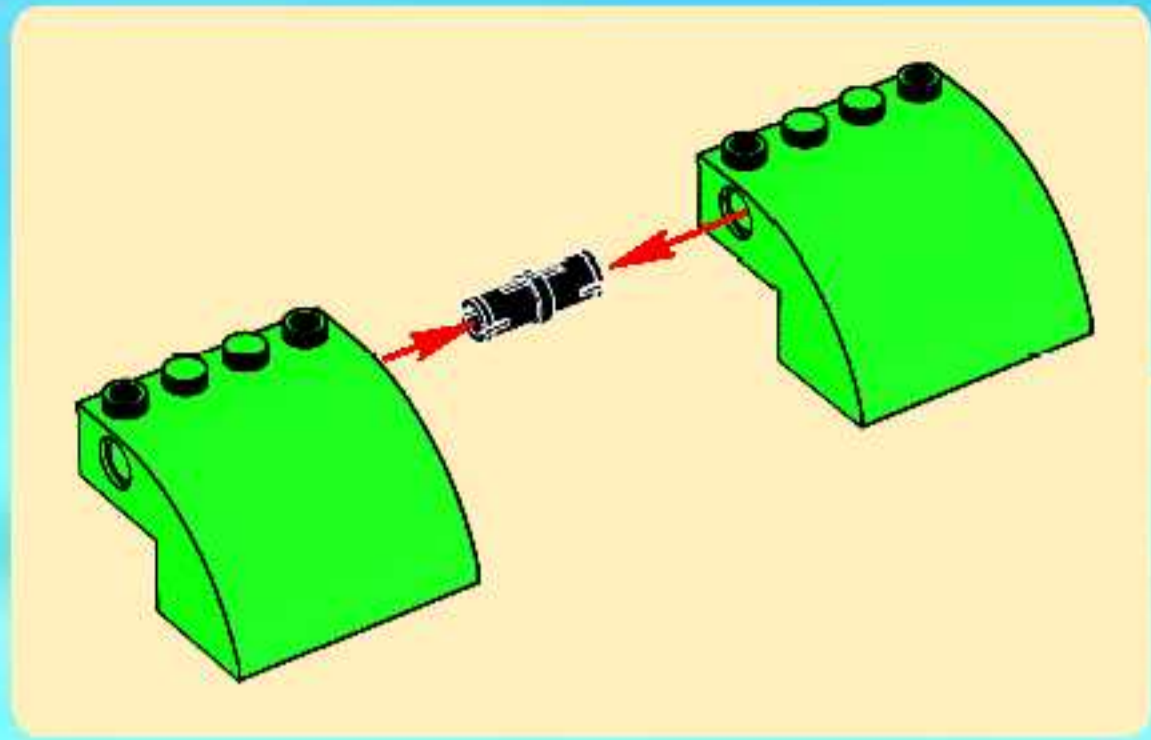

7

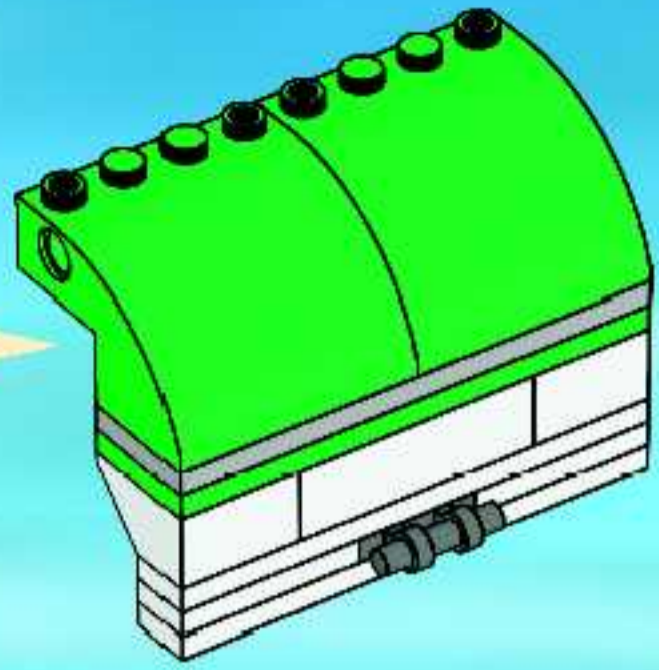

32

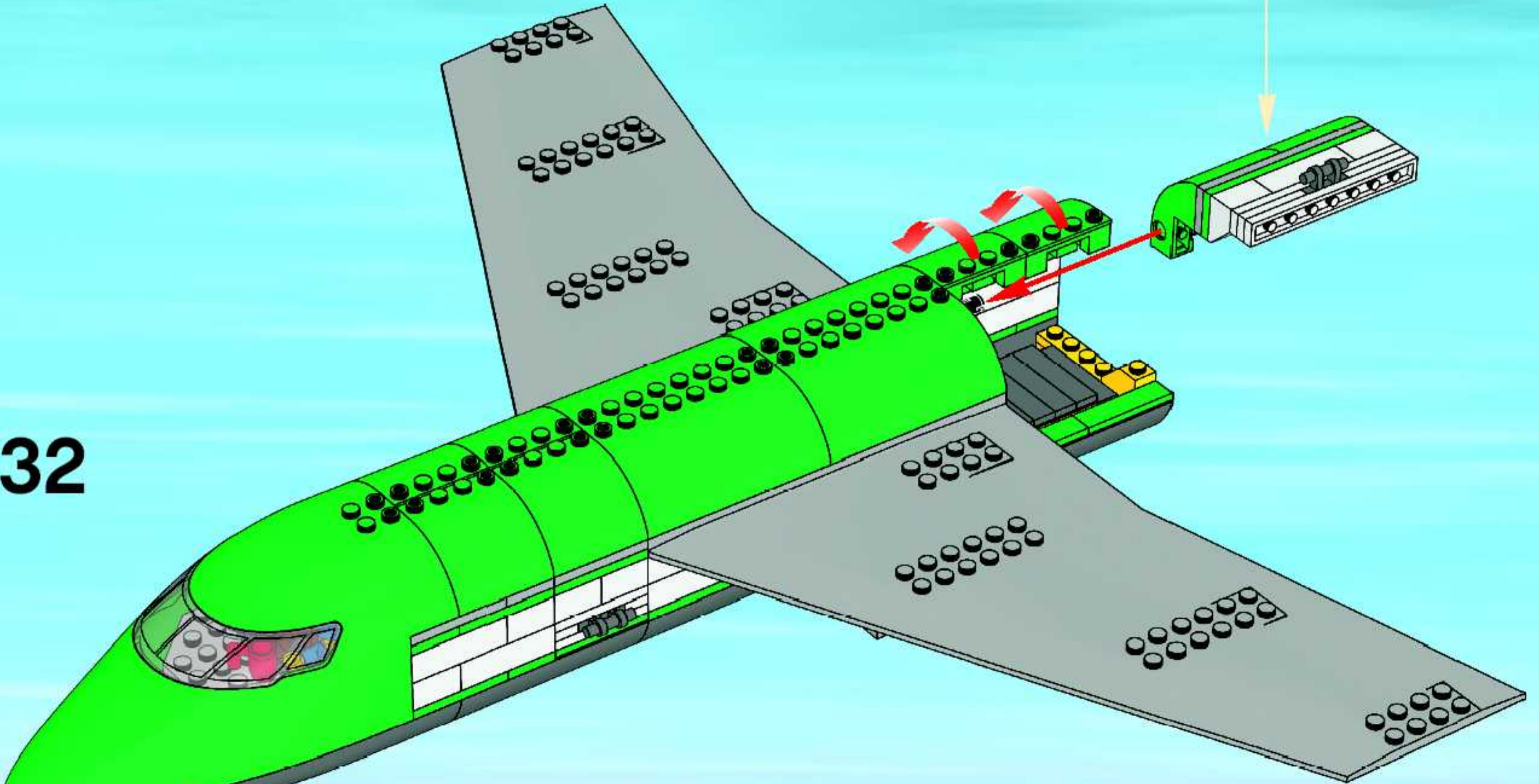

33

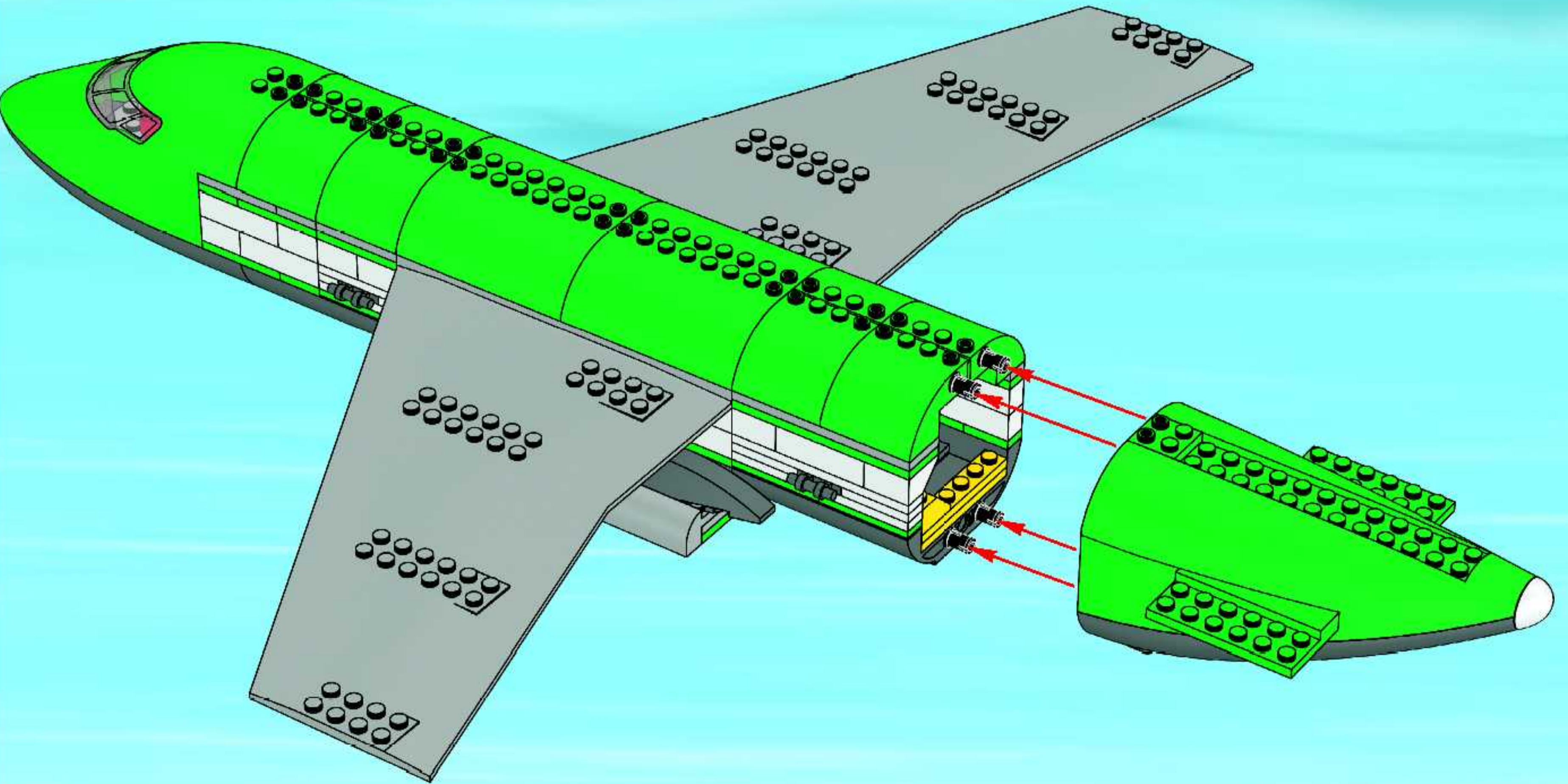

34

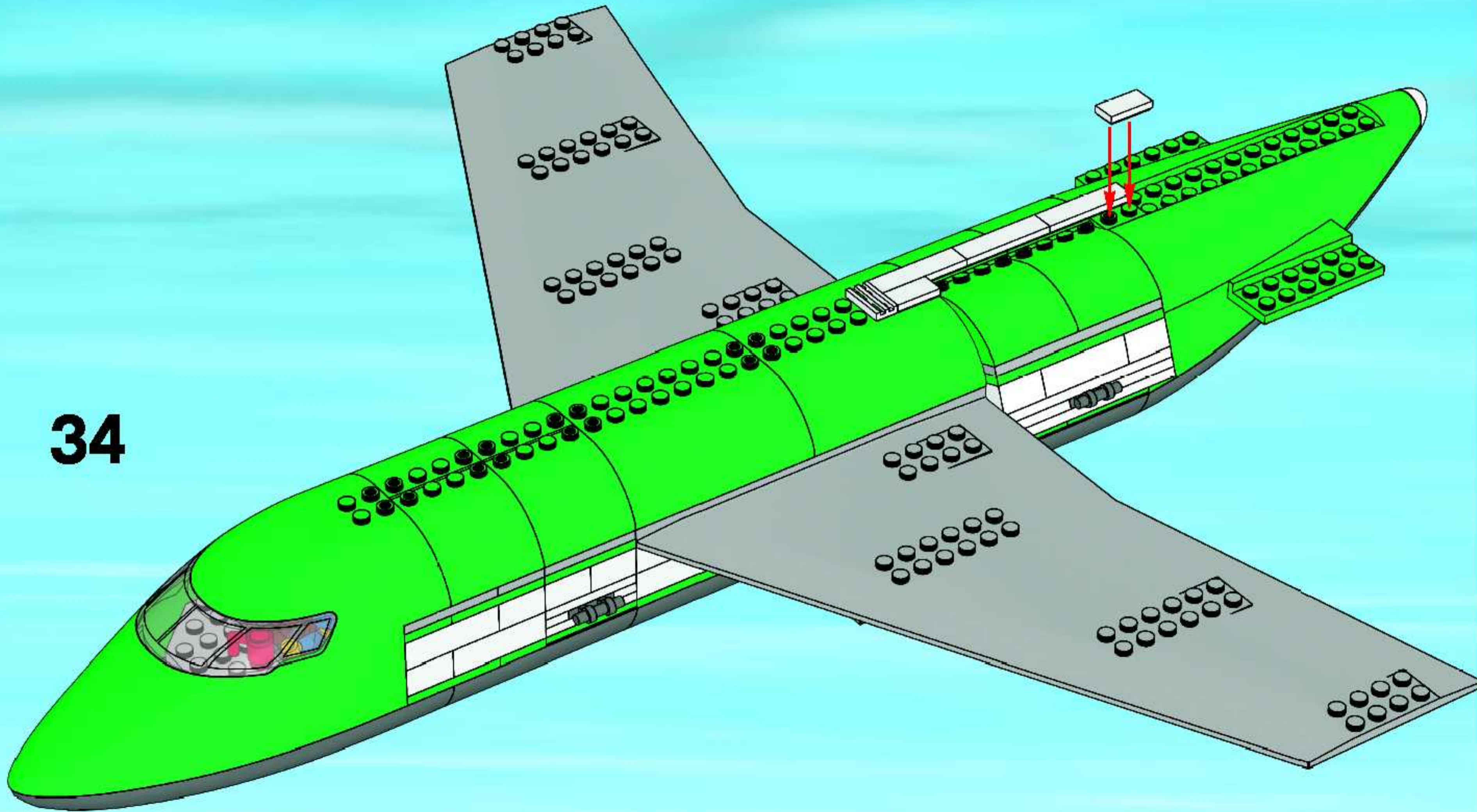

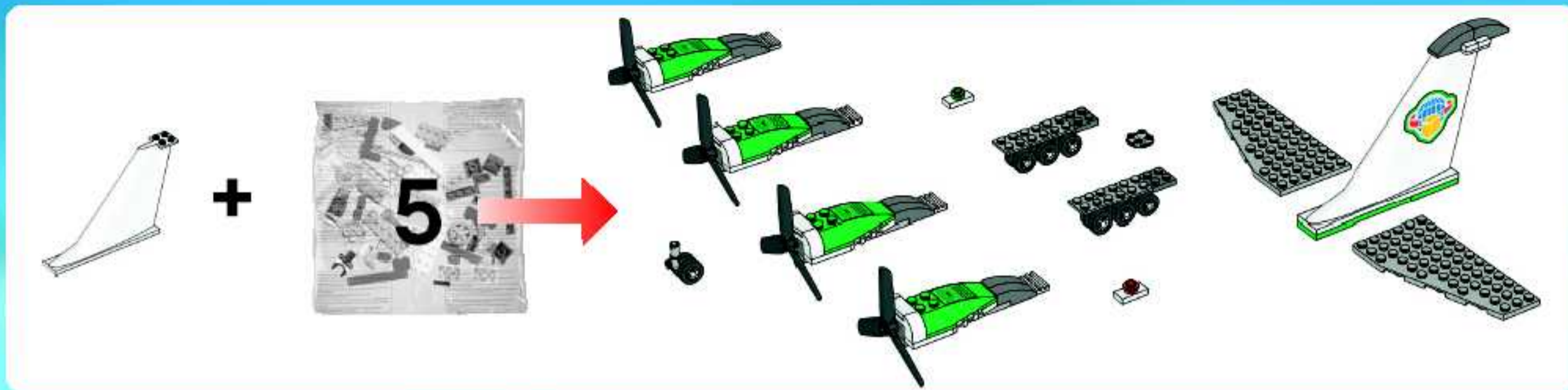

35

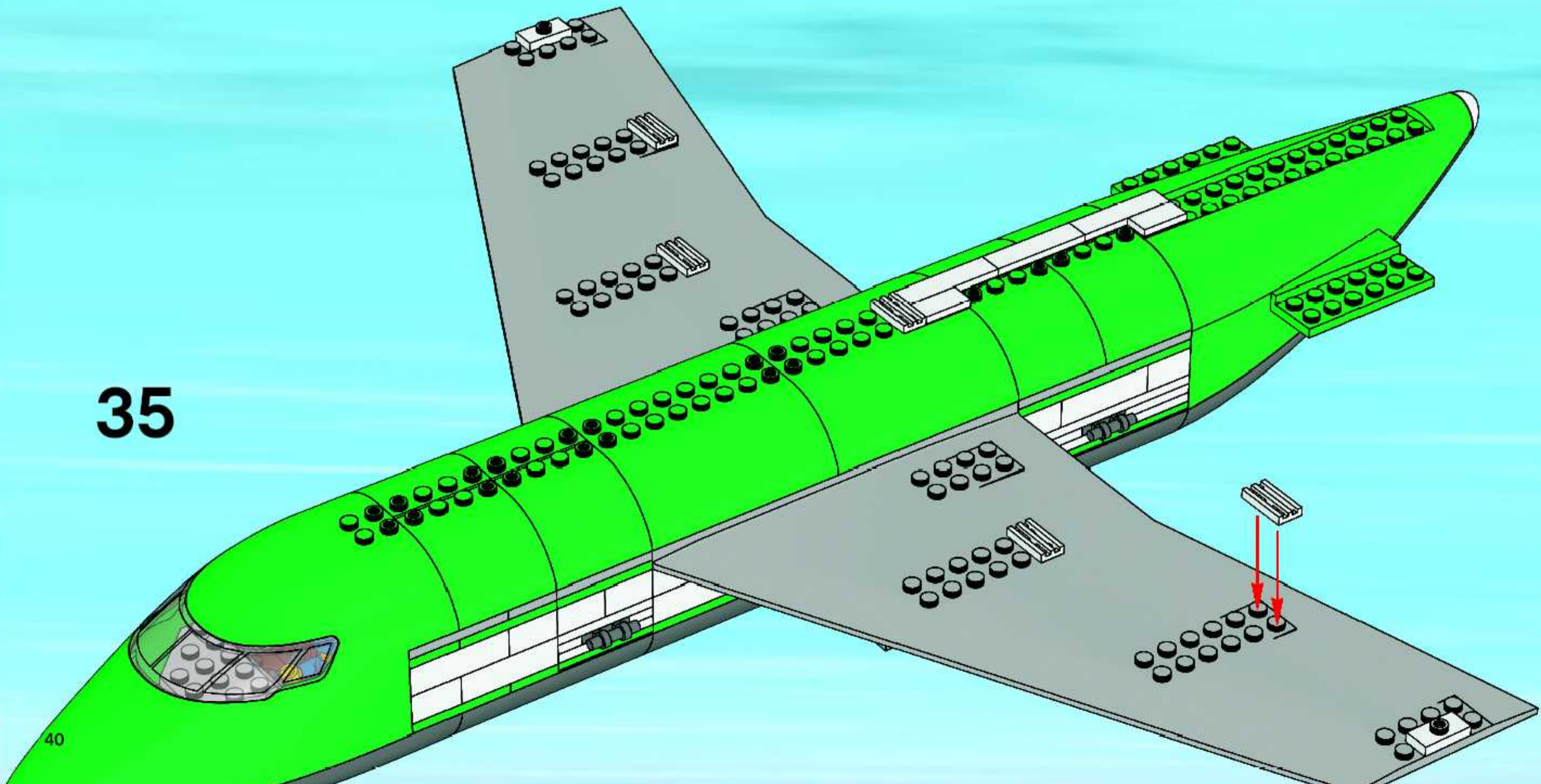



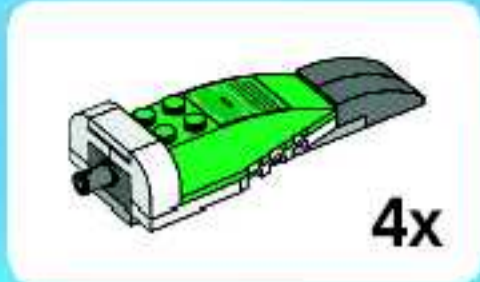

1

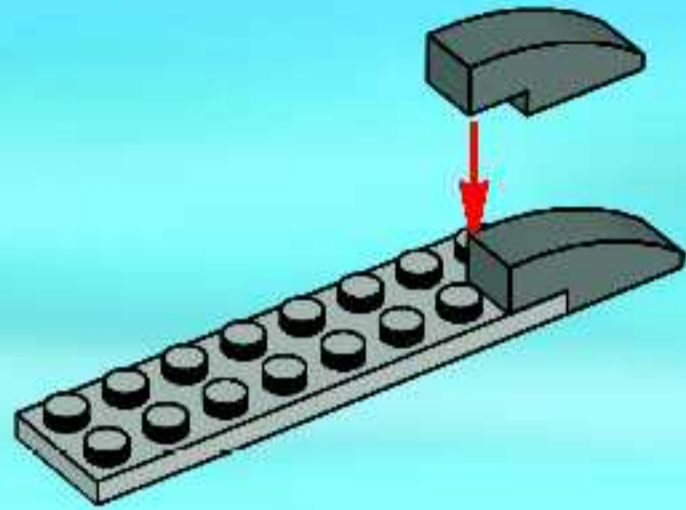

2

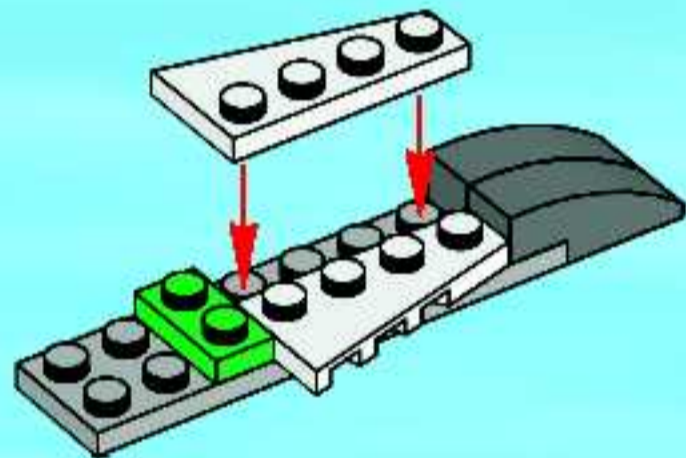

3

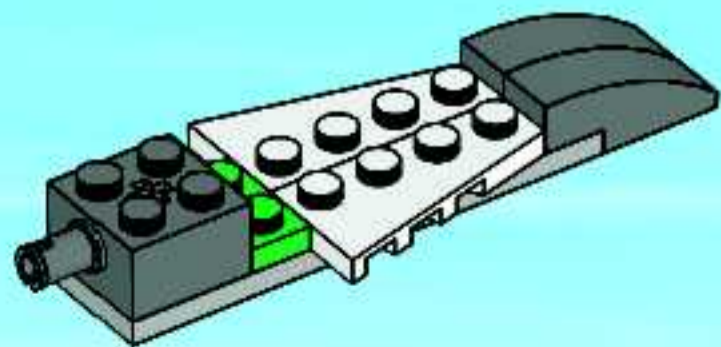

4

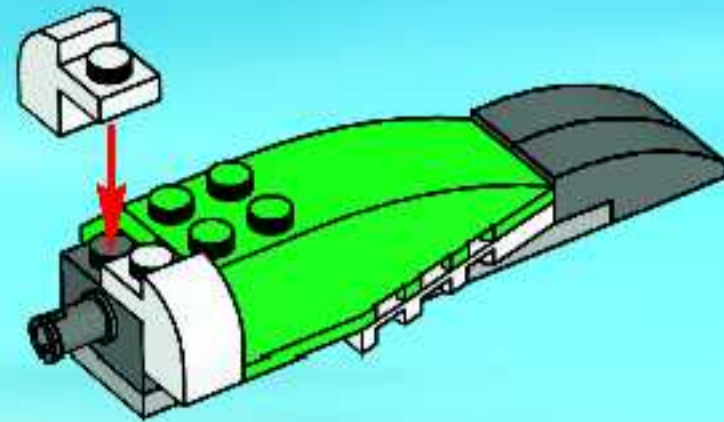

5

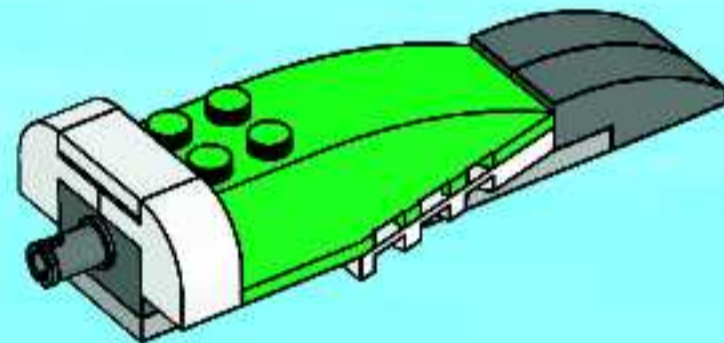

6

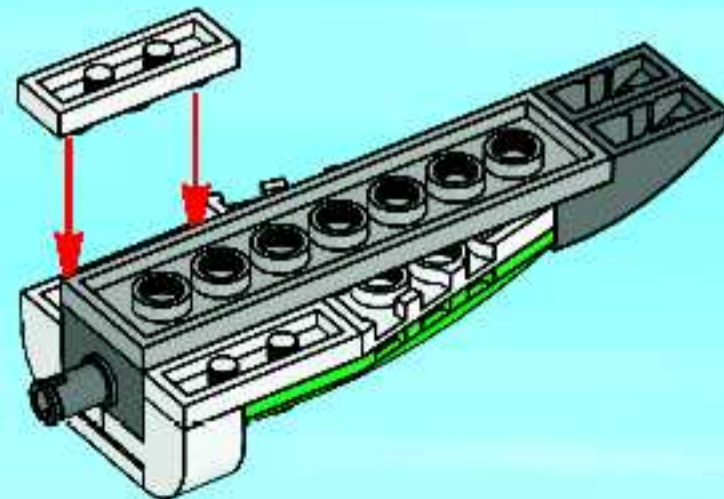

7

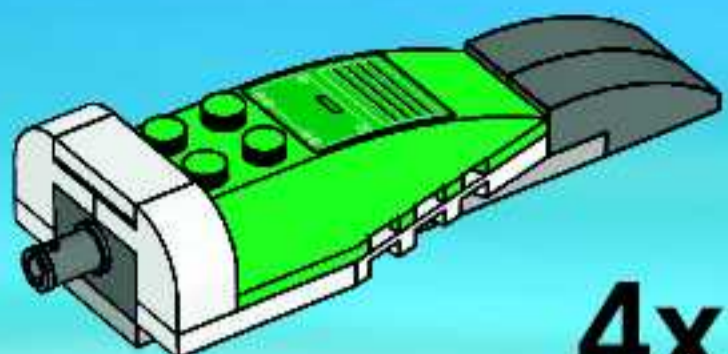

4x

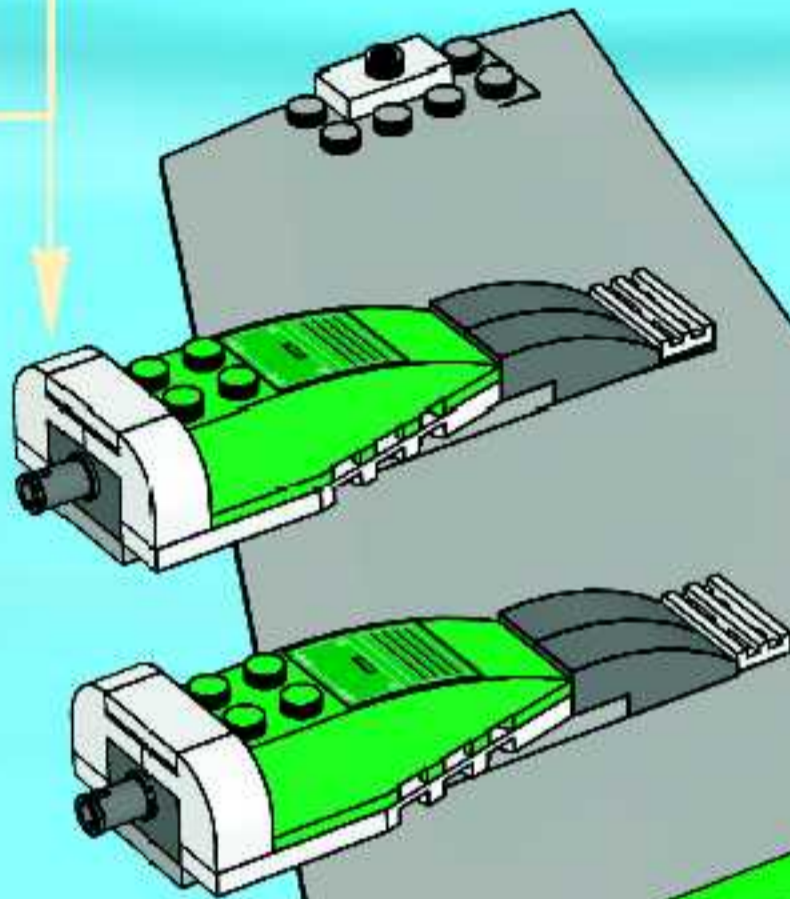

36

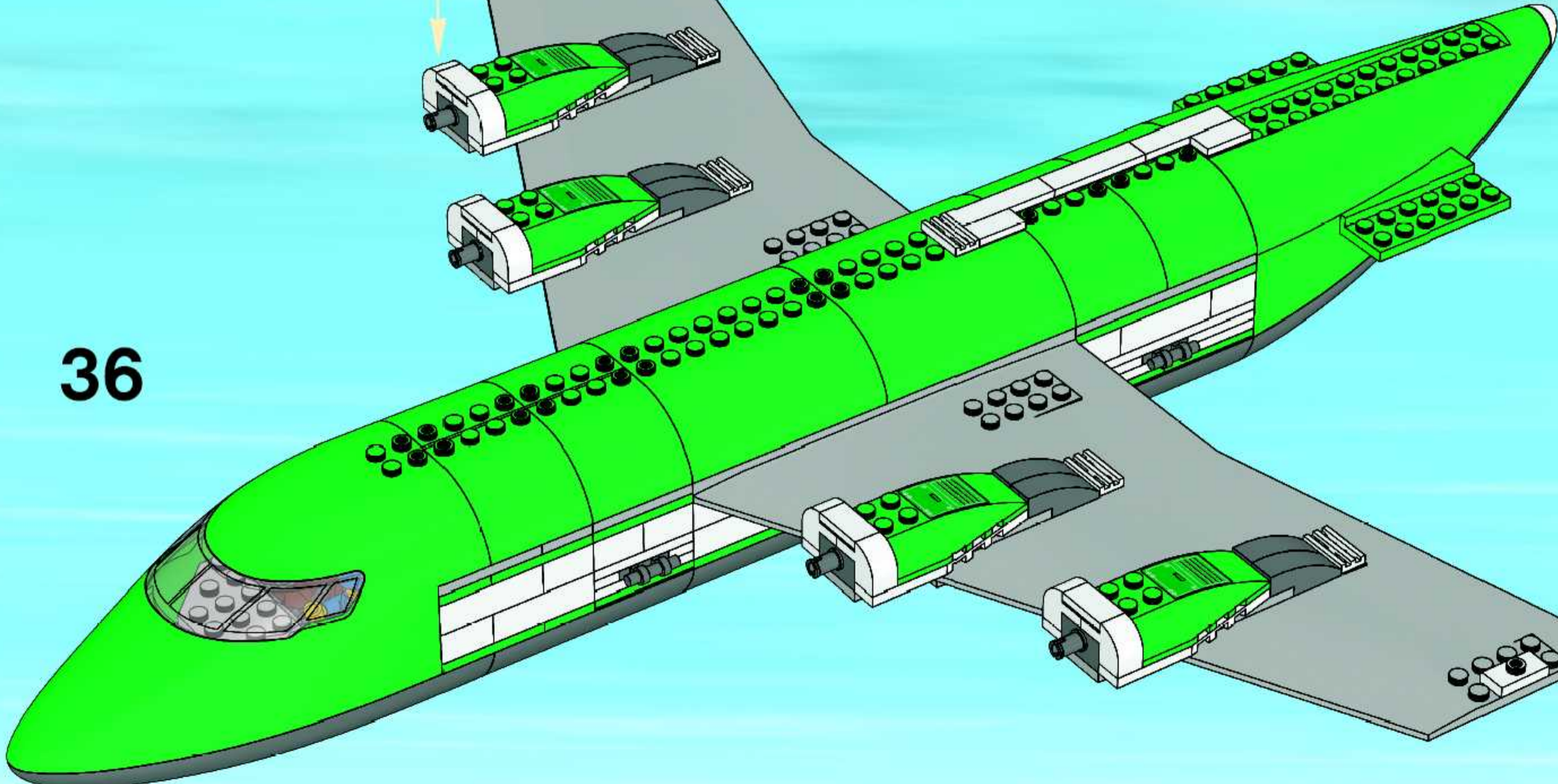

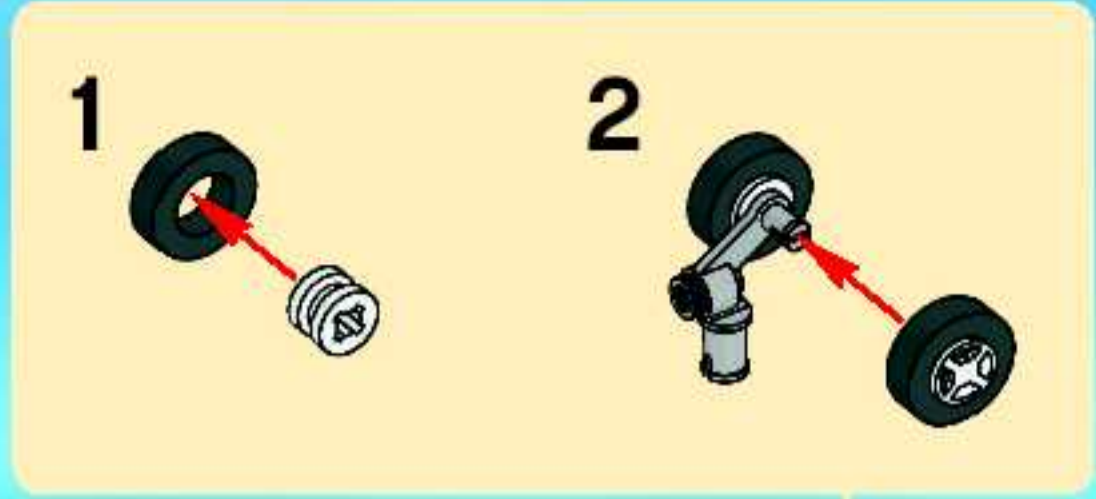

37

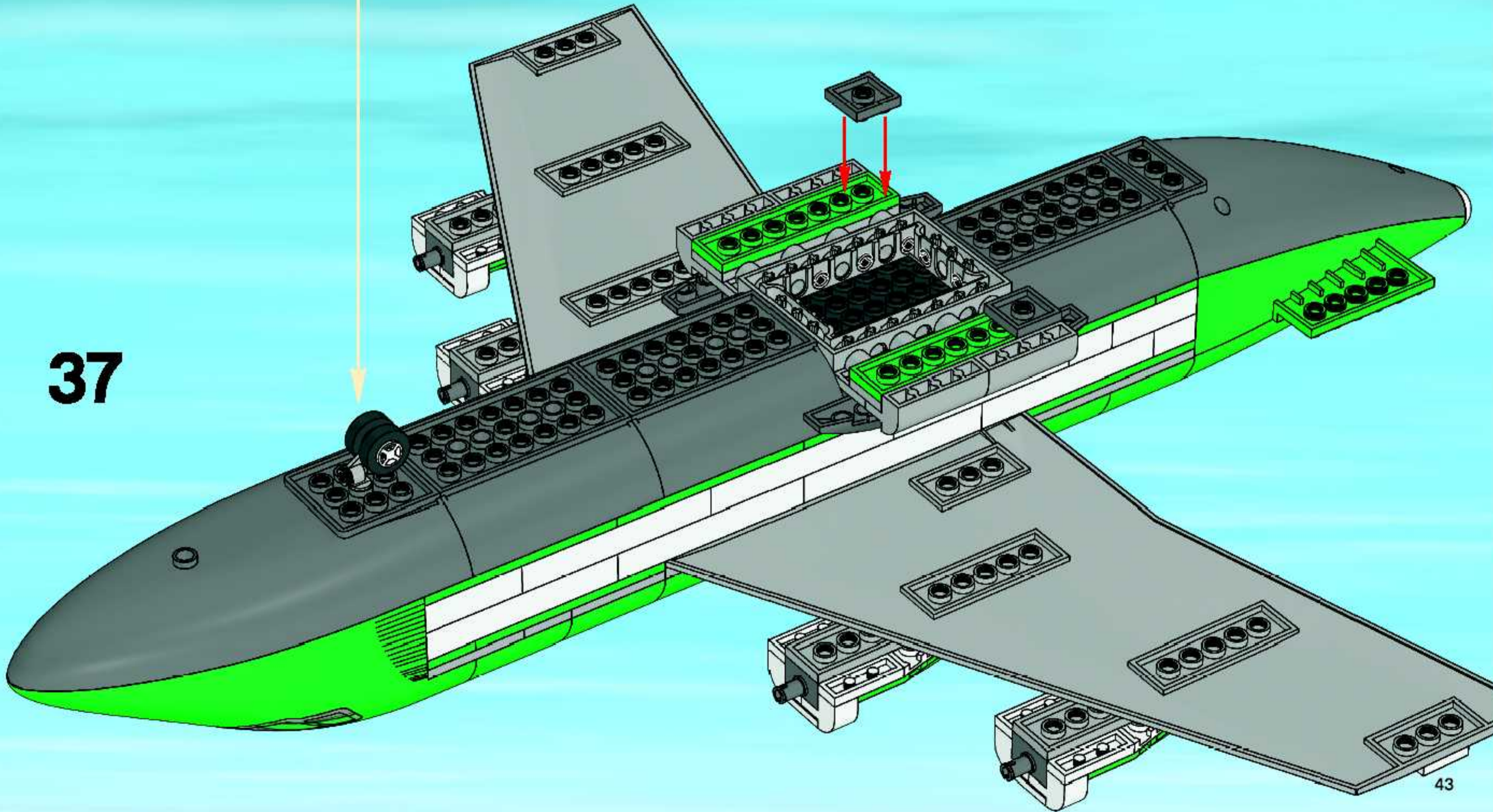

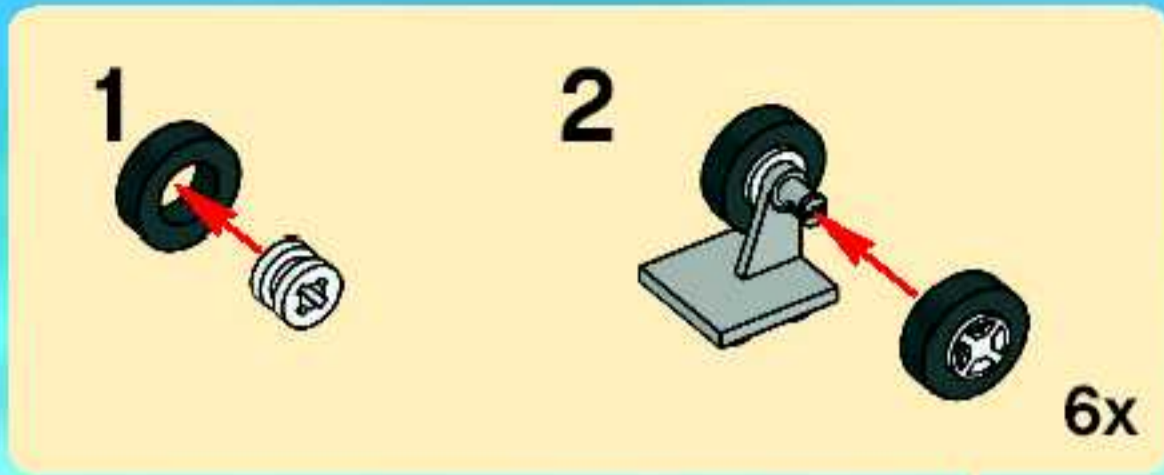

38

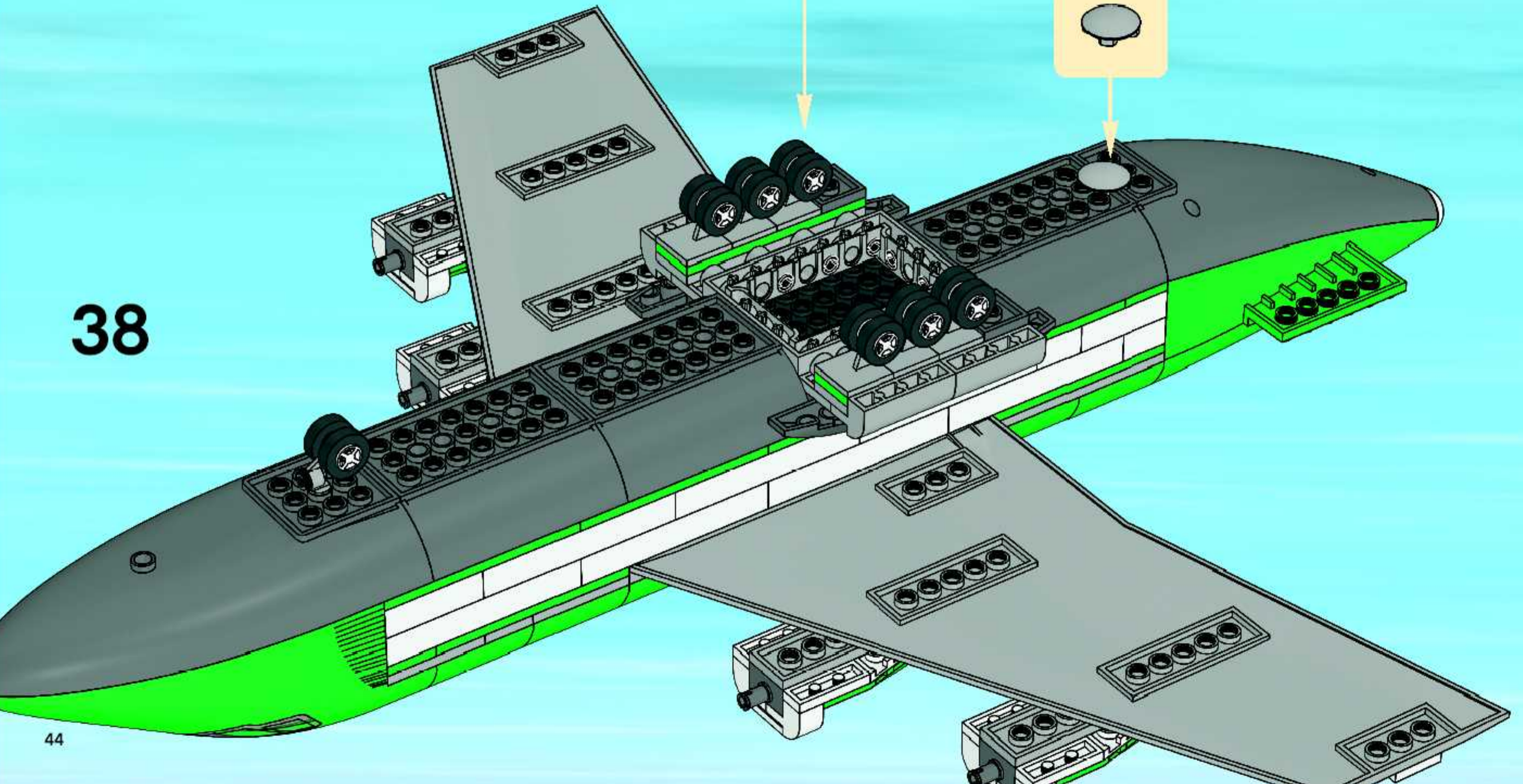

39

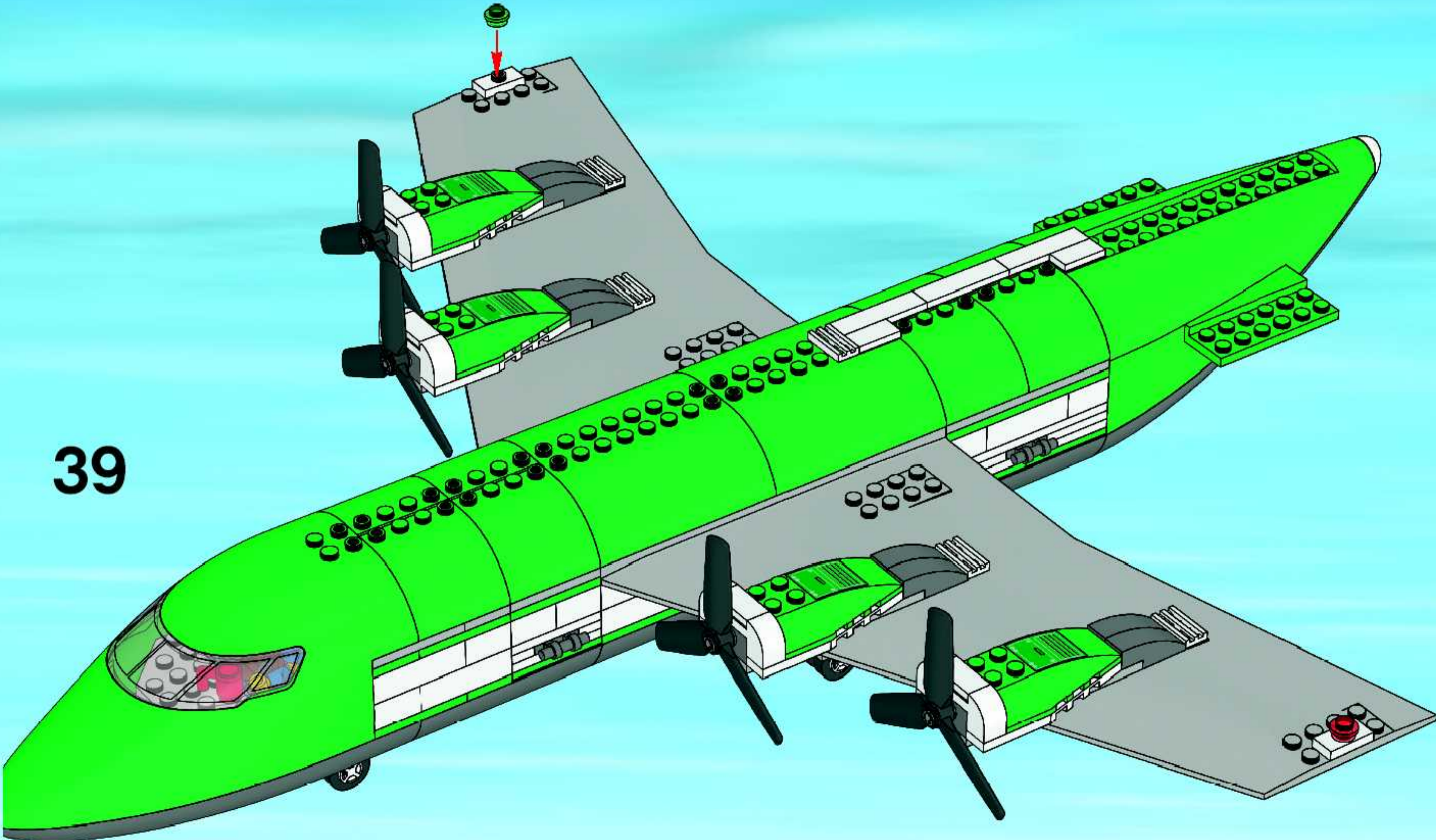

1

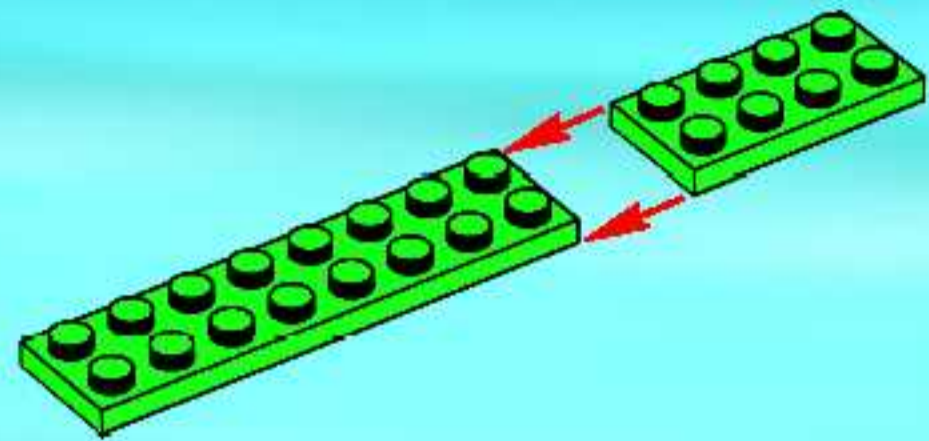

2

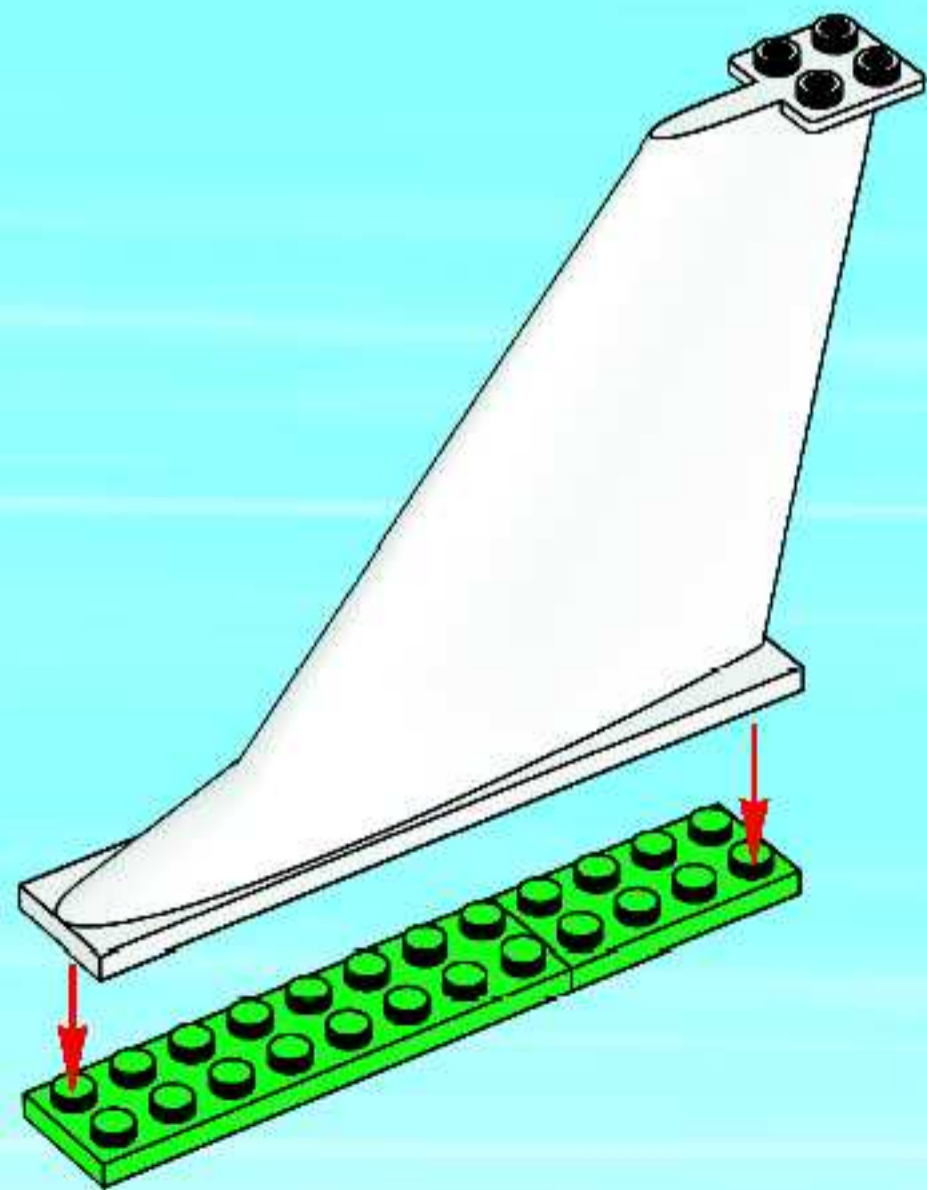

3

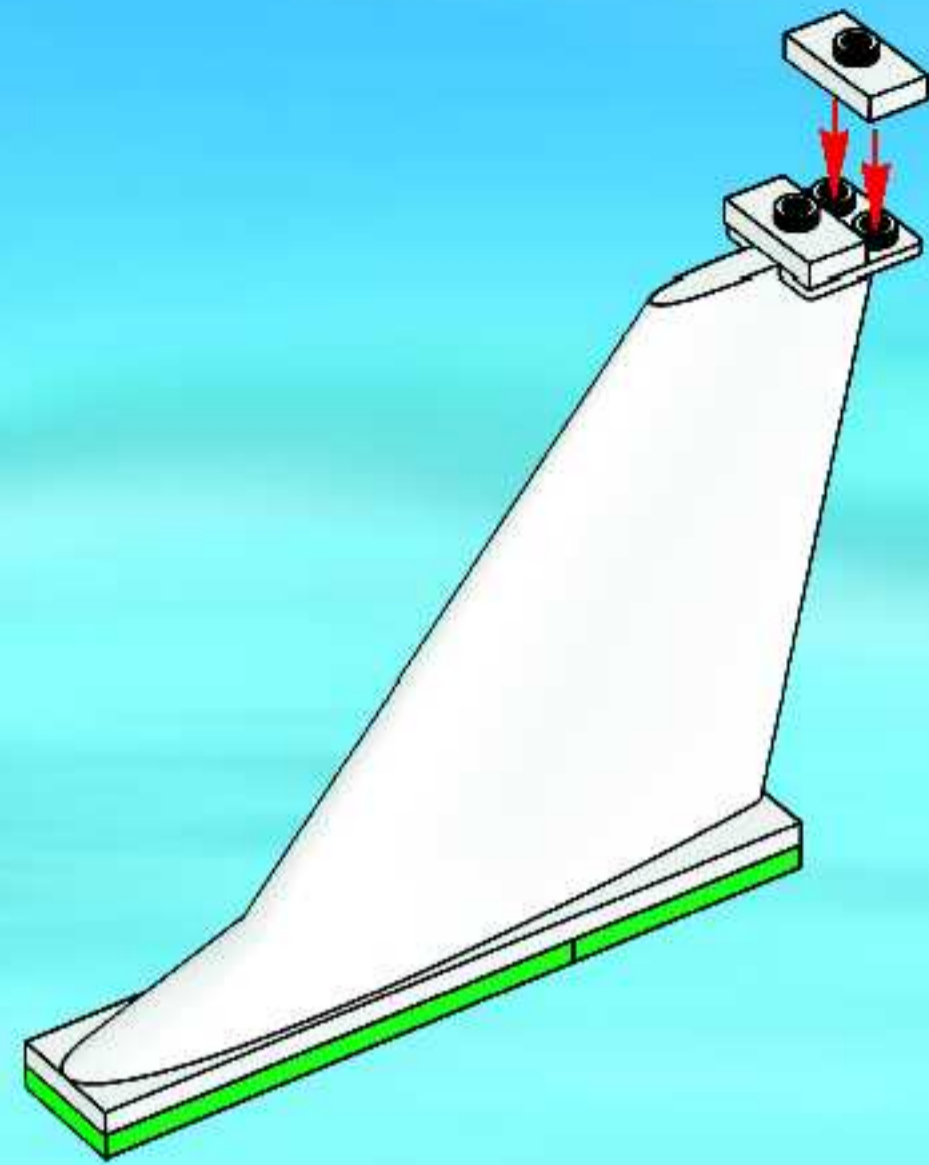

4

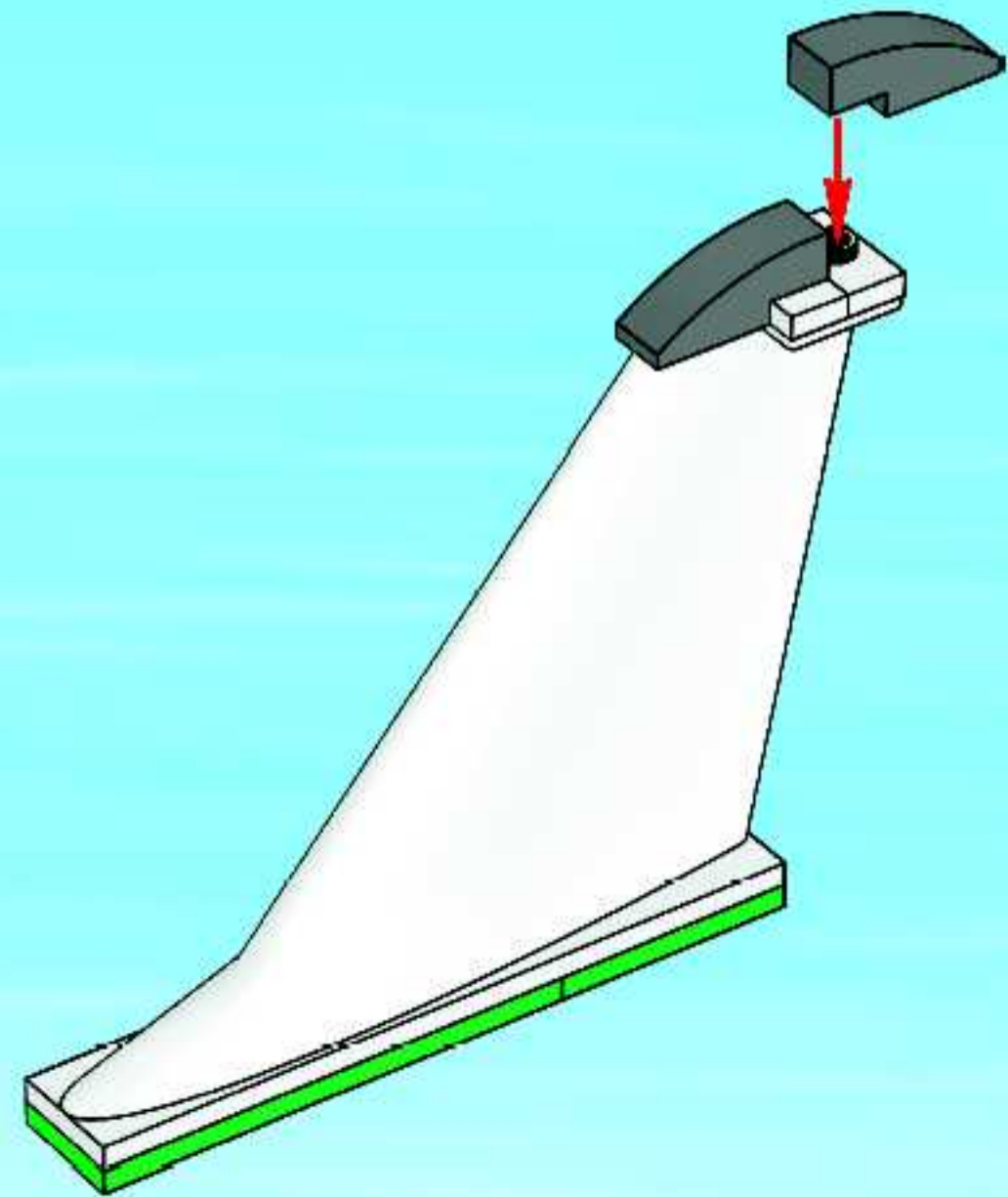

5



40

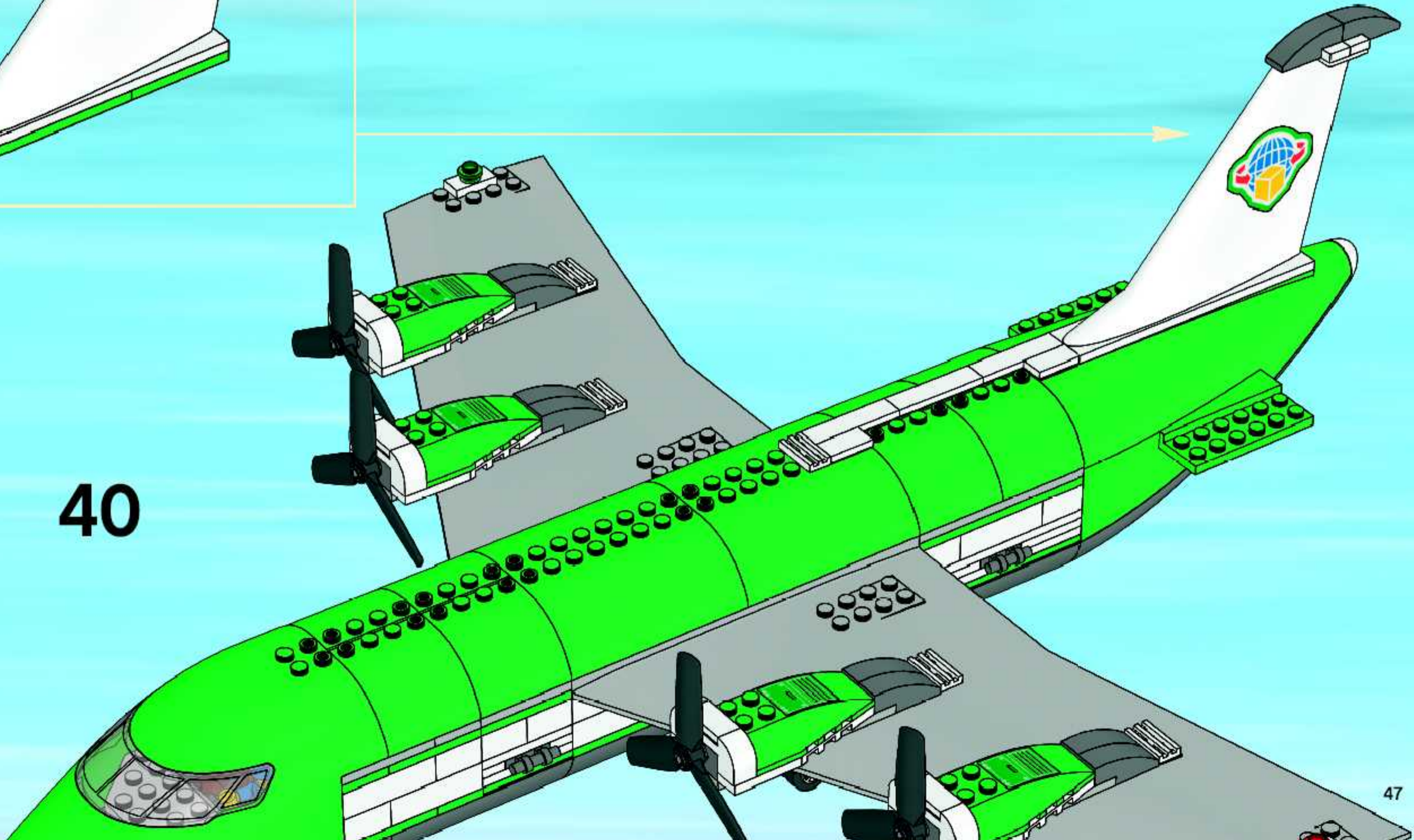

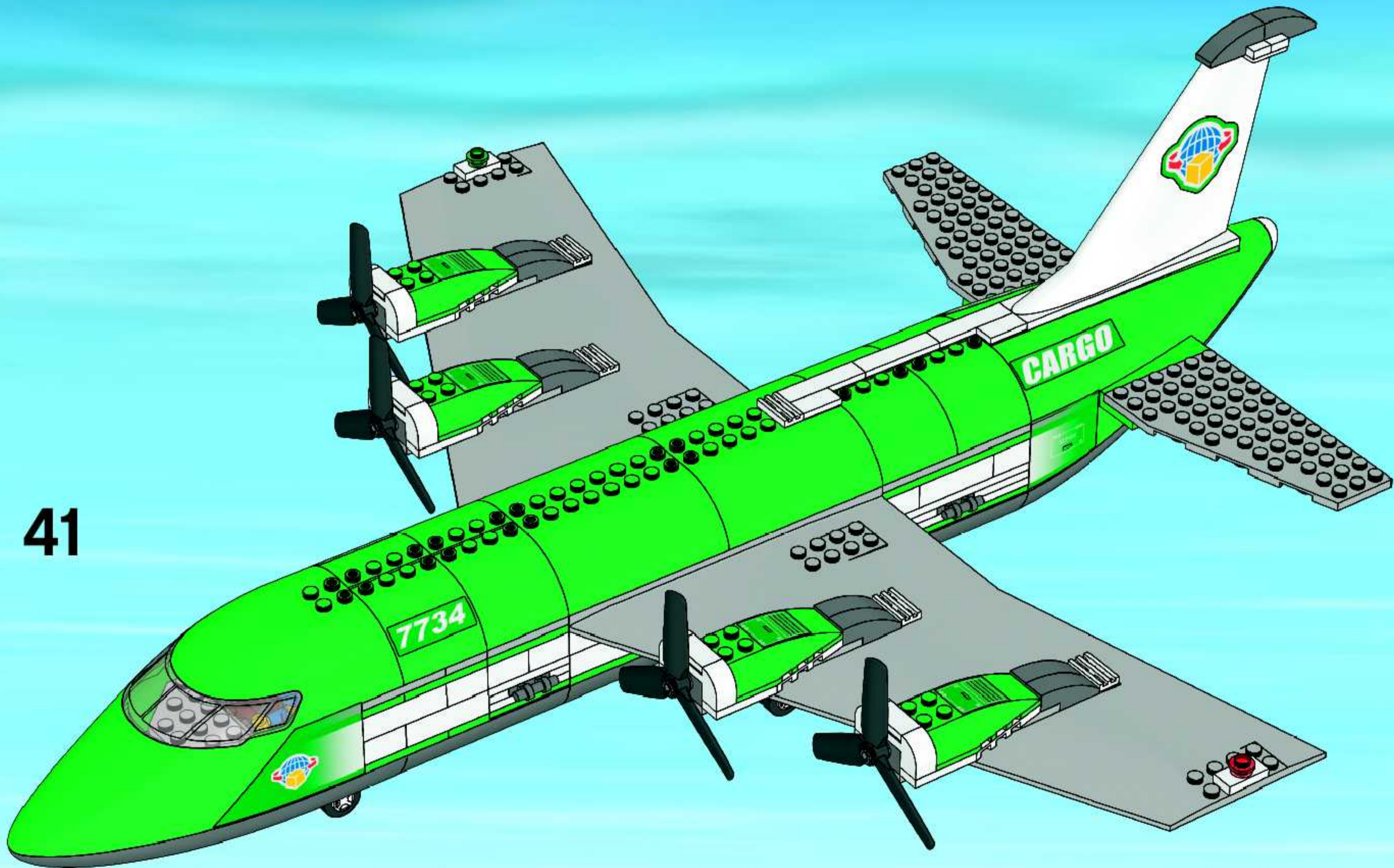

41



42

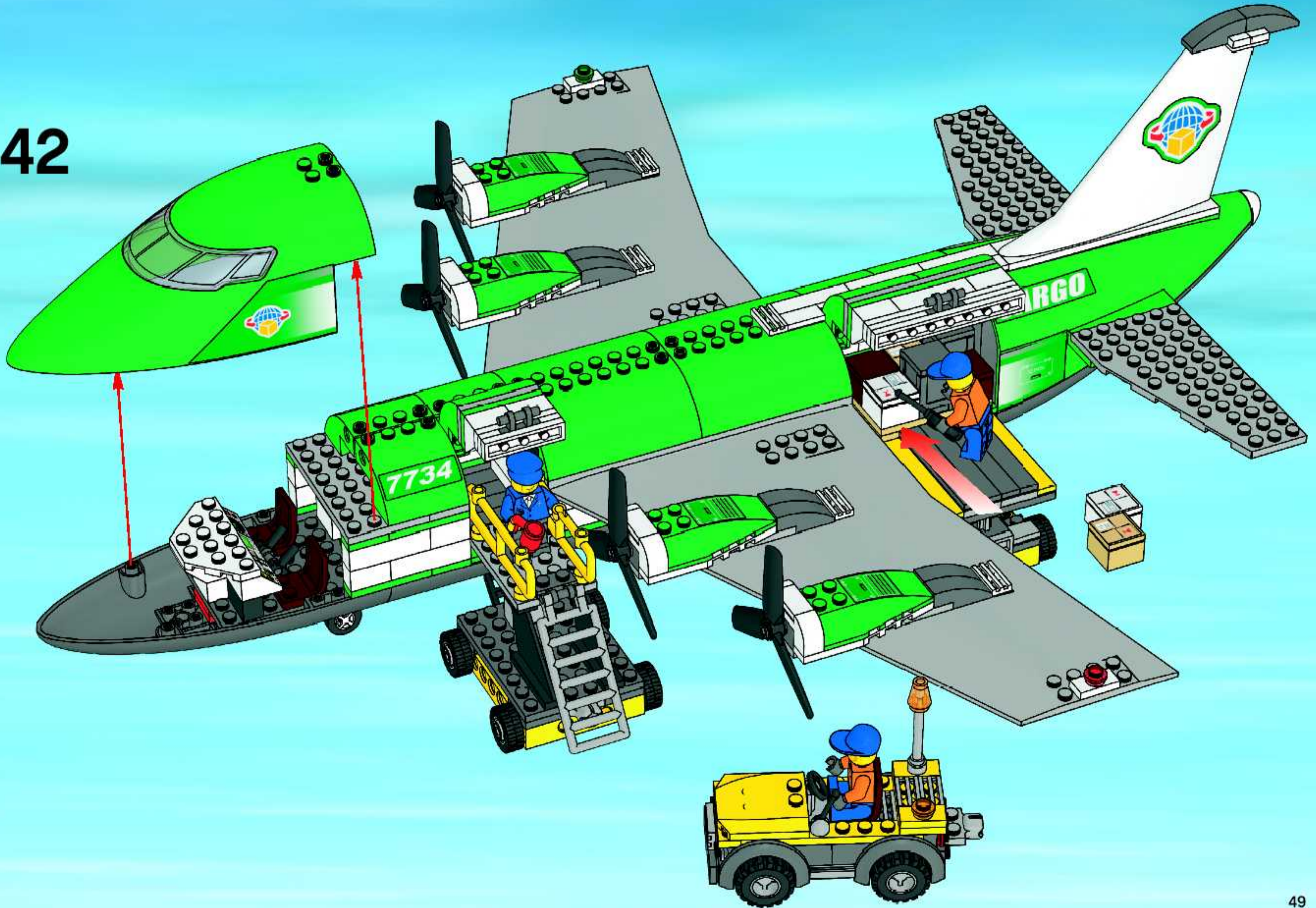

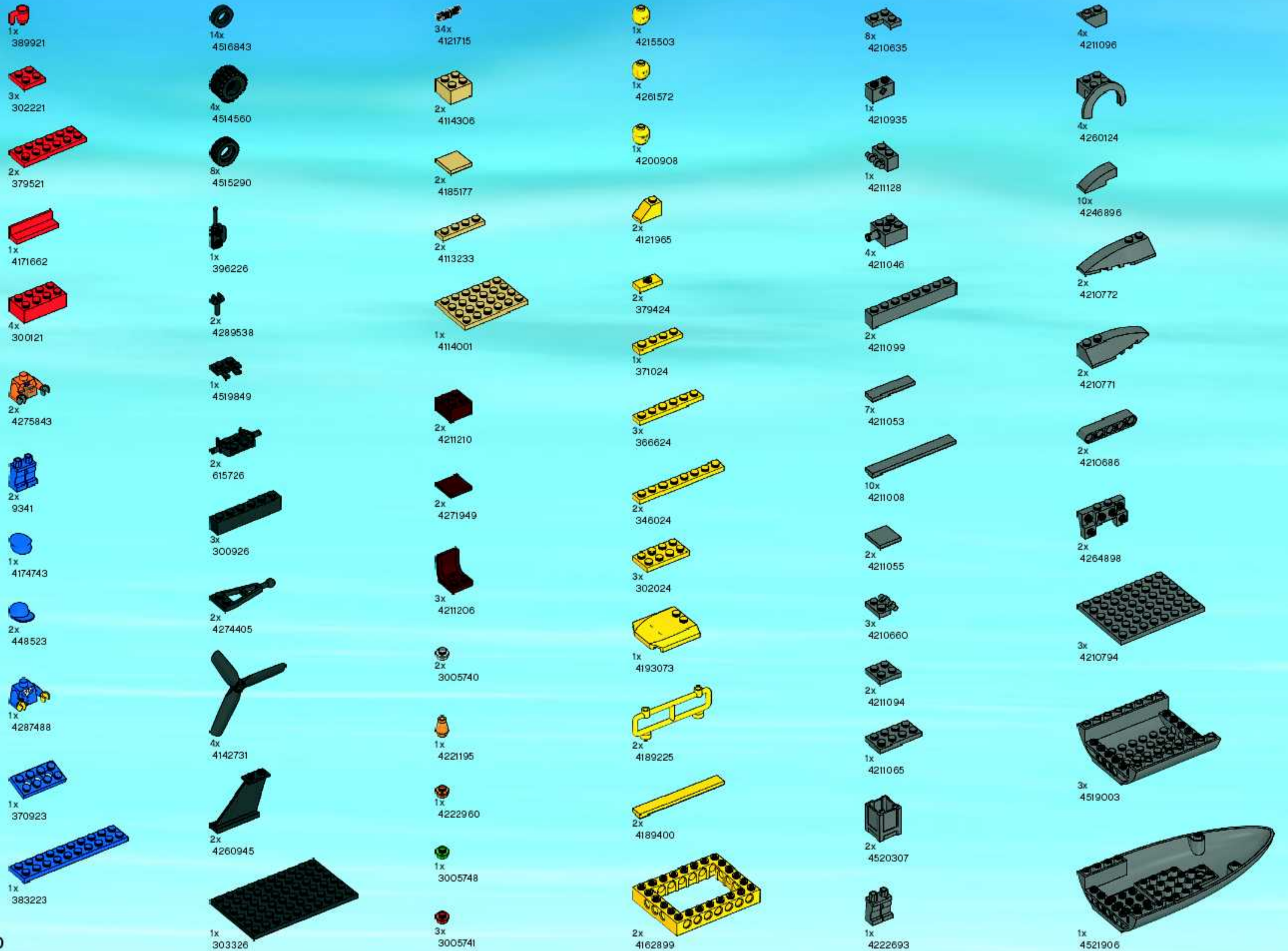

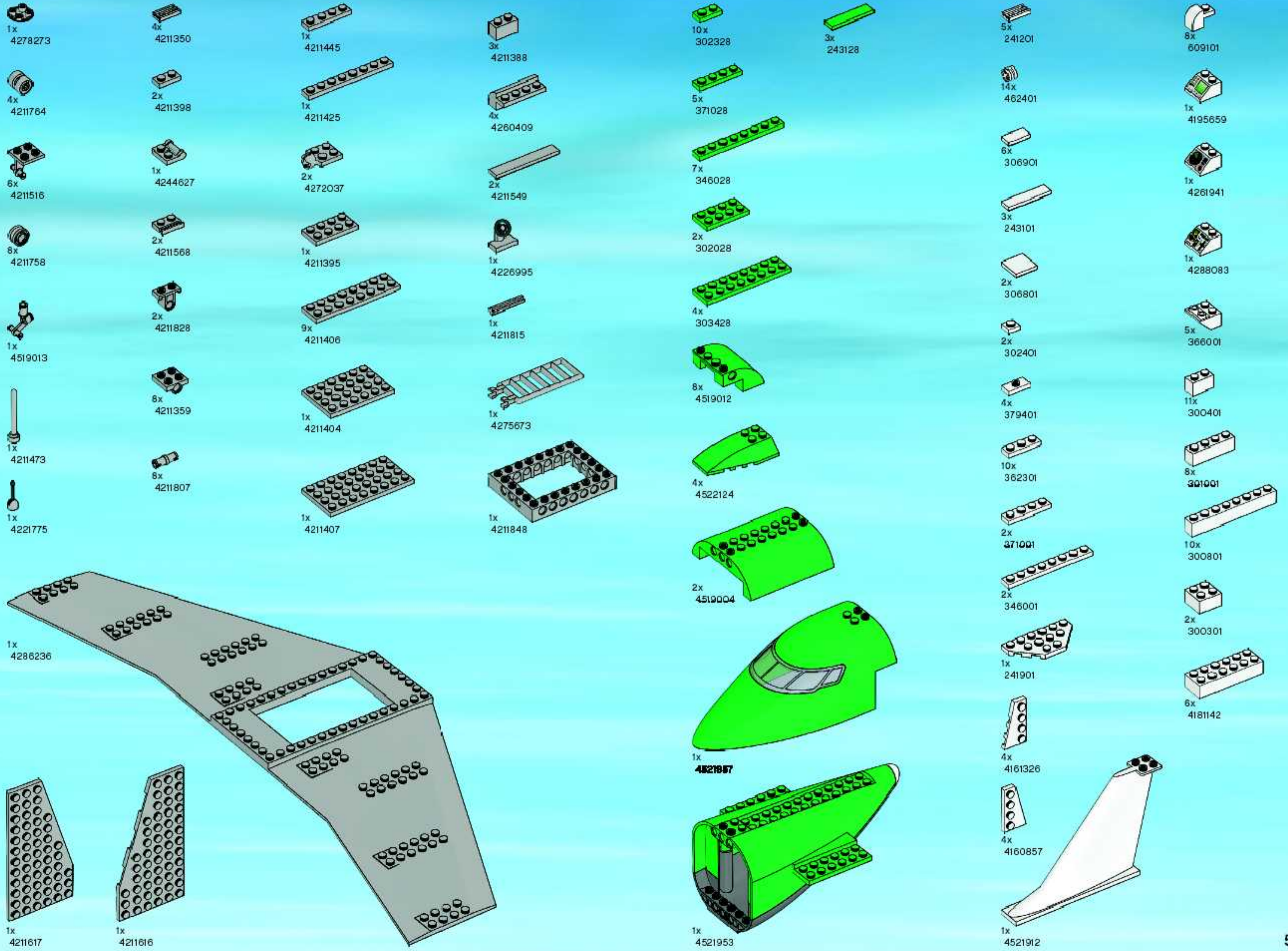



7731



7732



7733



7734



7235



7236



7245



7741



7743



7744



# club™



FREE LEGO Magazine • GRATUIT • GRATIS LEGO Magazin



**Join Today!**

**Abonne-toi  
dès aujourd'hui!**

**Meld je nu aan!**

**Jetzt anmelden!**



US & Canada only

1-866-534-6258 / 1-877-518-5346

(en Français)



00800 5346 5555

[www.LEGOclub.com](http://www.LEGOclub.com)

**VISIT THE WORLD'S  
BIGGEST LEGO® SHOP!**

[www.LEGOshop.com](http://www.LEGOshop.com)

**YES!** I want to join the LEGO® Club FREE!

**OUI !** Je veux m'abonner au Club LEGO® GRATUITEMENT !

**Ja!** Ich möchte Mitglied im kostenlosen LEGO Club werden. **Ja!** Ik wil graag GRATIS lid worden van de LEGO Club.

First Name  
Prénom  
Vorname  
Voornaam

--	--	--	--	--	--	--	--	--	--	--	--	--	--	--	--	--	--	--	--

Last name  
Nom de famille  
Familiename  
Achternaam

--	--	--	--	--	--	--	--	--	--	--	--	--	--	--	--	--	--	--	--

Date of Birth  
Date de naissance  
Geburtsdag  
Geboortedatum

<input type="text"/>	<input type="text"/>	<input type="text"/>	<input type="text"/>	<input type="text"/>	<input type="text"/>
----------------------	----------------------	----------------------	----------------------	----------------------	----------------------

Boy Garçon       Girl Fille   
 Junge Mädchen   
 Jongen Meisje

Street, No.  
Rue  
Straße, Hausnr.  
Straat, huisnr.

--	--	--	--	--	--	--	--	--	--	--	--	--	--	--	--	--	--	--	--

City/County  
Ville  
Stadt  
Woonplaats

<input type="text"/>	State Prov.	<input type="text"/>
----------------------	----------------	----------------------

Zip/Postcode  
Code Postal  
PLZ  
Postcode

<input type="text"/>	Country Pays Land	<input type="text"/>
----------------------	-------------------------	----------------------

Telephone  
No de Téléphone  
Telefonnr.  
Telefoonnummer

--	--	--	--	--	--	--	--	--	--	--	--	--	--	--	--	--	--	--	--

Parent's signature  
Signature d'un parent  
Unterschrift Erziehungsberechtigte/r  
Handtekening ouders

---

**Mail to: / Poster à:** **LEGO Club**  
**P.O. Box 1157**  
**Enfield, CT USA**  
**06083-1157**

**Mail to:**  
**LEGO Club**  
**33 Bath Road**  
**Slough SL1 3UF**  
**United Kingdom**

**Per Post an:**  
**LEGO® Club**  
**Postfach 14 15**  
**D-36243 Niederaula**

**Stuur op naar:**  
**LEGO® Club**  
**Postbus 40252**  
**3504 AB Utrecht**

The English version of the magazine can only be mailed to addresses in the US, Canada, the UK, and Republic of Ireland. Club membership is valid for 2 years and includes free copies of the LEGO Magazine. In the US and Canada please allow up to 6 weeks for delivery of your first magazine. By signing this form you consent the LEGO Club to use your child's data for LEGO mailings. The data will only be used for LEGO mailings and will not be sold, rented or otherwise disclosed to any company outside the LEGO Company except for disclosure to companies acting as our agents to help us provide services requested by the child. This coupon good for one free membership per person, group or organization (photocopies not accepted).

La version française du magazine peut être postée uniquement au Canada. L'abonnement est valide pour 2 ans et inclut des exemplaires gratuits du Magazine LEGO. Aux É.-U. et au Canada, allouer 6 semaines pour la livraison initiale. En remplissant ce formulaire, vous consentez à ce que LEGO utilise les informations de votre enfant pour des envois postaux de LEGO. L'information sera utilisée uniquement pour des envois postaux par LEGO et ne sera en aucun cas, vendue, louée, échangée ou divulguée à d'autres compagnies autres que la compagnie LEGO, à l'exception des compagnies affiliées qui nous procurent des services auxquels l'enfant en a fait la demande.

Das deutschsprachige Angebot gilt nur für die Länder D, AU und CH. Die kostenlose Mitgliedschaft beinhaltet die Zusendung des LEGO Magazins und endet nach zwei Jahren. Für die Mitglieder entstehen keine Verpflichtungen. Es kann bis zu drei Monate dauern, bis das erste Magazin zugestellt wird. Mit Ihrer Unterschrift erklären Sie sich einverstanden, dass die Daten Ihres Kindes zum Zweck einer LEGO Club-Mitgliedschaft von der LEGO Gruppe gespeichert werden. Die Daten werden vertraulich behandelt und nicht an Dritte weitergegeben, außer an Dienstleister des LEGO Clubs. Wenn Sie außer vom LEGO Club keine weiteren Informationen von der LEGO Company bekommen möchten bitte hier ankreuzen:

Door dit formulier te tekenen geeft u de LEGO Club toestemming om bovenstaande gegevens te gebruiken voor het toesturen van LEGO mailings. Uw gegevens worden uitsluitend gebruikt voor mailings van LEGO en zullen niet worden verkocht, verhuurd of op welke wijze dan ook verstrekt aan derden buiten de LEGO Groep, uitgezonderd de organisaties die namens ons optreden om de service te verlenen waar uw kind om gevraagd heeft.

[www.acnielsen.aim.dk/LEGO](http://www.acnielsen.aim.dk/LEGO)



## WIN LEGO® PRODUCTS

No purchase necessary.

Open to residents of all countries where not prohibited.

Go to [www.lego.com](http://www.lego.com) for official rules and details.

## WIN LEGO® PRODUCTEN

Kopen niet nodig.

Open voor alle leeftijden, en in alle landen waar geen verbod geldt.

Ga naar [www.lego.com](http://www.lego.com) voor officiële regels en details.

## GEWINNE LEGO® PRODUKTE

Die Teilnahme am Gewinnspiel führt zu keinerlei Kaufverpflichtungen.

Sie können in allen nicht ausgeschlossenen Ländern teilnehmen.

Die offiziellen Regeln und nähere Informationen finden Sie unter [www.lego.com](http://www.lego.com).

## GAGNE DES PRODUITS LEGO®

Aucun achat n'est nécessaire.

Ouvert à tous les âges et aux résidents de tous les pays, sauf en cas d'interdiction.

Rendez-vous sur [www.lego.com](http://www.lego.com) pour obtenir plus de détails et le règlement officiel.

## レゴ®製品を「当てよう」

購入は不要です

禁止されていない限り、あらゆる年代およびあらゆる国の居住者の方々にご利用いただけます。

公認規則および詳細につきましては、

[www.lego.com](http://www.lego.com) をご覧ください



©2008 The LEGO Group. 4525921