



Harry Potter



4766



WARNING: CHOKING HAZARD.
Small parts. Not for children under 3 years.

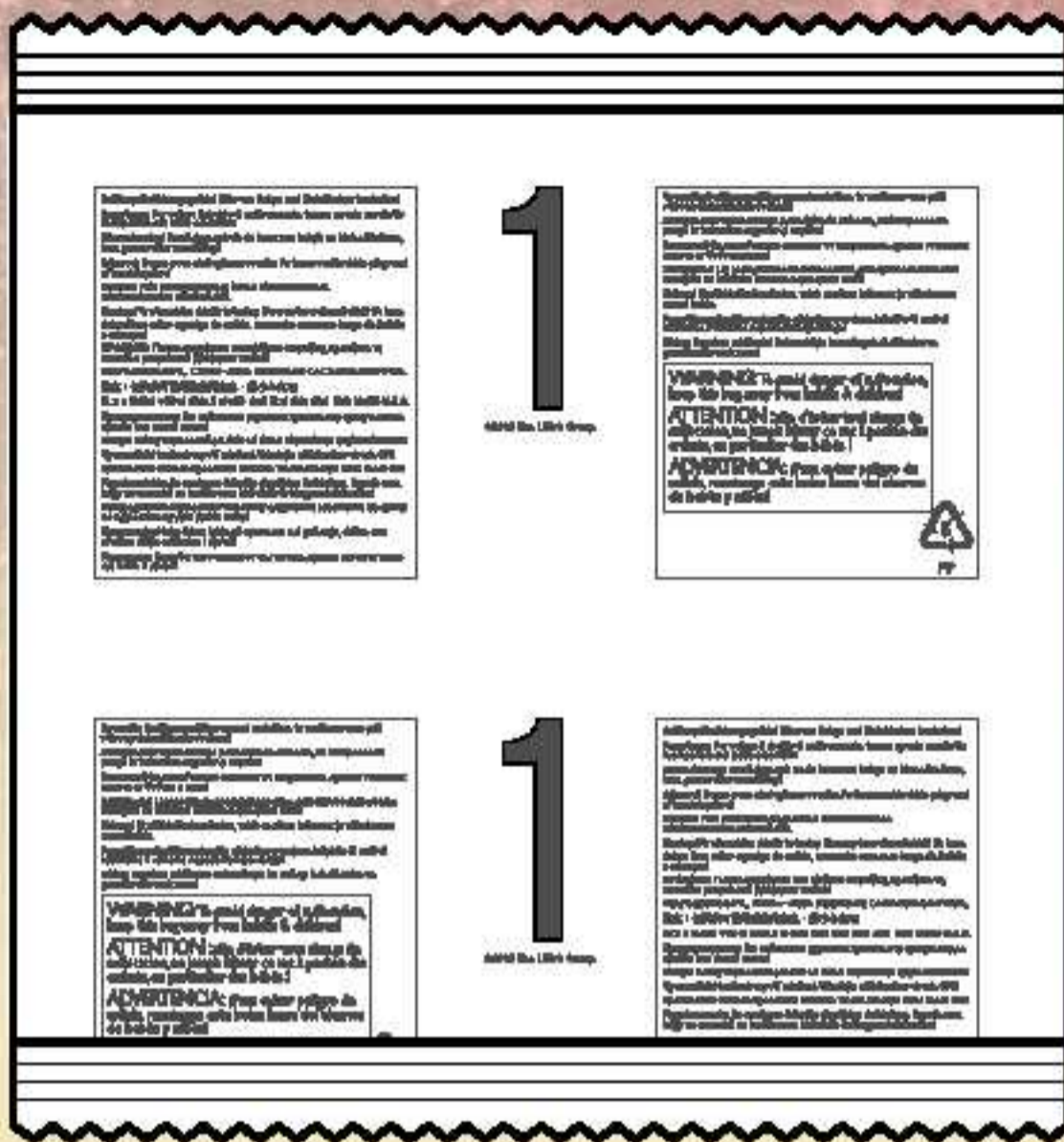

AVERTISSEMENT : RISQUE D'ÉTOUFFEMENT.
 Contient des petites pièces. Ne convient pas aux enfants de moins de 3 ans.



ADVERTENCIA: PELIGRO DE ASFIXIA.
 No recomendado para niños menores de 3 años. Contiene piezas pequeñas.

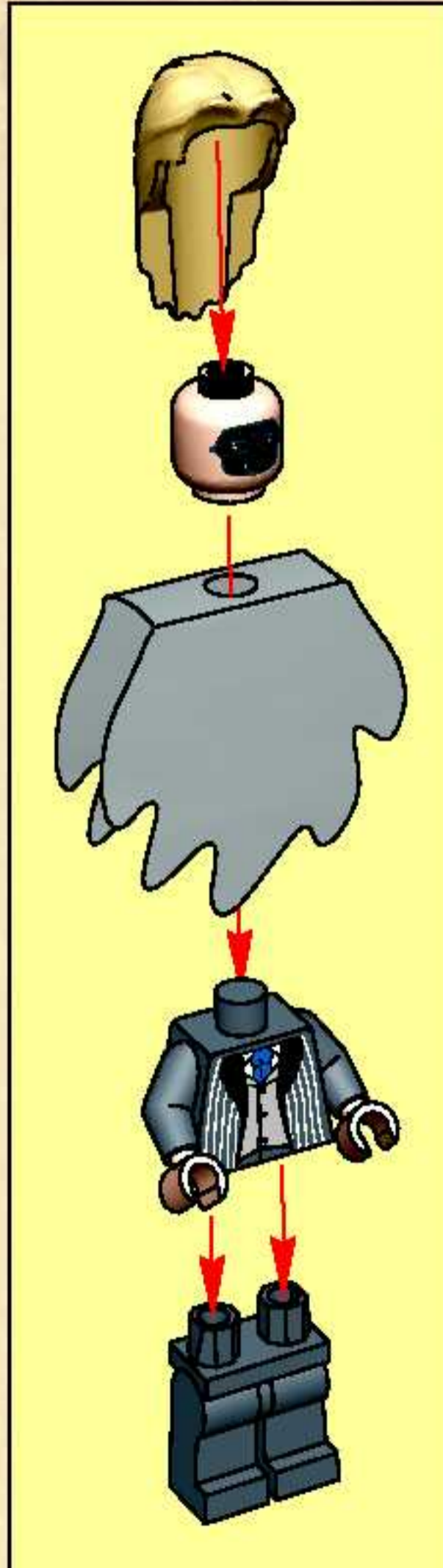



1



2

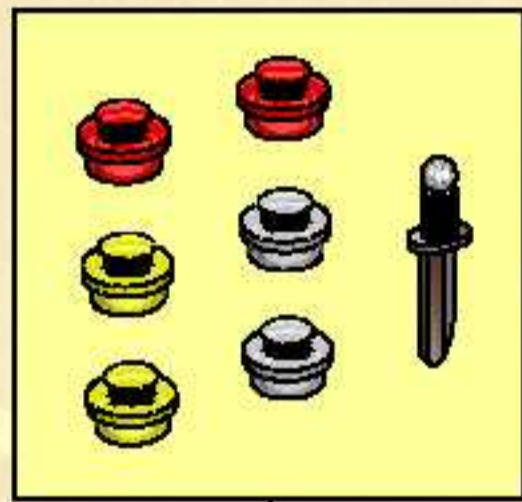

3



1



2

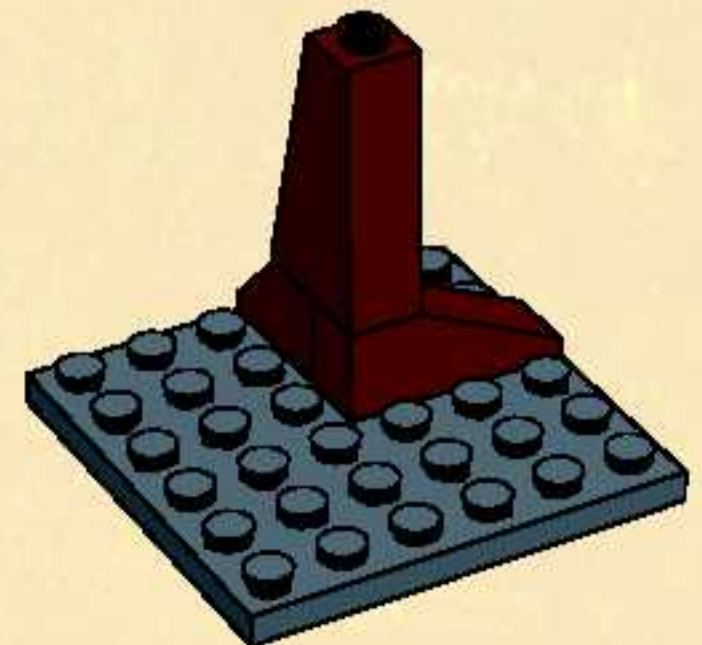

3

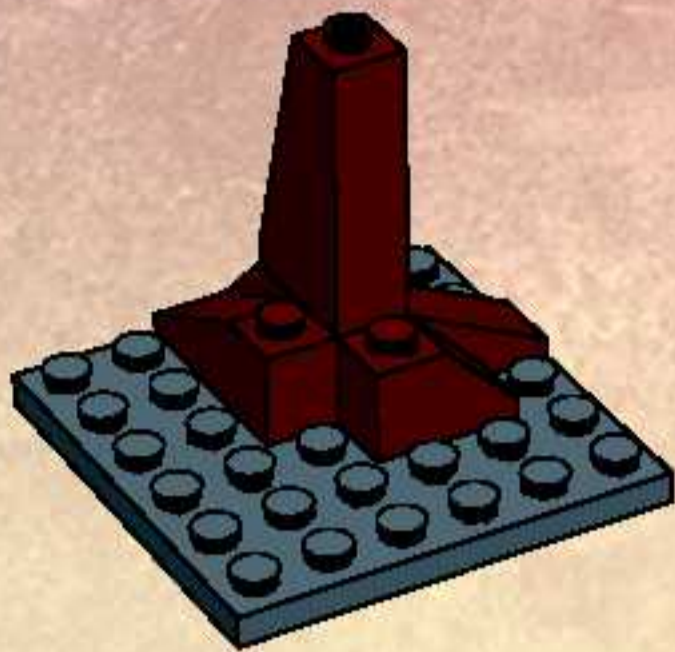

4

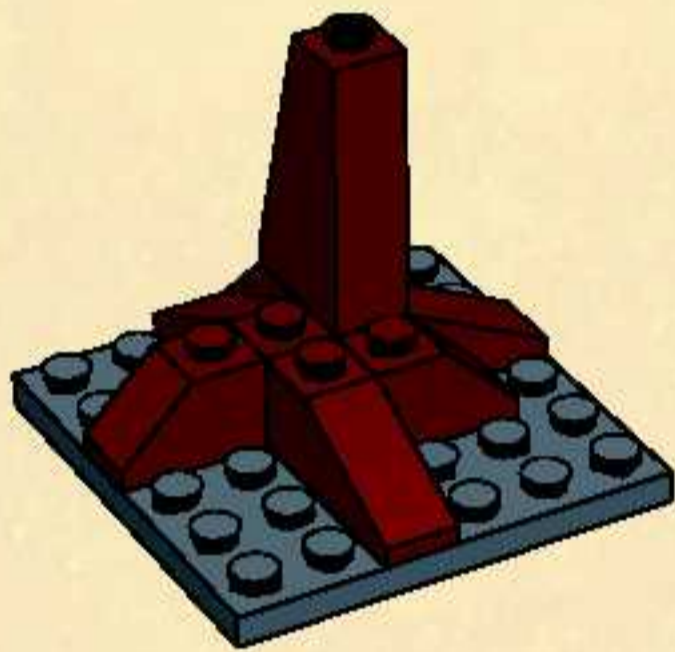

5

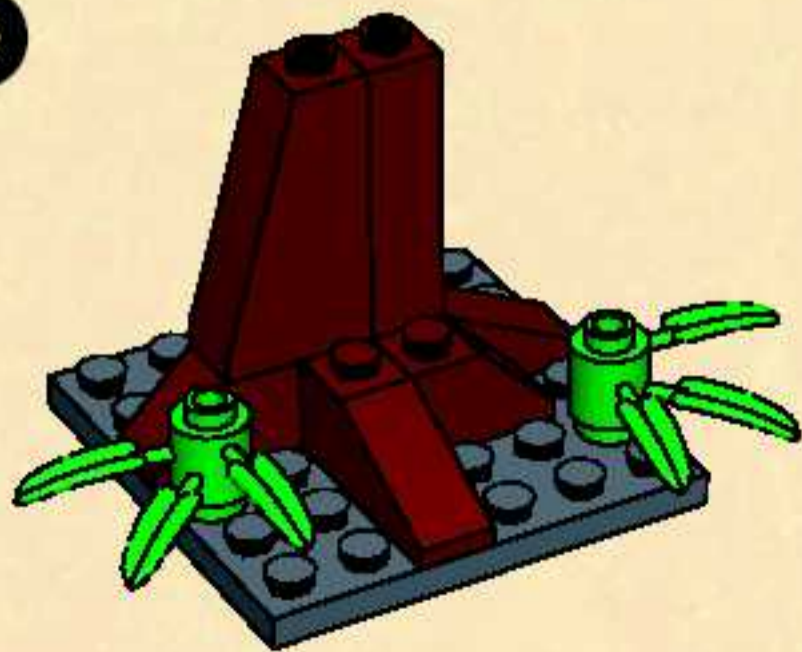

6

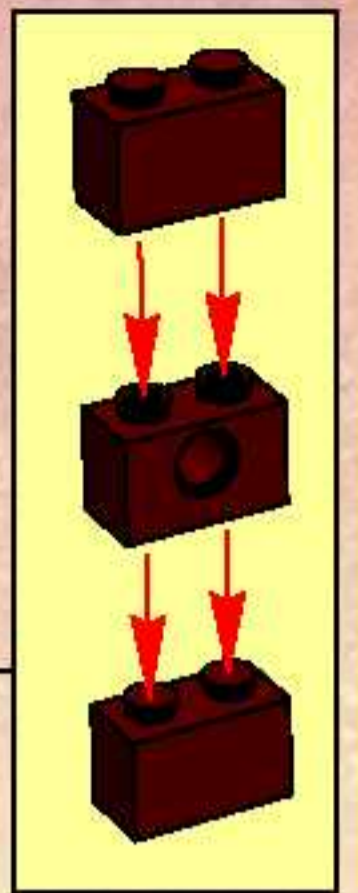
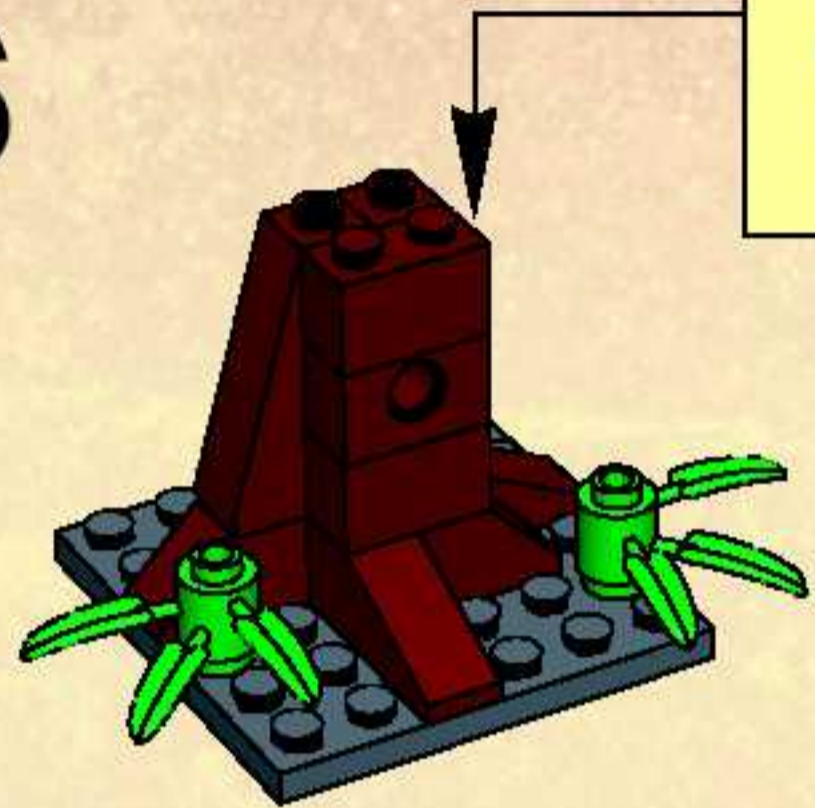

7

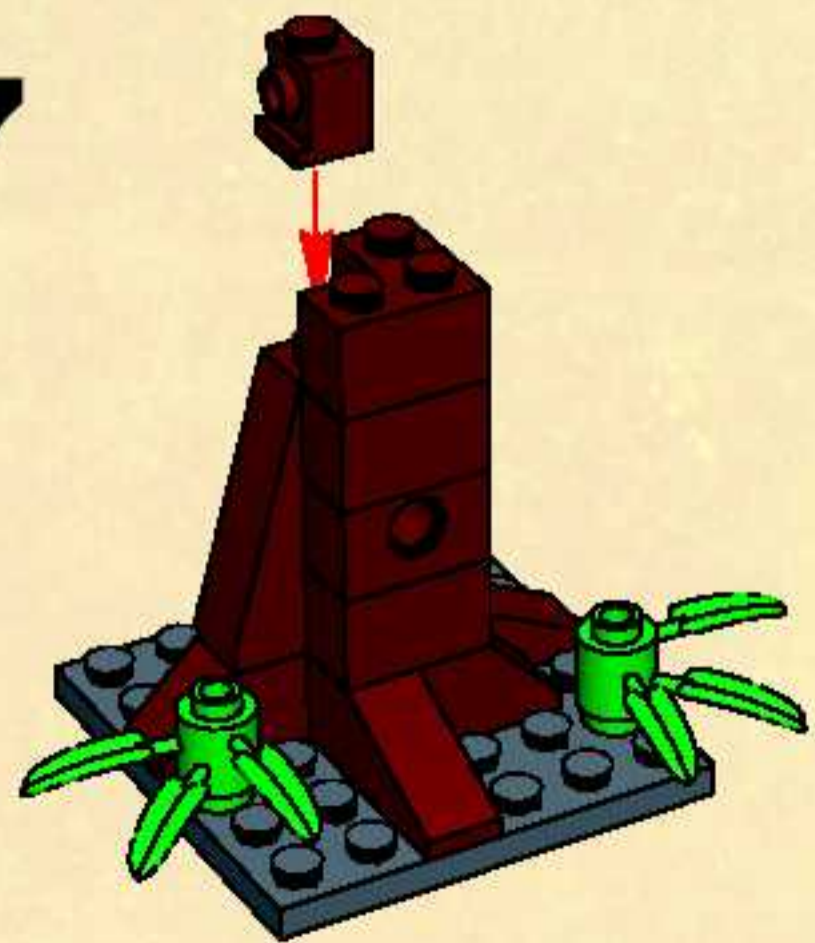

8

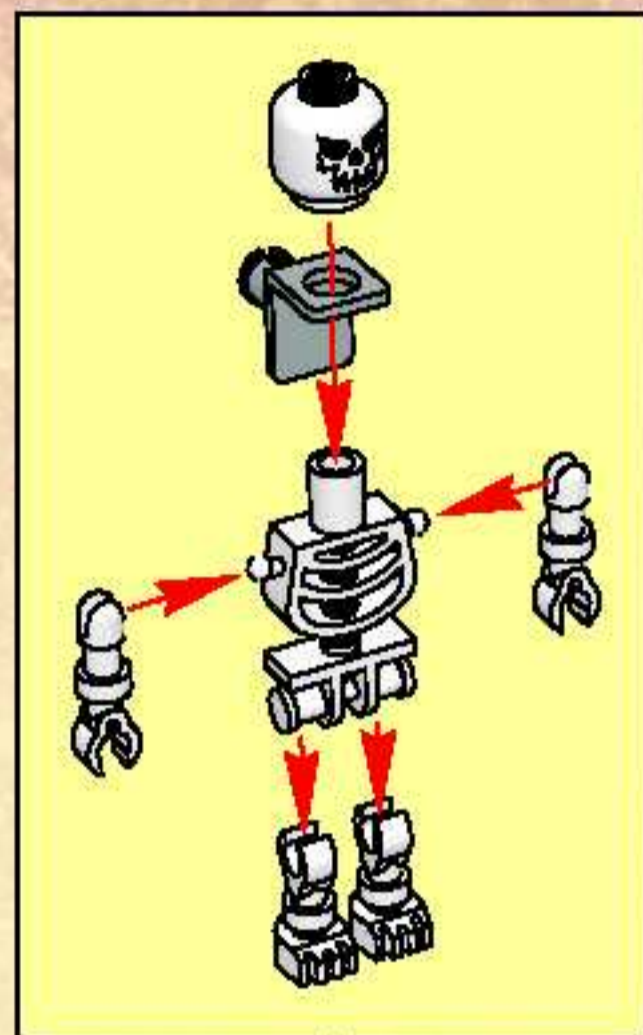
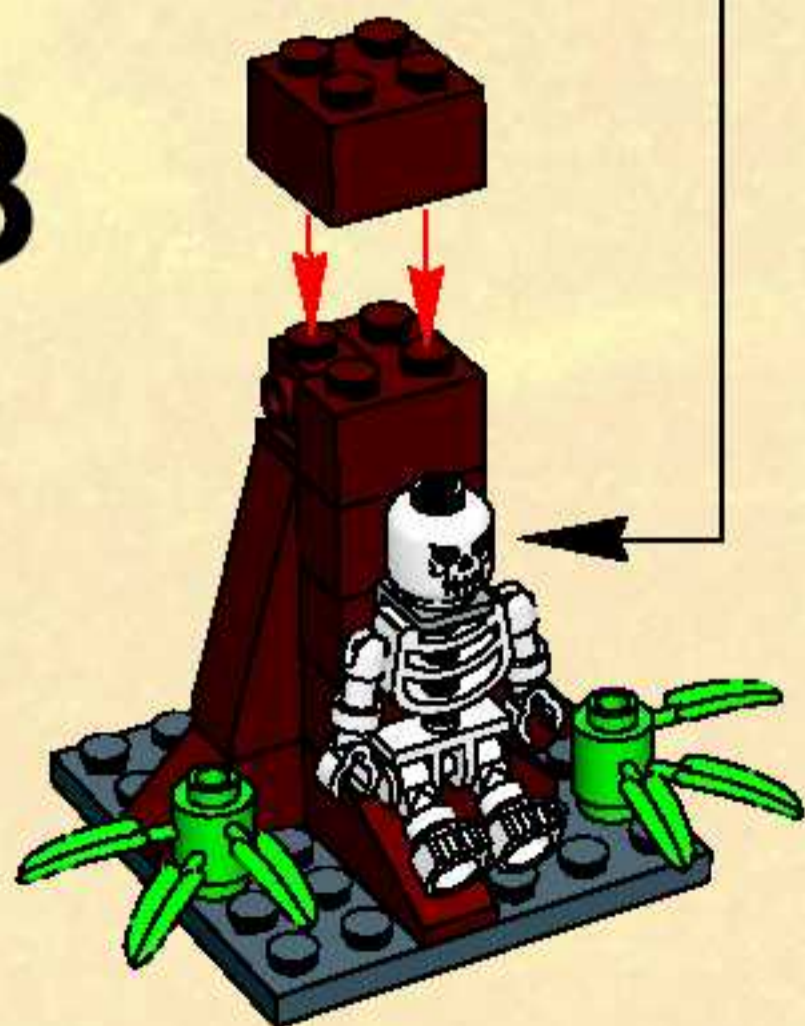

9

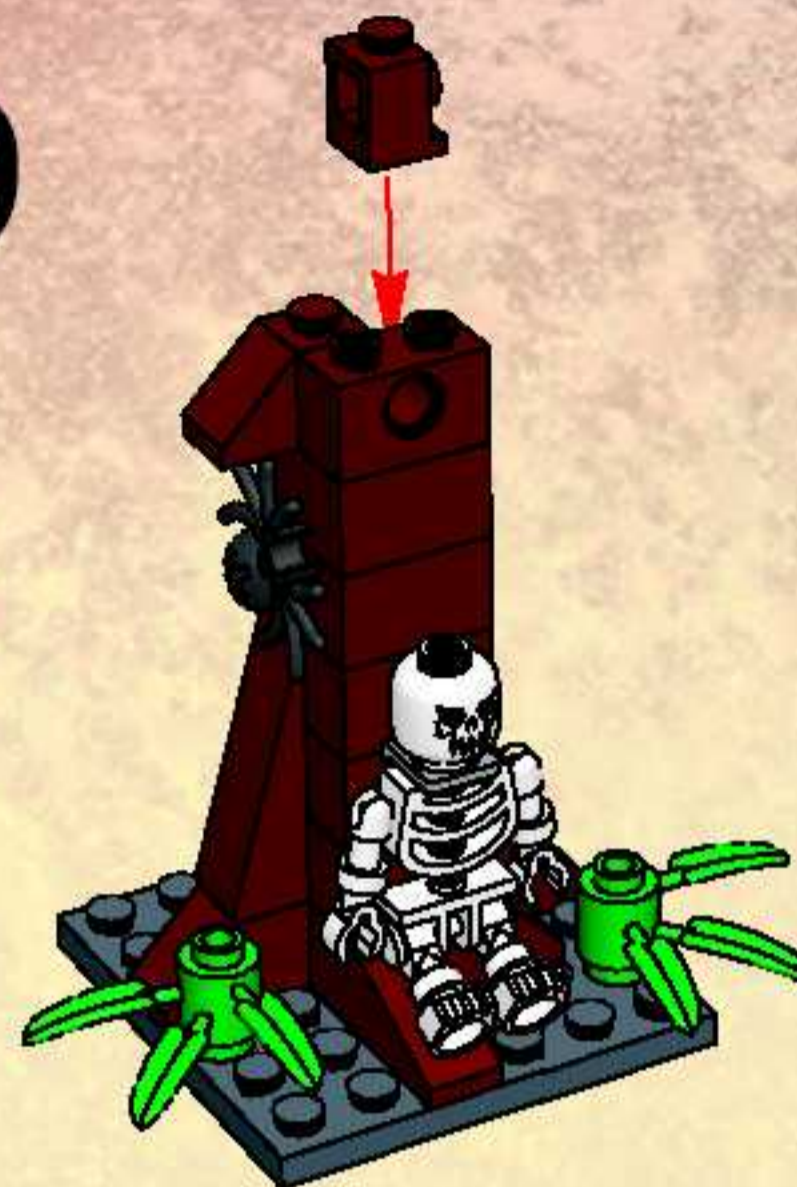

10



11



12

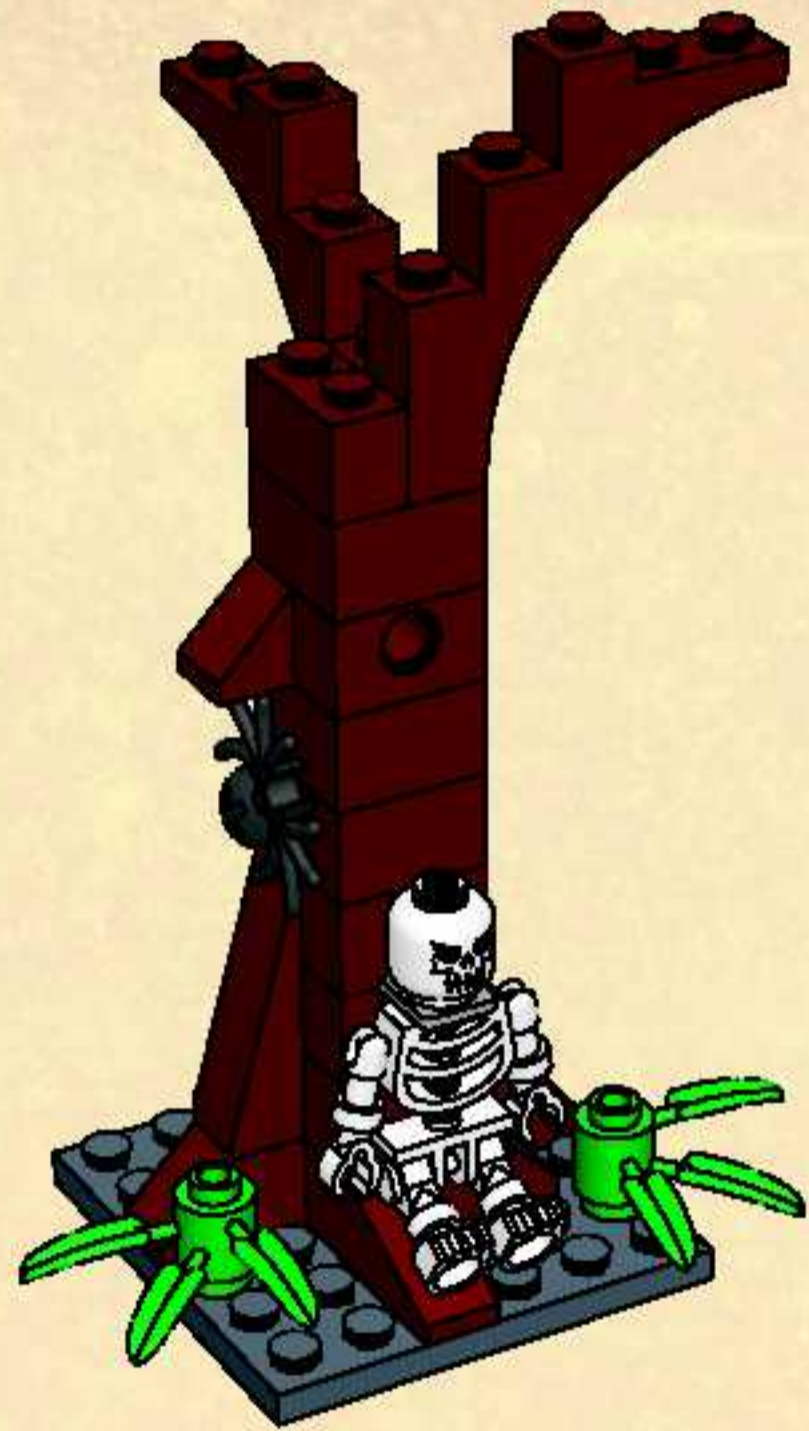

13



14

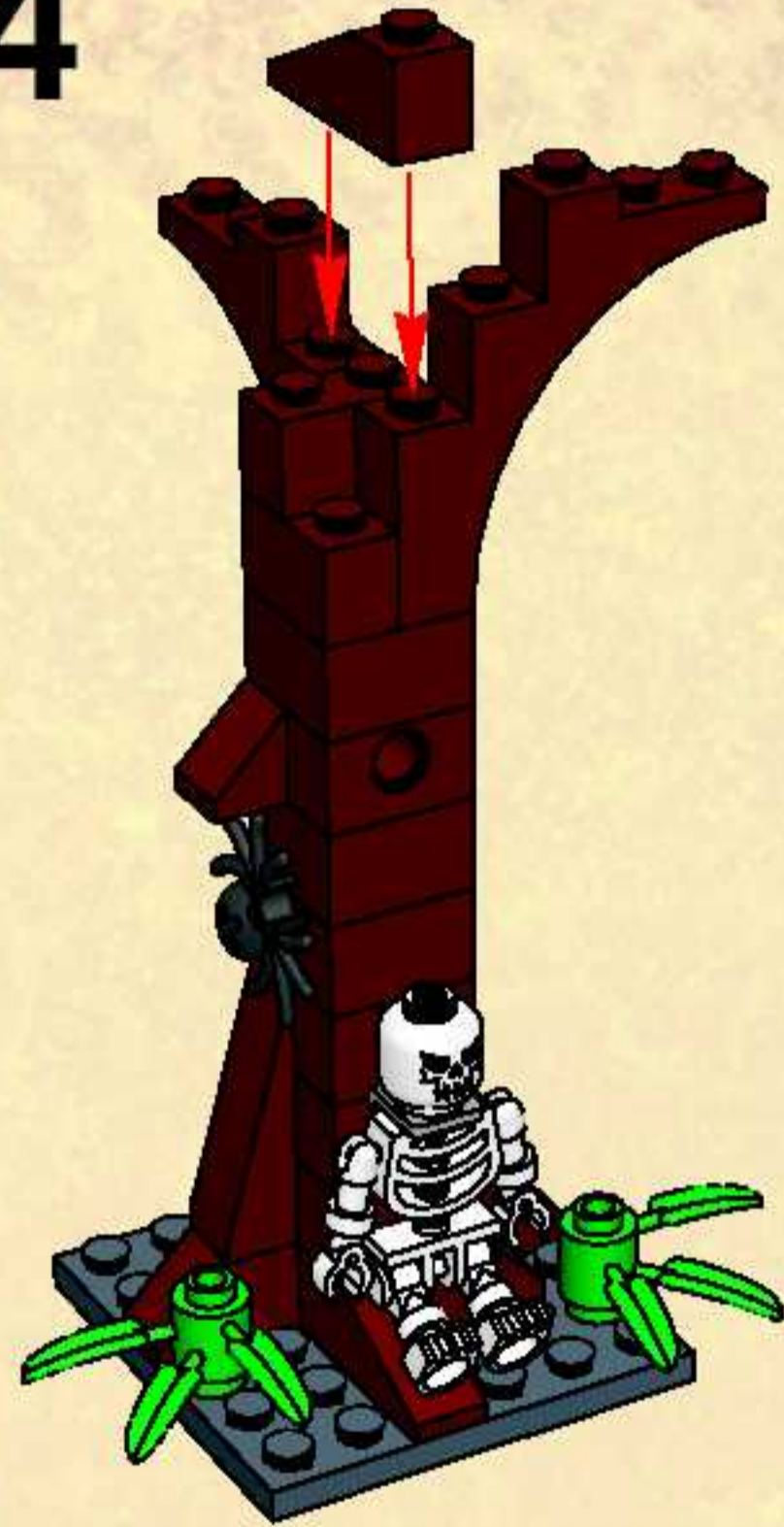

15



16



17

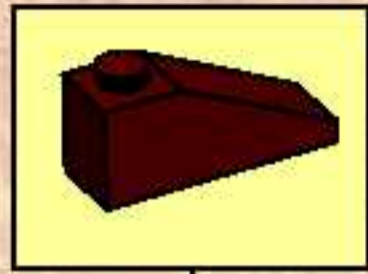

18



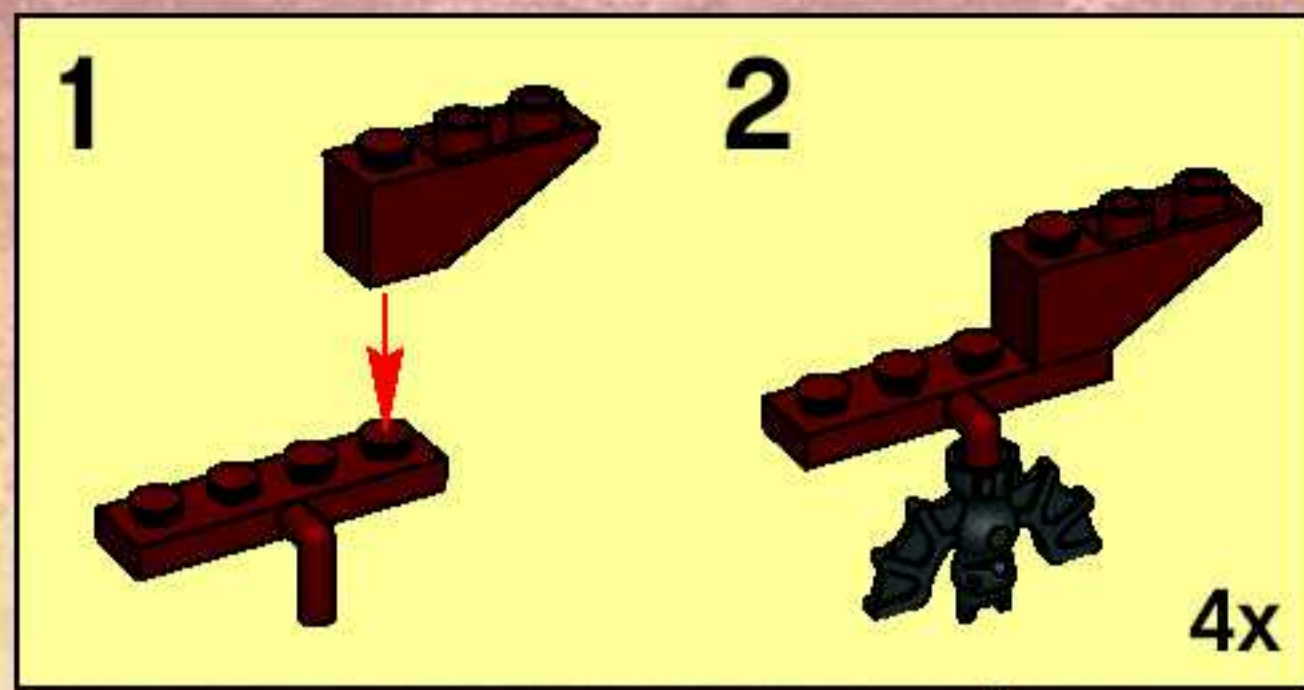

19

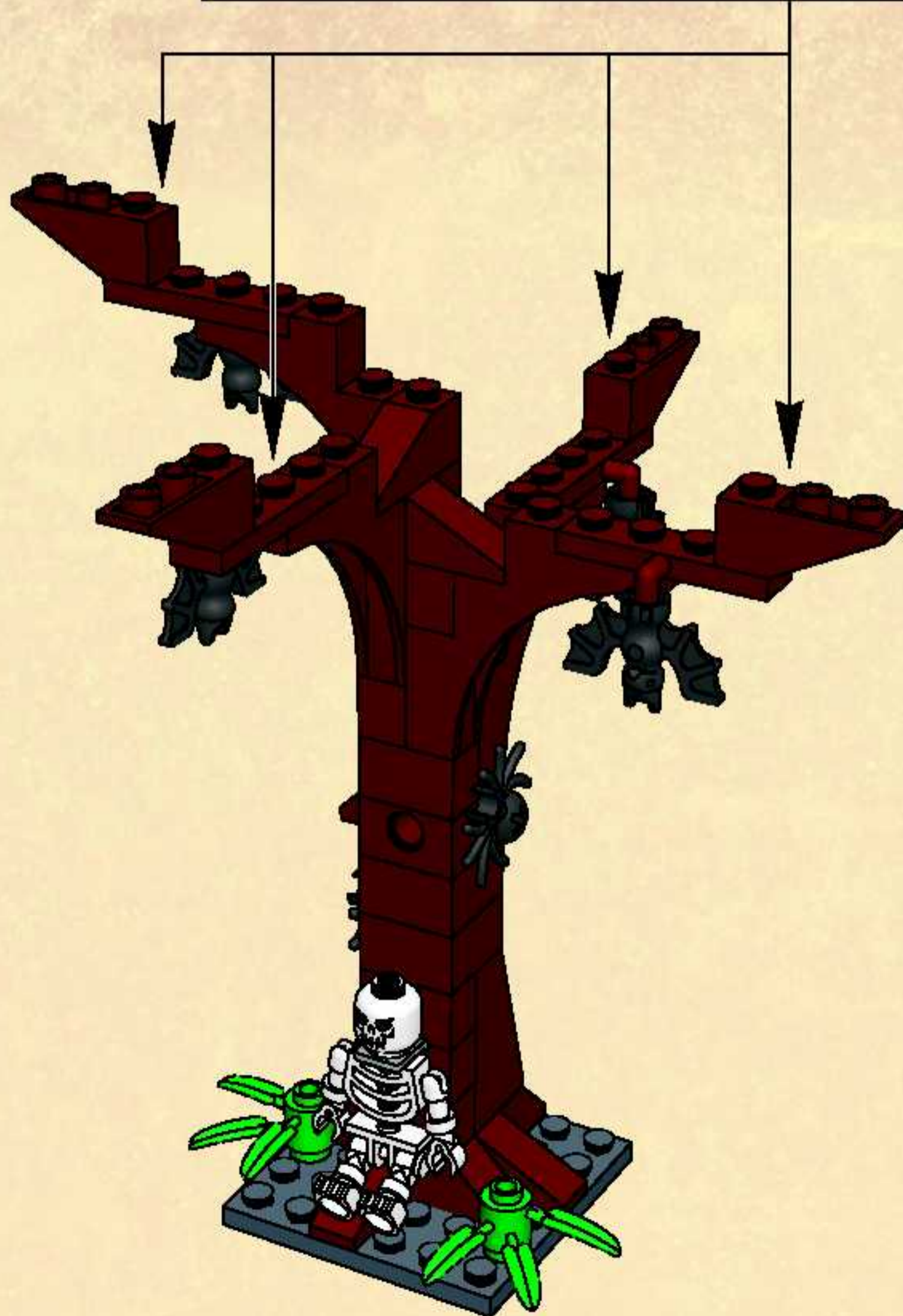

20



2
 ATTN: No. 1284 Group.

2
 ATTN: No. 1284 Group.

ATTENTION: Pour éviter d'endommager les pièces, ne les appuyez pas trop fort.

ATTENTION: Para evitar dañar las piezas, no las apriete demasiado fuerte.

ATTENTION: To avoid damaging the parts, do not press too hard on them.

ATTENTION: Para evitar dañar las piezas, no las apriete demasiado fuerte.

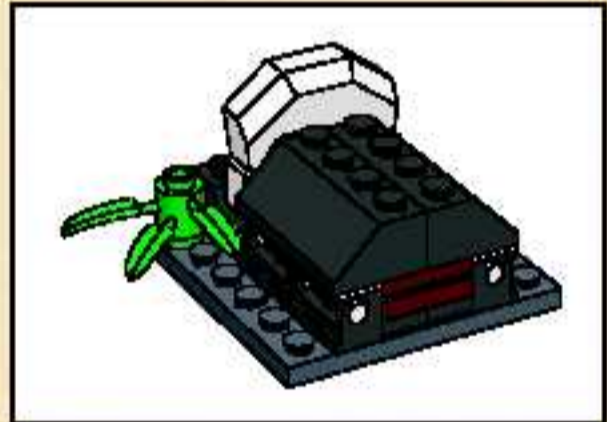

1

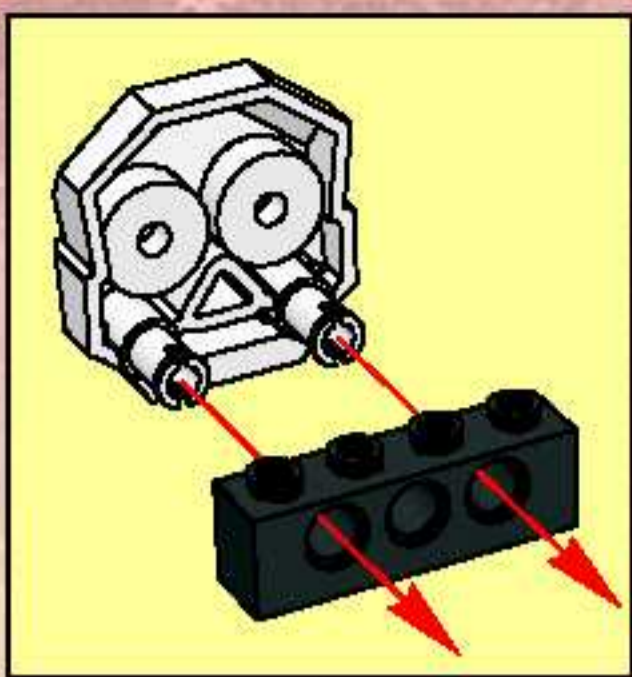

2

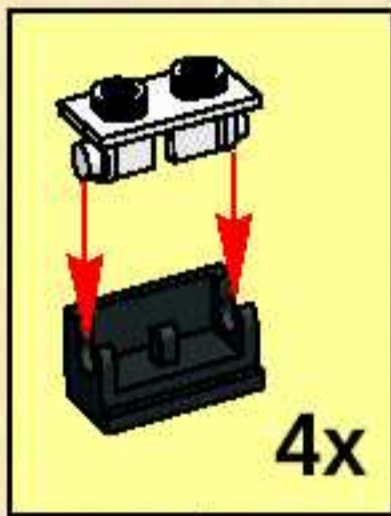
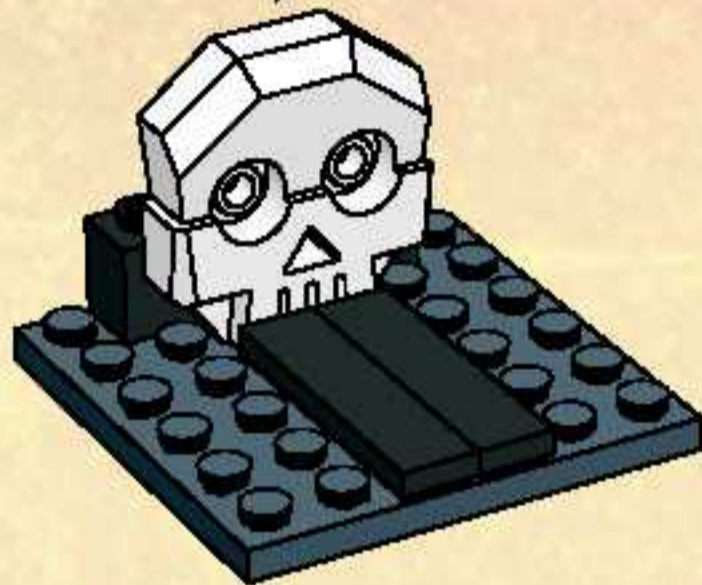

3

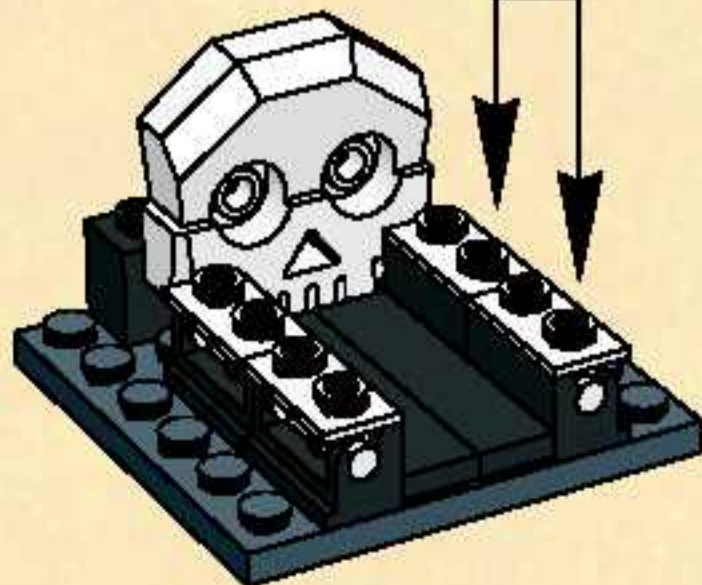

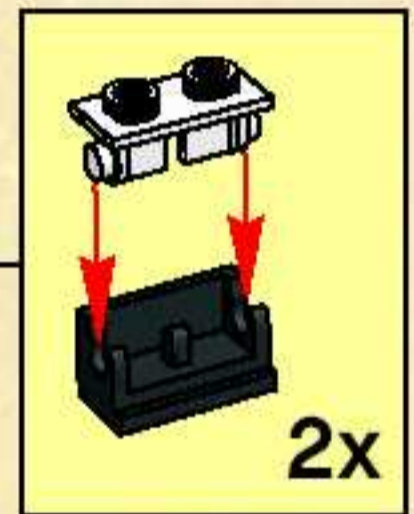
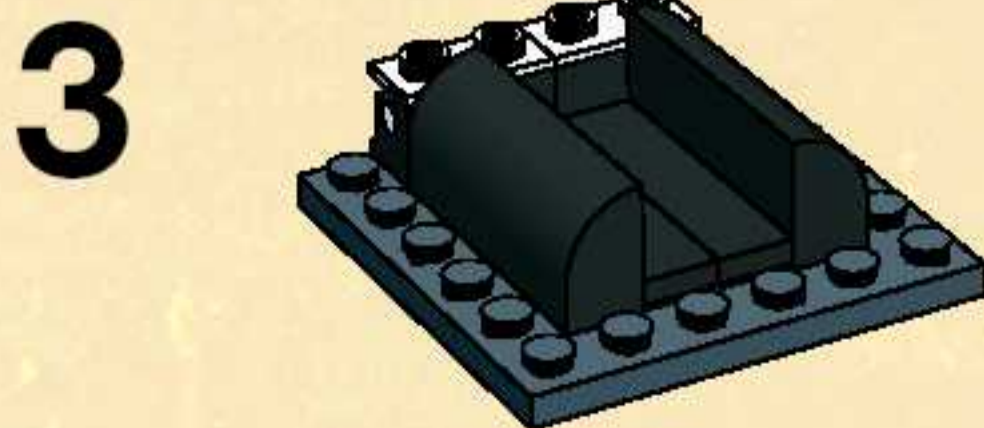
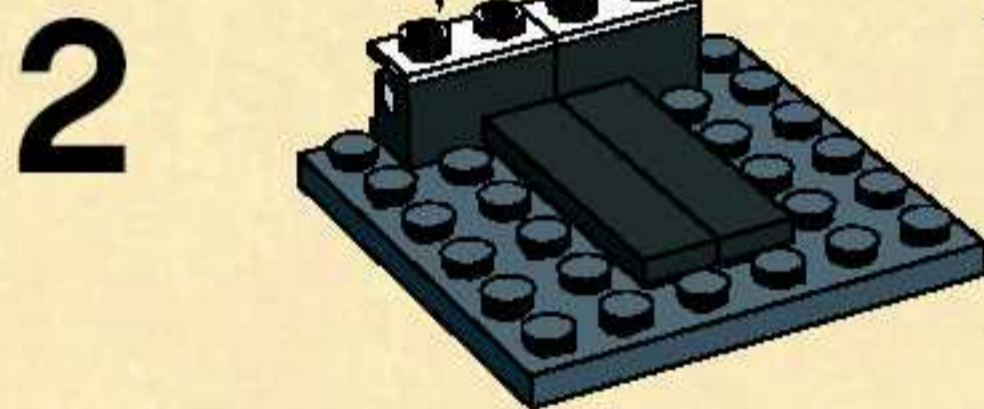
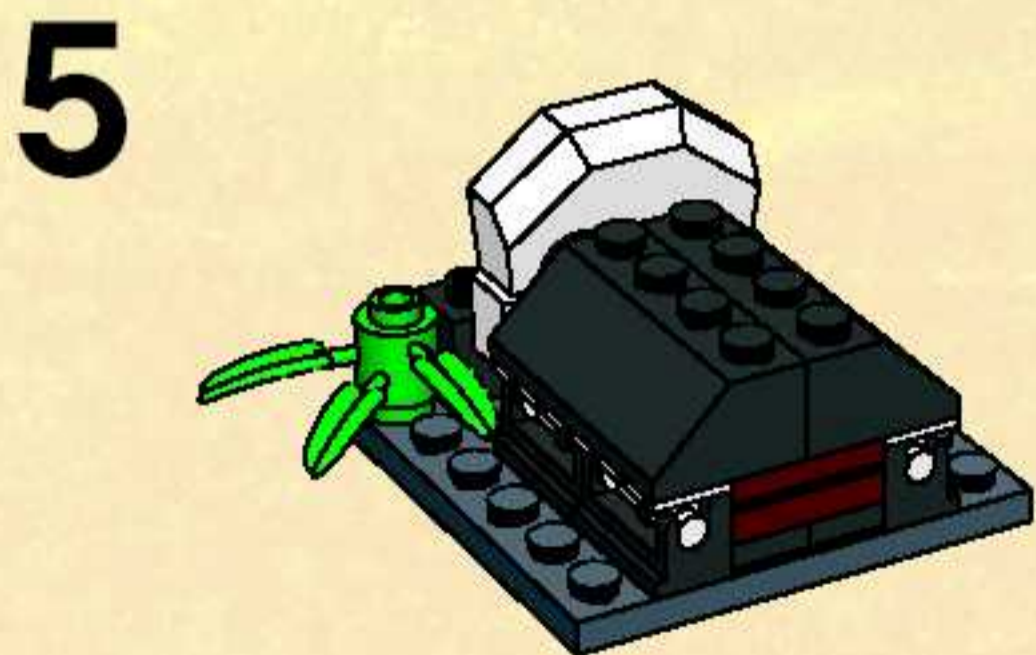
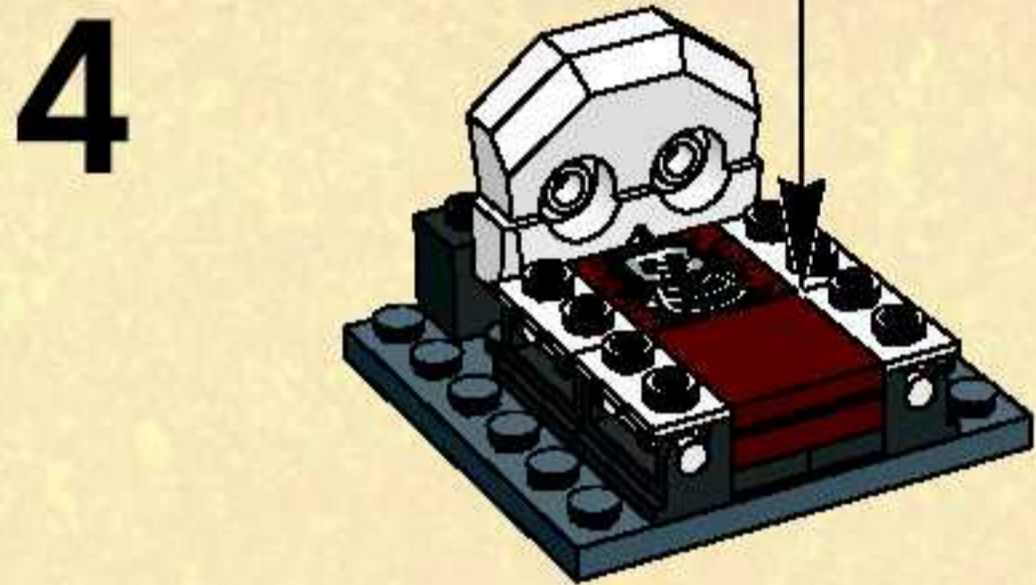
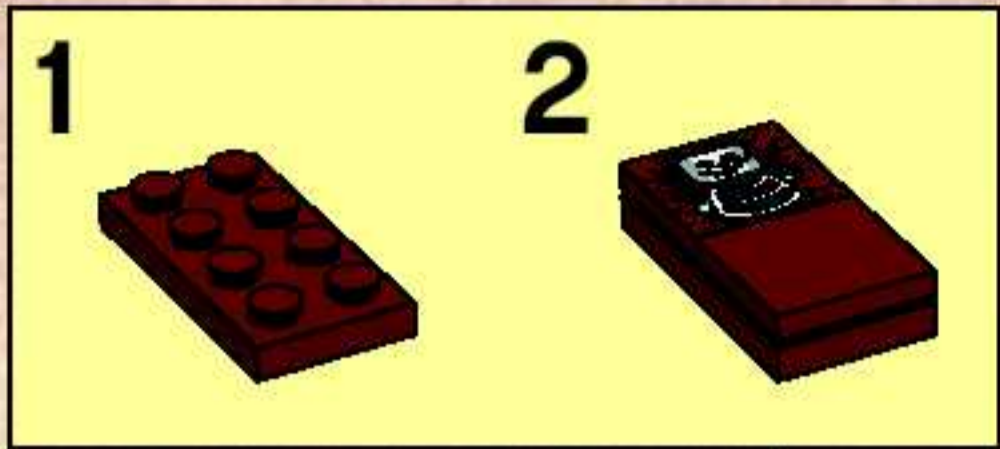

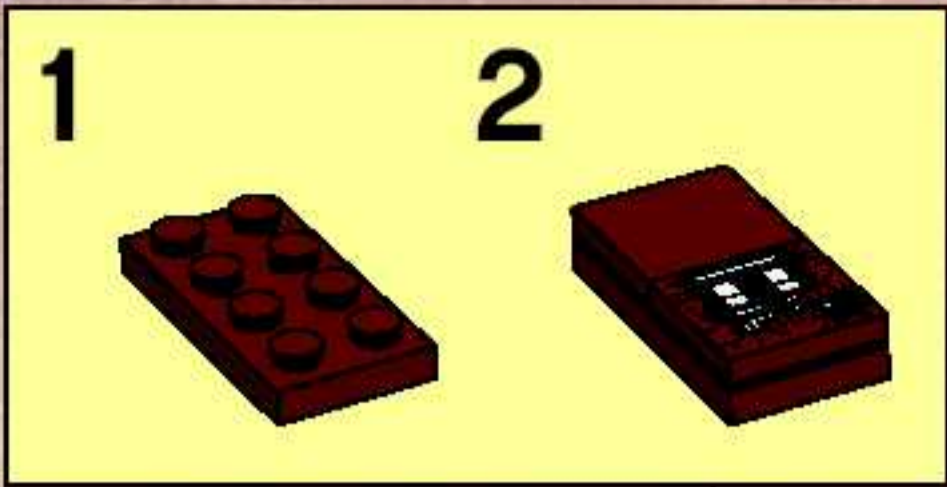

4

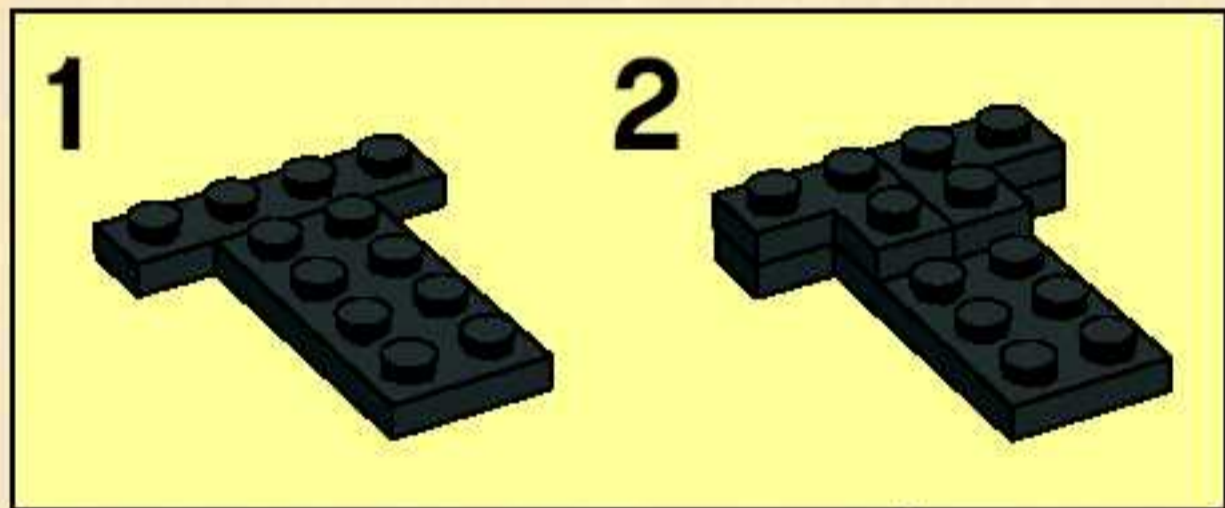

5

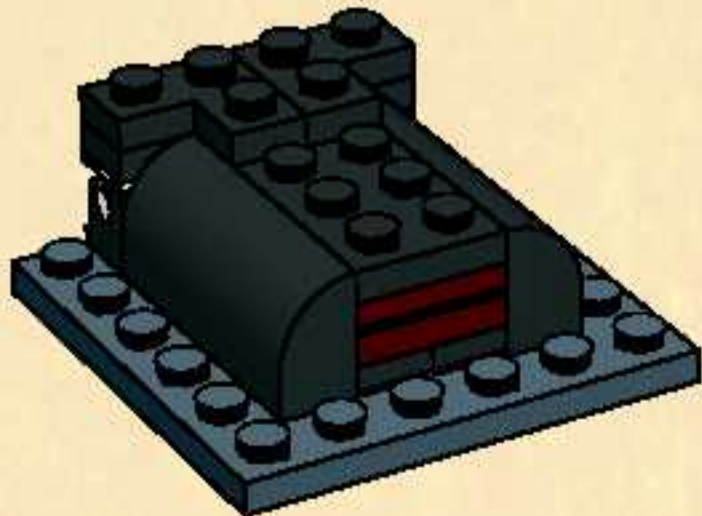

6

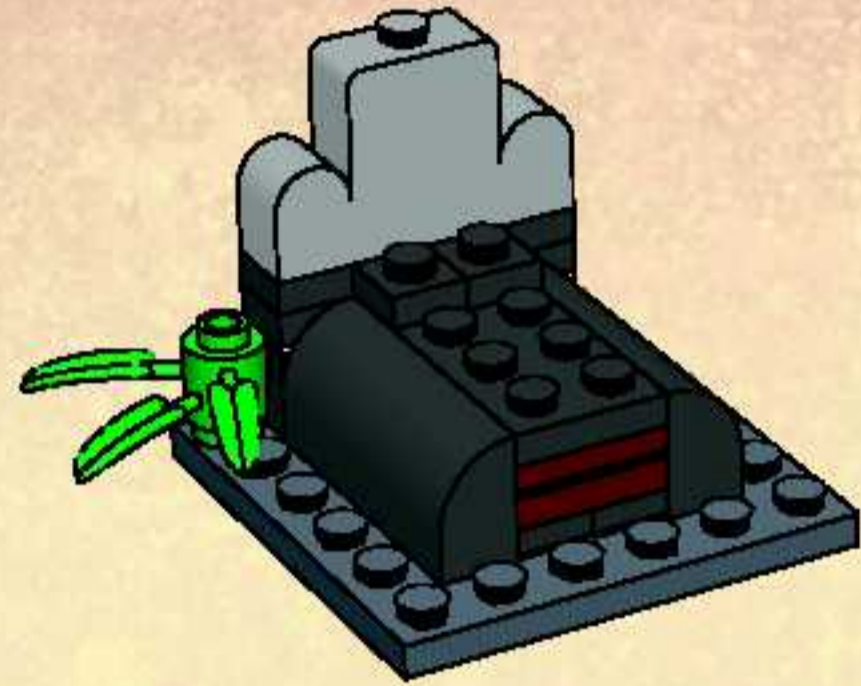

7

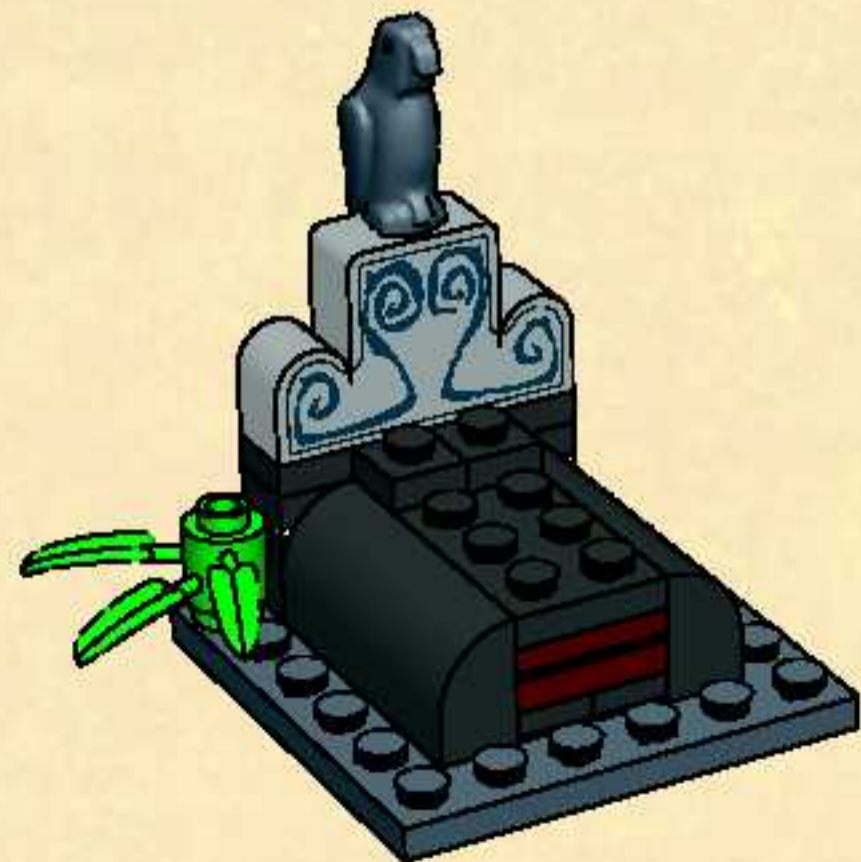

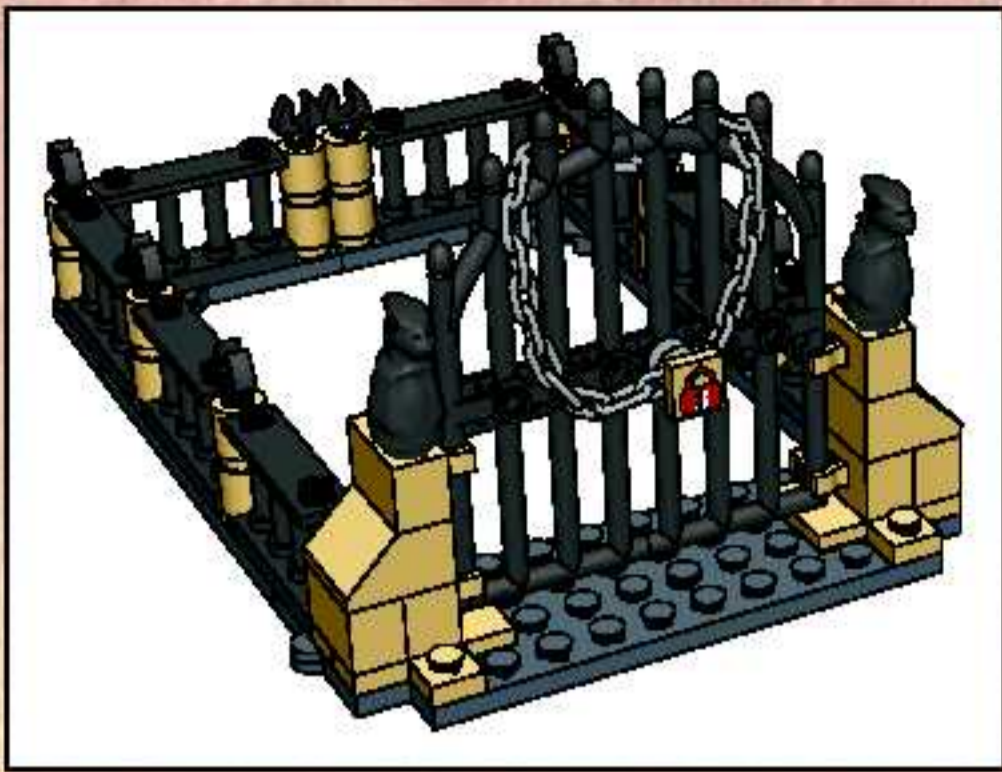

1

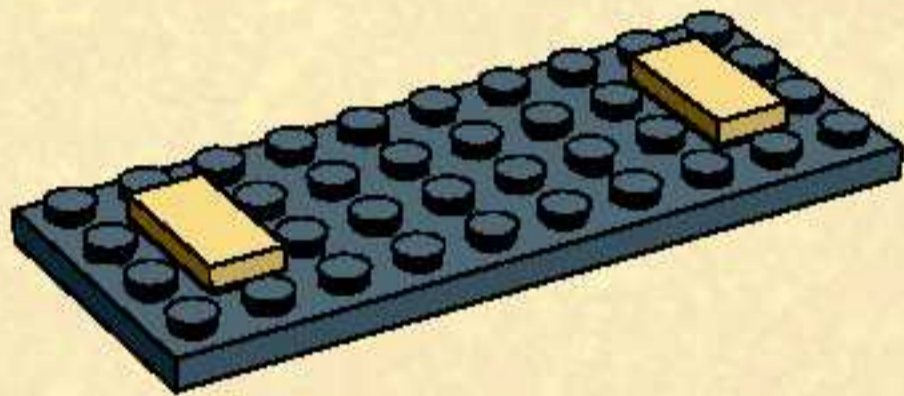

2

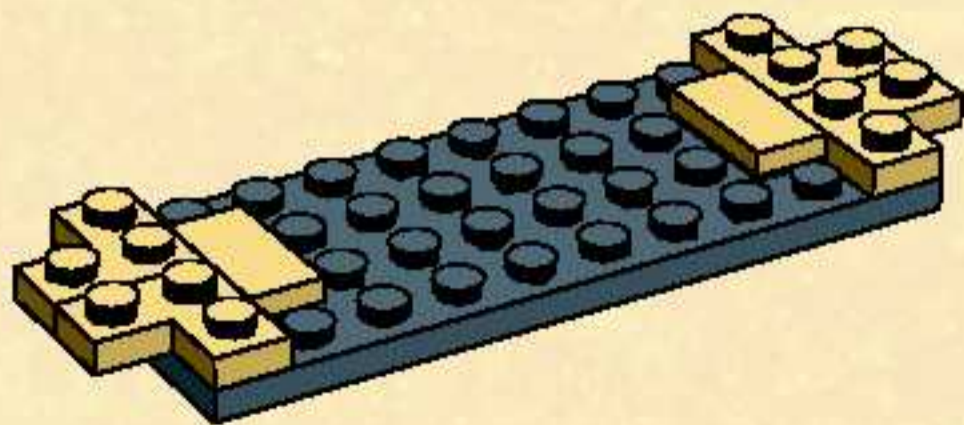

3

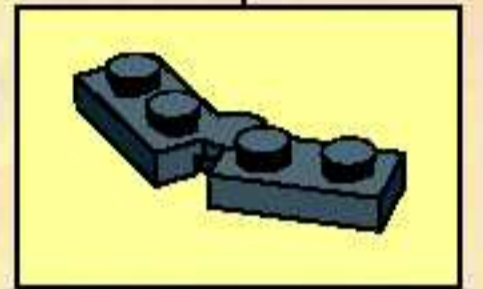
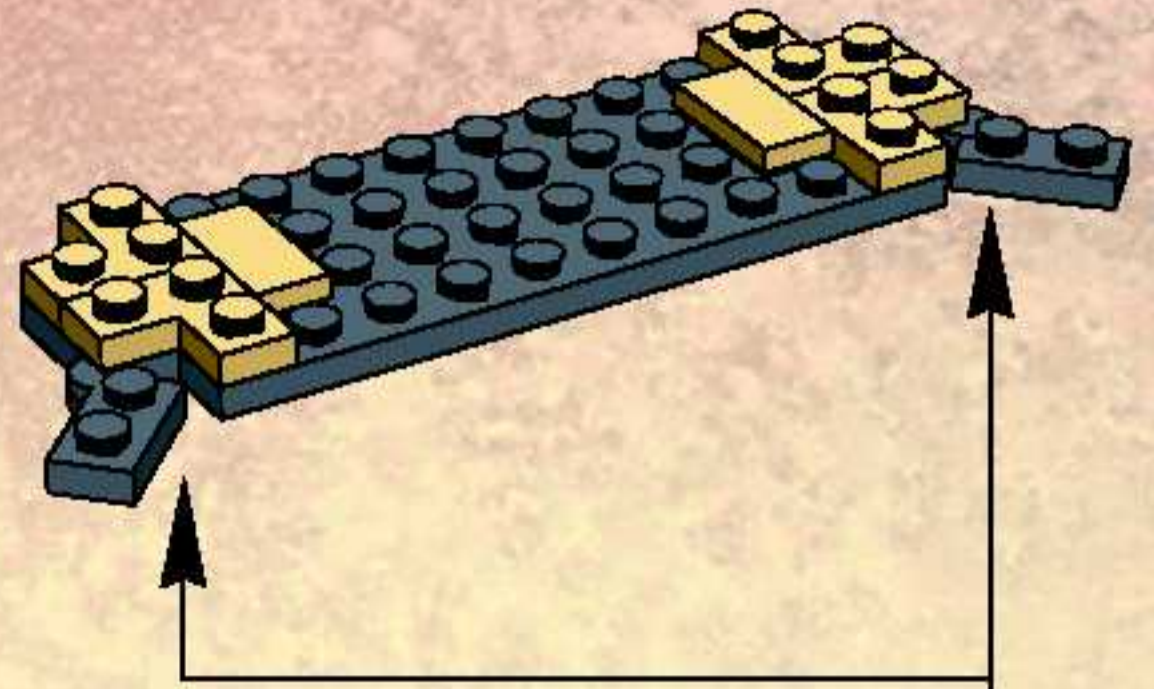

4

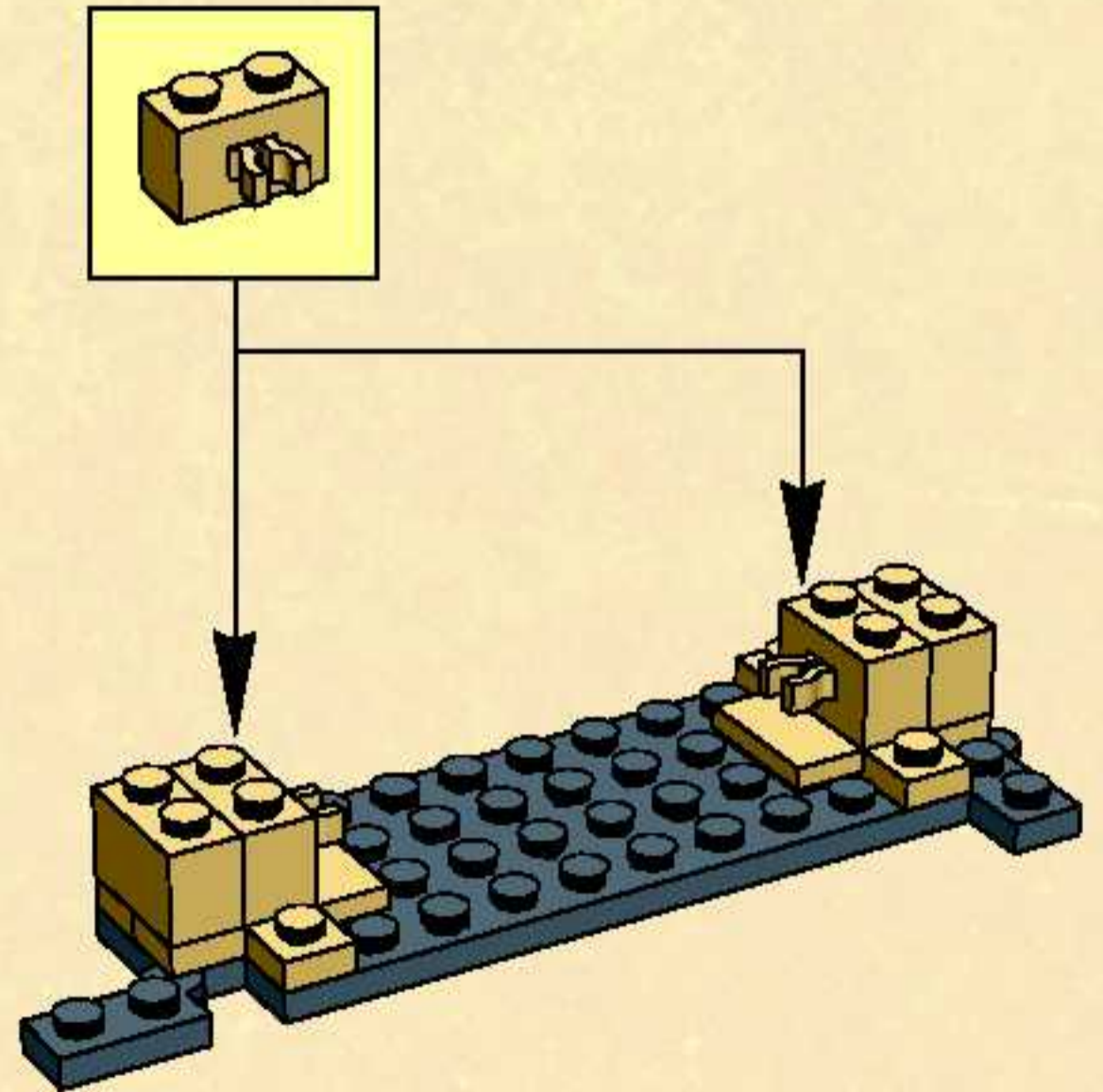

5

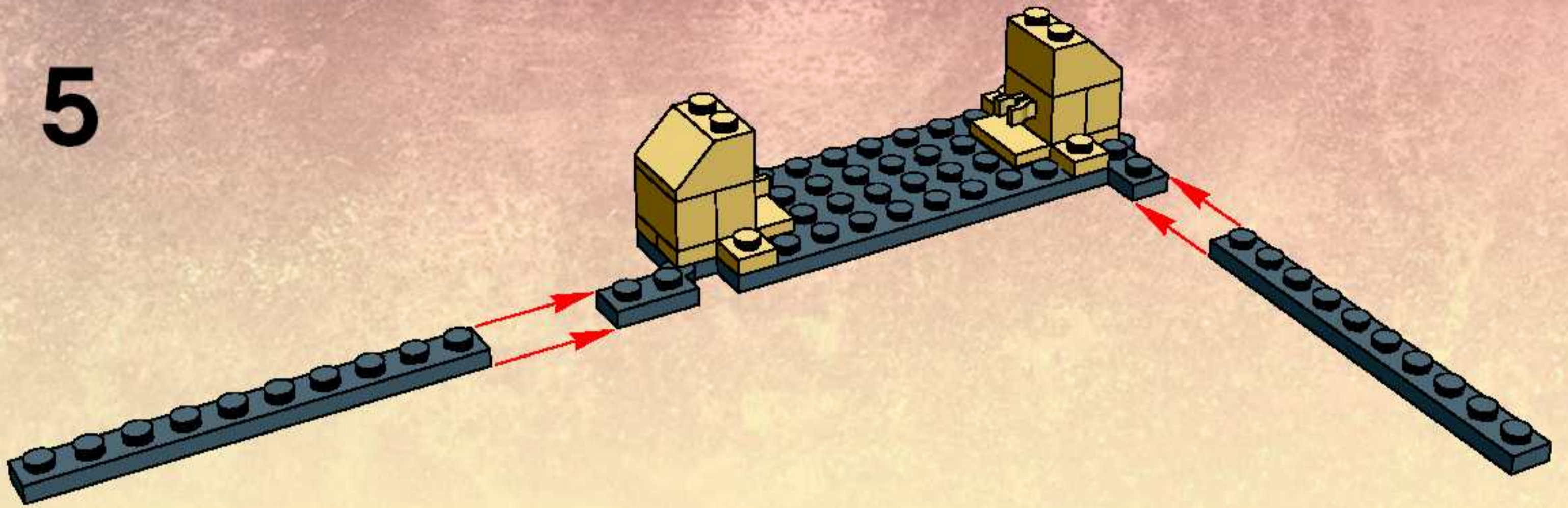

6

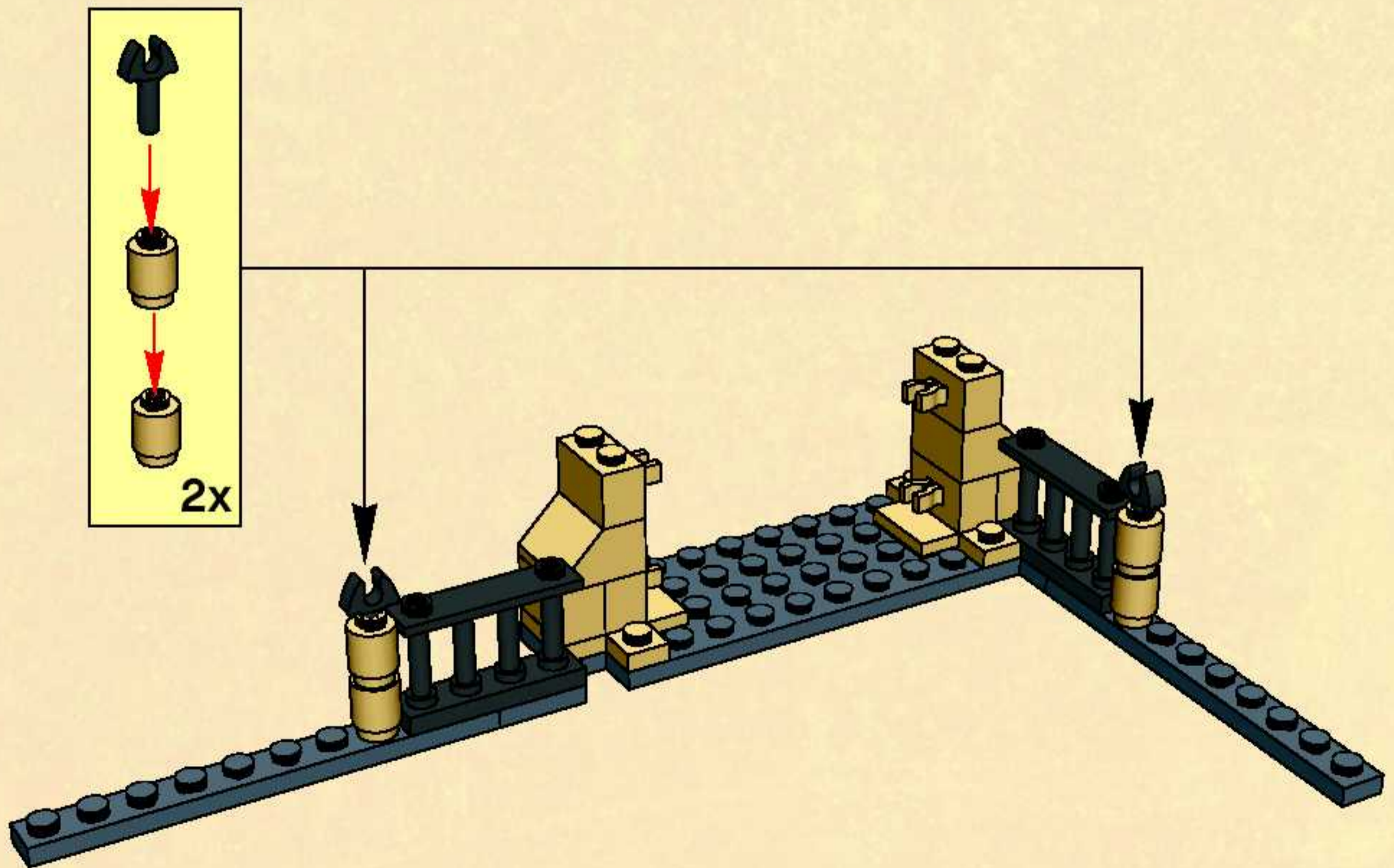

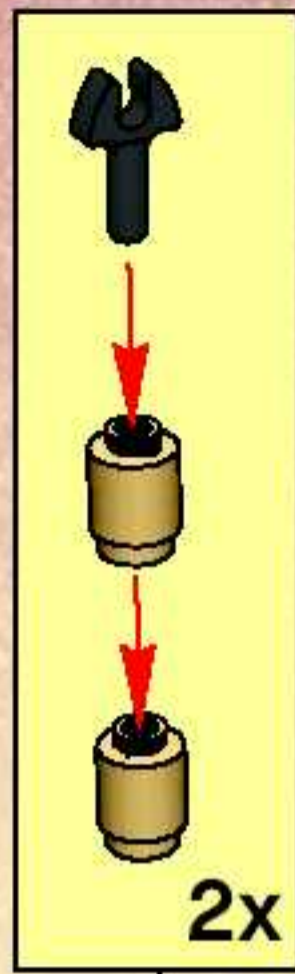

7

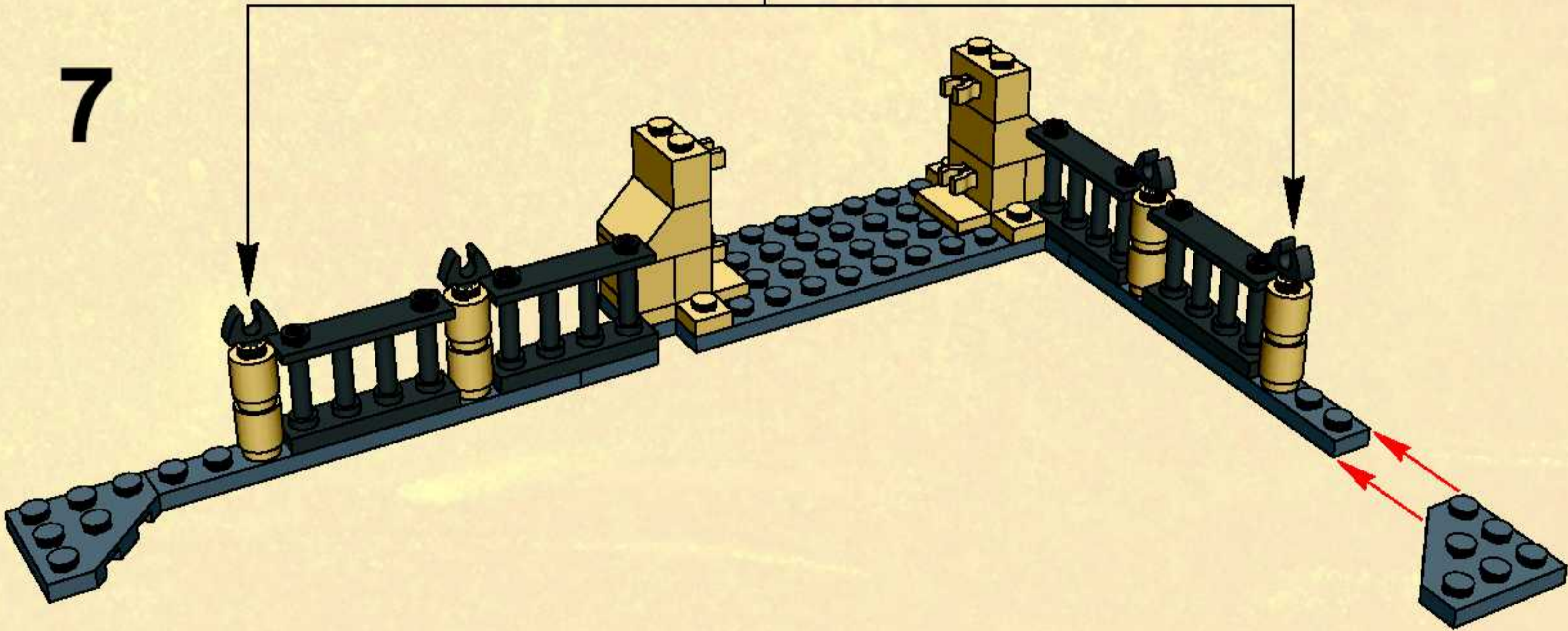

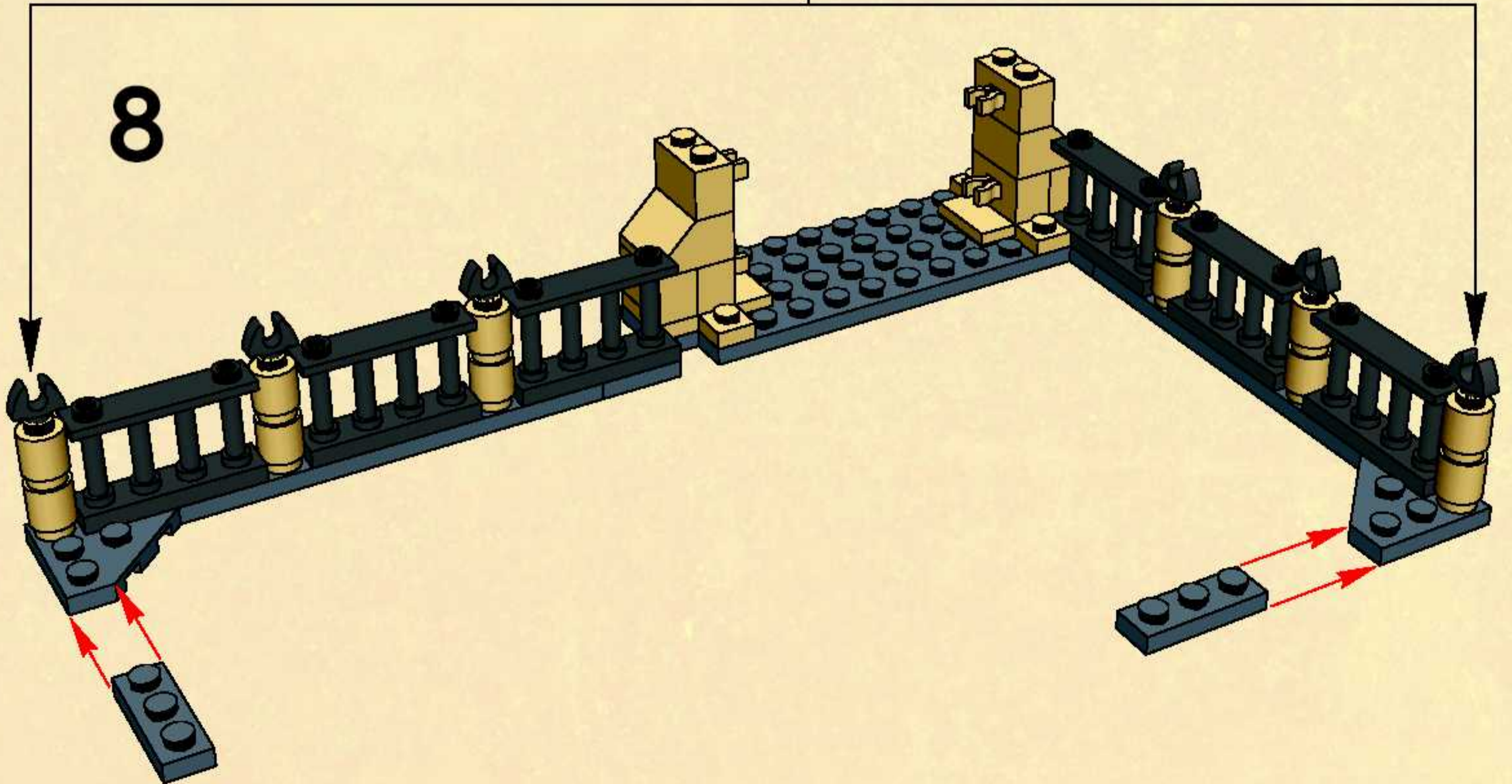
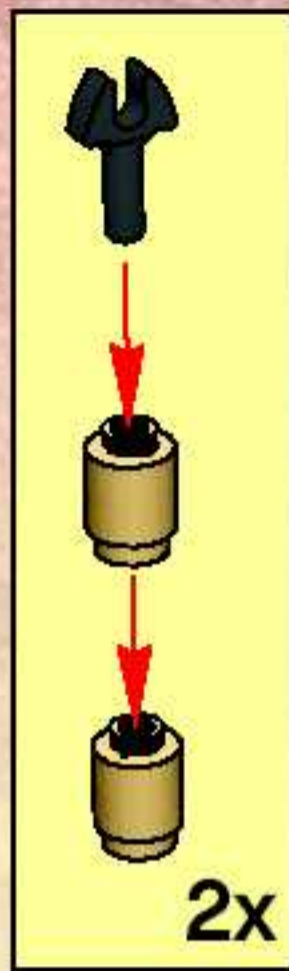

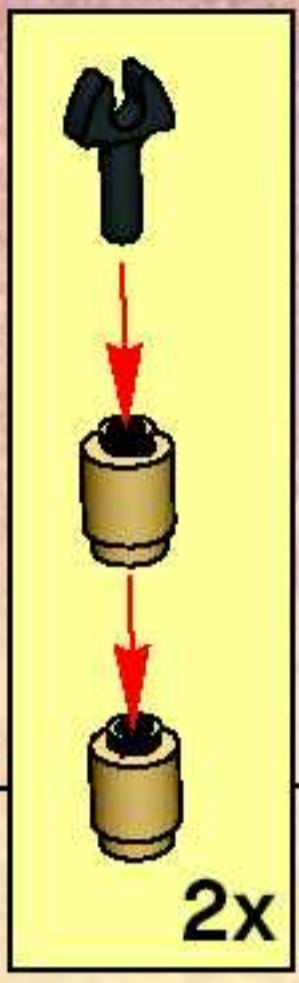

9

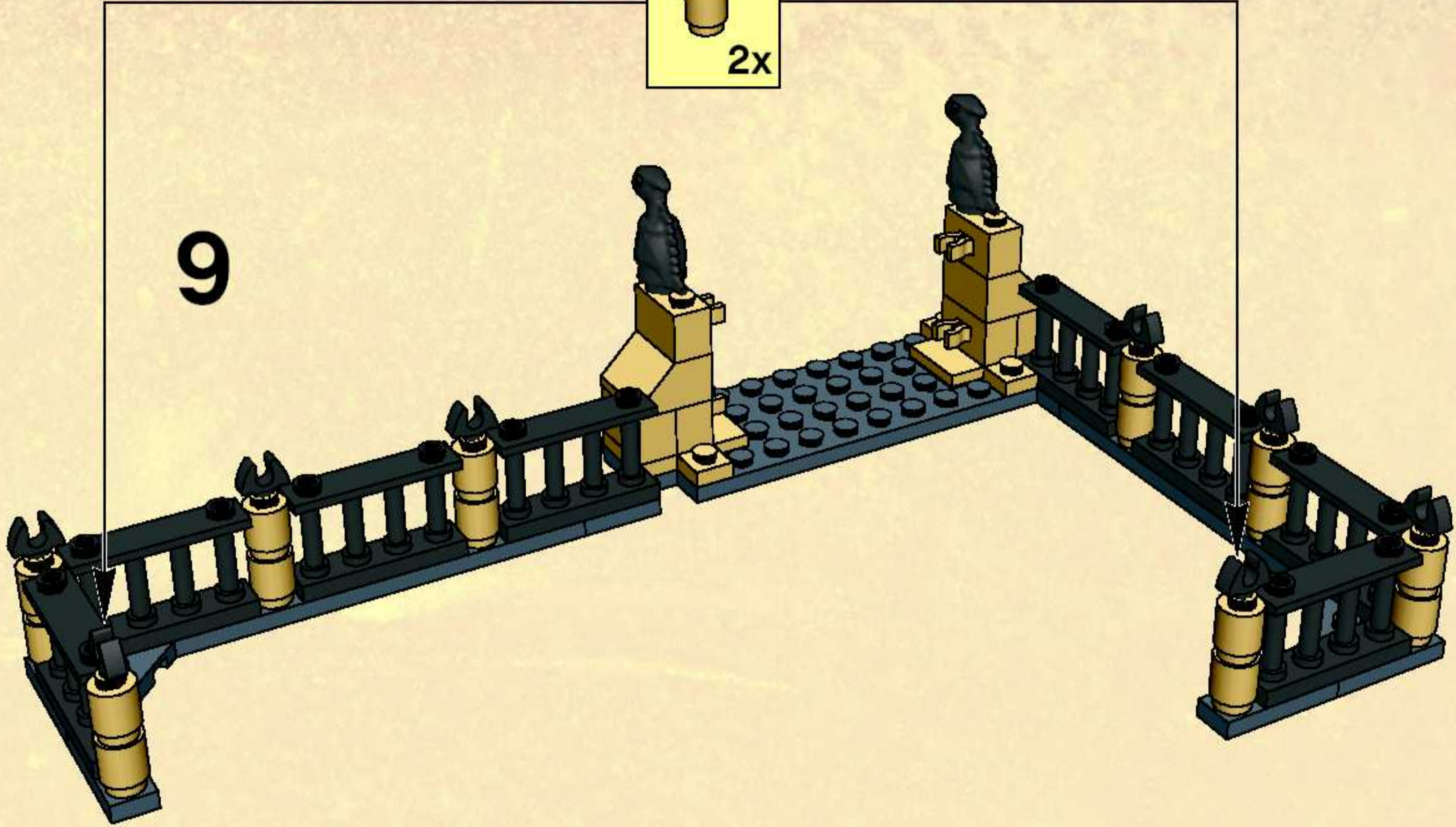

10

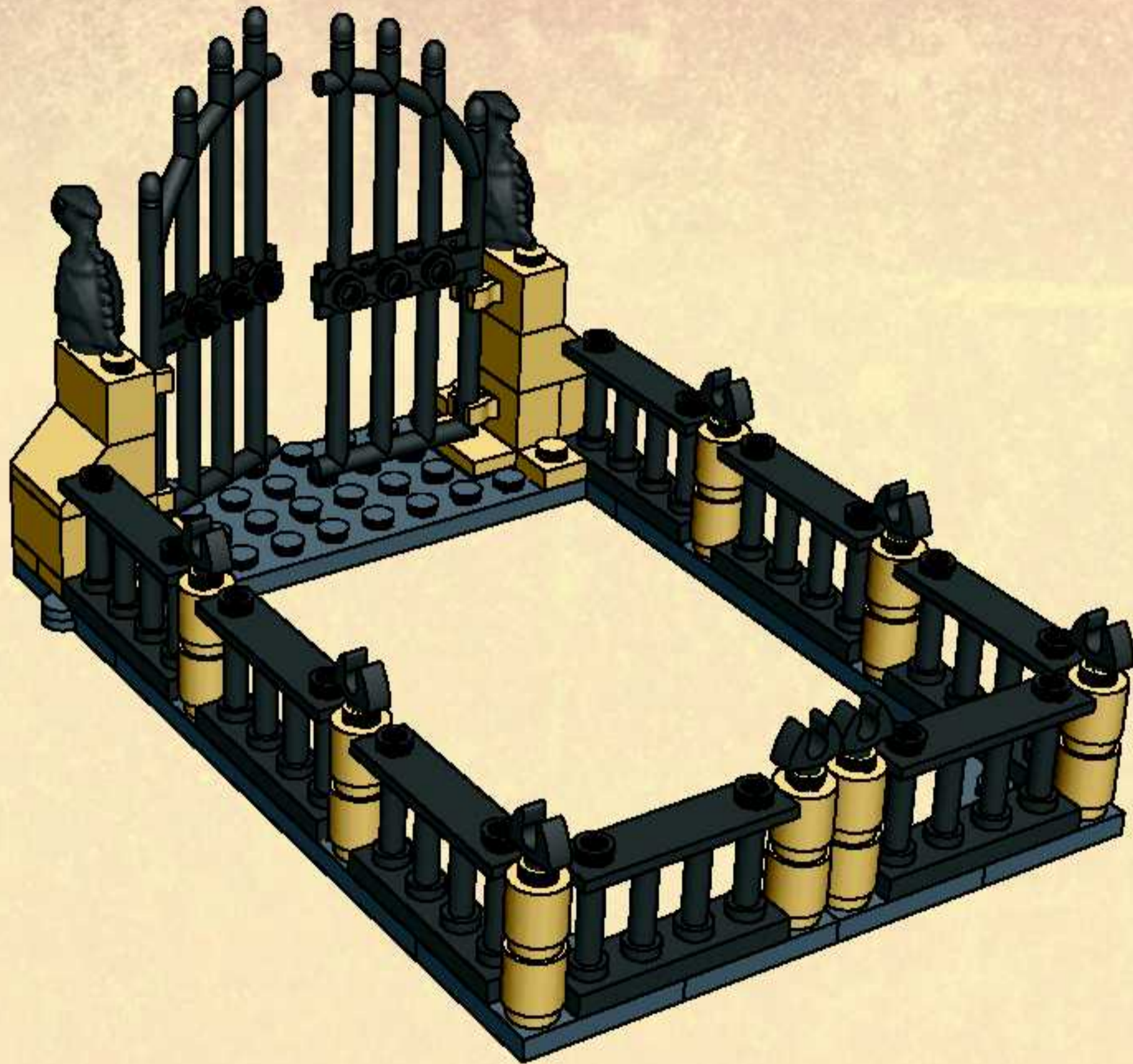

11

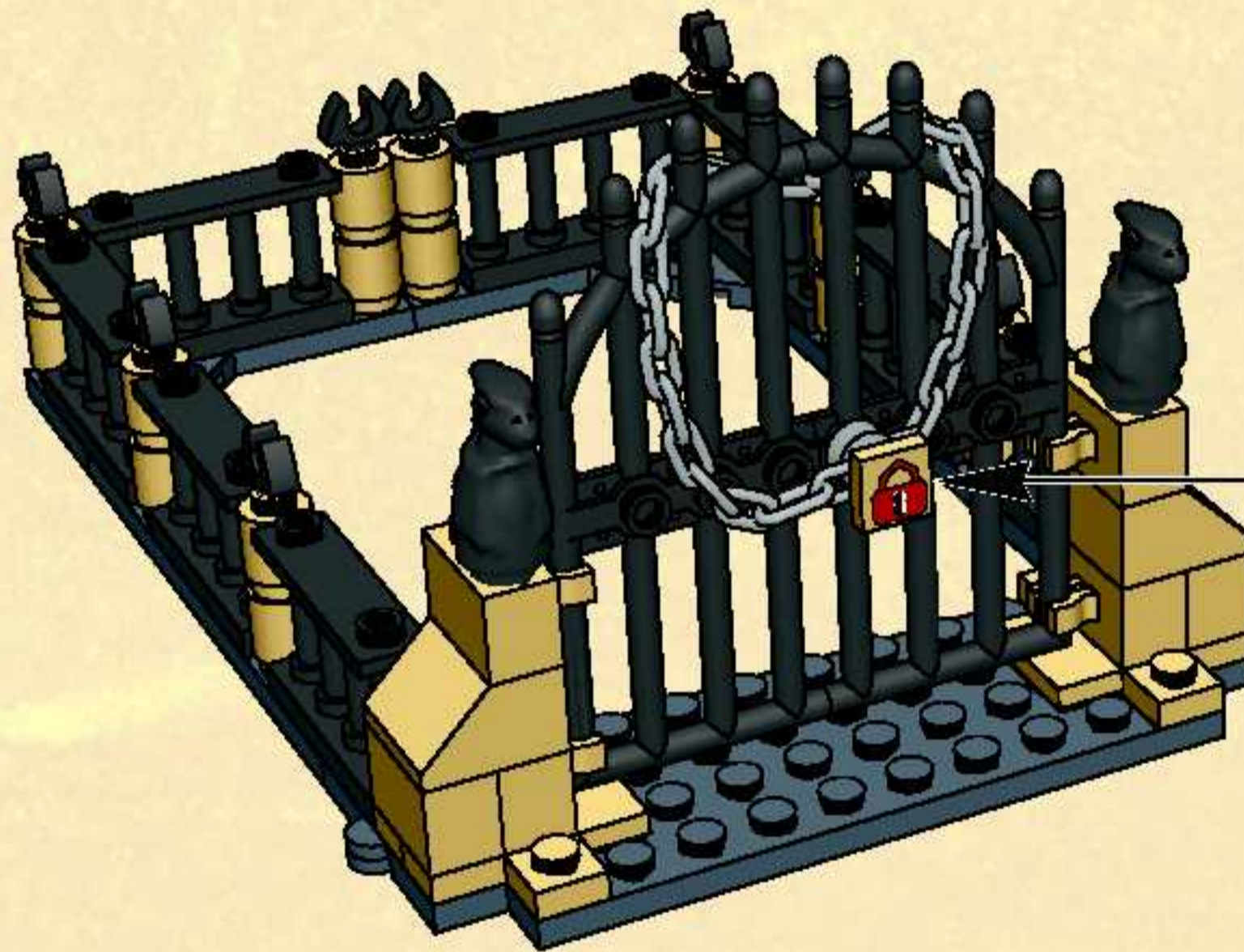
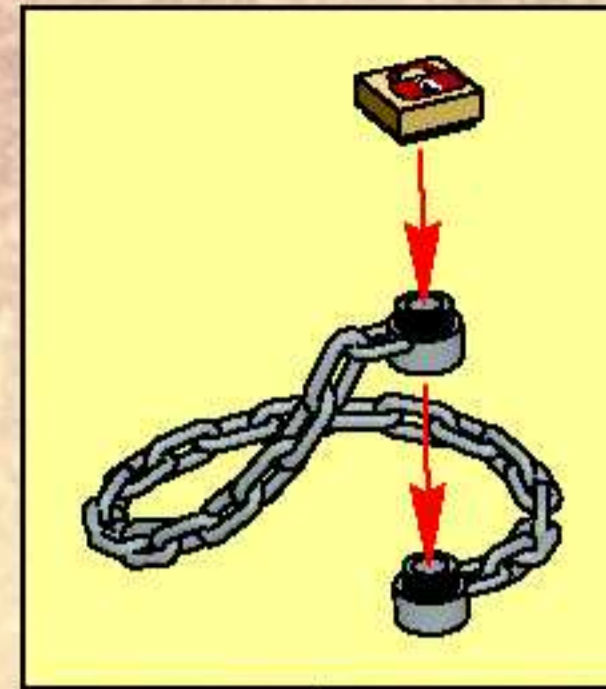

3

3

3

3

ATTENTION: Pour éviter tout risque de blessure, ne pas utiliser les outils à main nue. Lire attentivement les instructions de montage et les avertissements de sécurité. Les pièces de construction peuvent être chaudes après utilisation. Éviter de toucher les surfaces chaudes. Ne pas laisser les enfants jouer seuls avec les pièces de construction. Les pièces de construction peuvent être utilisées pour fabriquer des jouets. Les pièces de construction peuvent être utilisées pour fabriquer des jouets. Les pièces de construction peuvent être utilisées pour fabriquer des jouets.



1

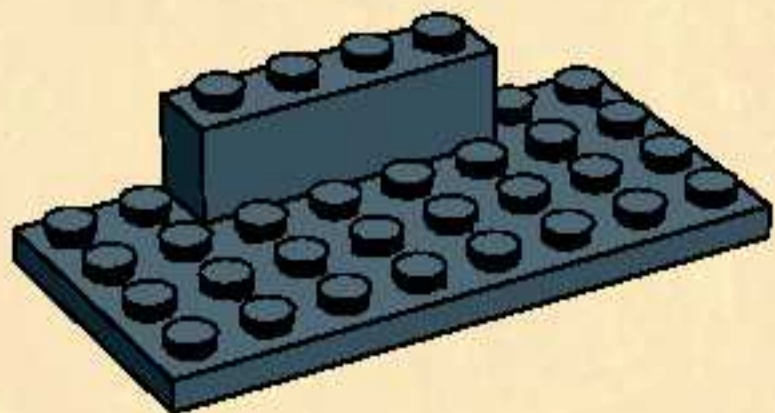

2

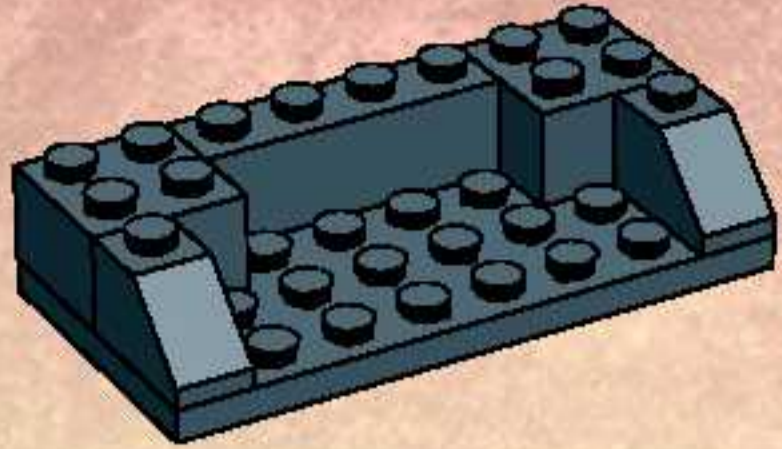

3

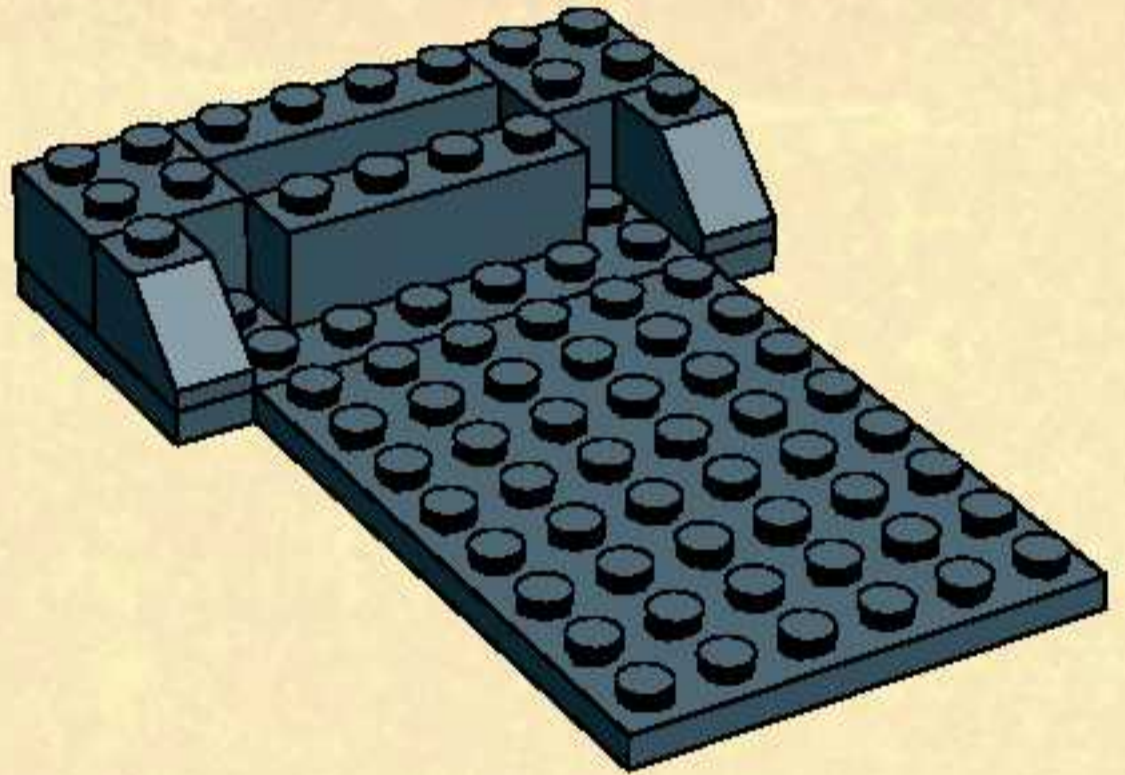

4

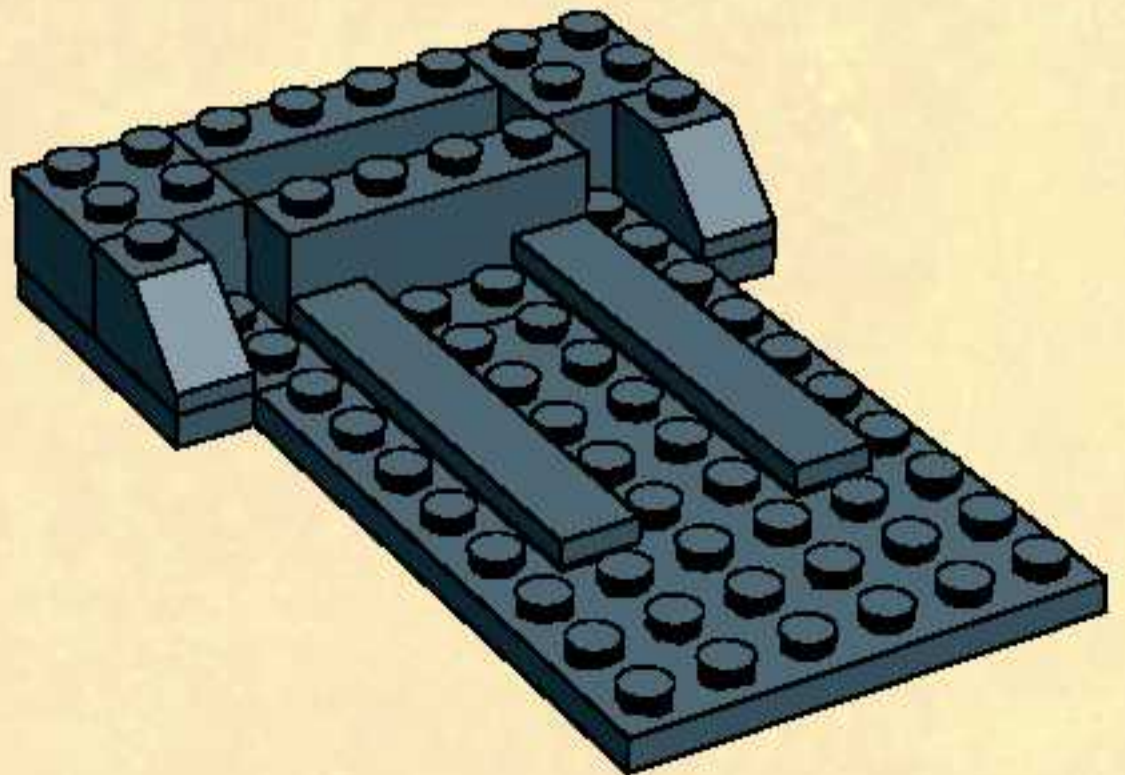

5

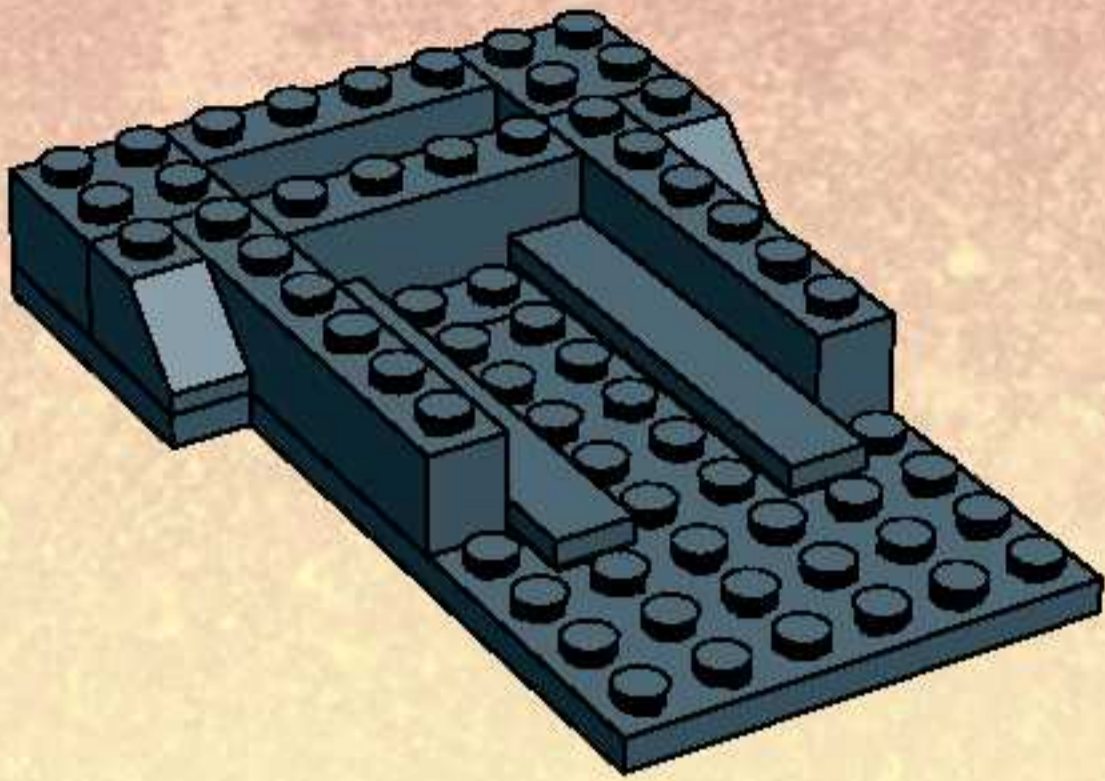

7

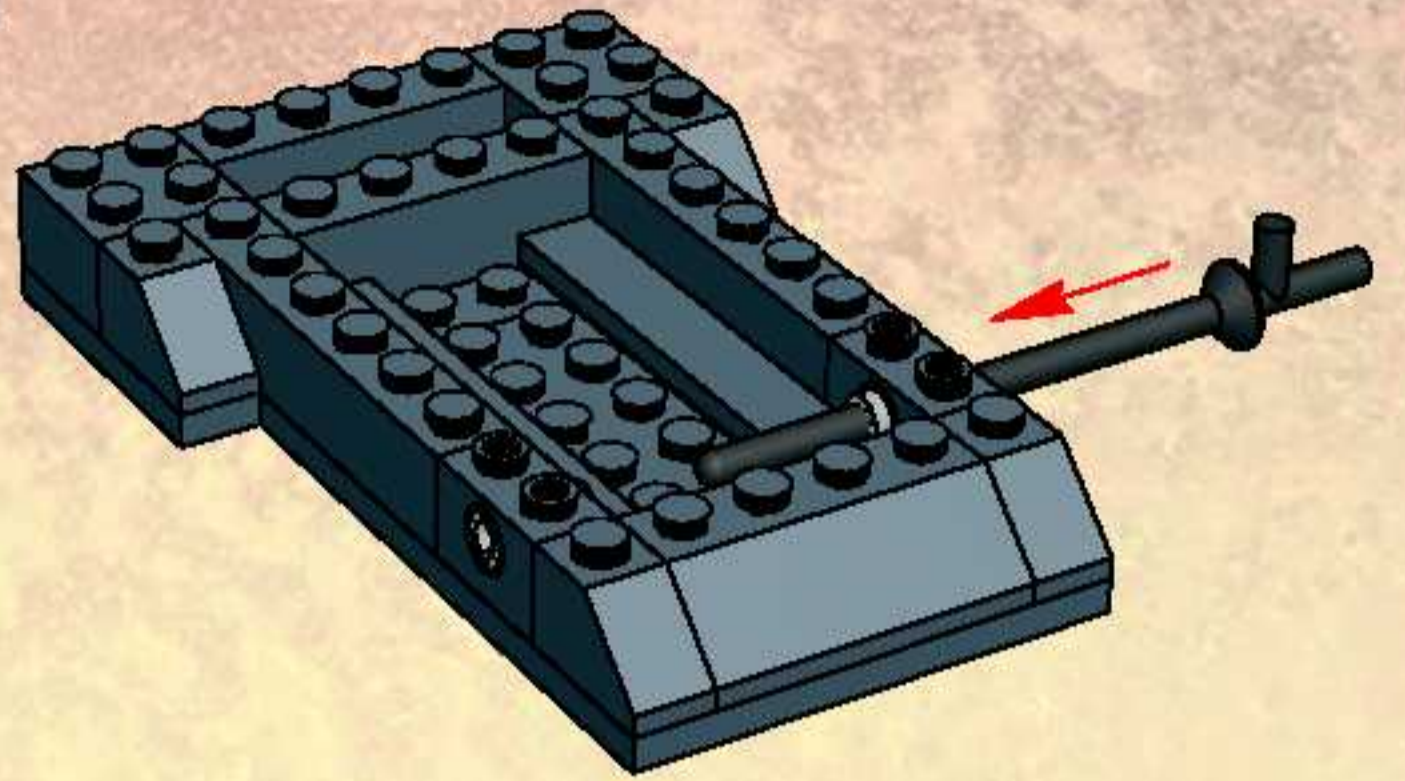

6

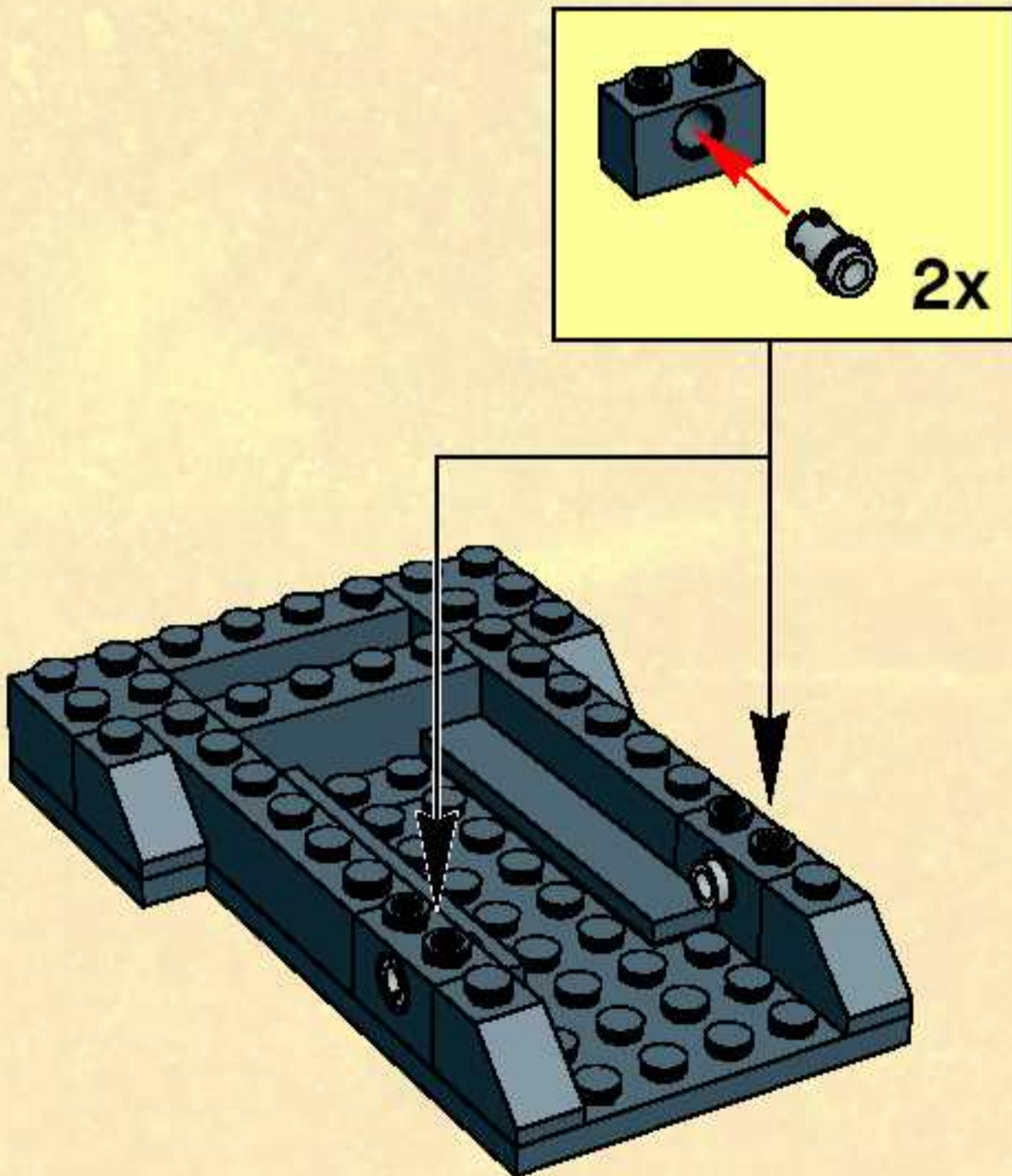

8

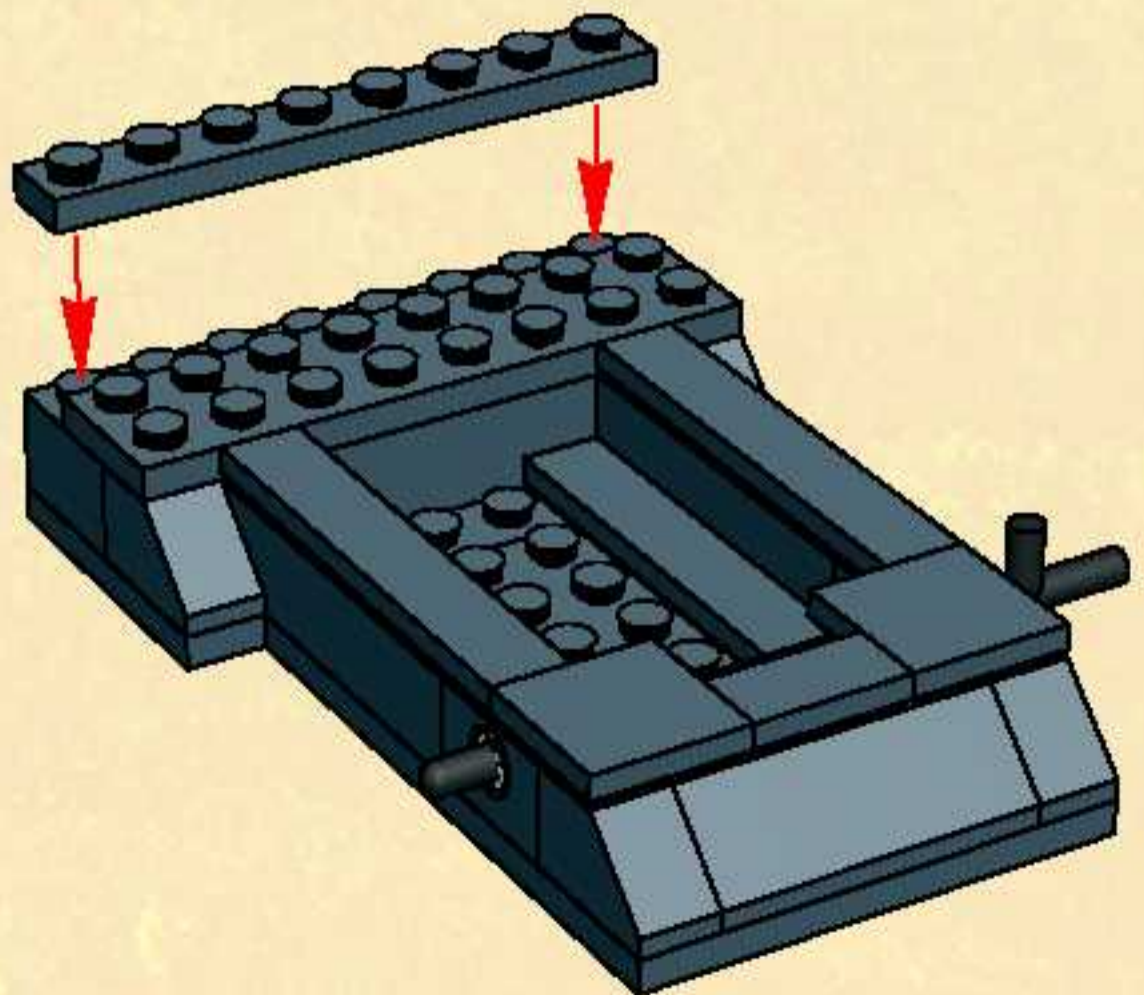

9

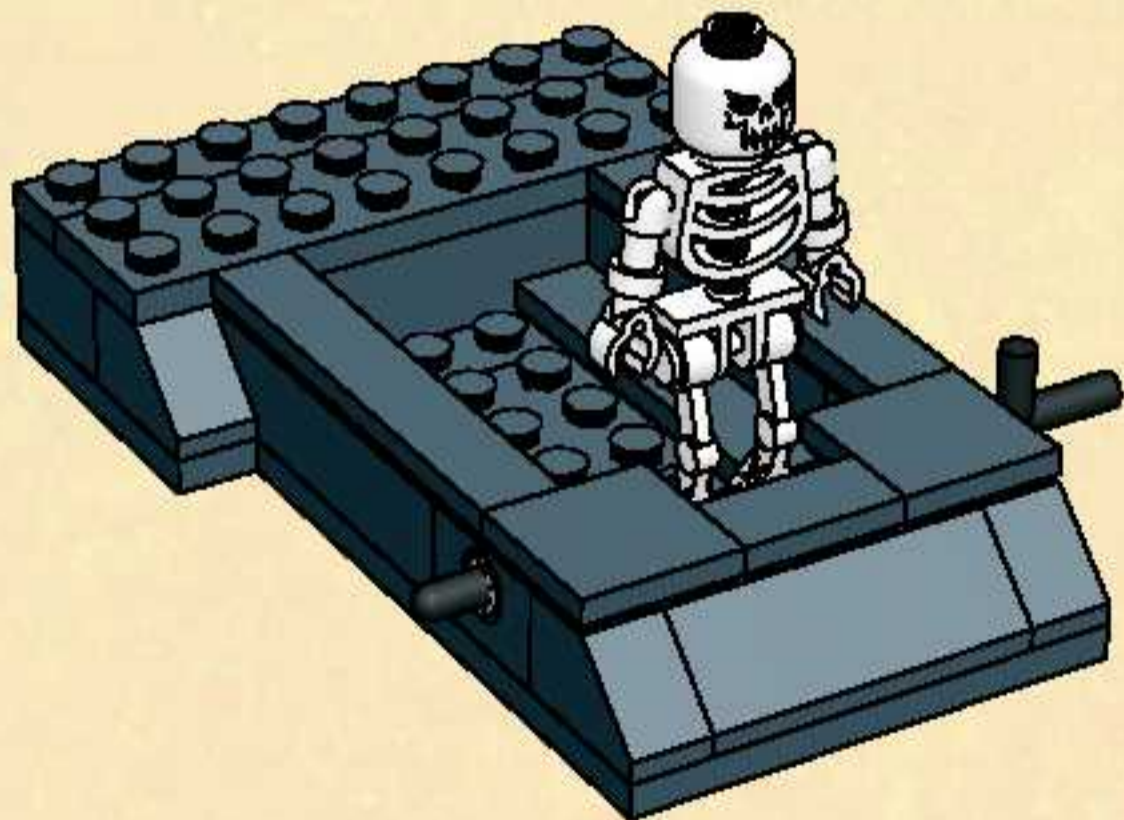
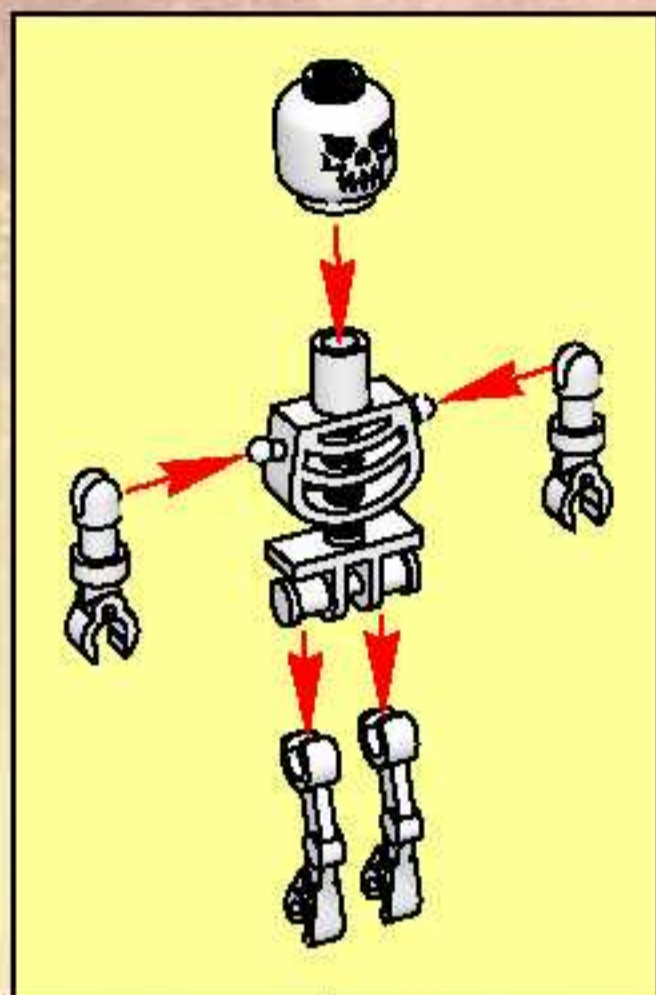

10

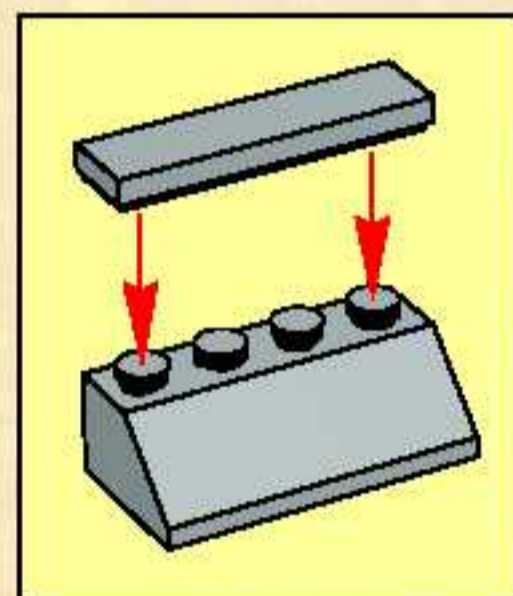
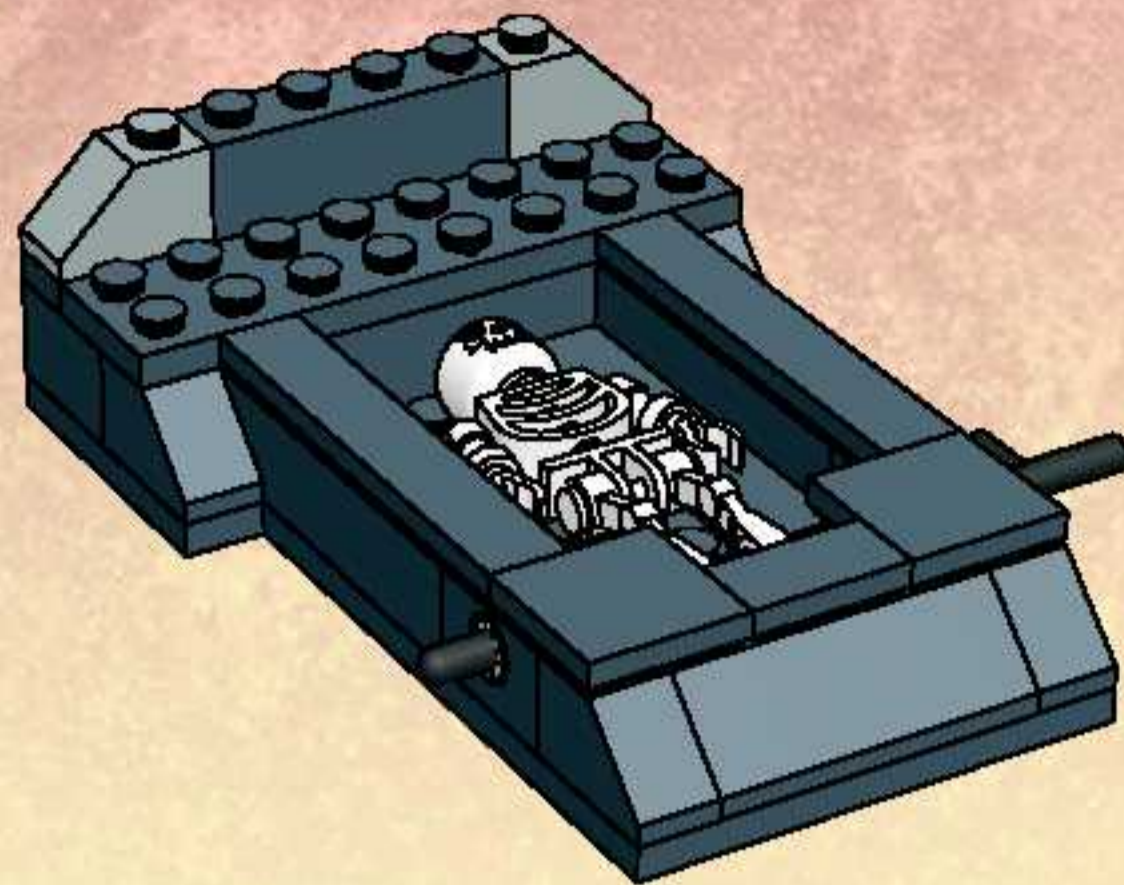

11

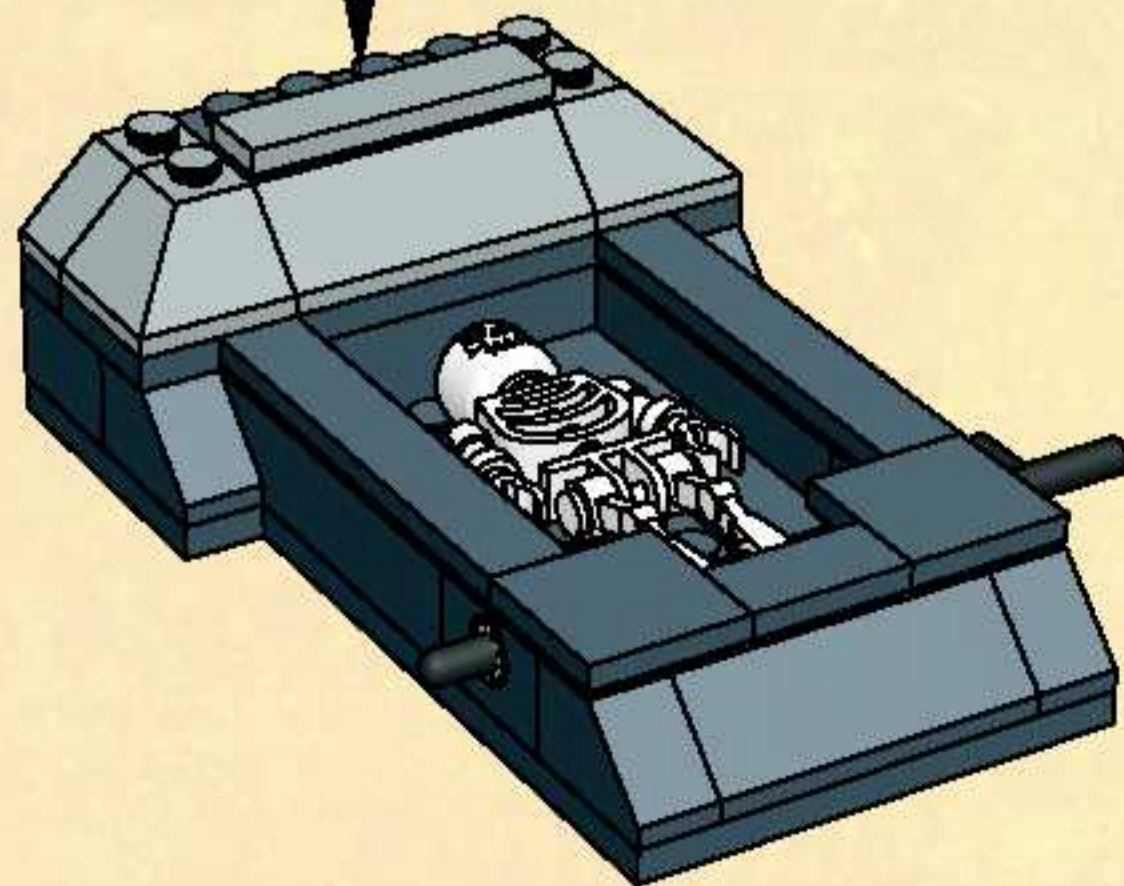

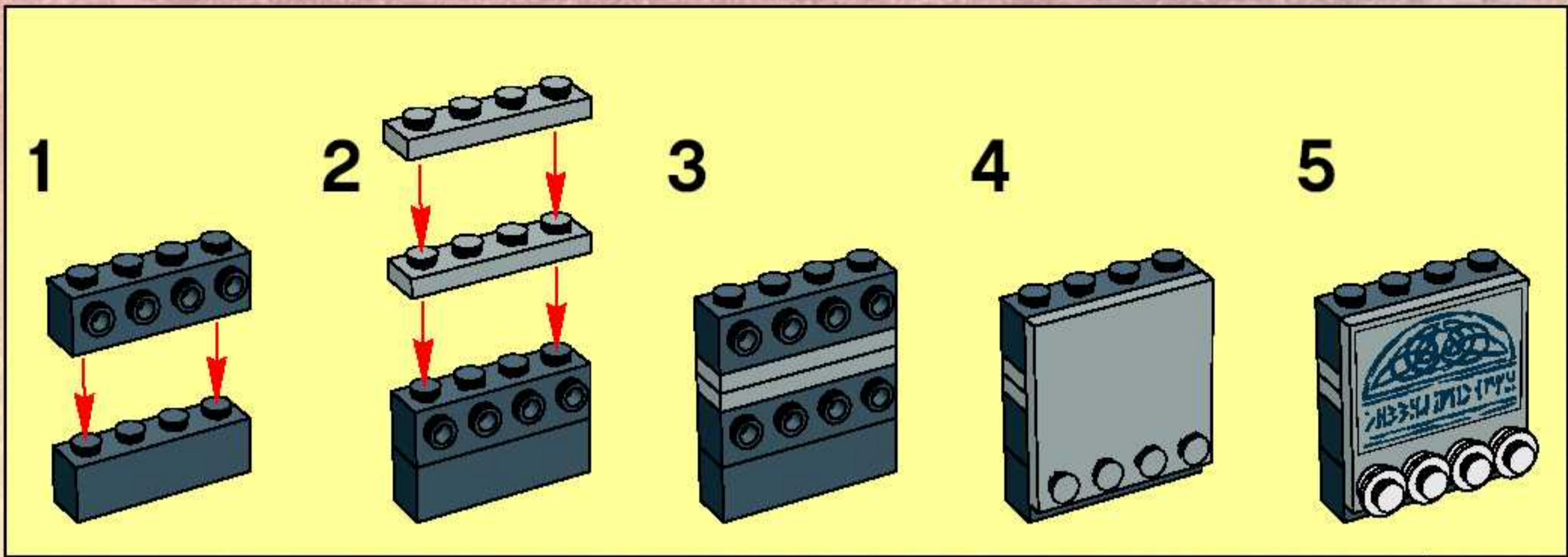

12

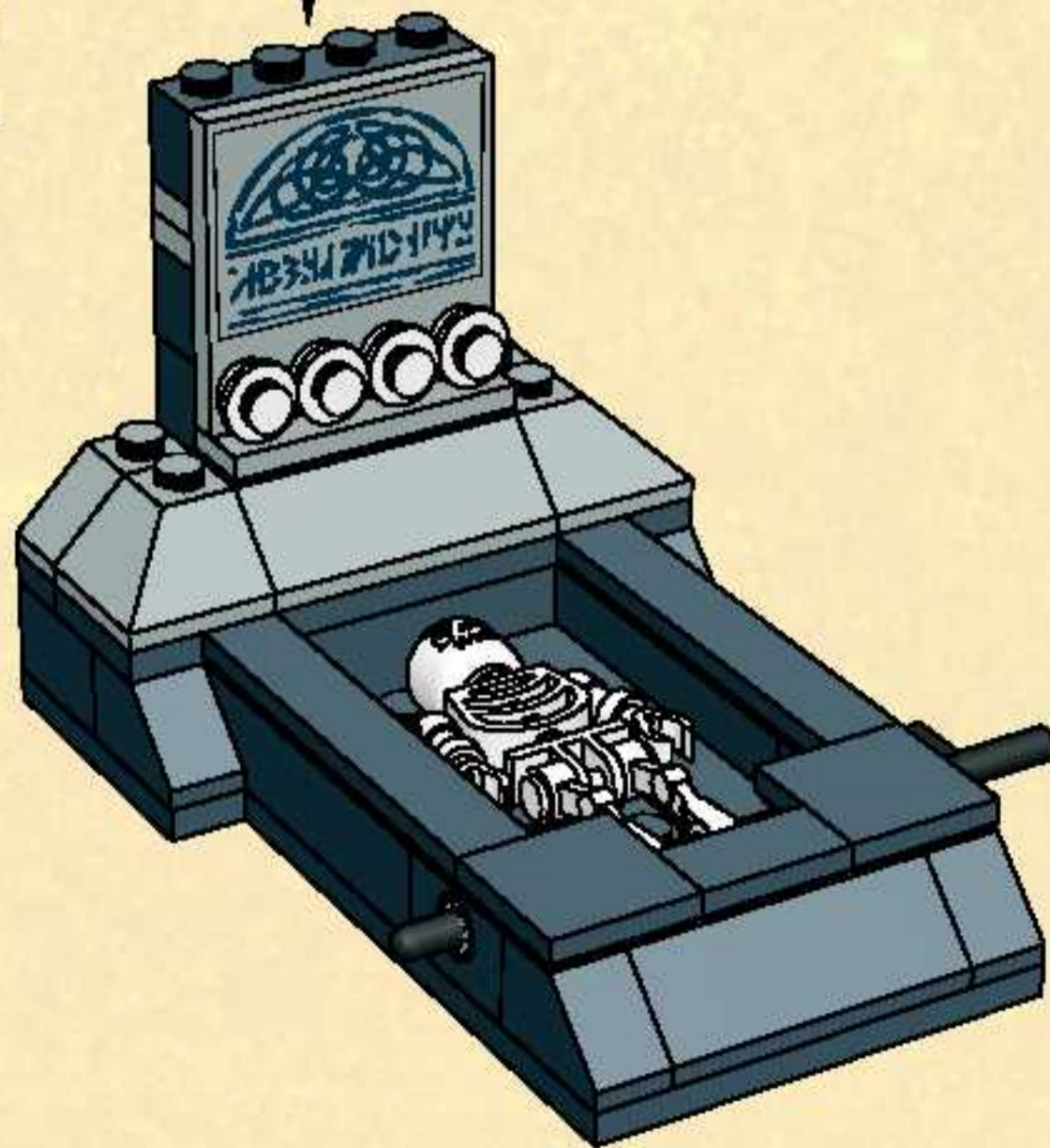

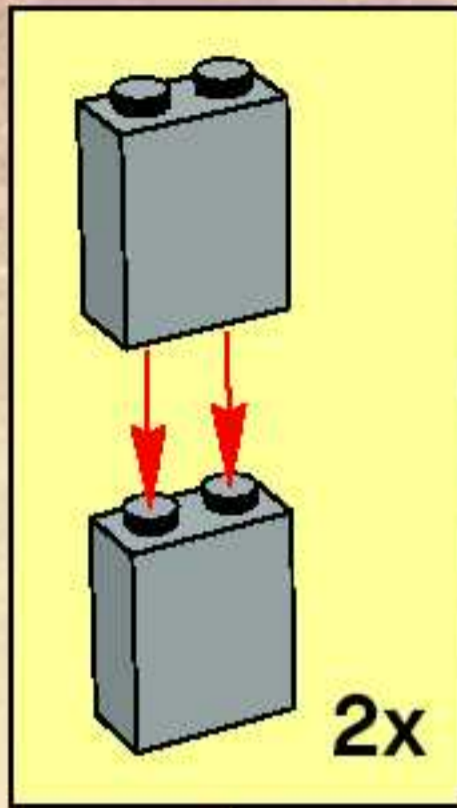

13

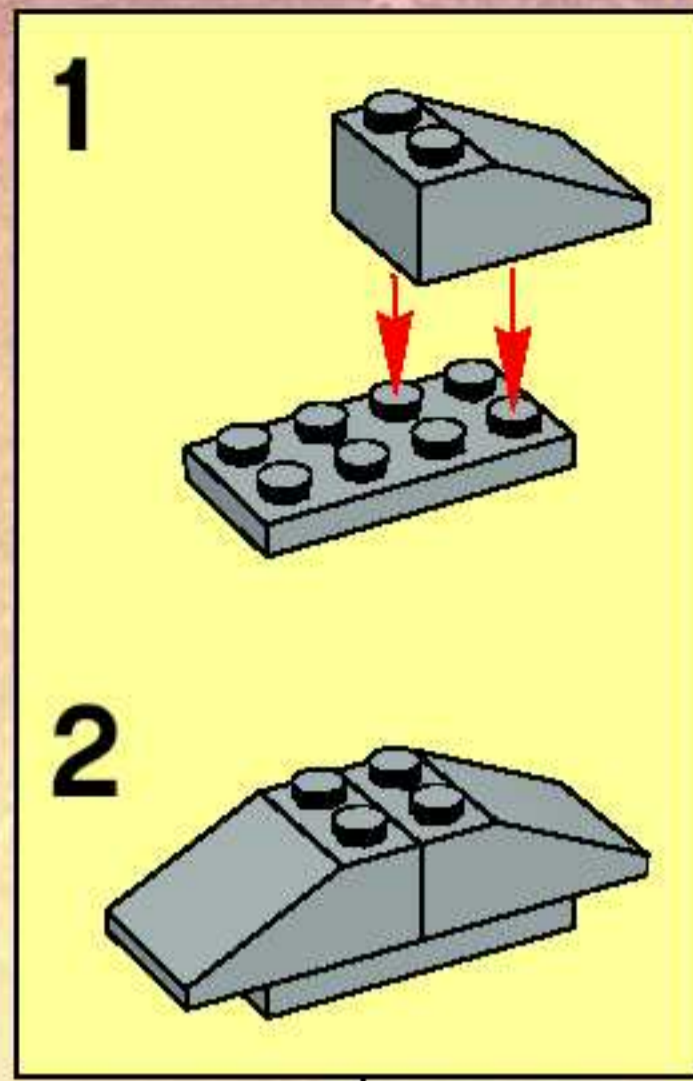
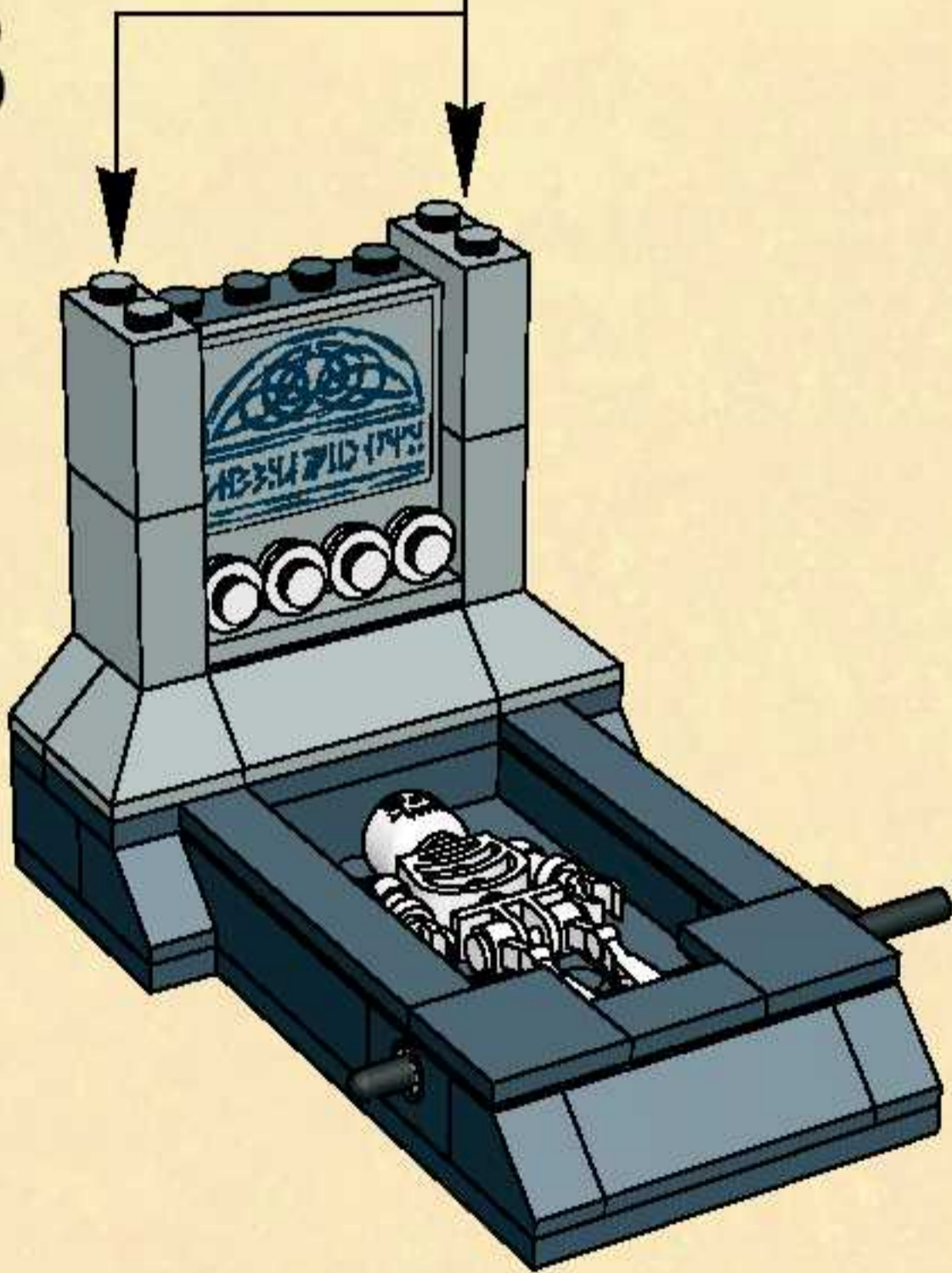

14

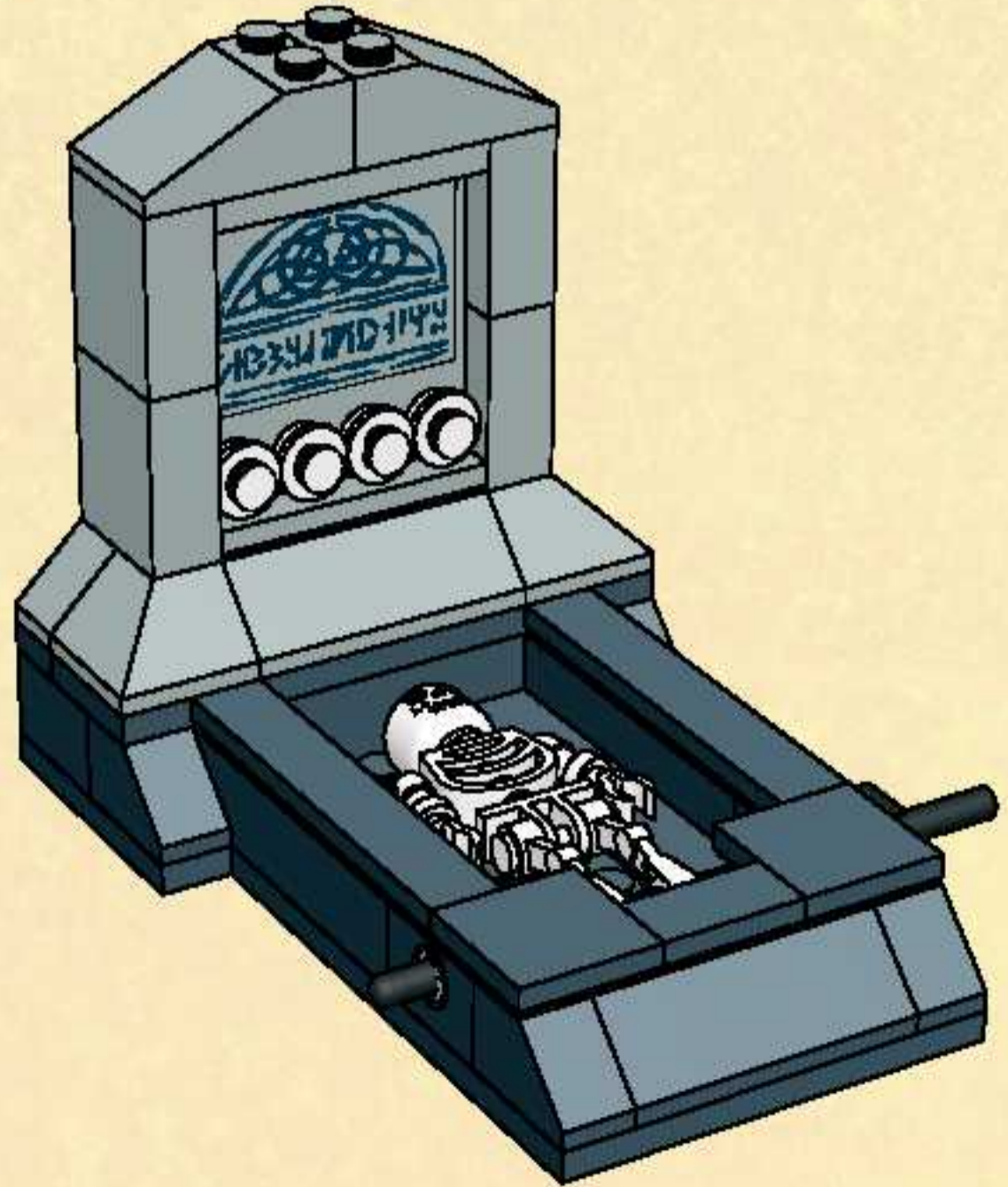

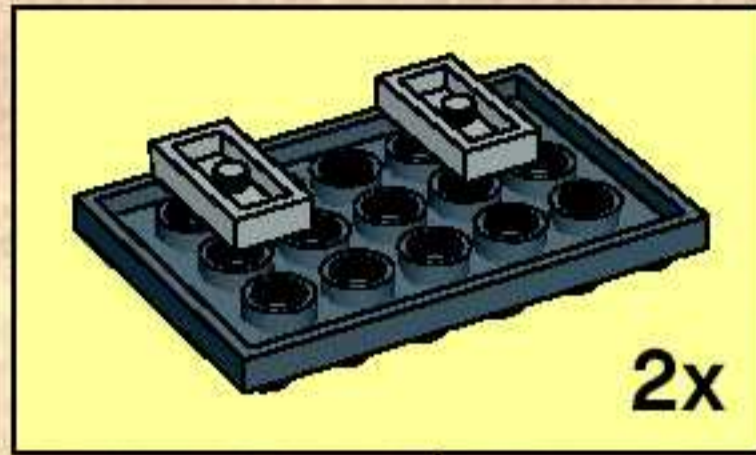

15

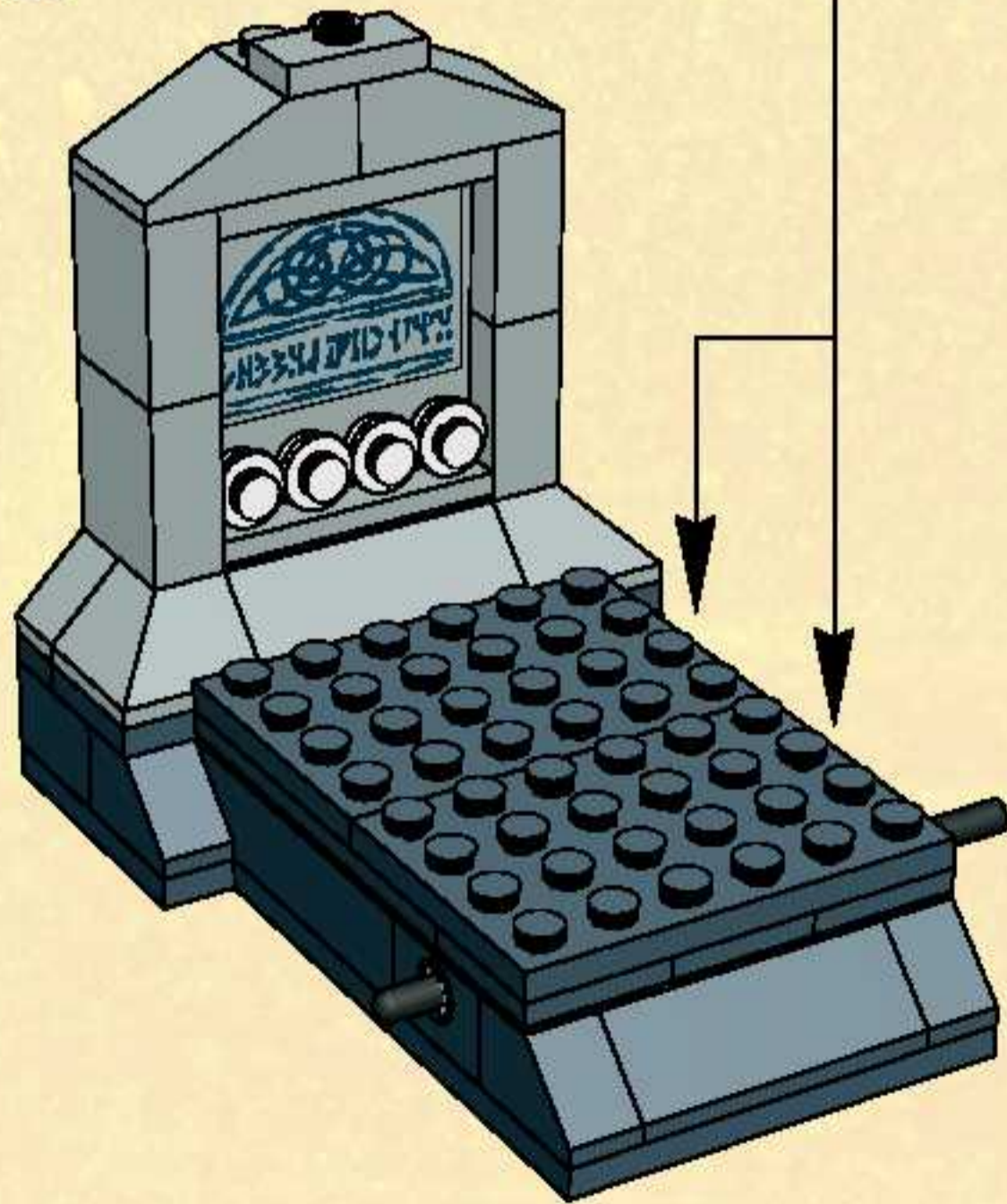

16

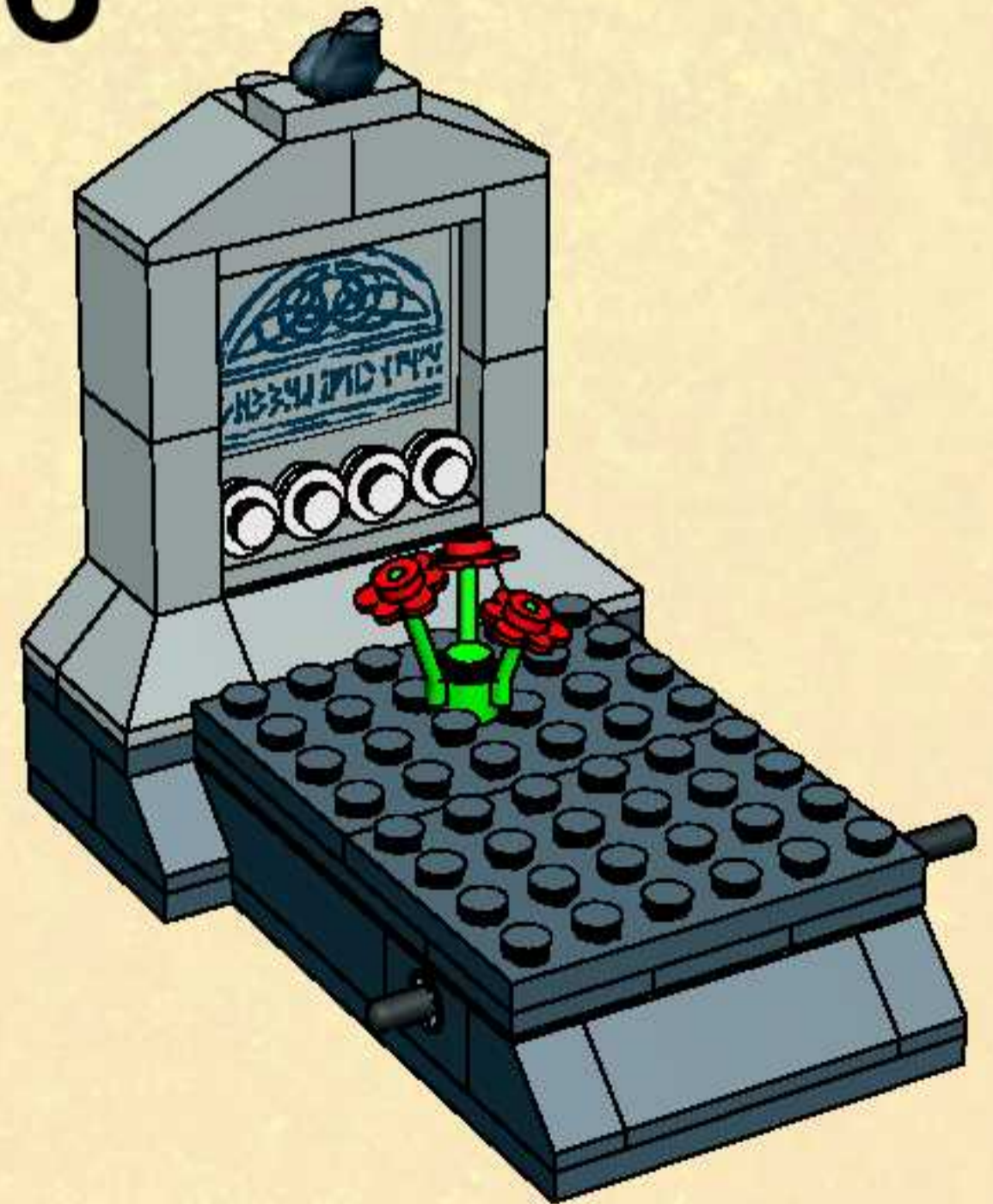



1

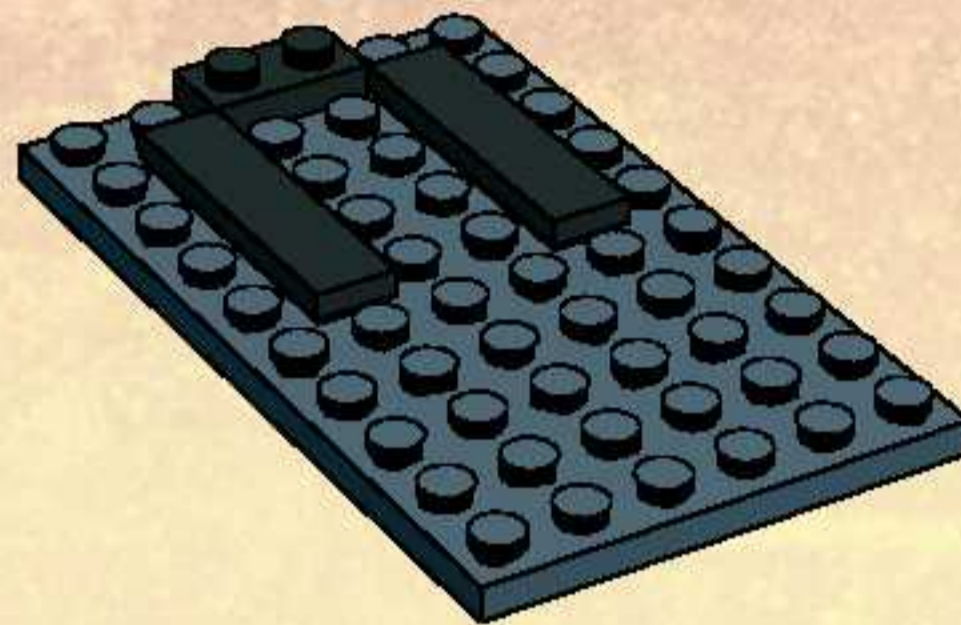

2

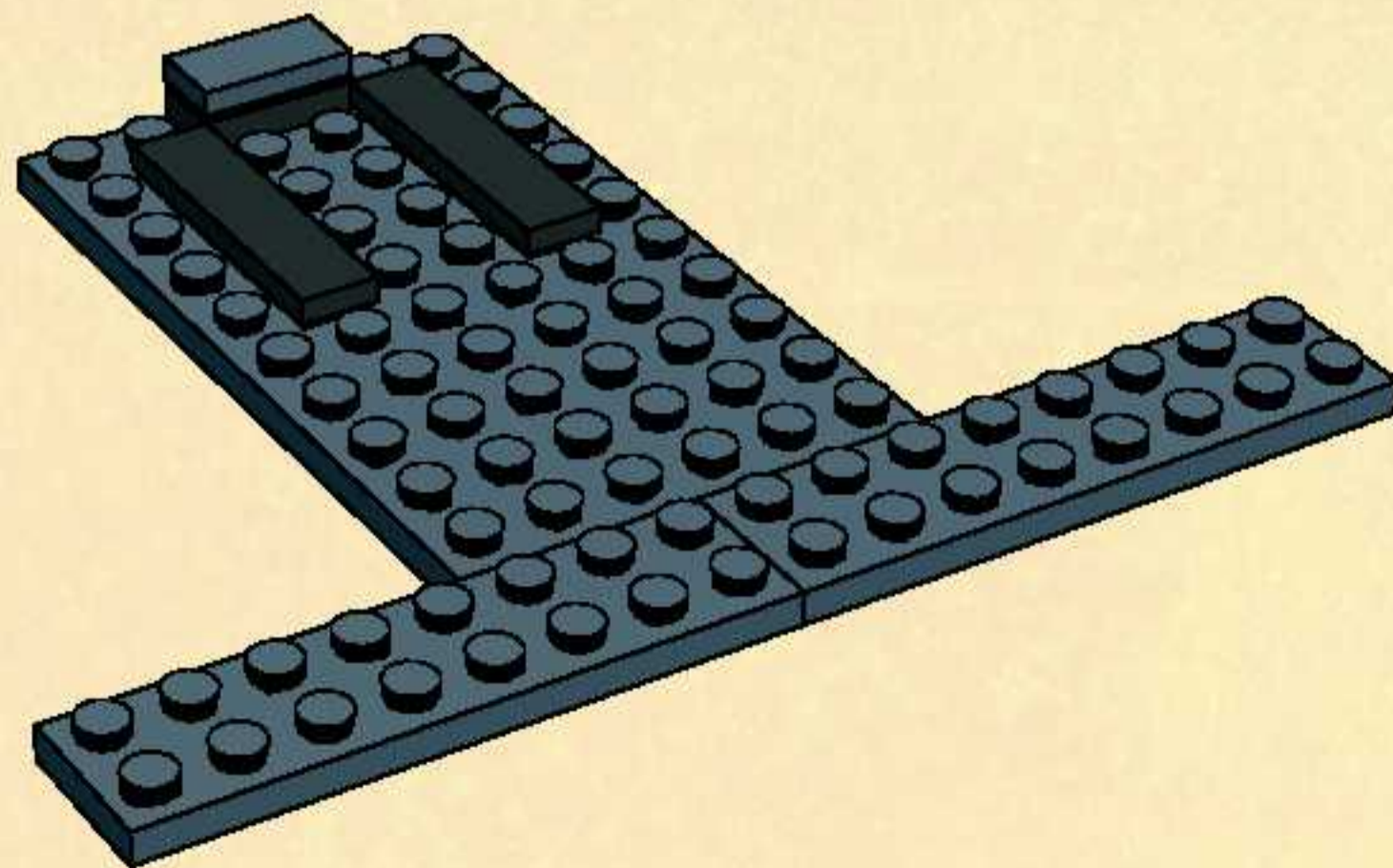

3

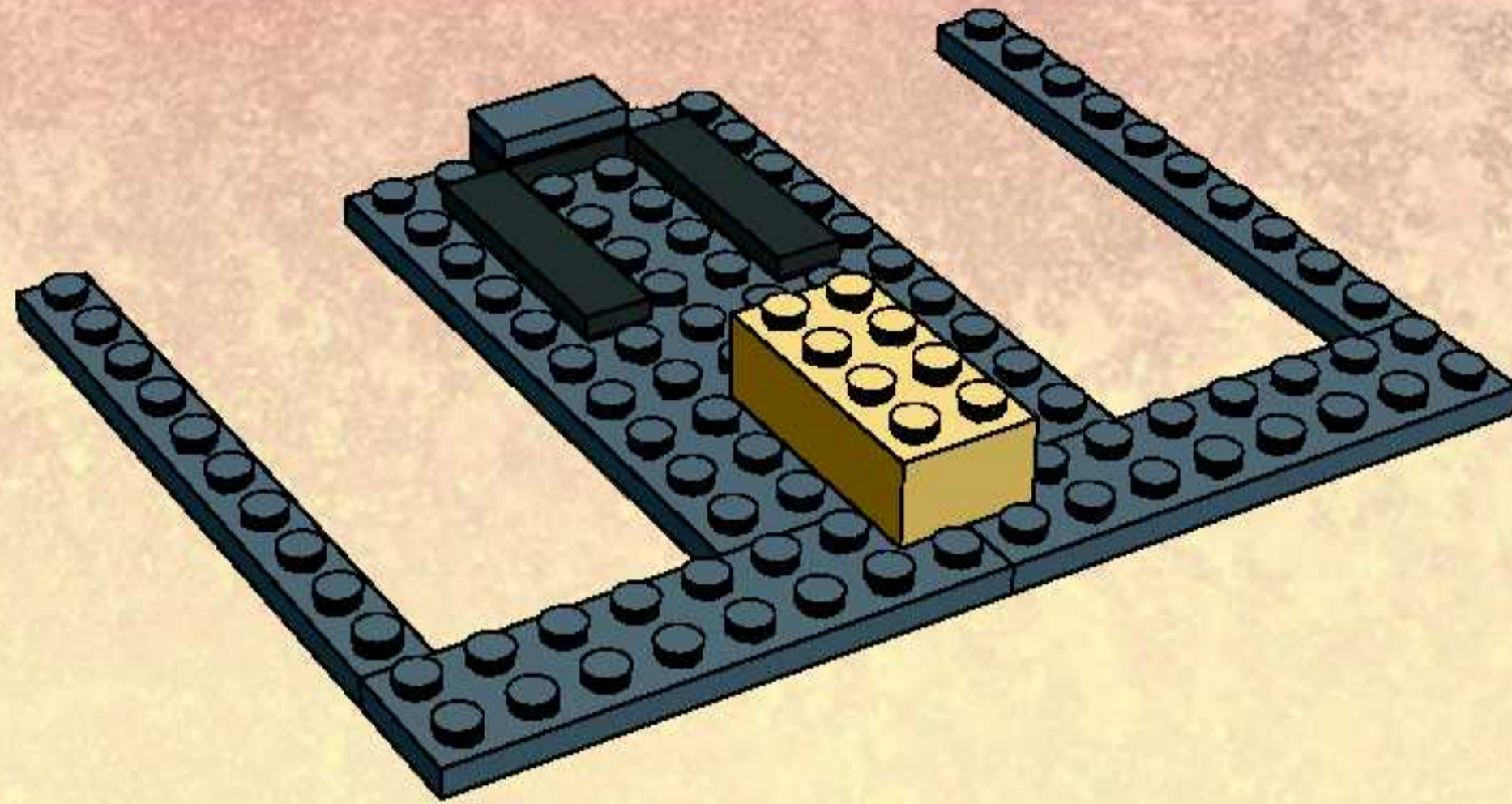

4

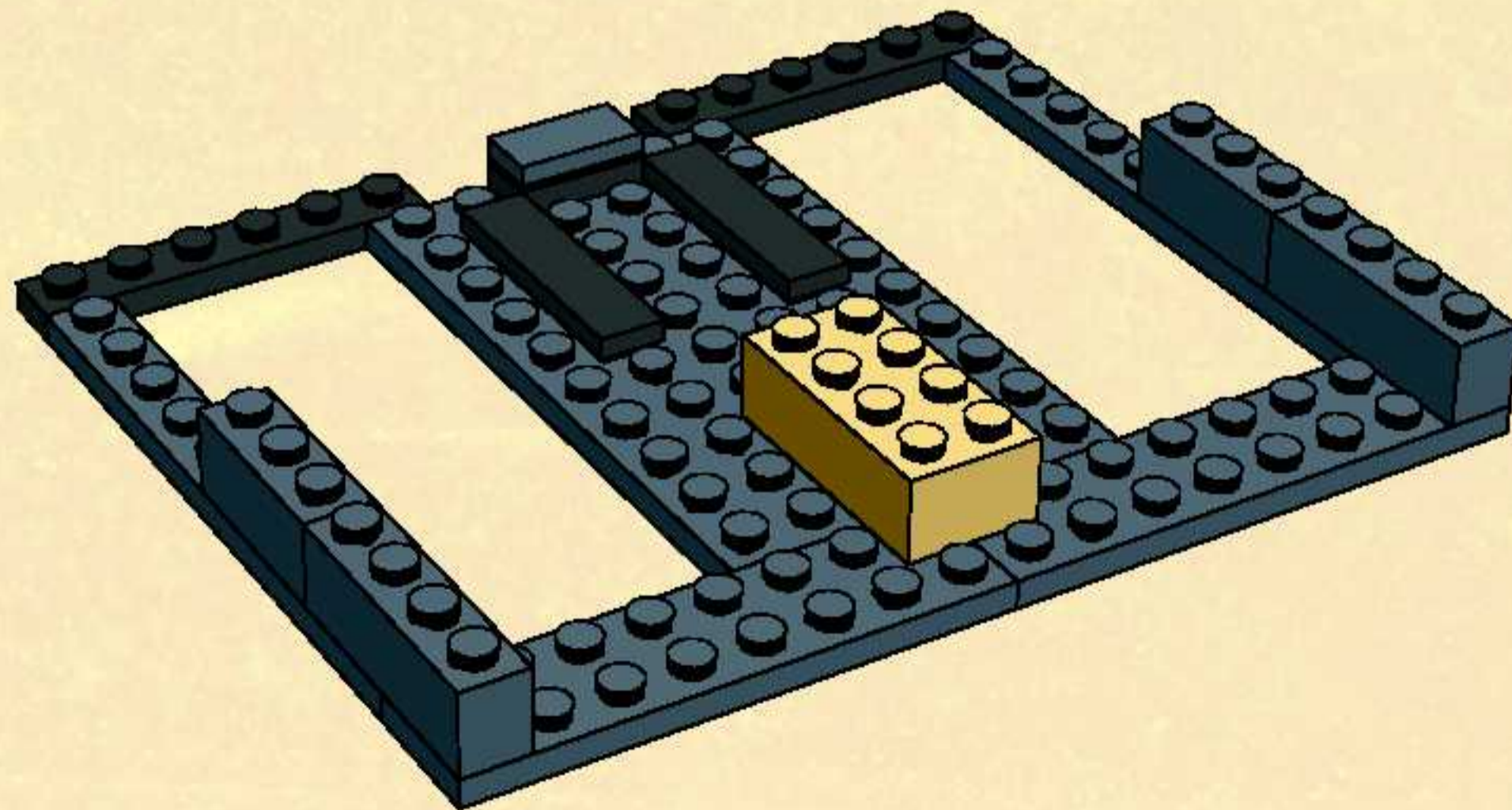

5

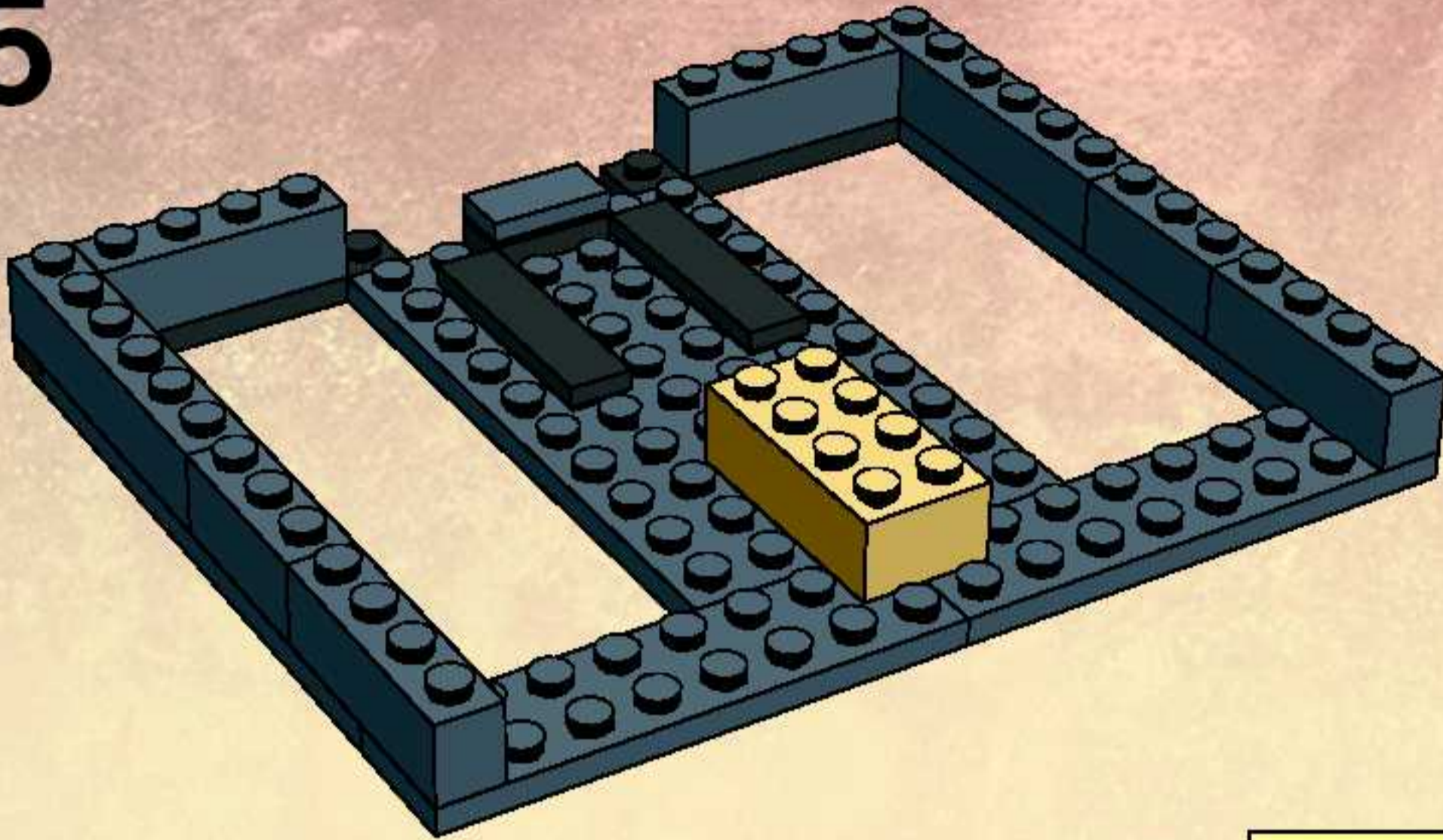

6

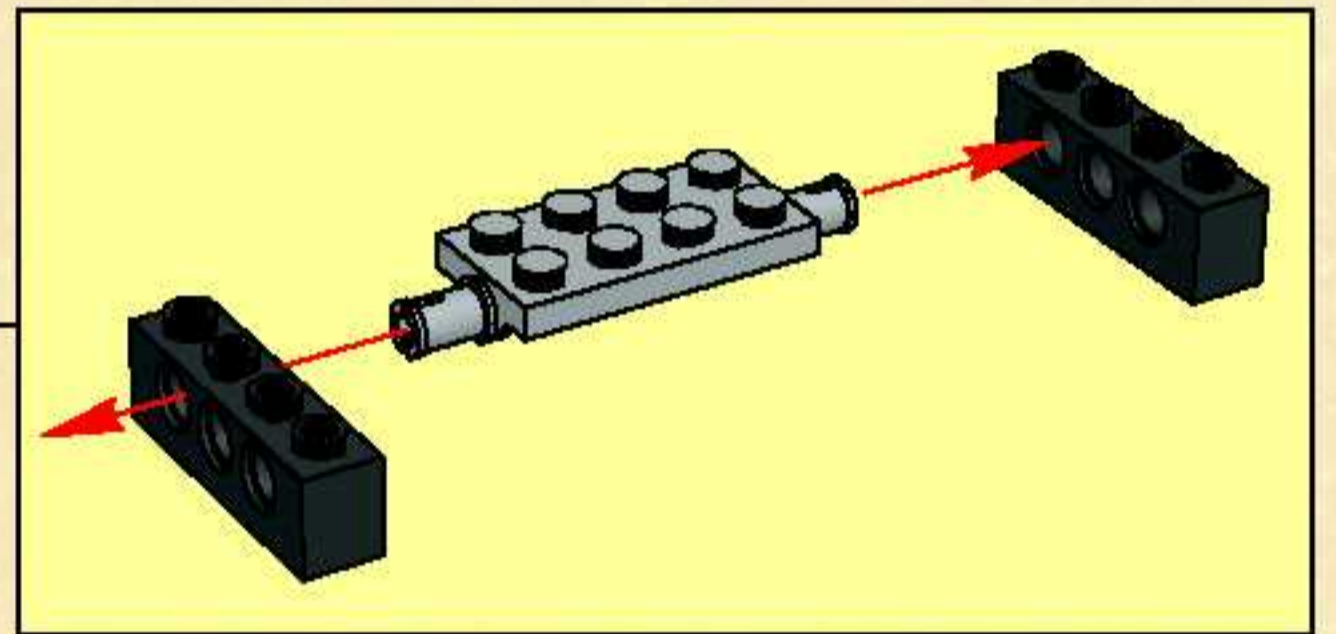
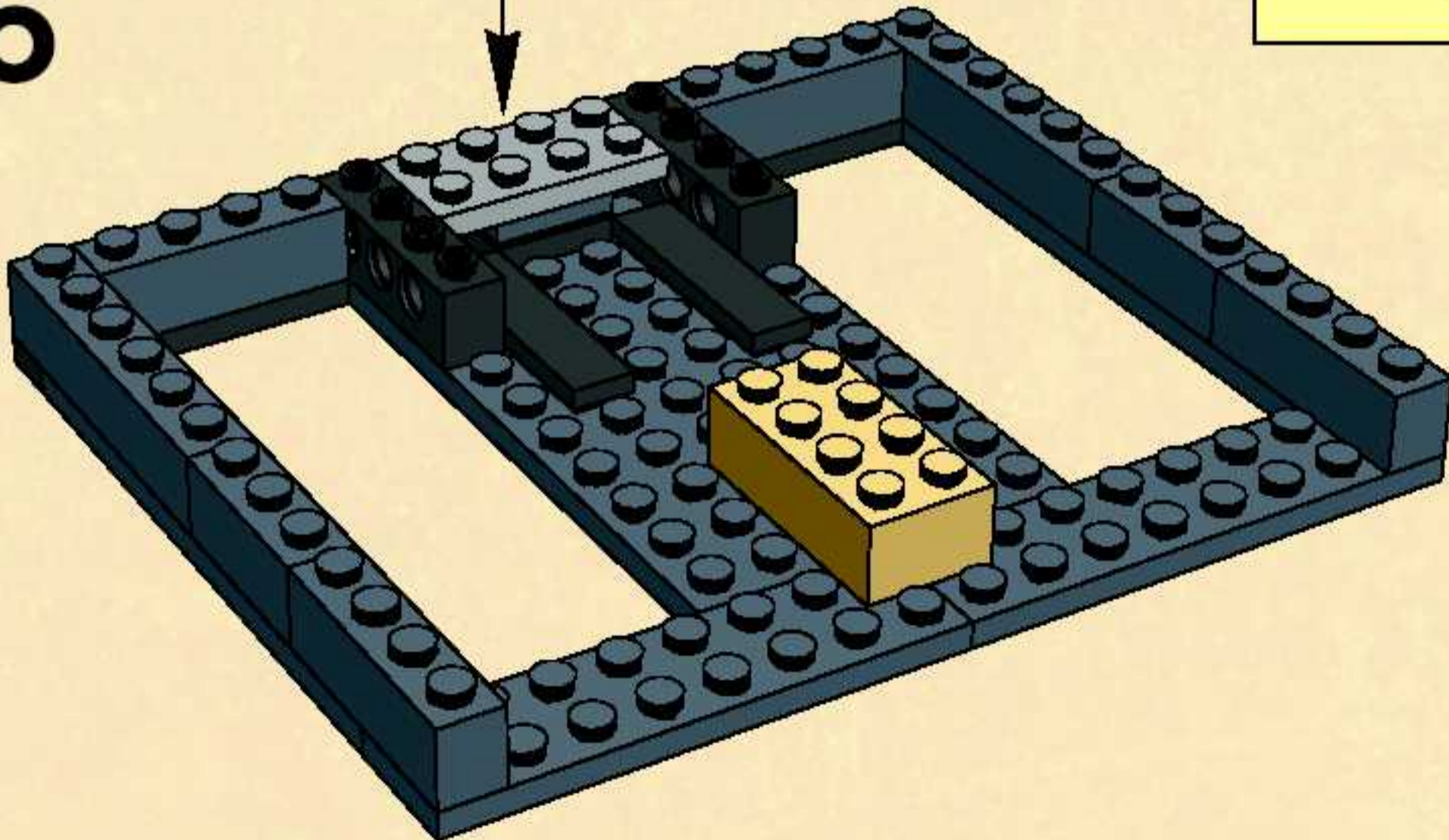

7

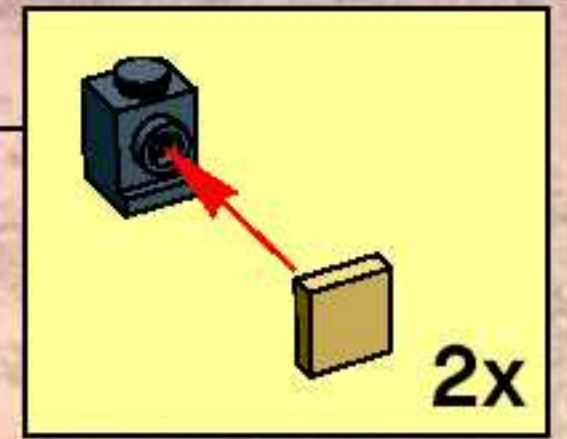
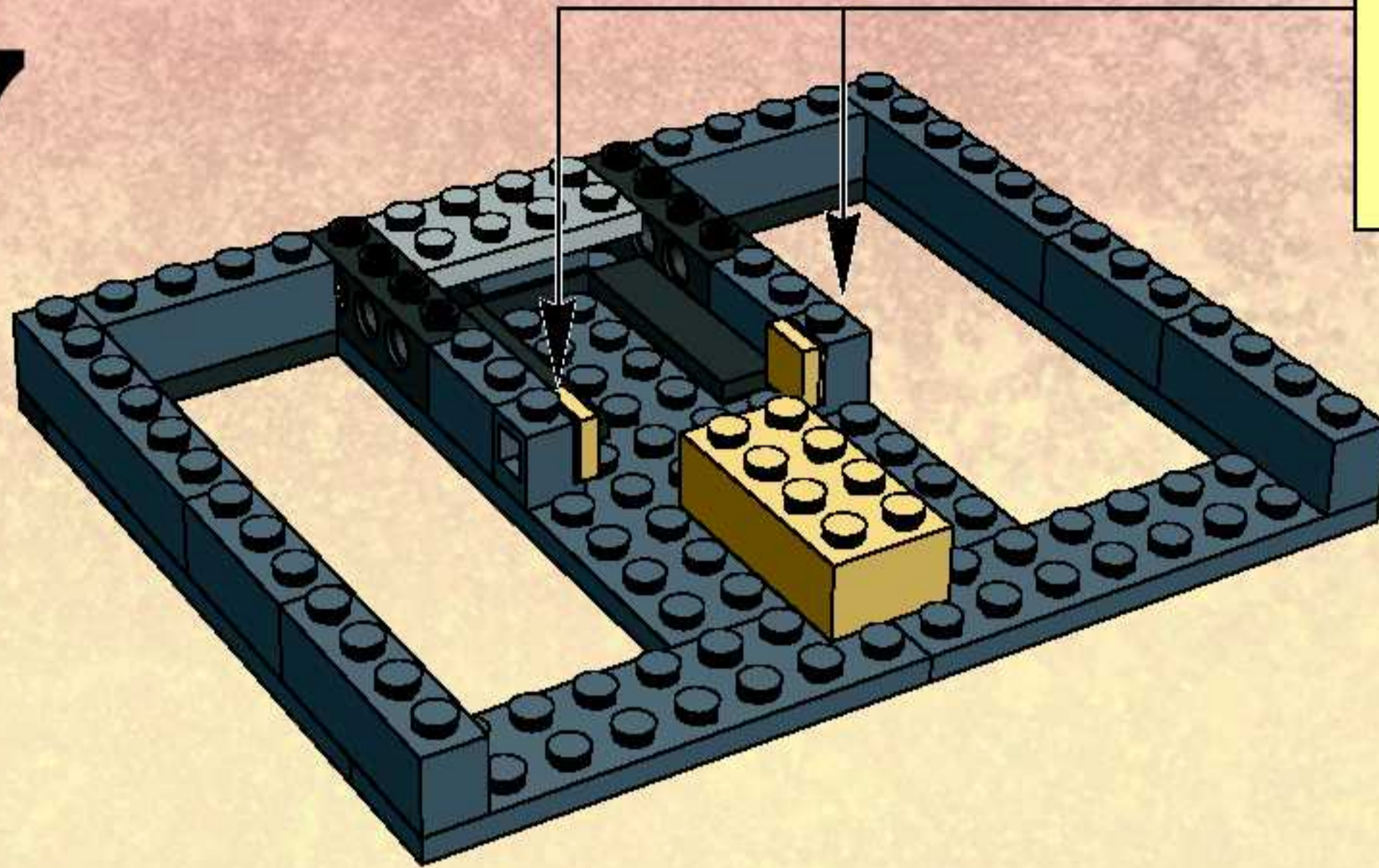

8

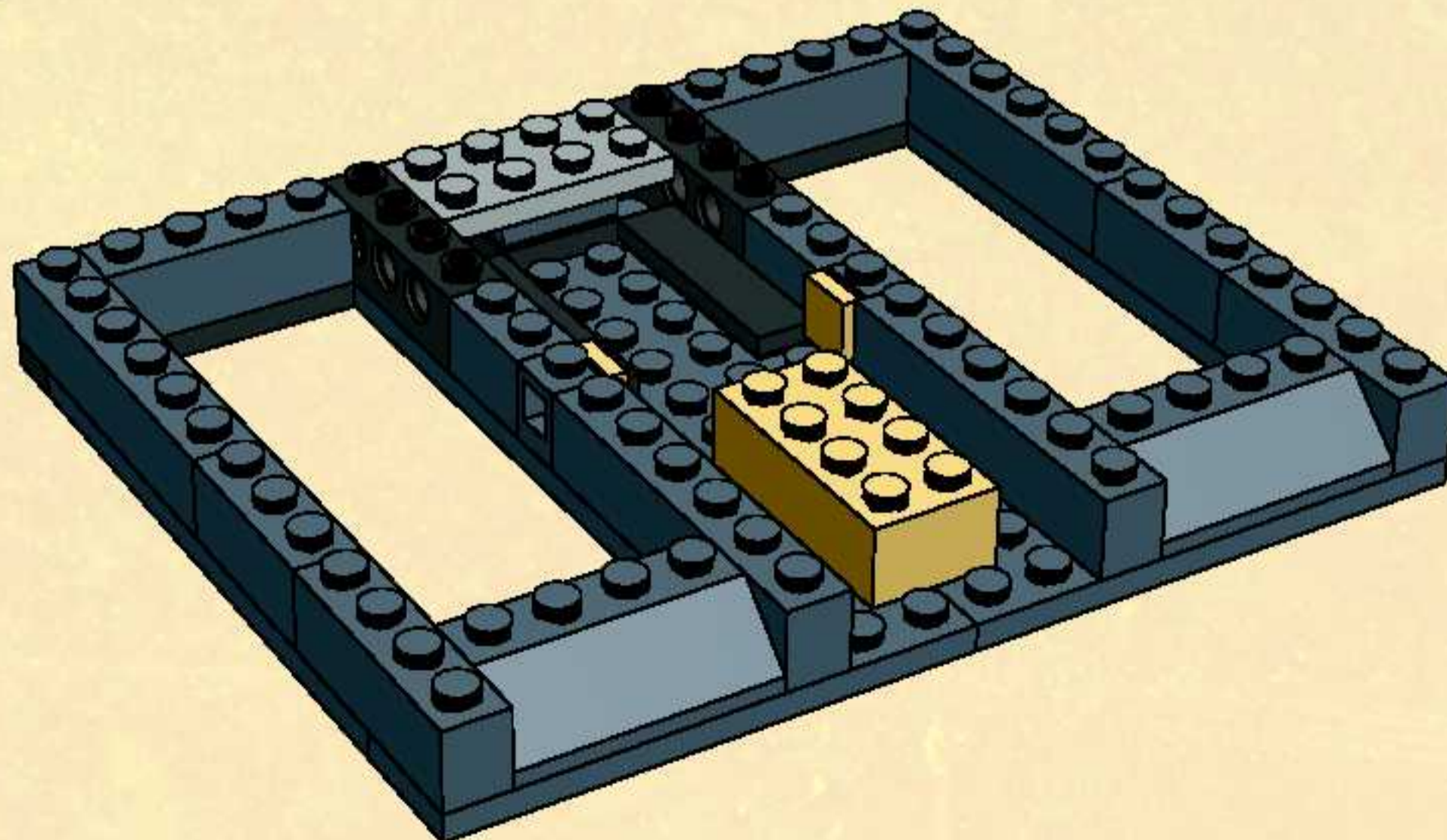

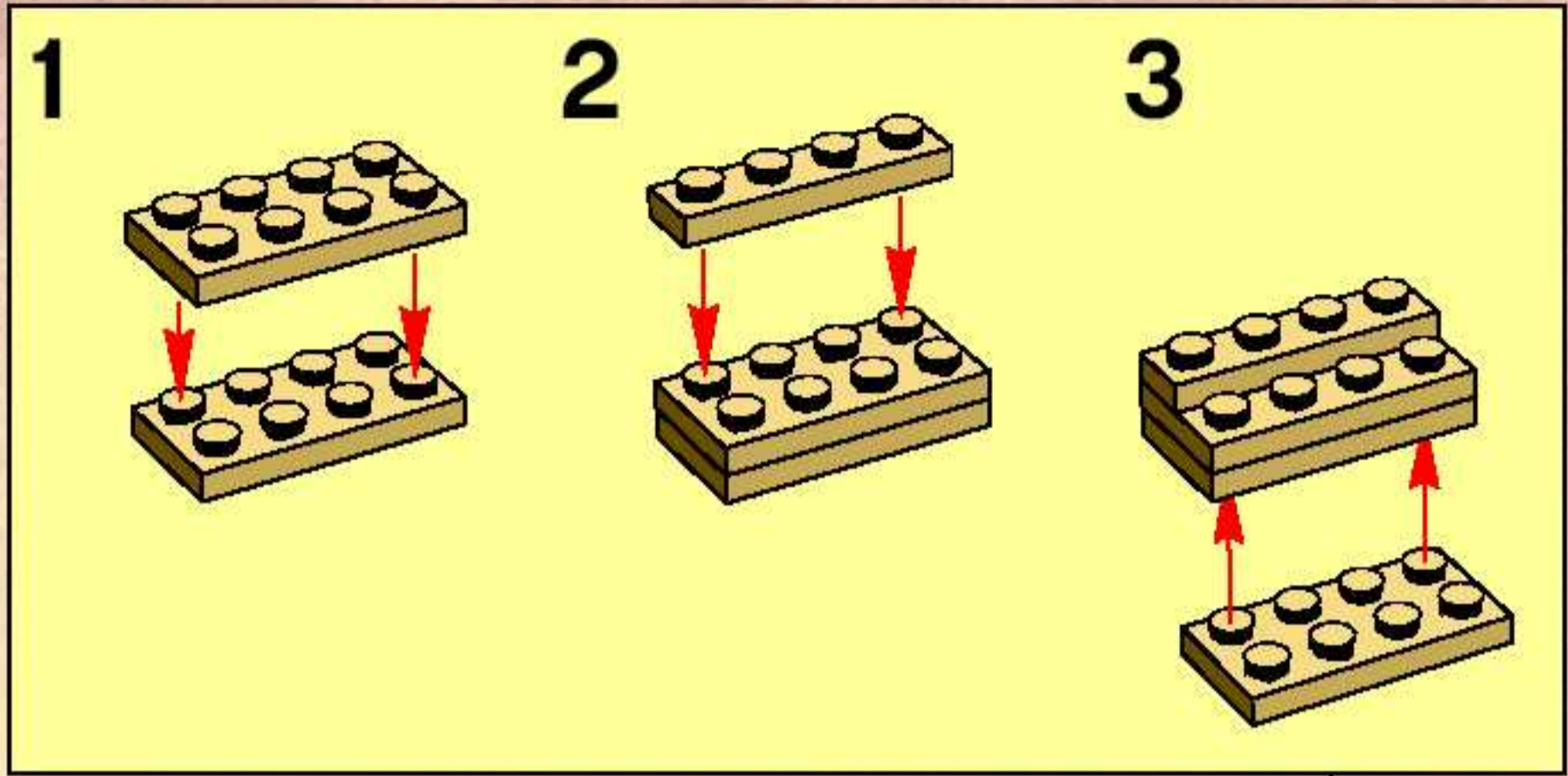

9

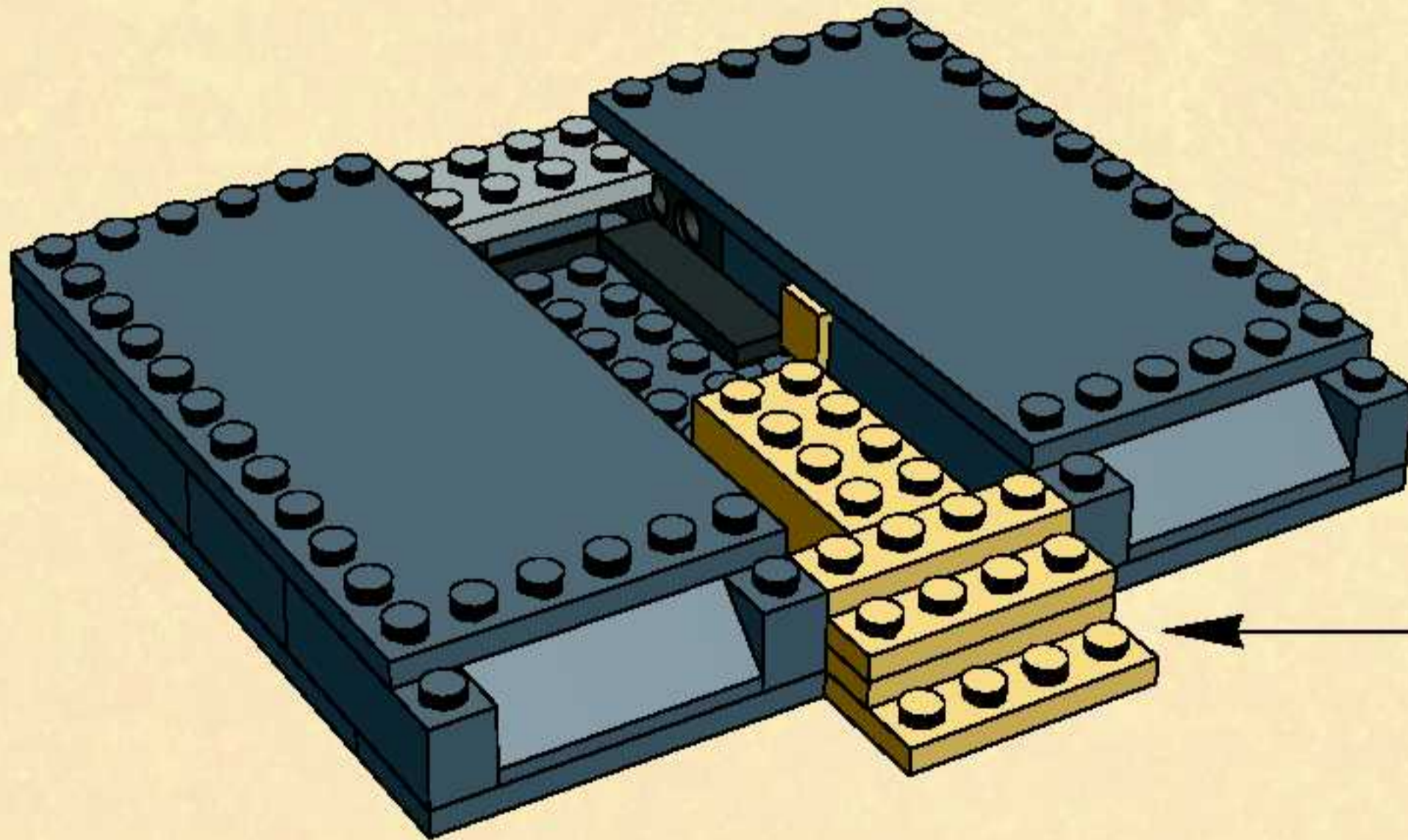

10

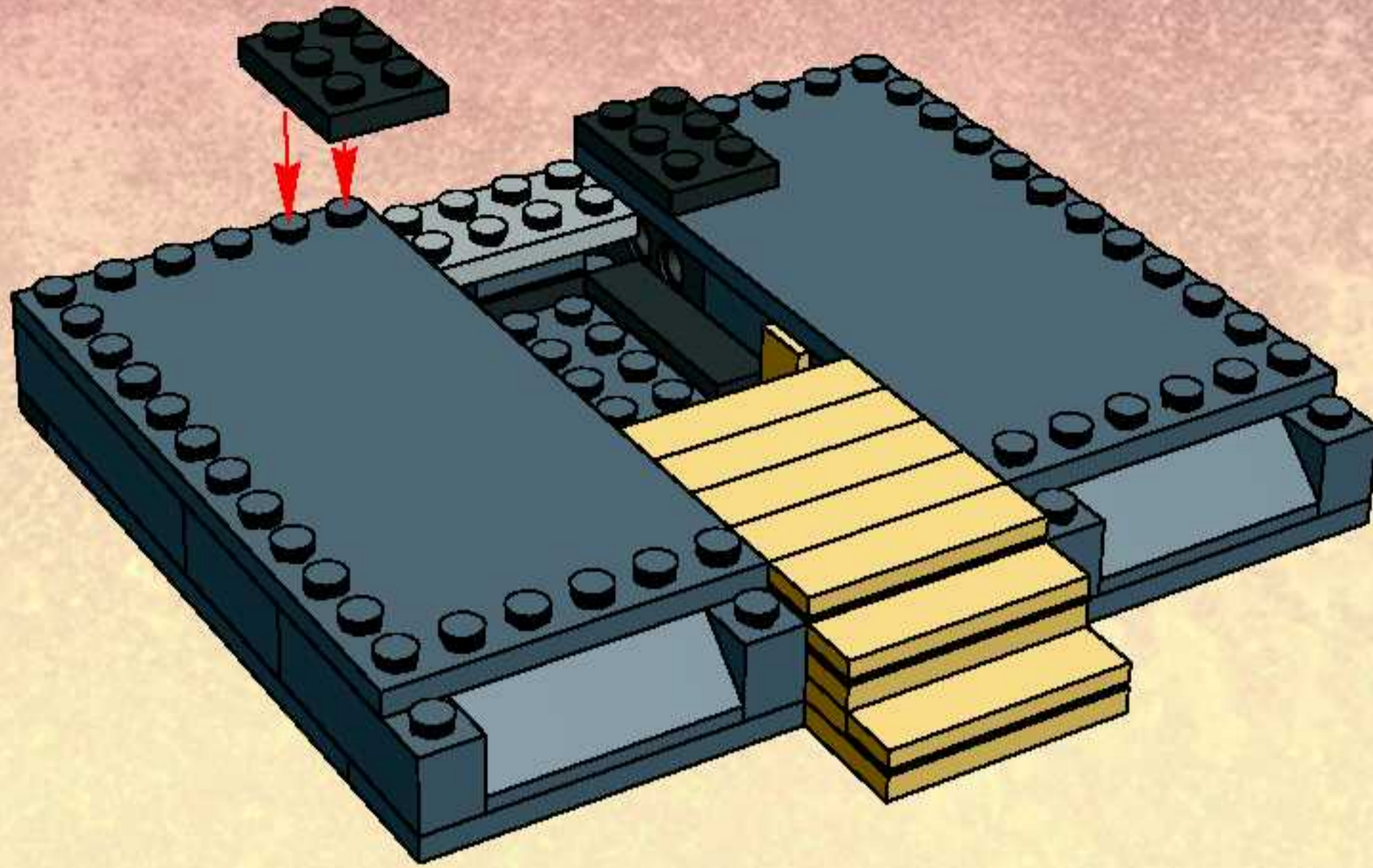

11

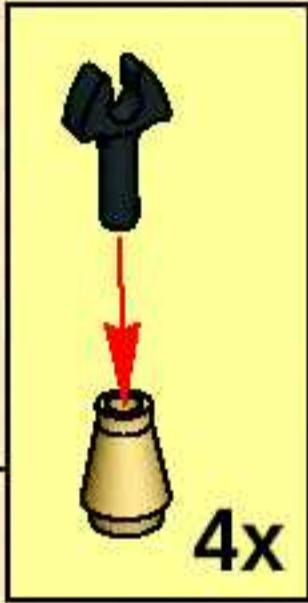
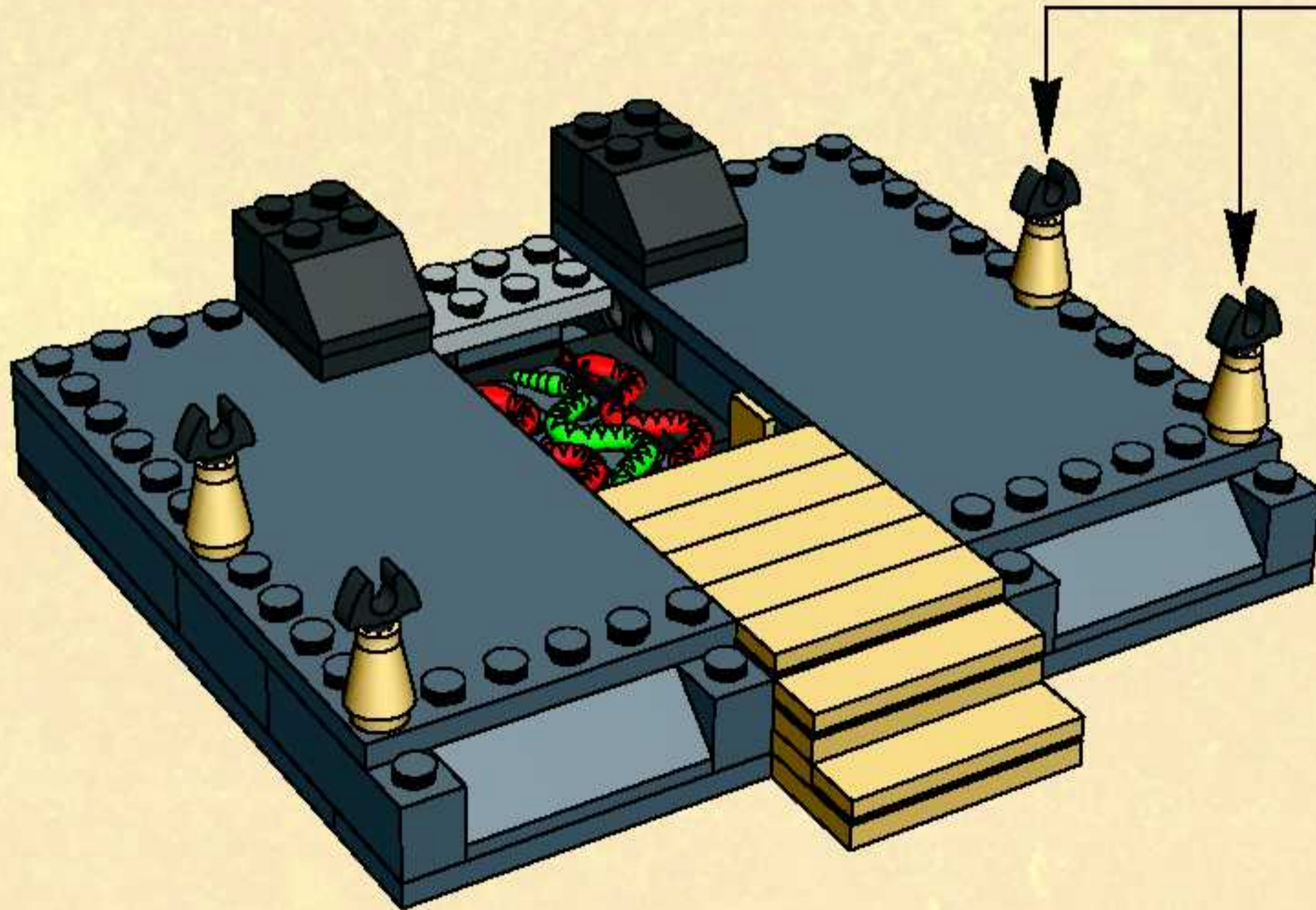



1

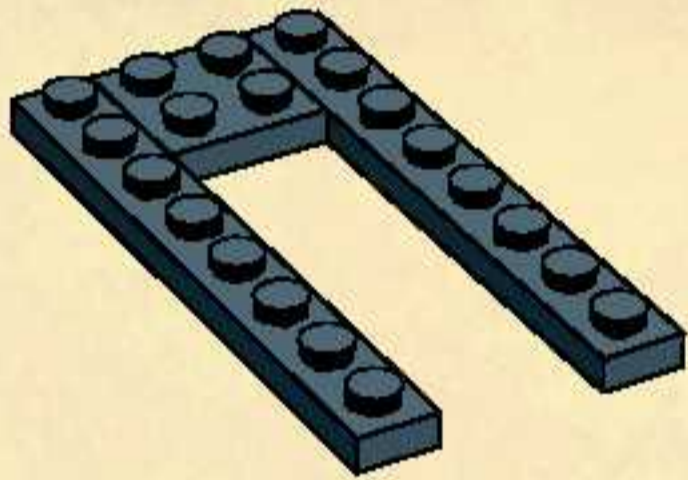

2

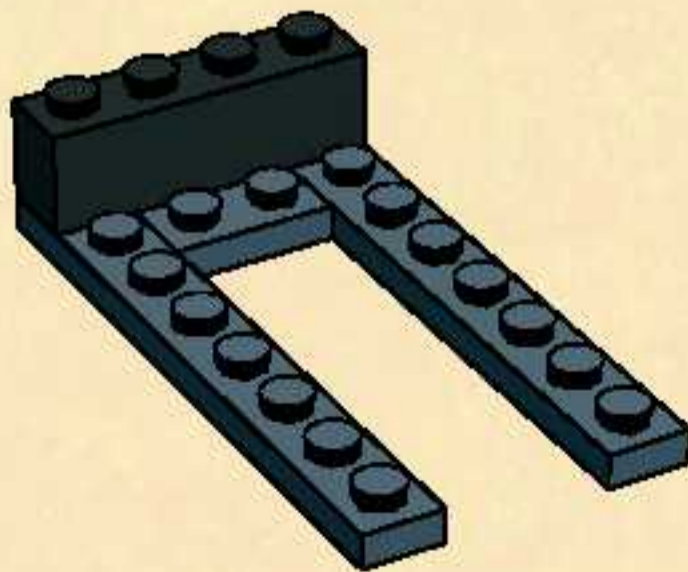

3

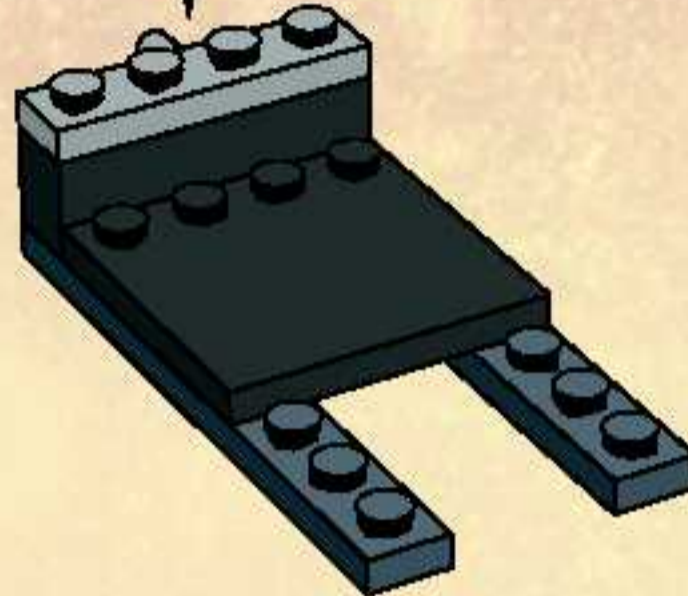
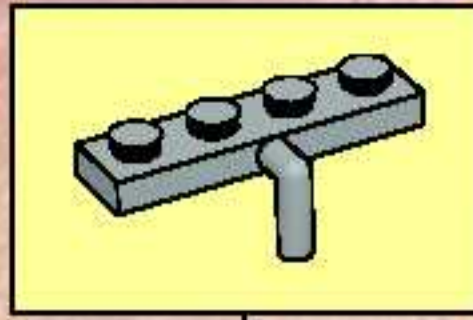

4

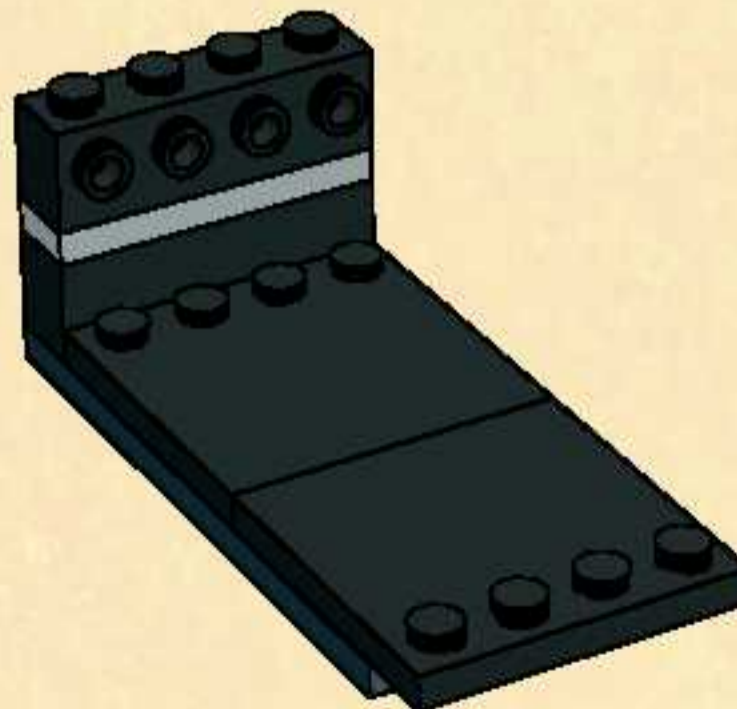

5

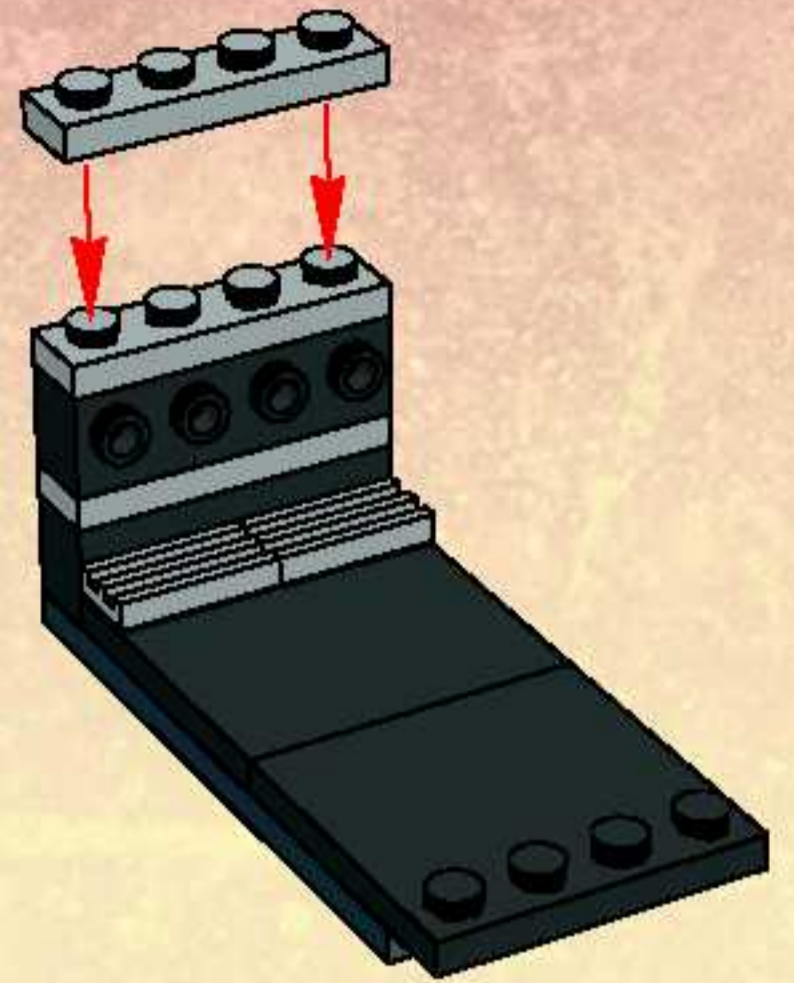

6

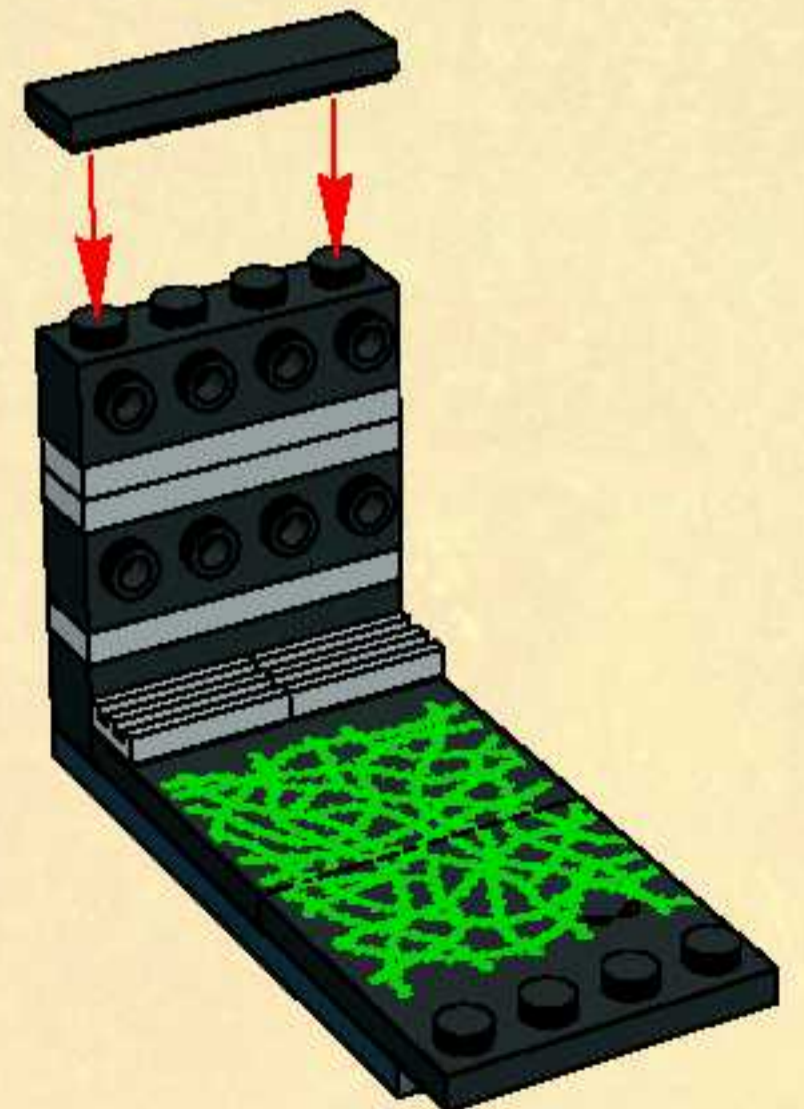

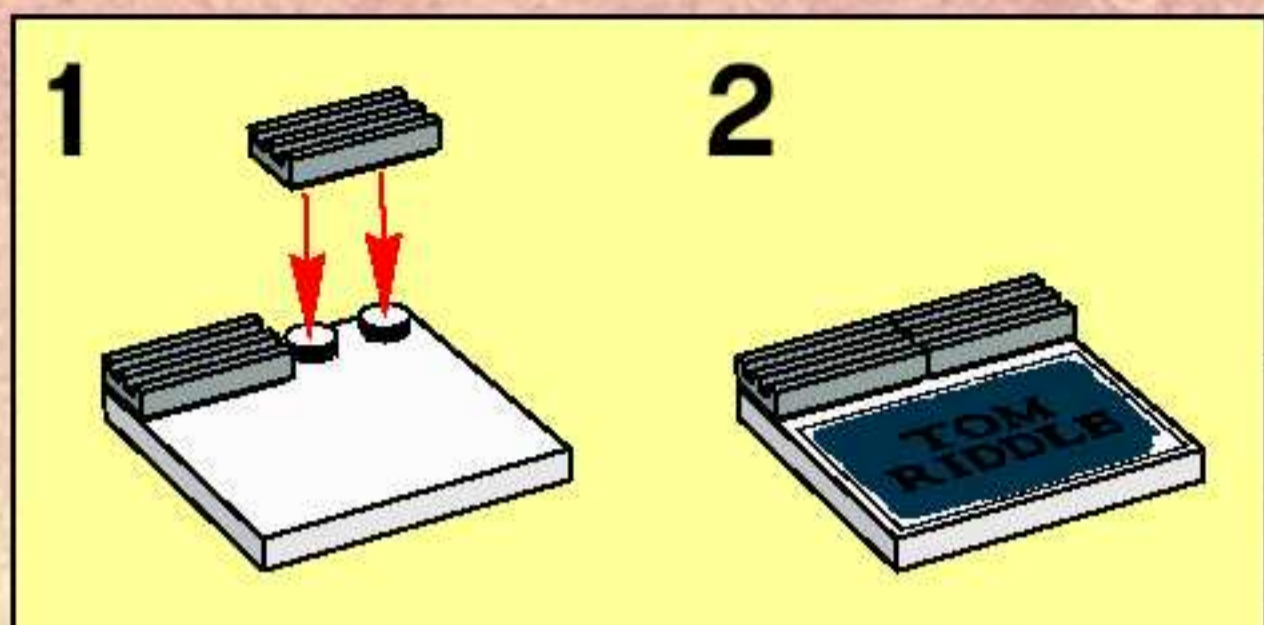

7

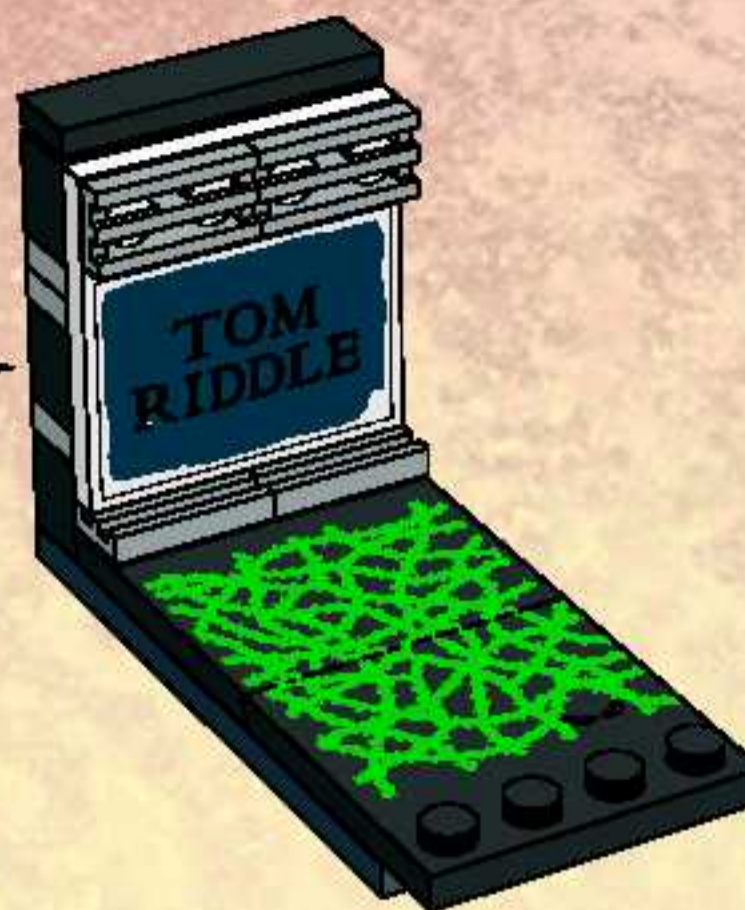

12

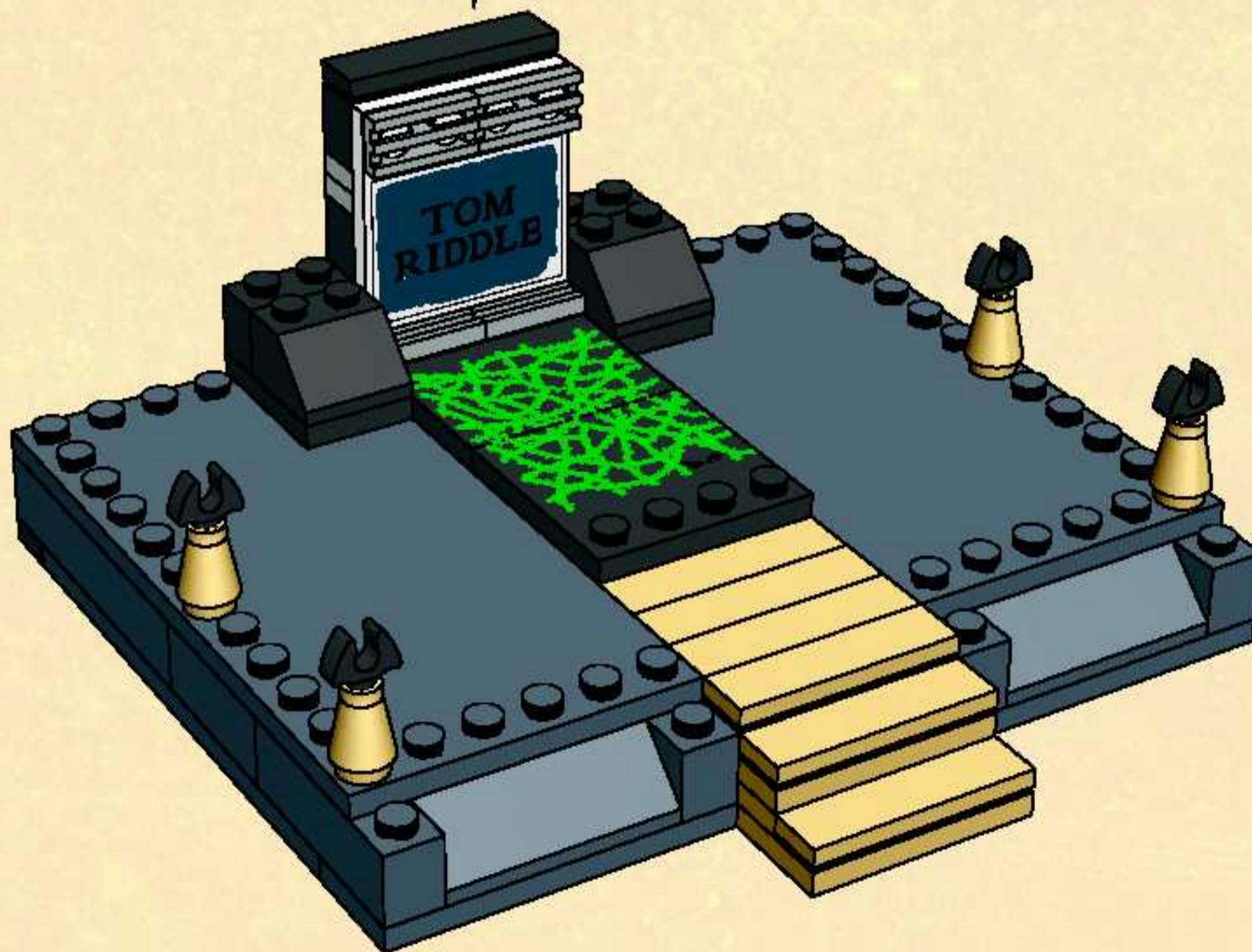

13

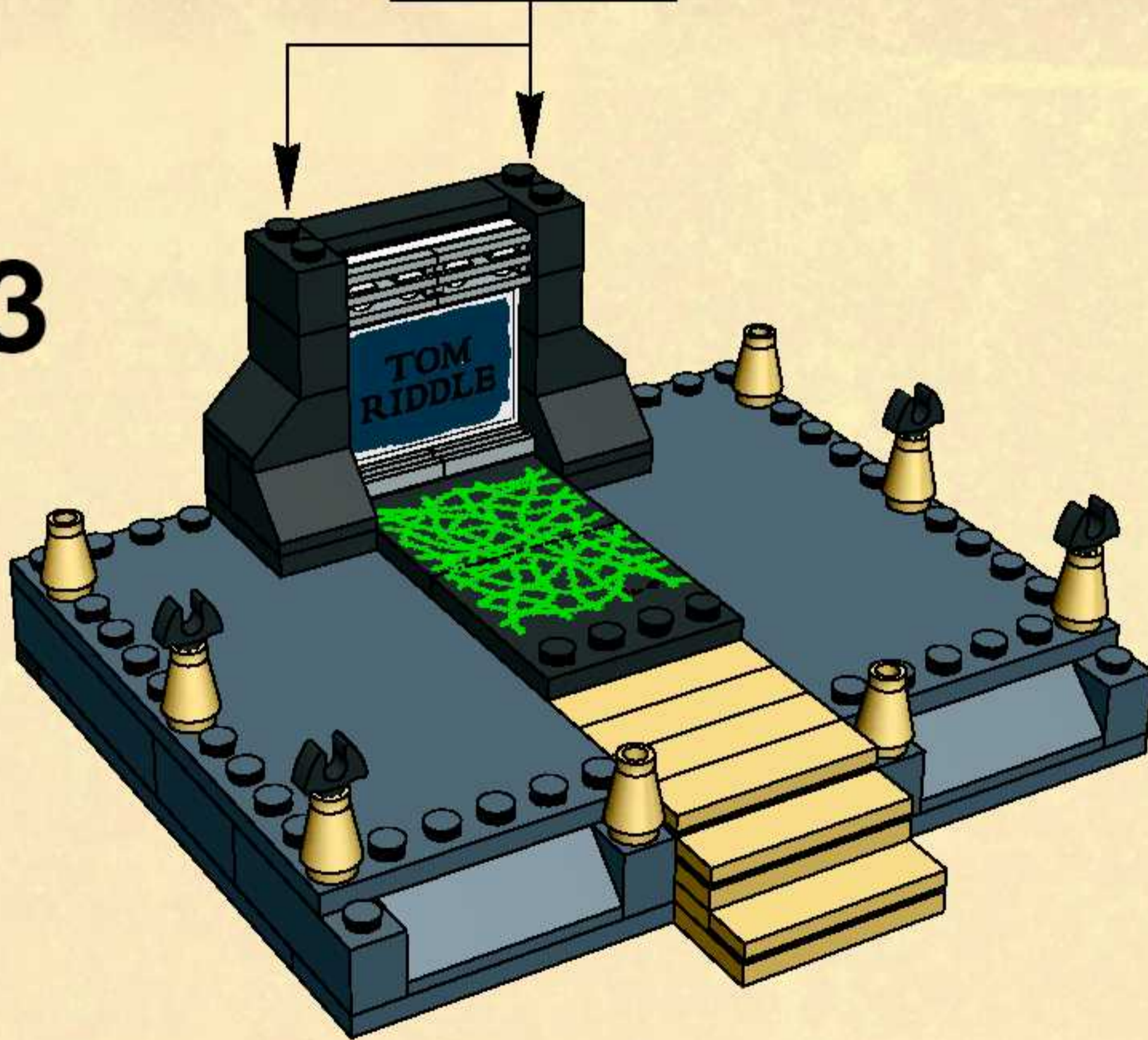
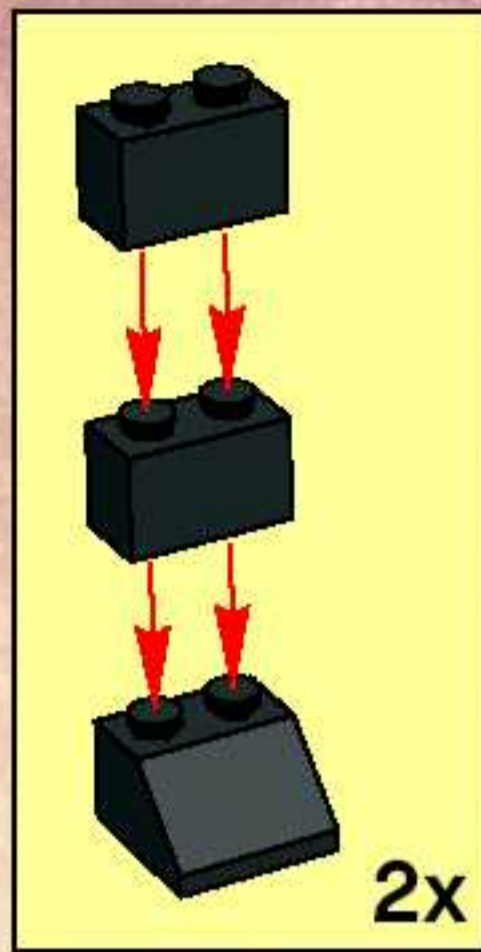

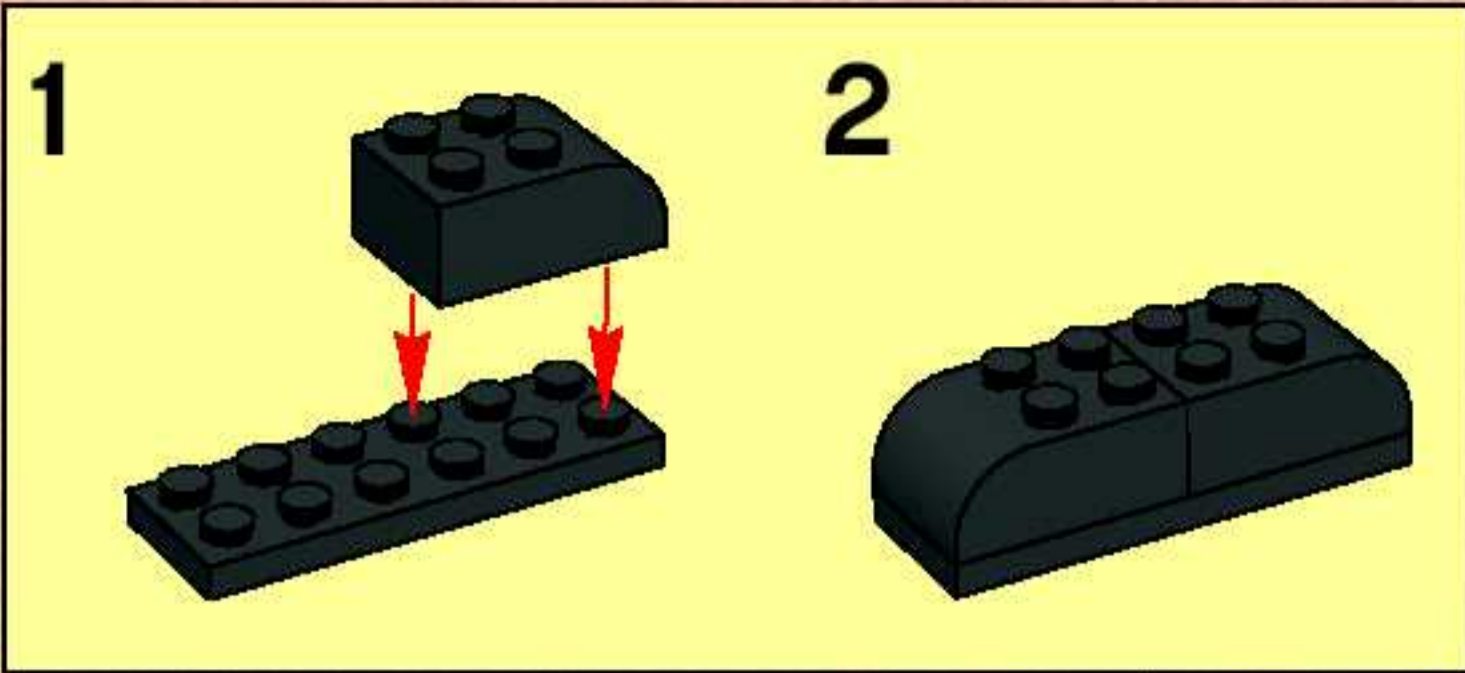

14

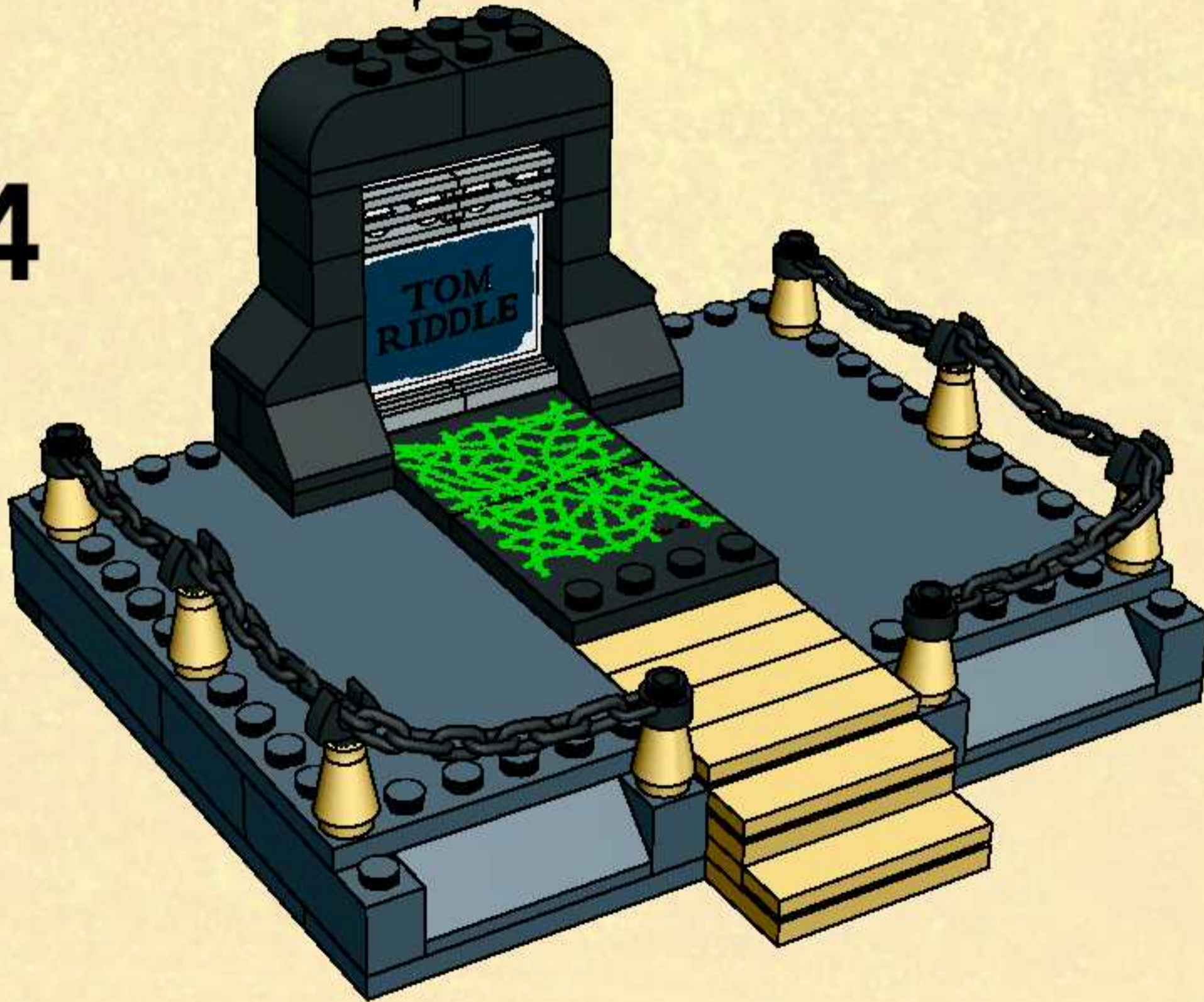

15

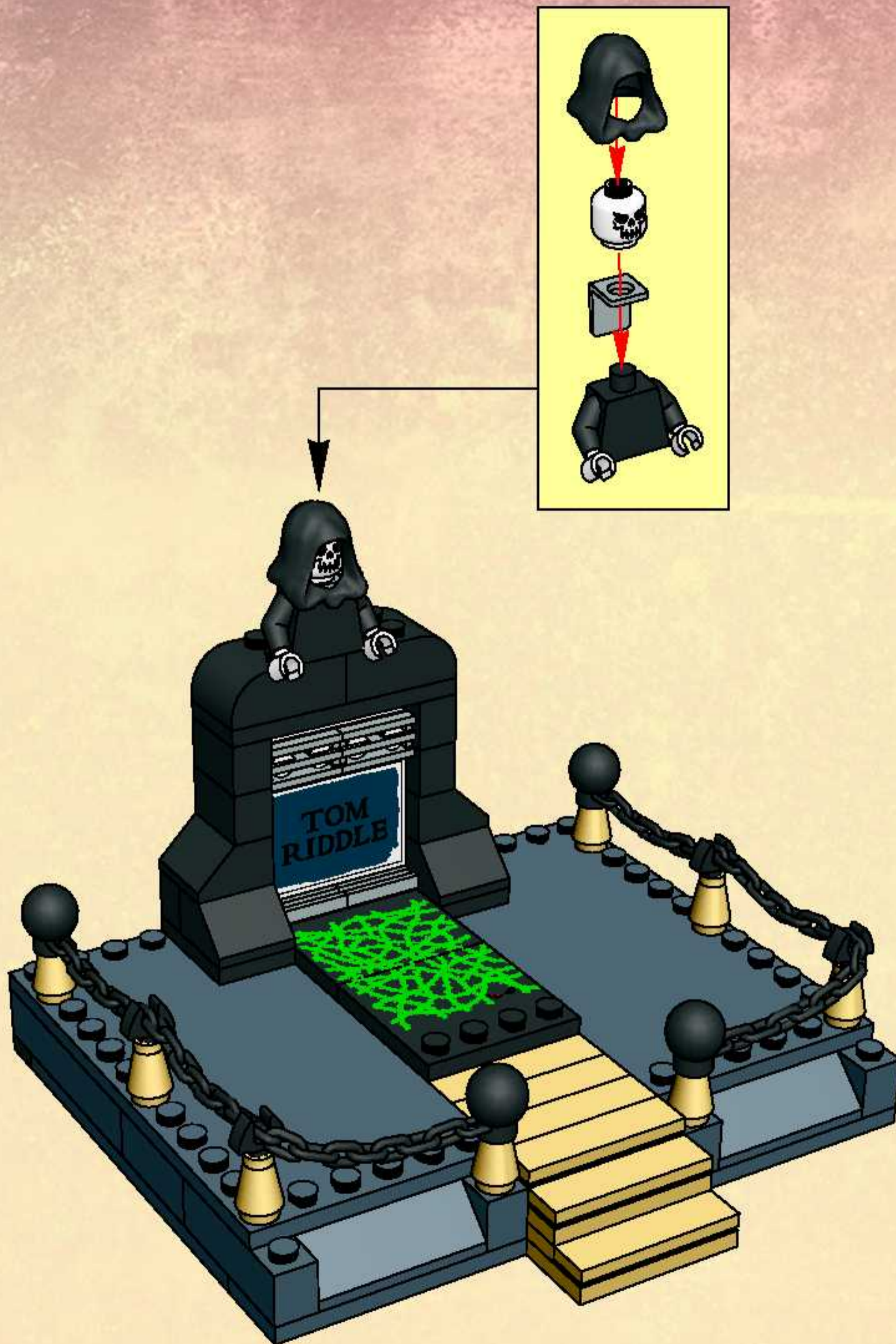

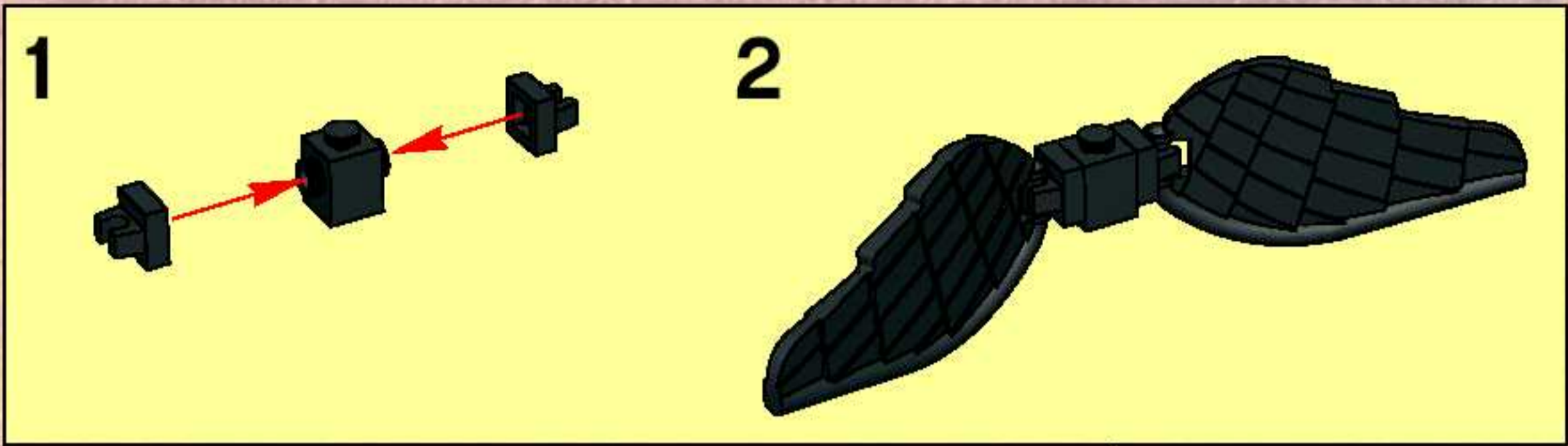

16



4

4

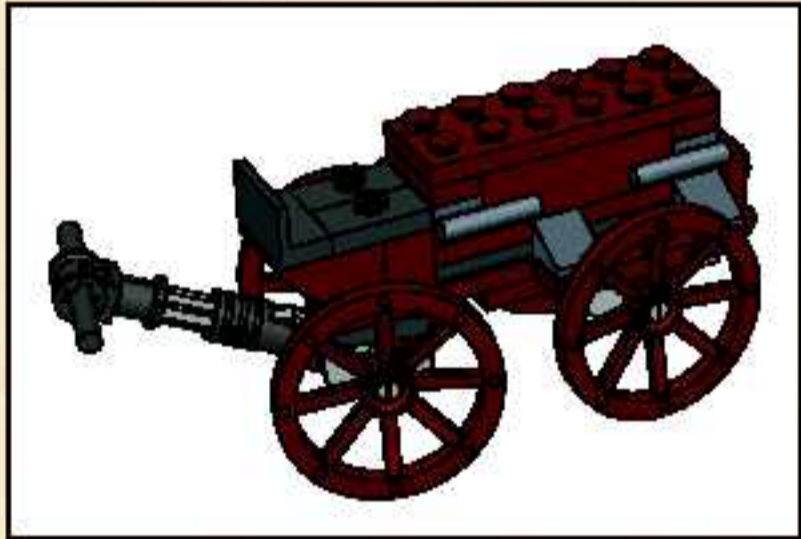

1

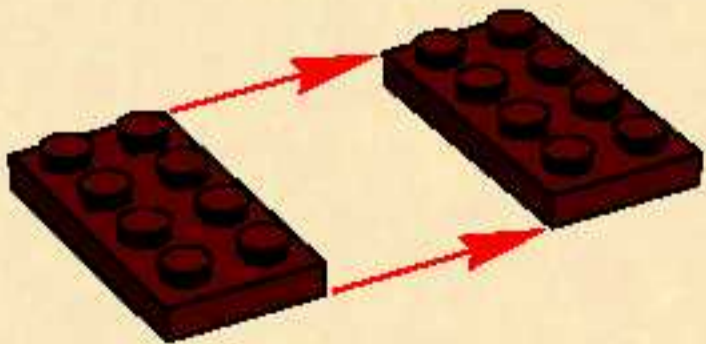

2

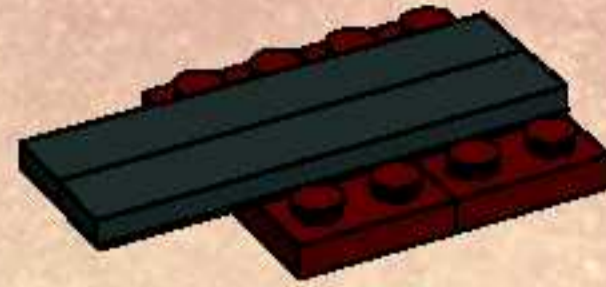

3

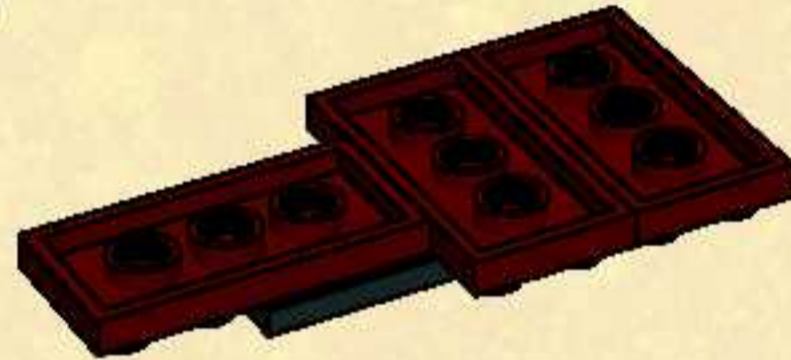

4

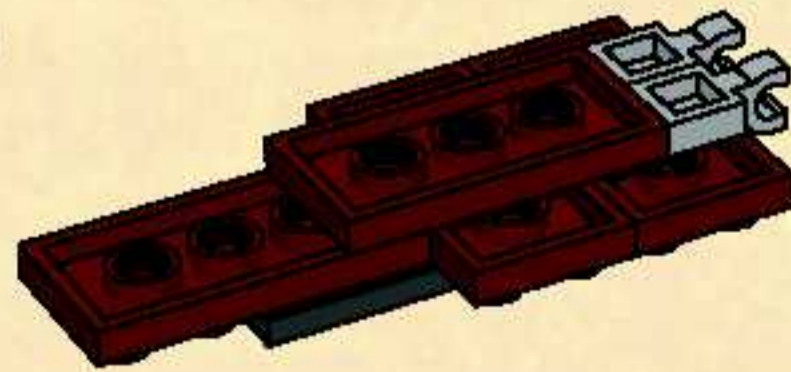

5

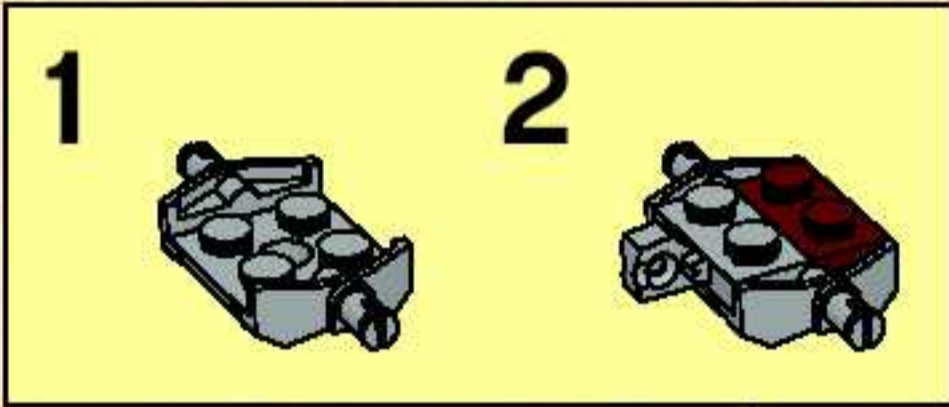
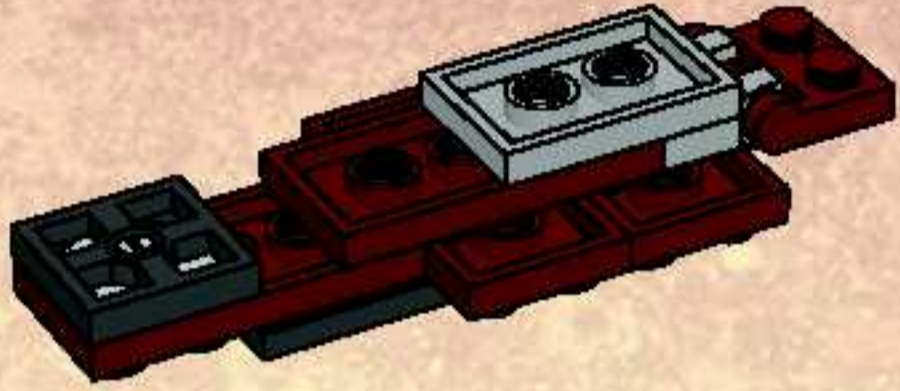

6

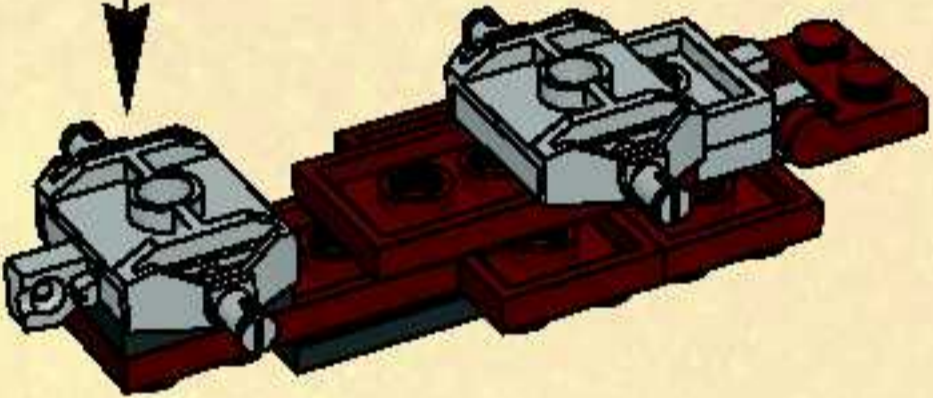

7

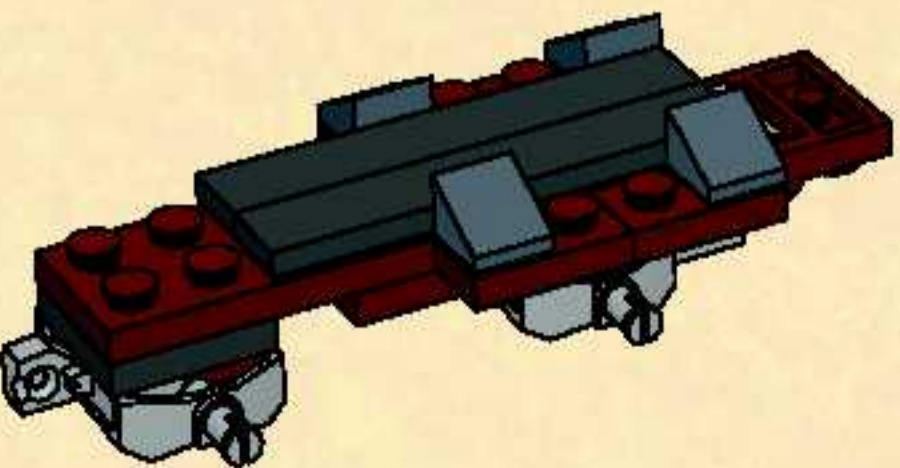

1

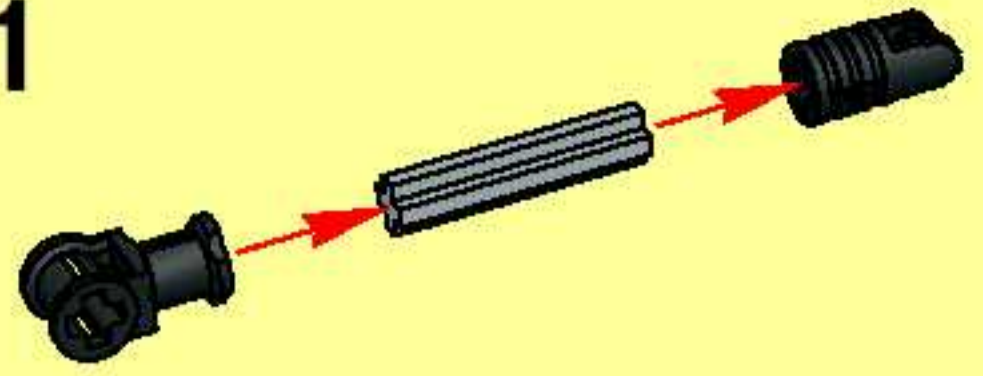

2



8

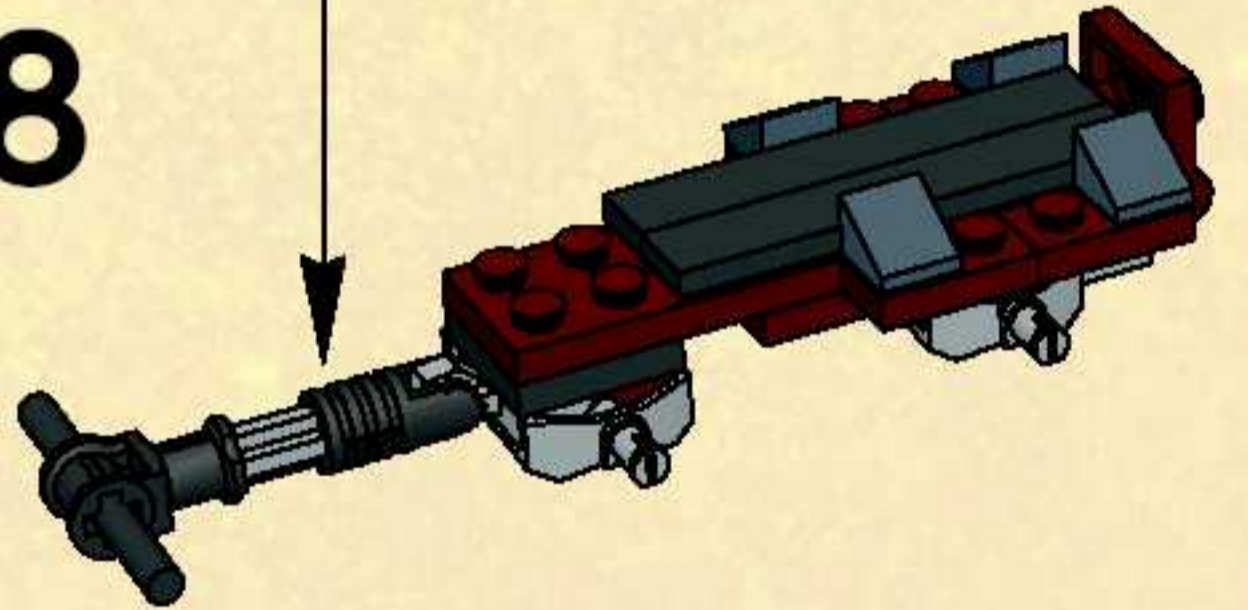

9

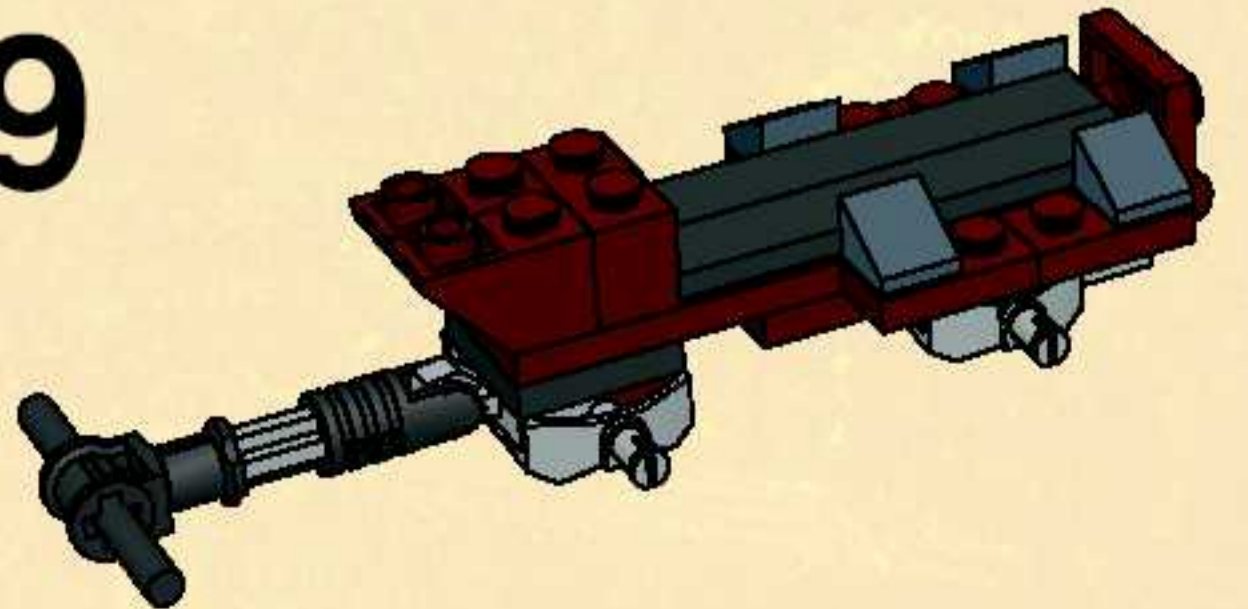

10

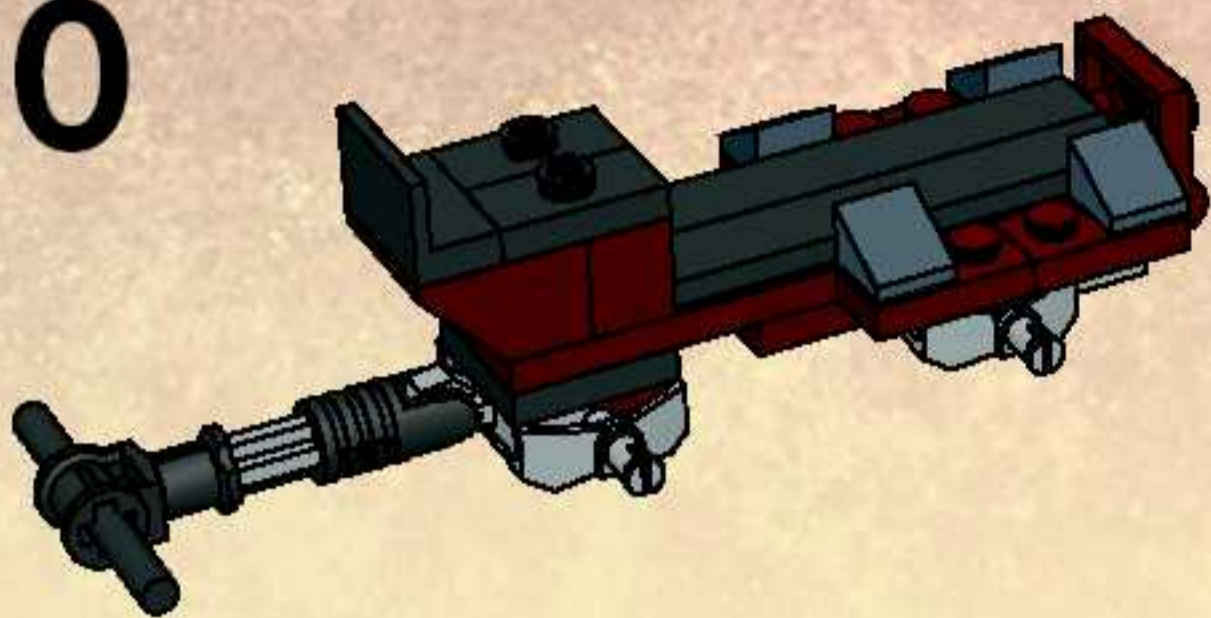

11

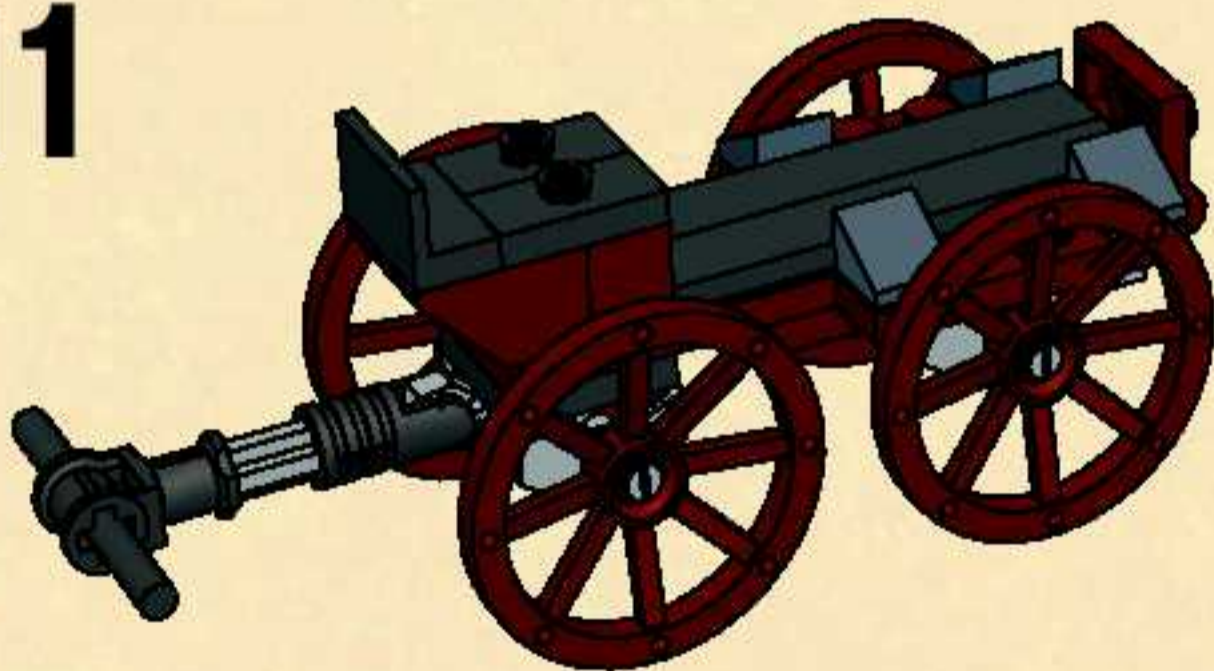

1

2

3

4

5

12

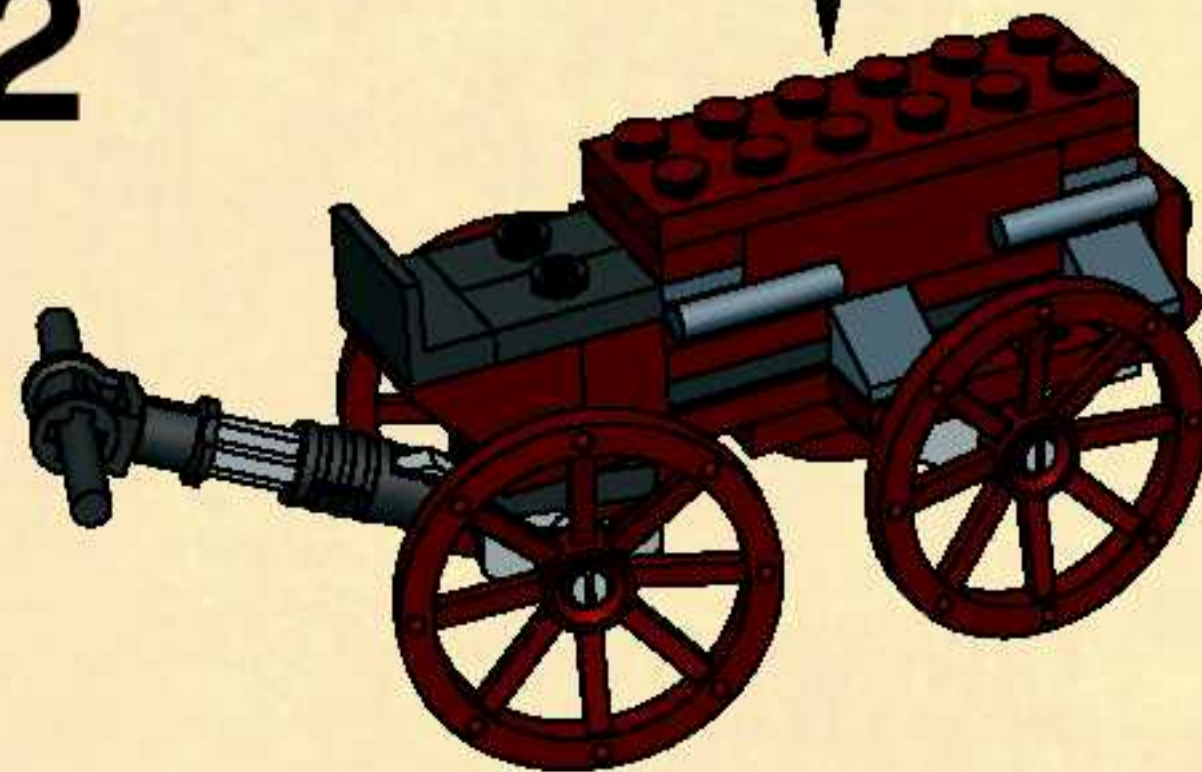

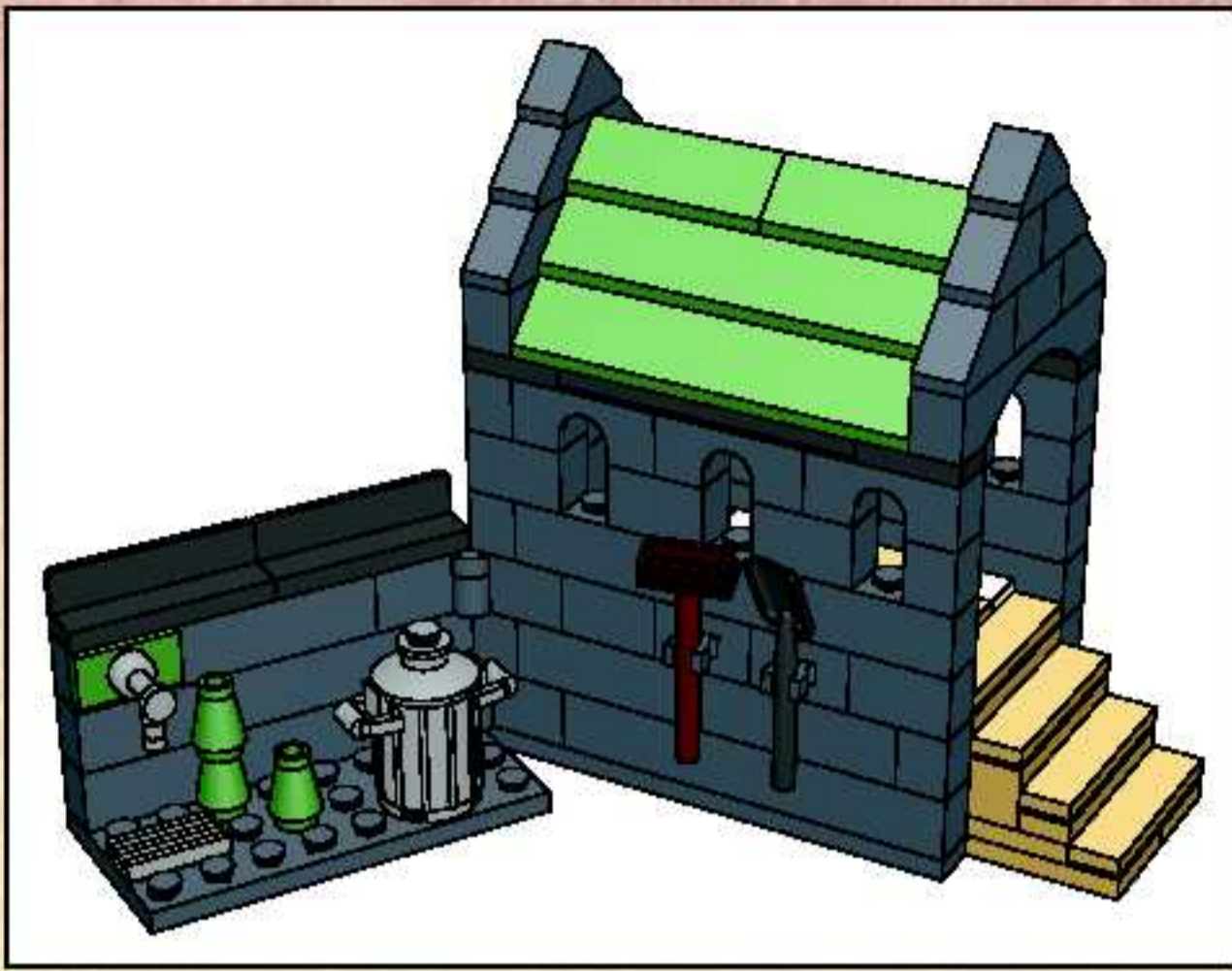

1

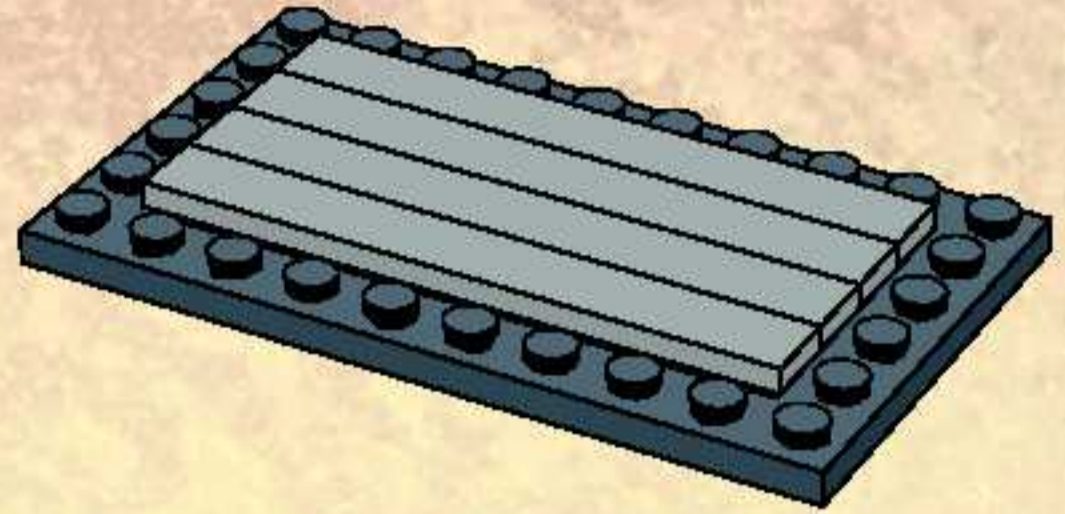

2

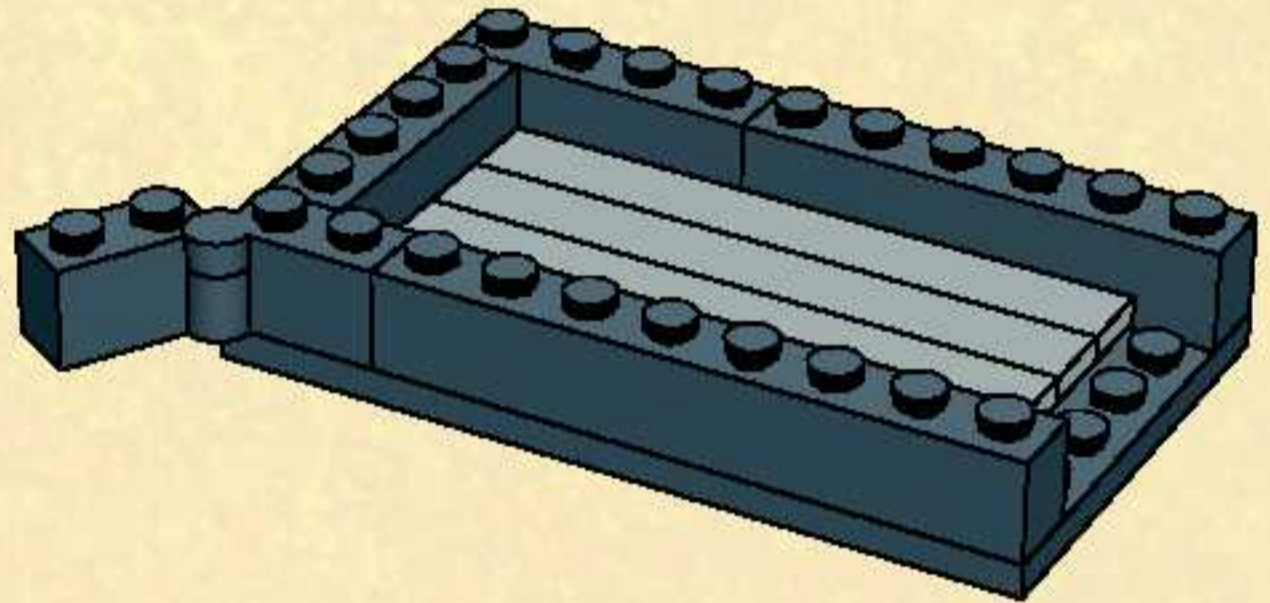
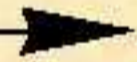
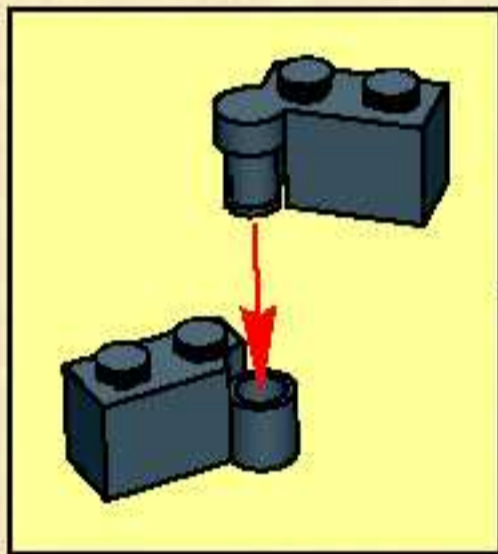

3

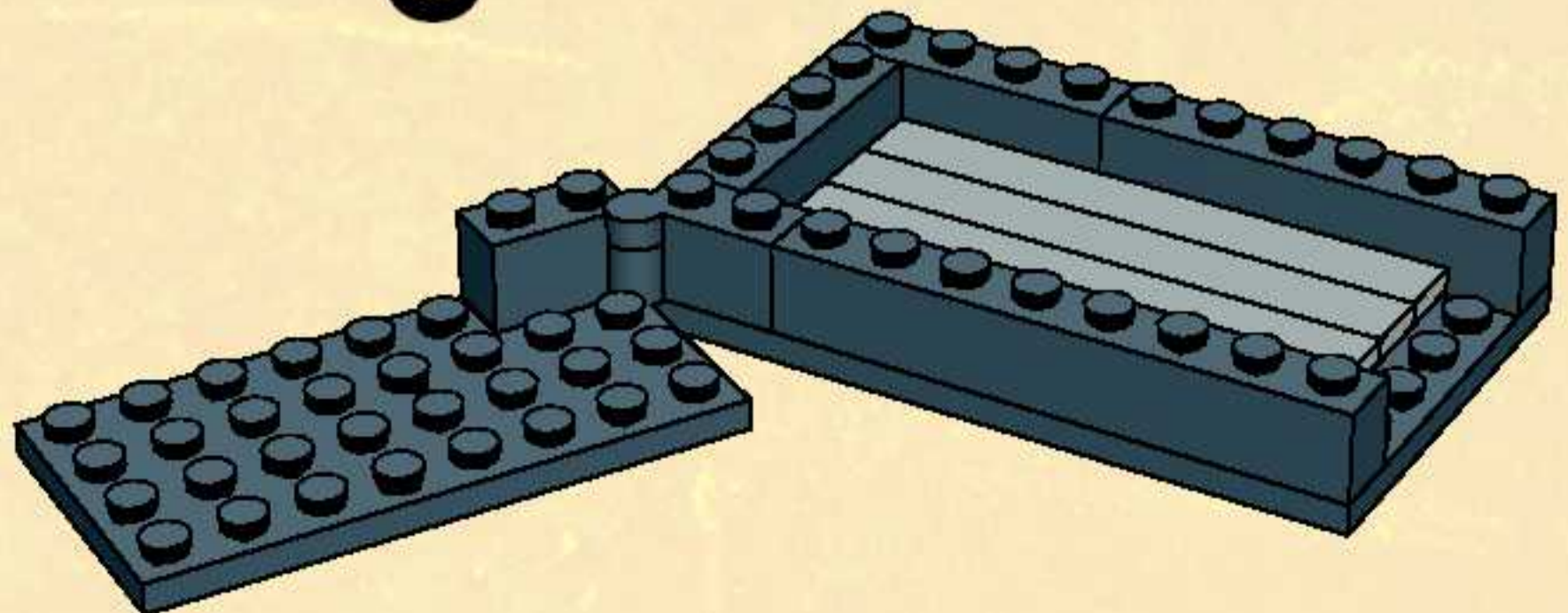

4

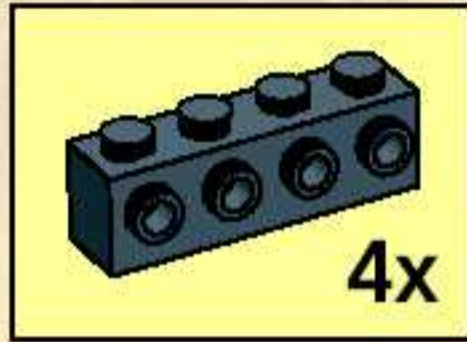
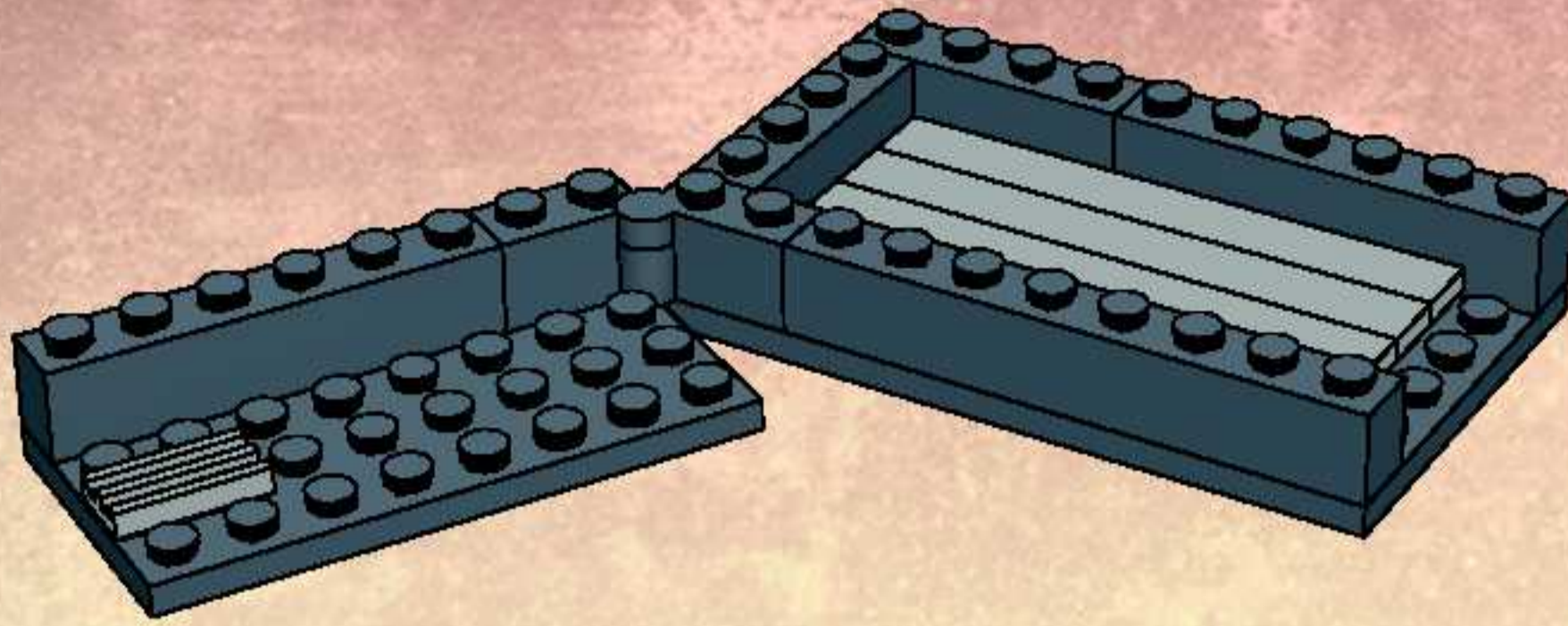

5

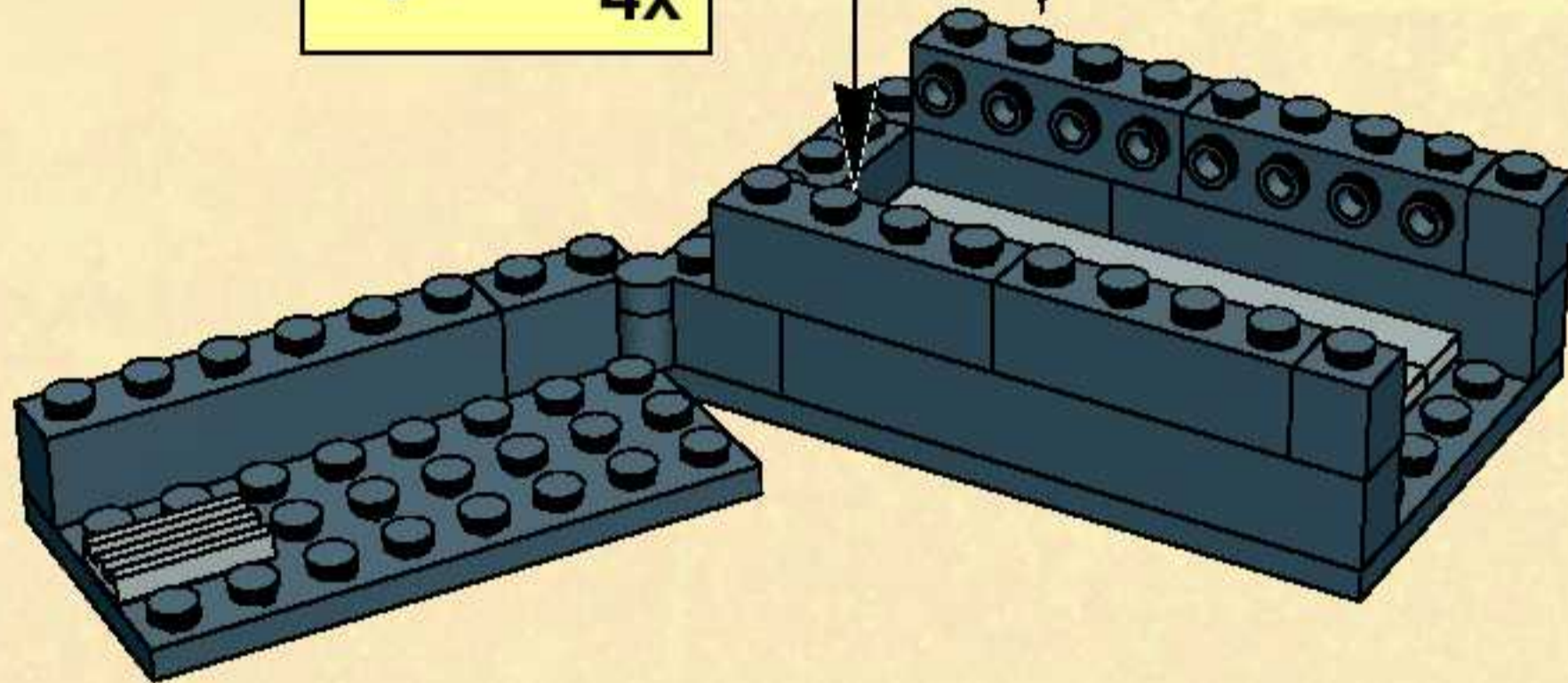

6

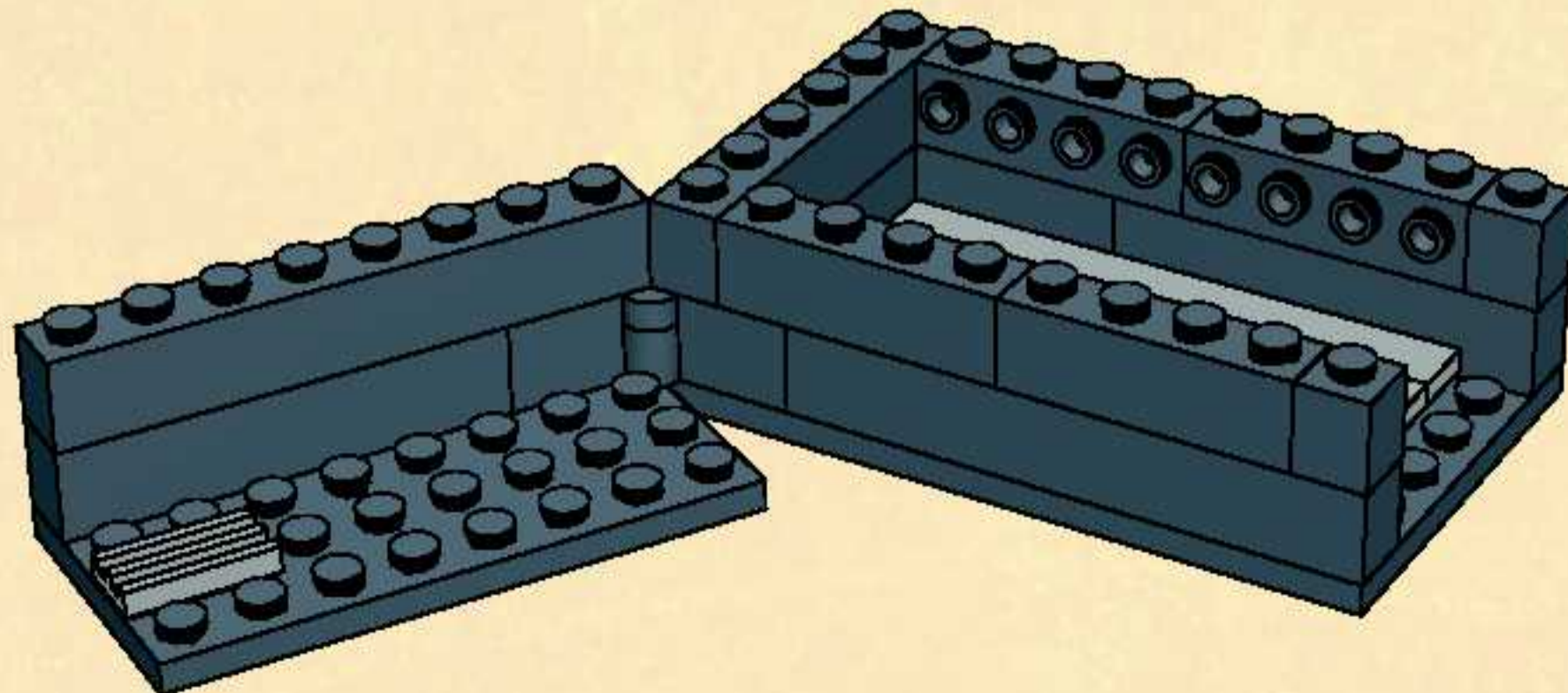

7

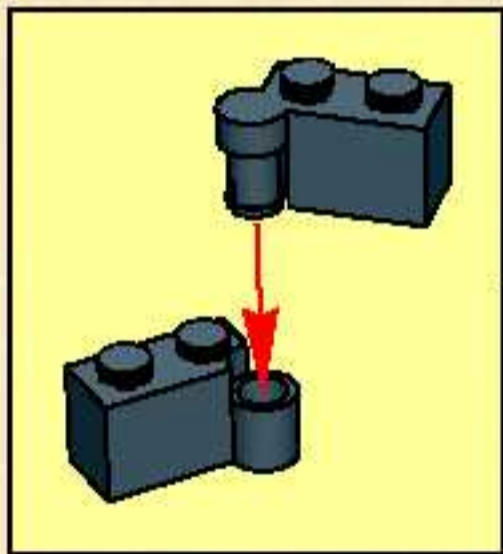
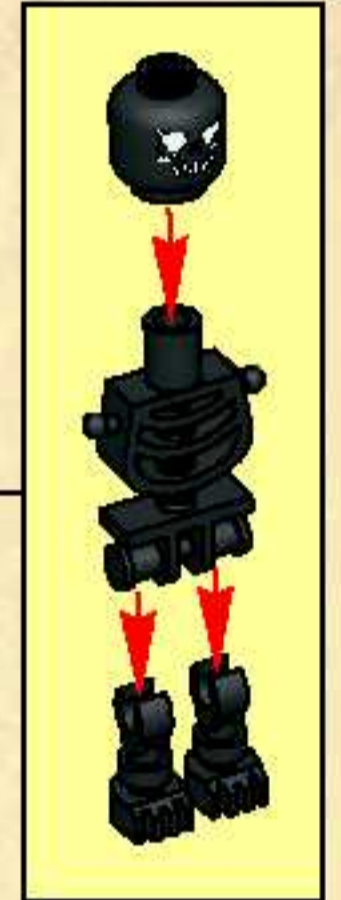
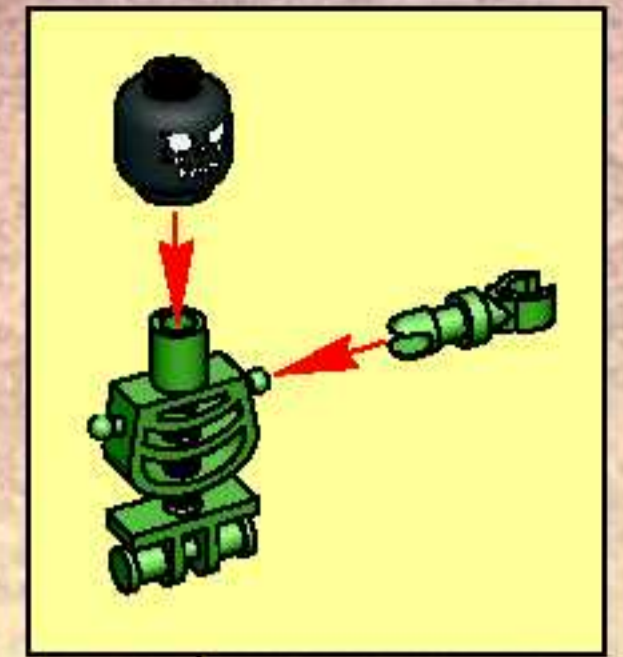
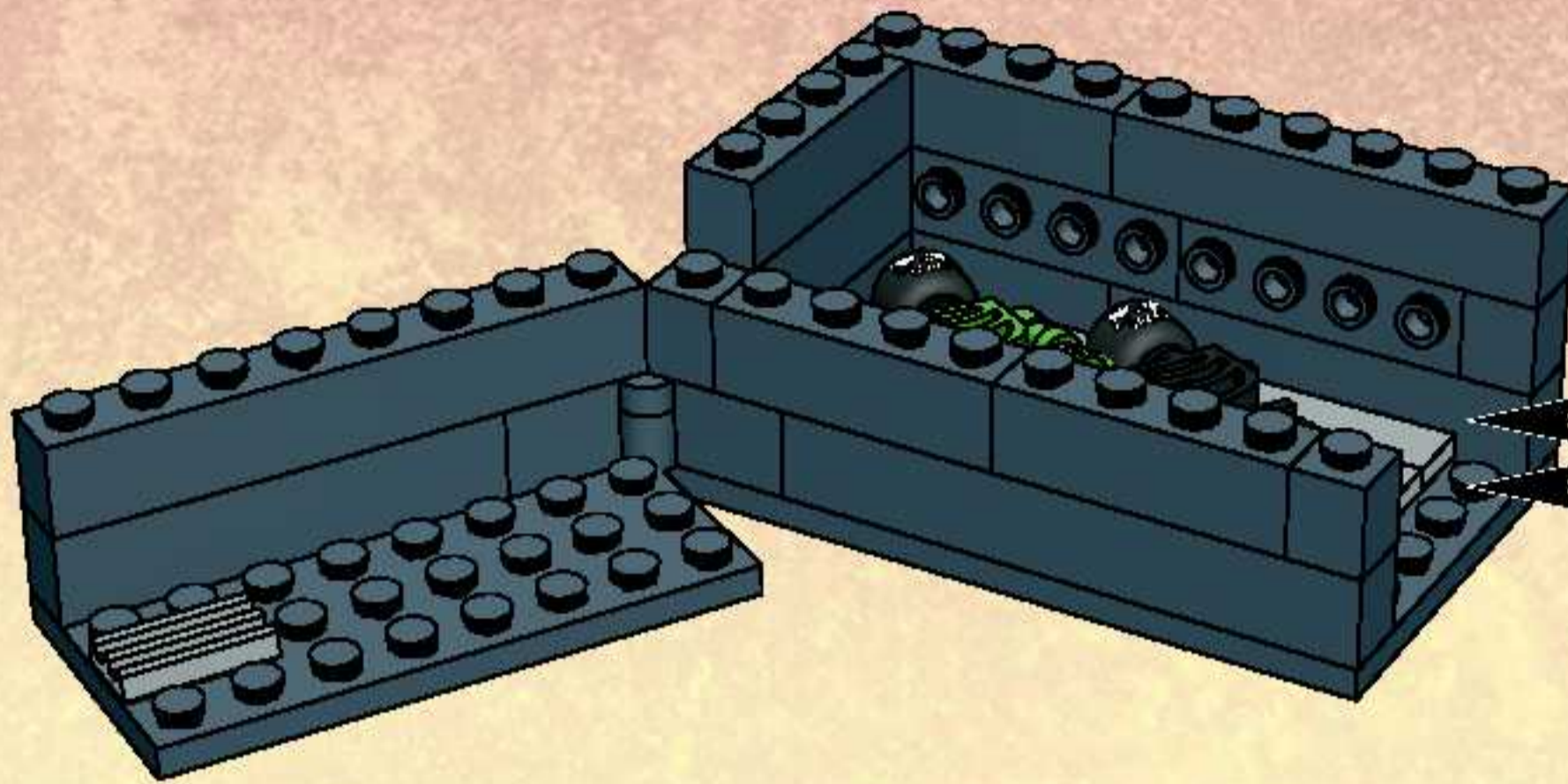

8

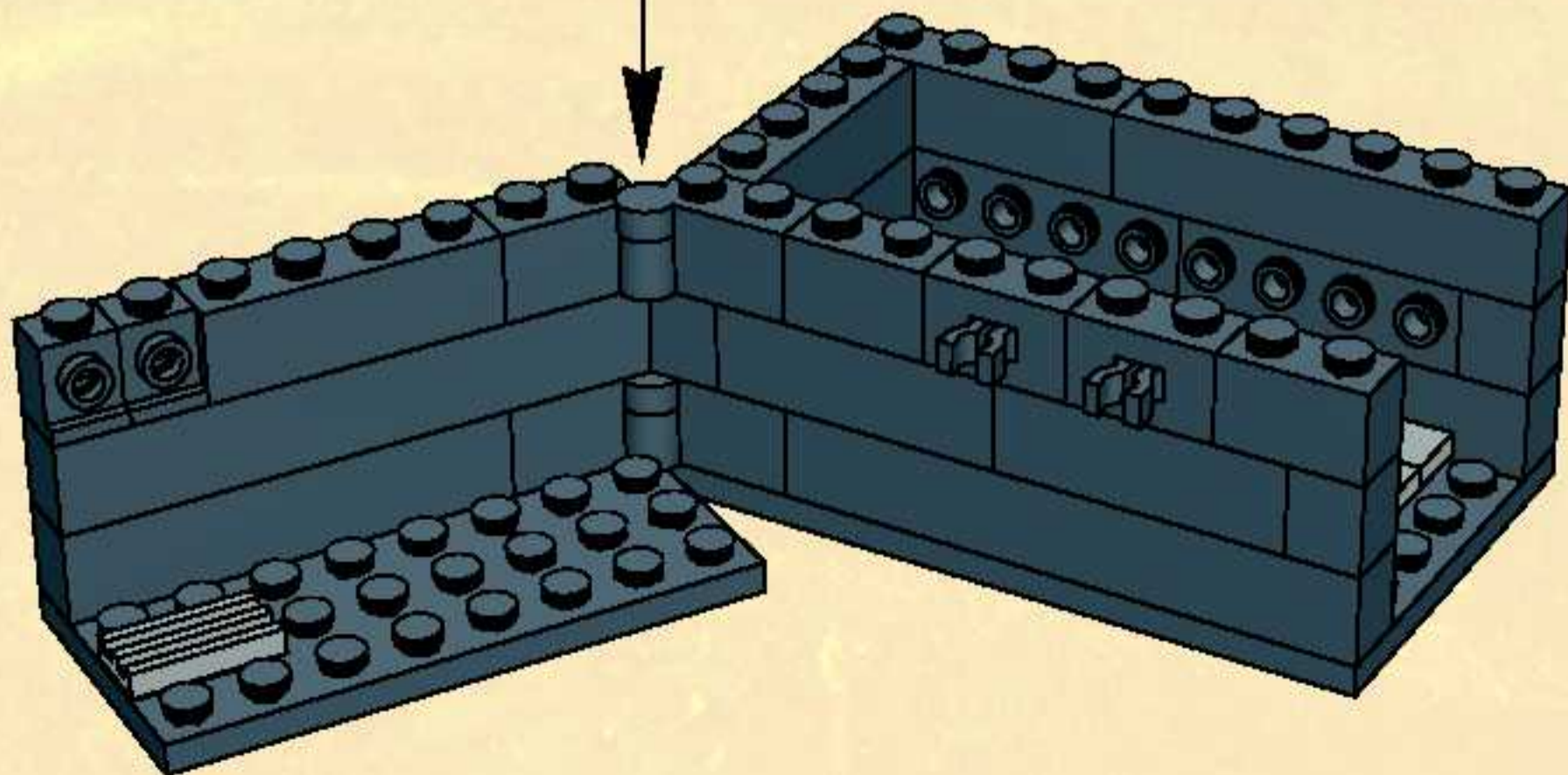

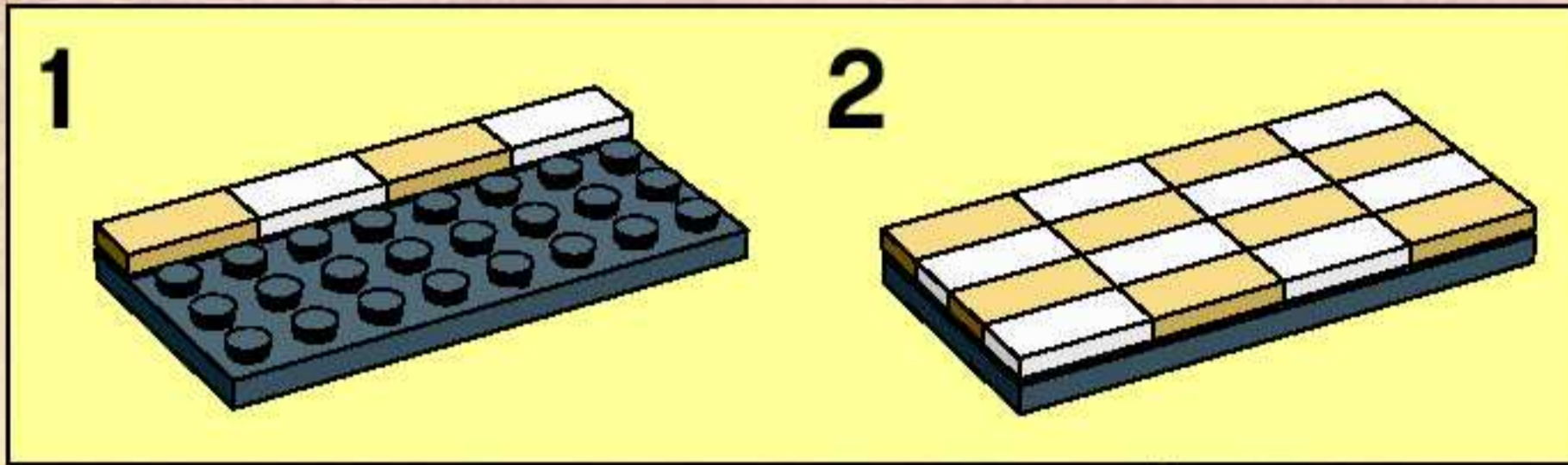

9

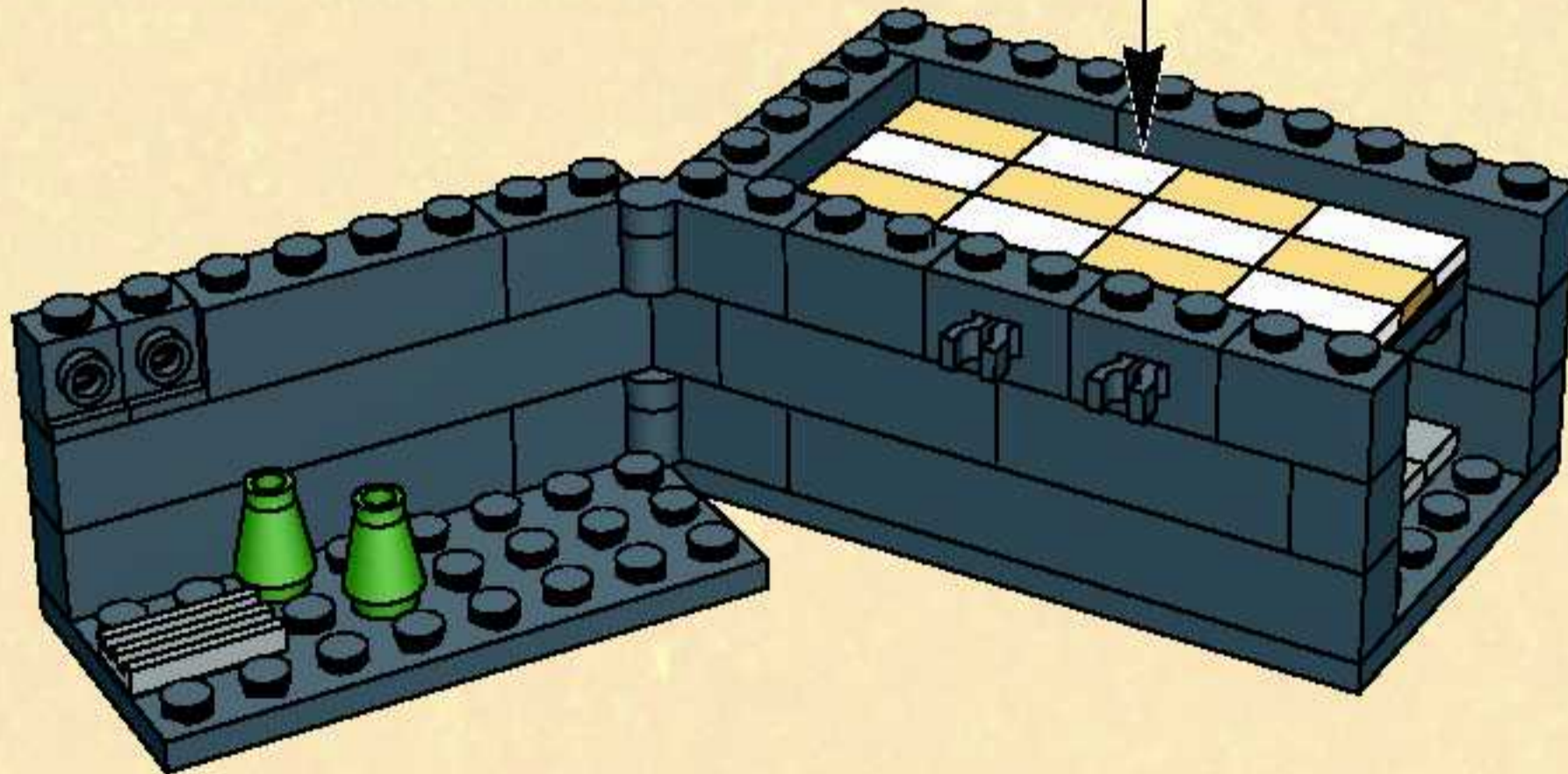

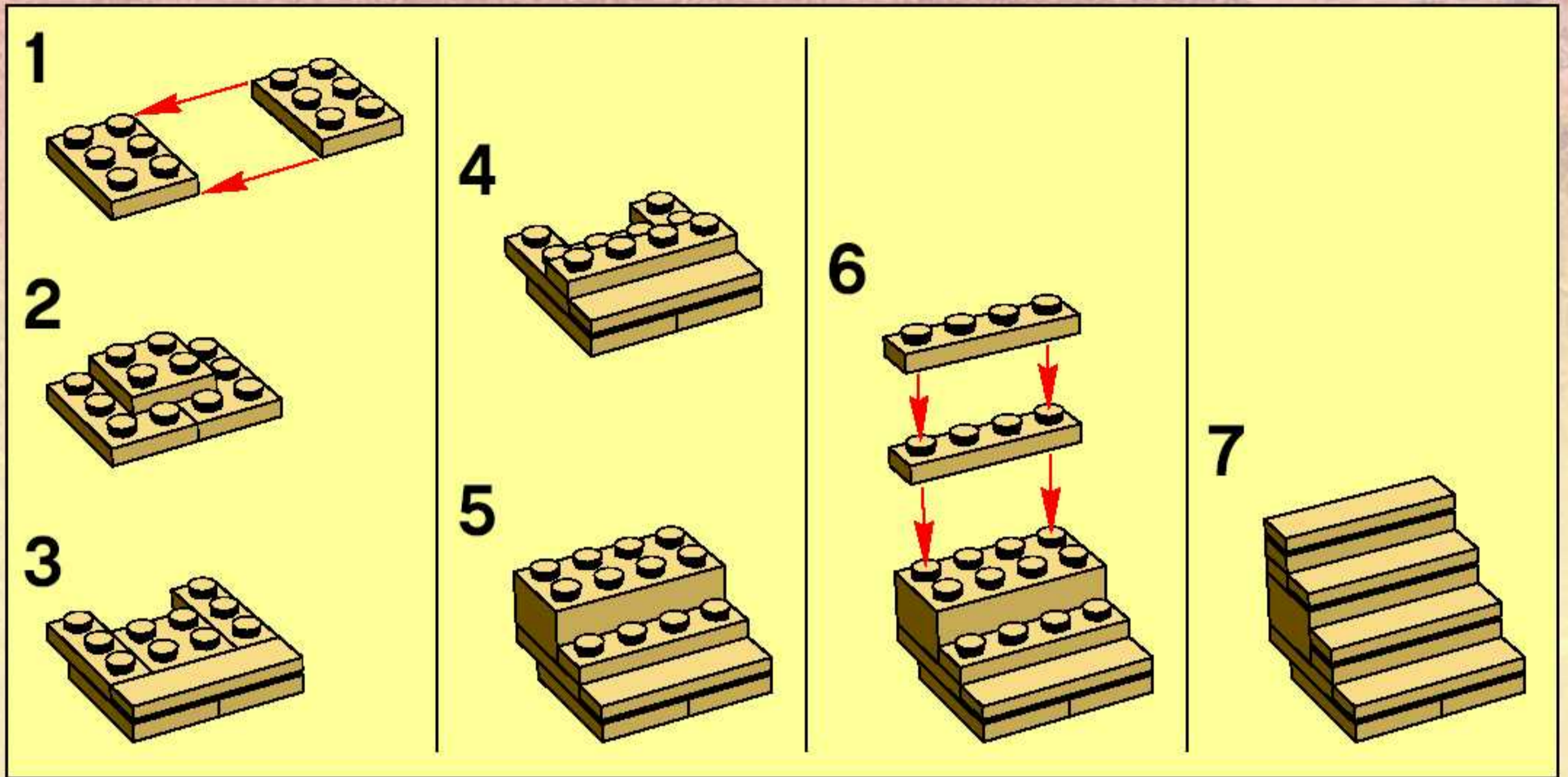

10

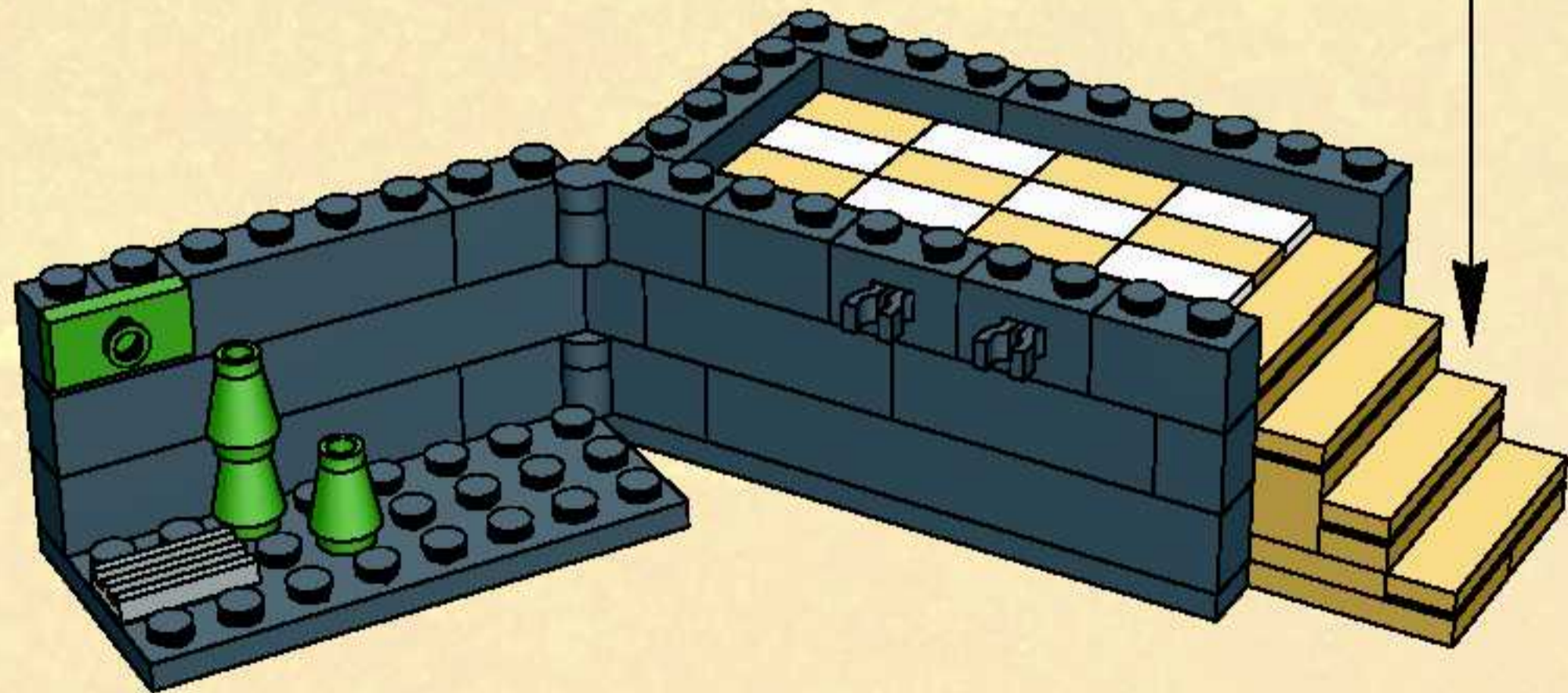

11

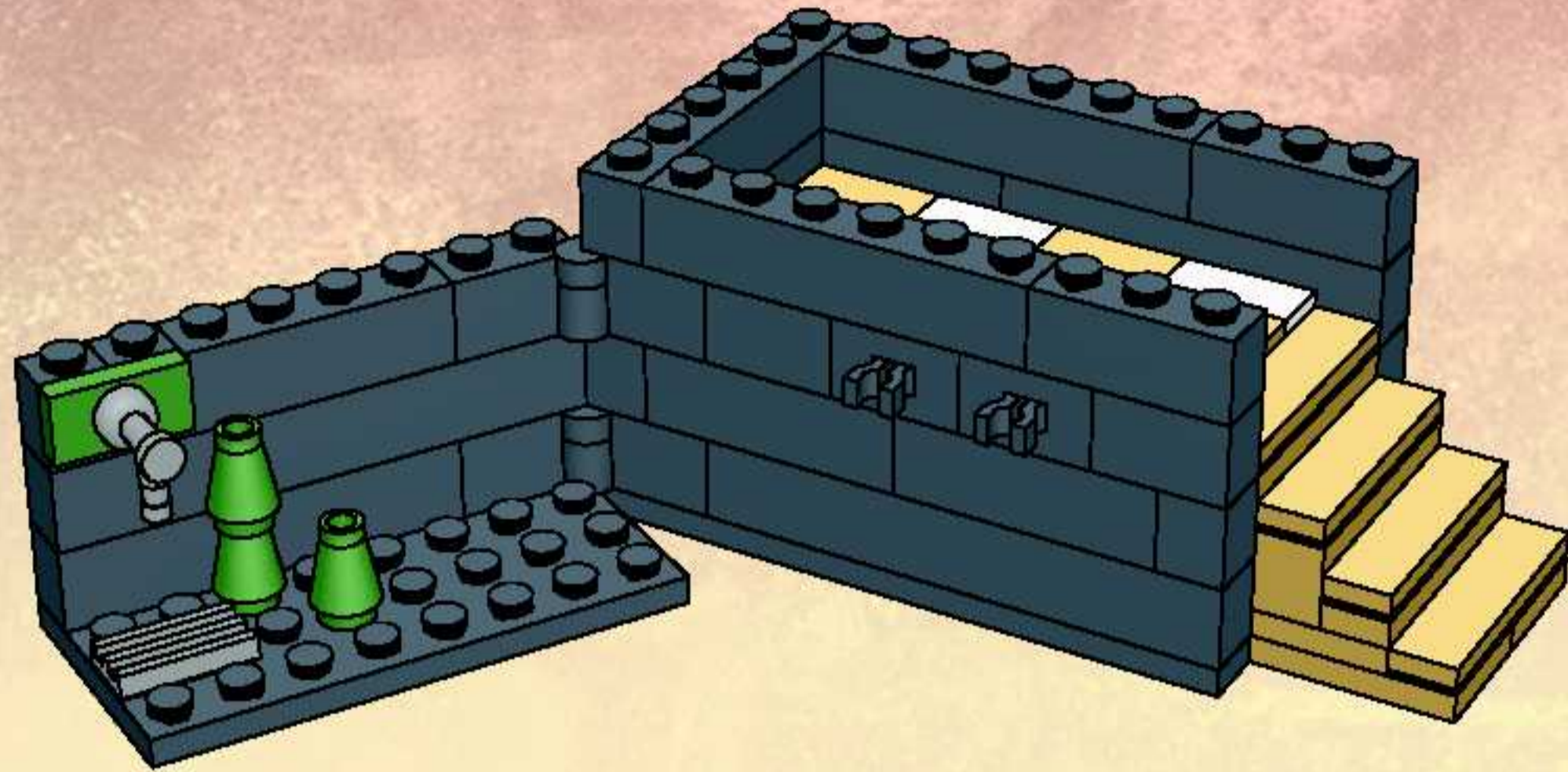

12

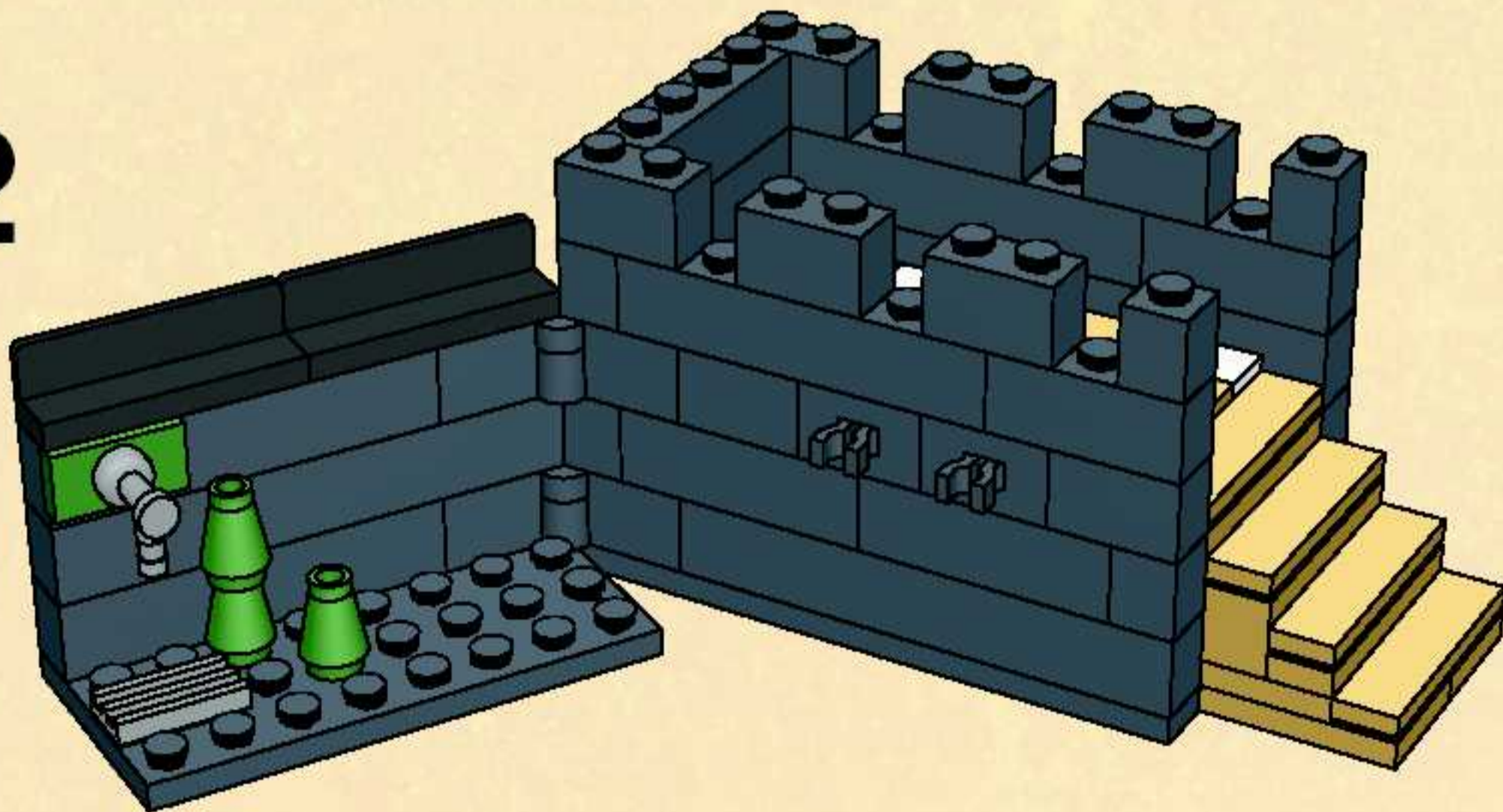

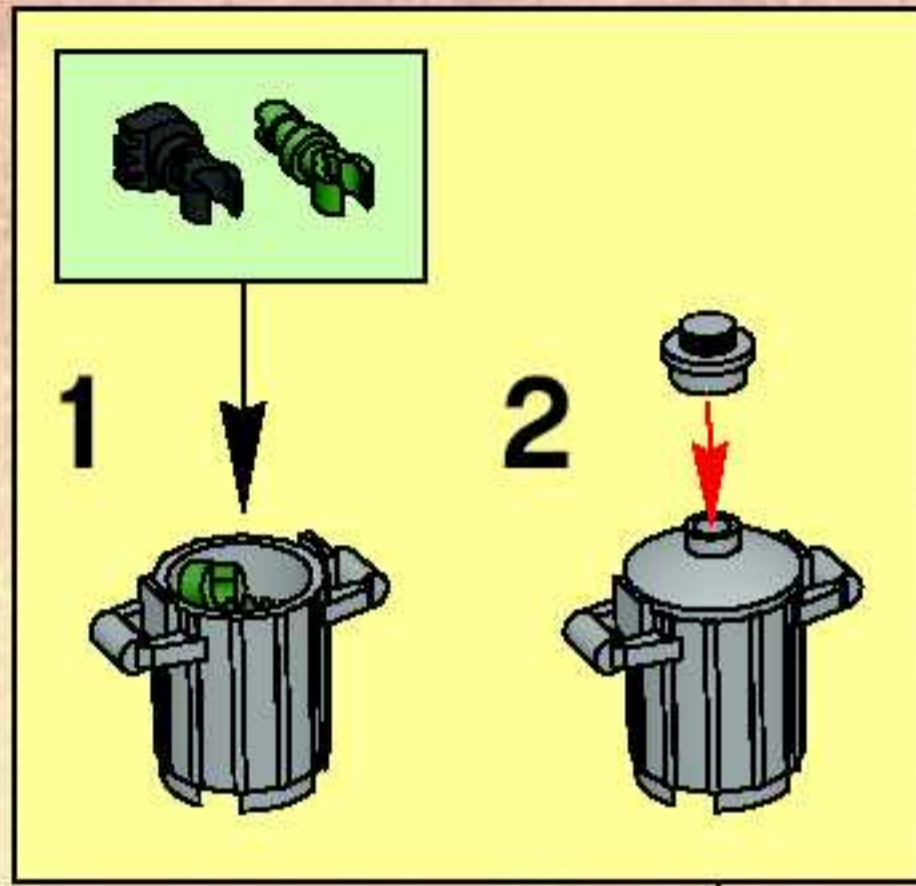

13

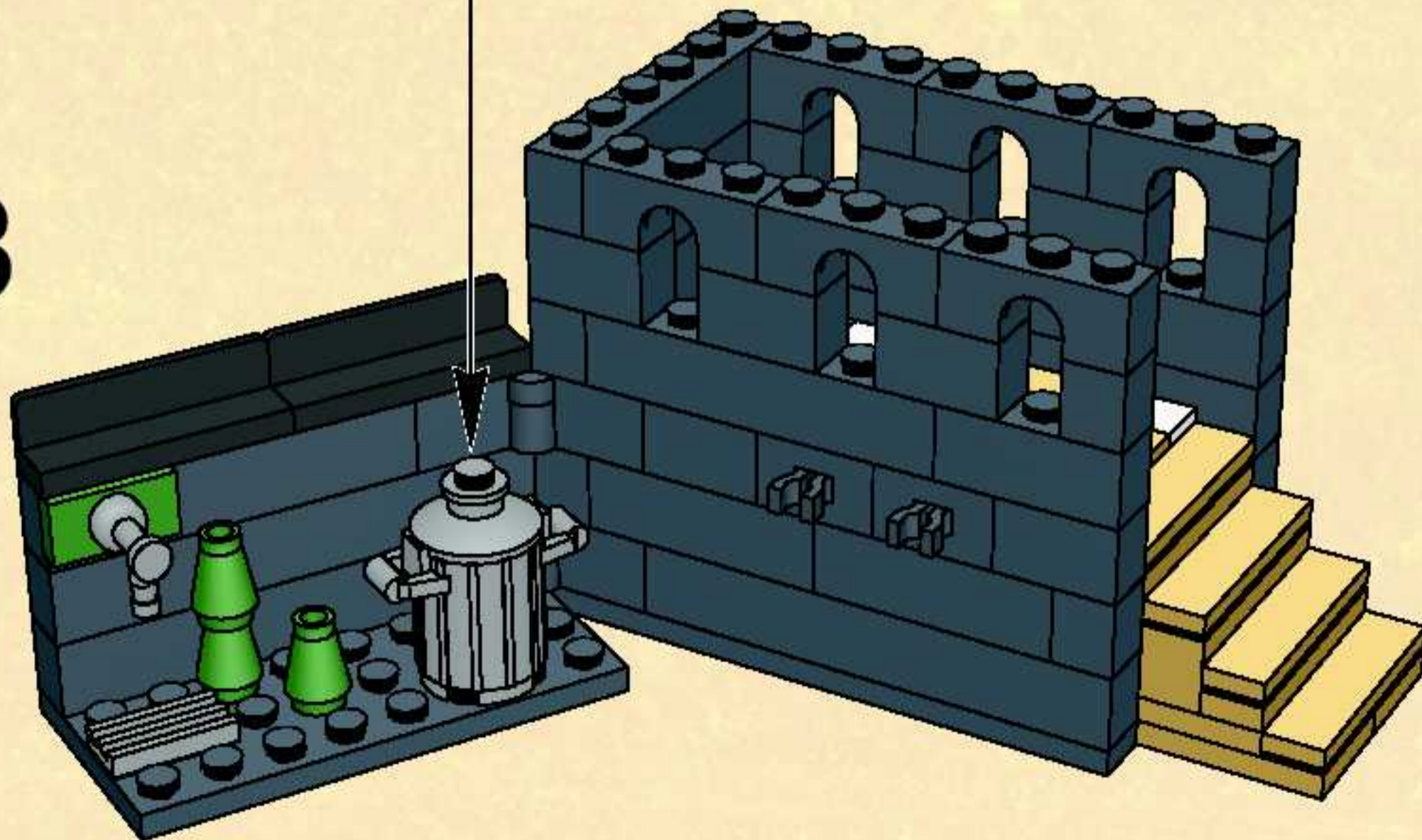

14

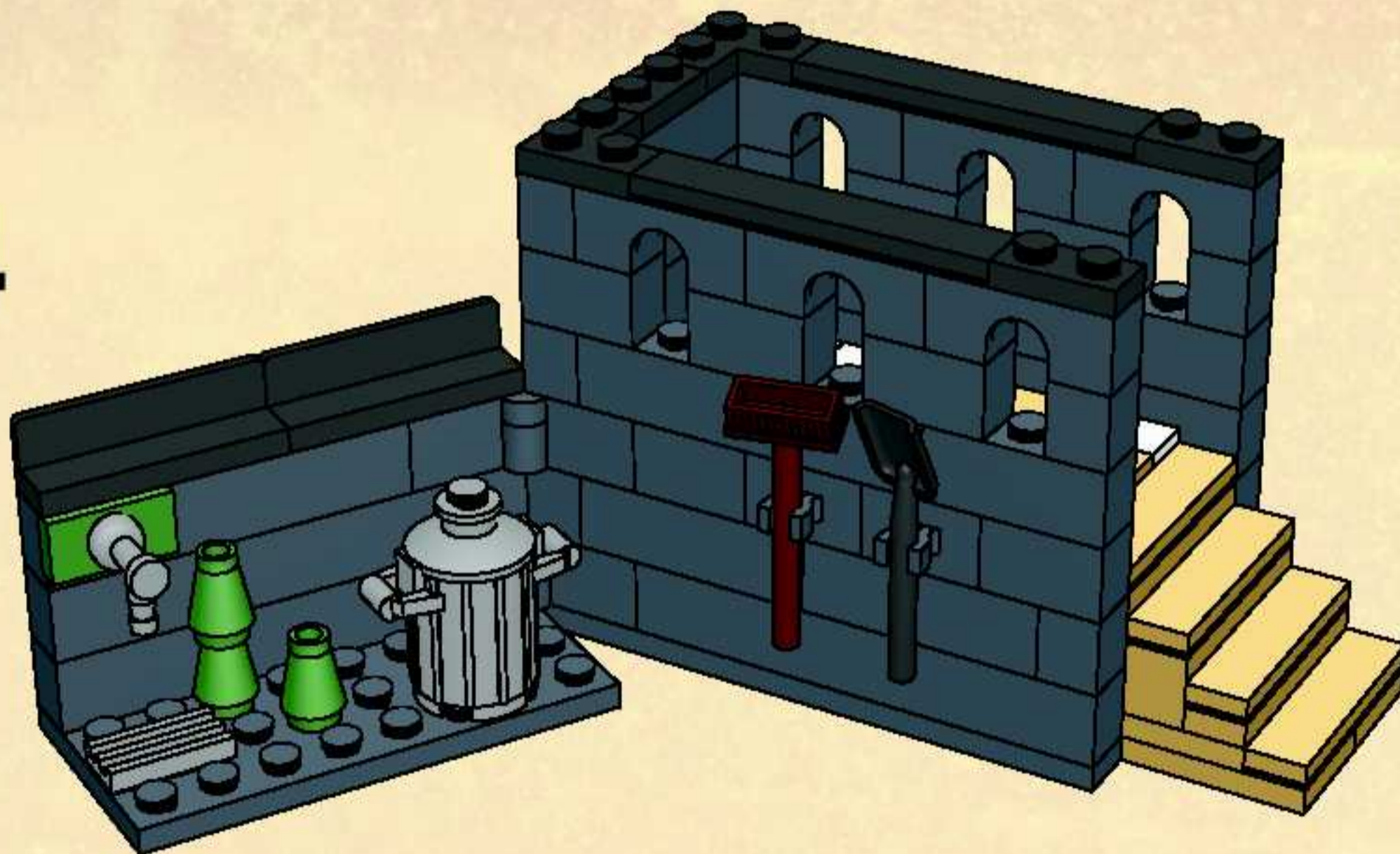

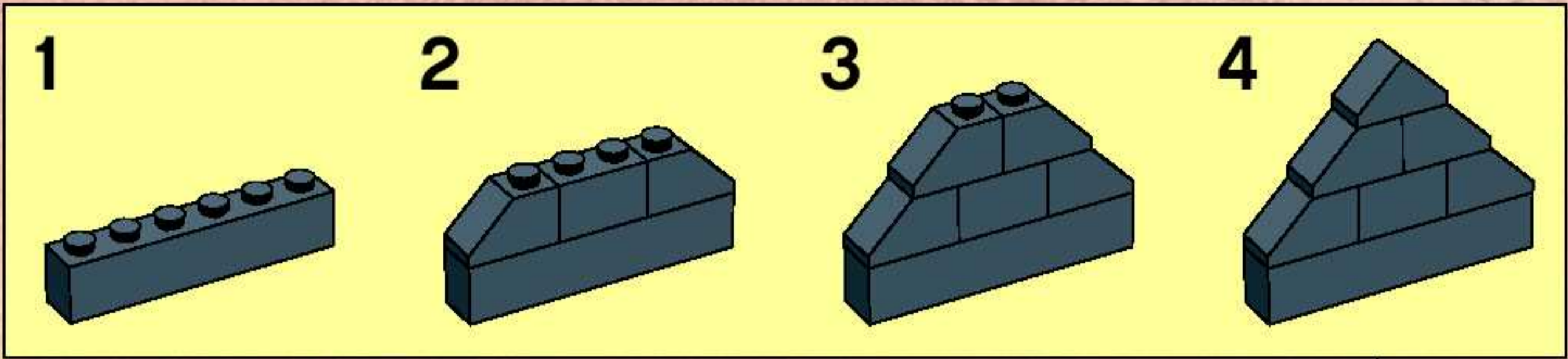

15

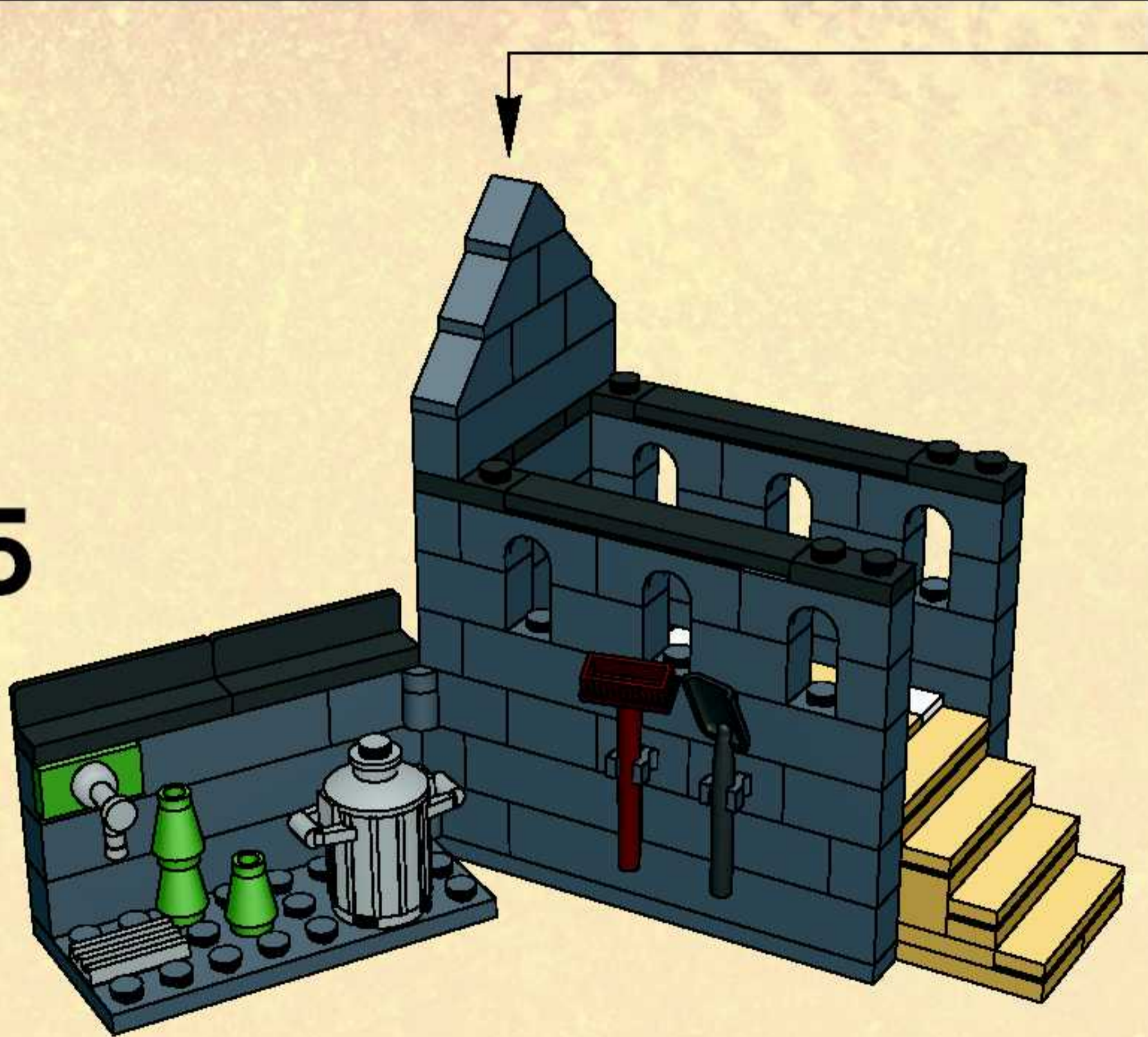

1

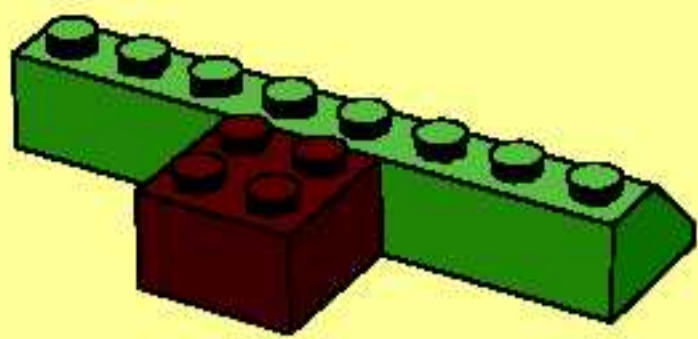

4

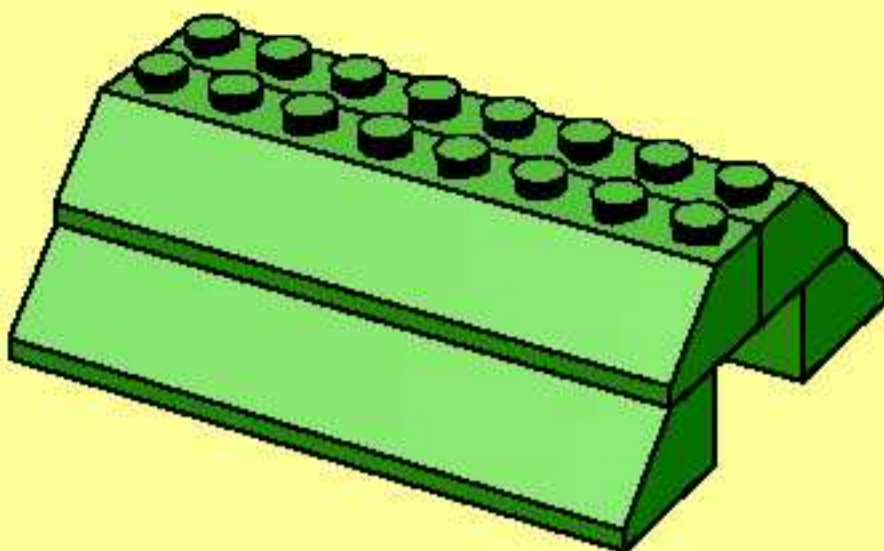

5

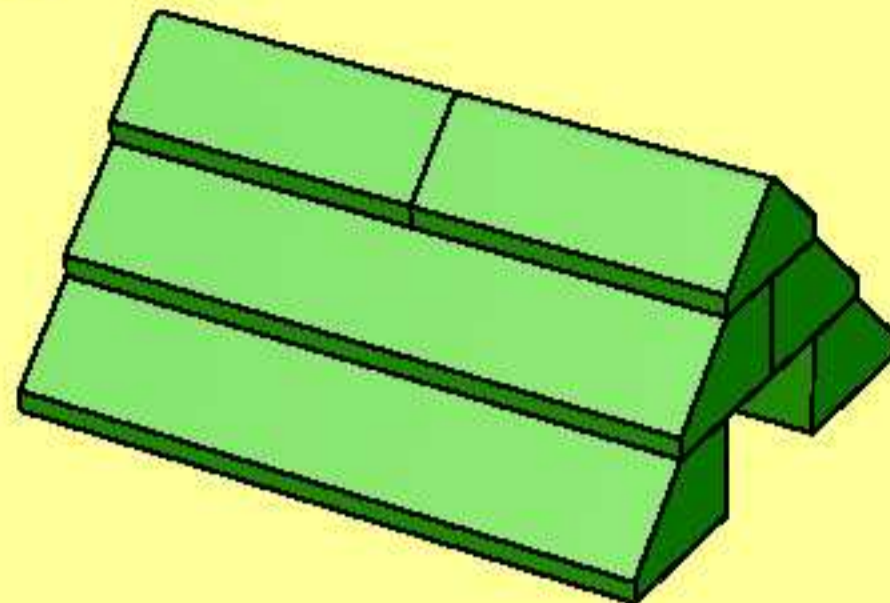

2

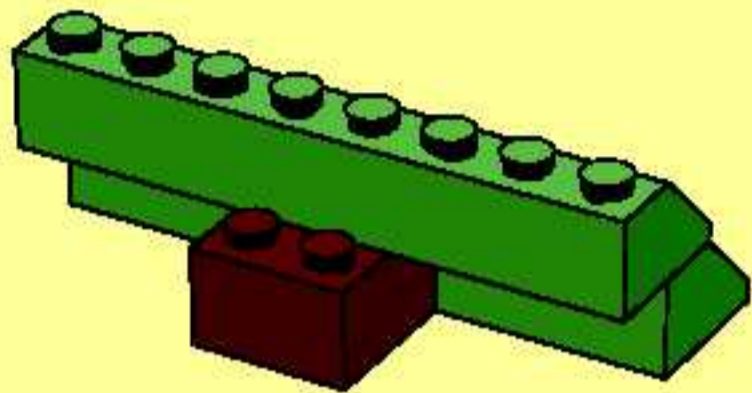

3

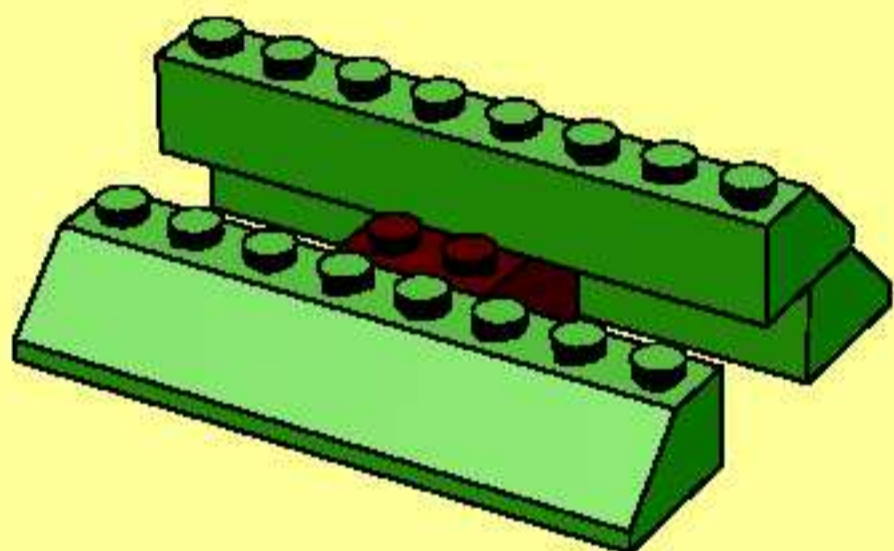

16

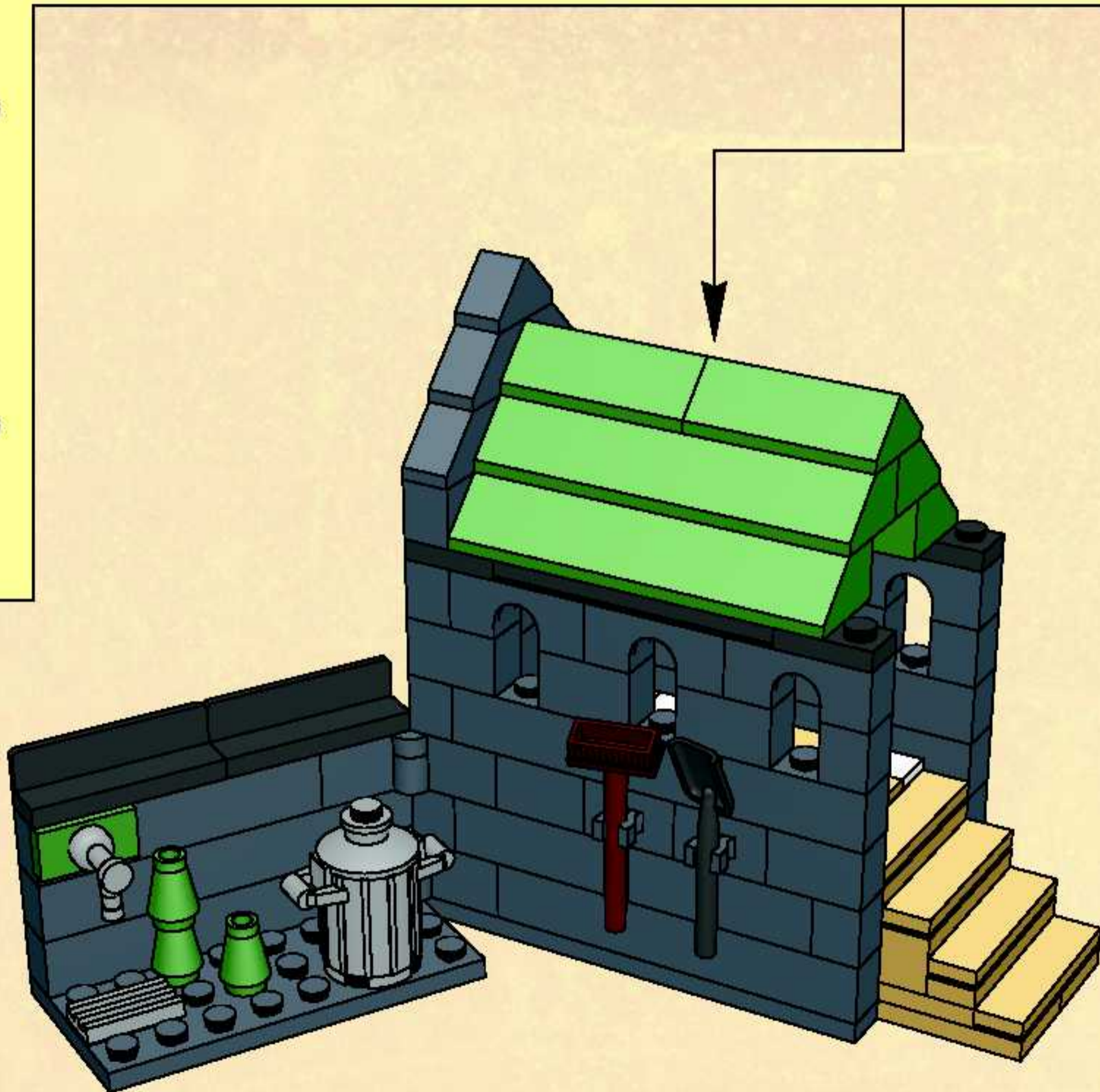

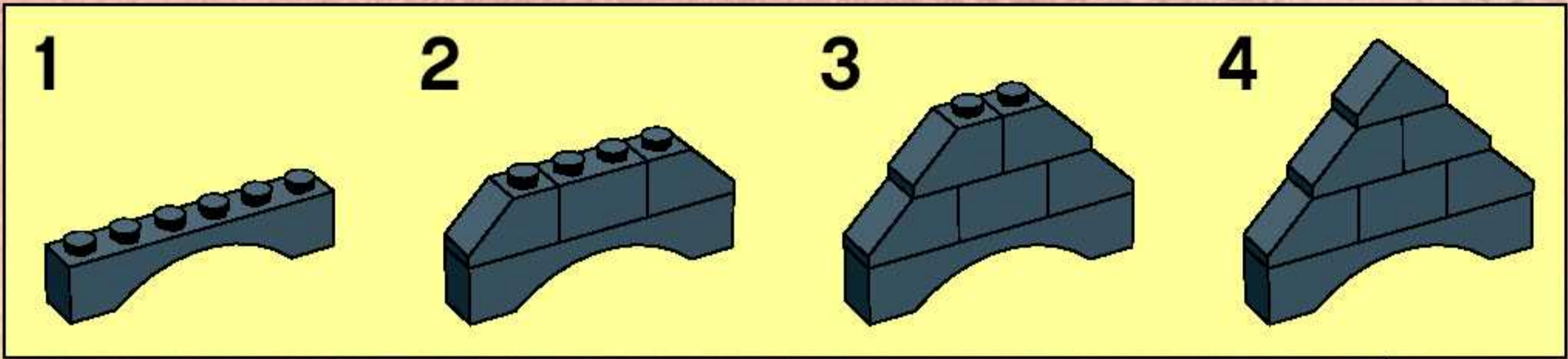

17



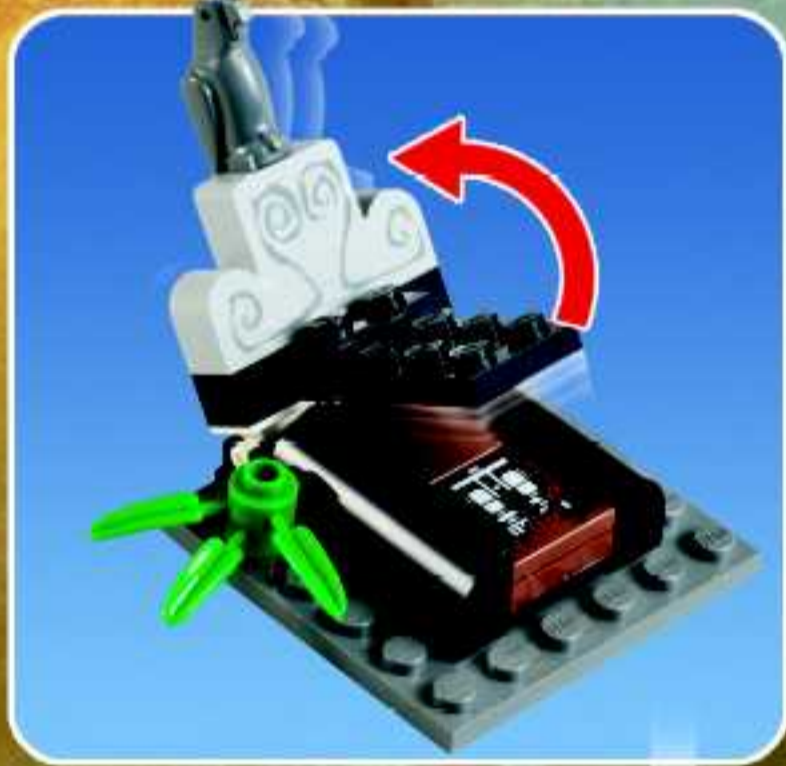





LEGO

Harry Potter



4767



4768



4762



4766



club

Win! Gagne!



FREE! Each LEGO Magazine Features...
• Awesome creations by Kids like you!
• Cool Comics & Stories
• Building Tips & Ideas
• Special Offers & Contest to WIN Prizes!

GRATUIT!

Chaque Magazine LEGO offre...
• Des créations épatantes par des jeunes comme toi!
• Des bandes dessinées et des récits super cool
• Des idées de construction
• Des offres spéciales et des concours pour gagner des prix!

Join Today! Abonne-toi dès aujourd'hui!

1-866-534-6258

www.LEGOclub.com

WIN LEGO® PRODUCTS

Log on to www.acnielsen.aim.dk/LEGO for further instructions.

GAGNE DES PRODUITS LEGO®

Visite www.acnielsen.aim.dk/LEGO pour plus d'informations.

ESTIMADO USUARIO LEGO®

Al contestar algunas preguntas en Ingles, frances, aleman o japones en el sitio www.acnielsen.aim.dk/LEGO, podras participar en el sorteo de algunas vallosos premios LEGO®.

www.acnielsen.aim.dk/LEGO



LEGO, the LEGO logo are trademarks of/son des marques de commerce de/The LEGO Group. ©2005 The LEGO Group.

YES! I WANT TO JOIN THE LEGO® CLUB!

This coupon is good for 1 **FREE** 2-year Club membership. Additional kids may sign up for \$7.95 in the US and in Canada 10.70 (including taxes).

PLEASE PRINT IN ALL CAPITAL LETTERS

OUI! JOIGNEZ-MOI AU CLUB LEGO®!

Ce coupon est valide pour 1 abonnement **GRATUIT** de 2 ans. Enfants additionnels peuvent s'inscrire pour 10,70 \$ (taxes incluses).

S.V.P. IMPRIMER EN LETTRES MAJUSCULES.

B125

Name/Nom _____ Age _____ Français English

Address/Adresse _____ Girl/Fille Boy/Garçon

City/Ville _____ State/Prov. _____ Postal Code
Code Postal _____

E-mail Address/Courriel _____ Date of Birth
Date de Naissance _____ / _____ / _____
M D/Y Y/A

Parent's Signature/Signature d'un parent _____

Mail to/Poster à:
LEGO Club
P. O. Box 1157
EnField, CT 06083-1157



Offer limited to residents of US and Canada. No photocopies will be accepted. Offer limited to two free memberships per family, group or organization. Please allow 4-6 weeks for delivery of your first mailing.

Offre limitée pour résidents du US et Canada. Photocopies ne seront pas acceptées. Offre limitée à deux abonnements gratuits par famille, groupe, ou organisation. Allouez 4-6 semaines pour la première livraison.

**FREE
LEGO Magazine
with this coupon!
Magazines LEGO
GRATUITS
avec ce coupon!**



SHOP at HOME

The World's Biggest LEGO® Shop!



For a Free Catalog in the U.S.
and Canada, call toll-free:

1-800-446-8107

Or go online:

www.LEGOshop.com/catalog

Pour obtenir un Catalogue GRATUIT
aux États-Unis et au Canada,
téléphonez sans frais au :

1-800-267-5346

Ou venez en ligne sur :

www.LEGOshop.com/catalog



LEGO, the LEGO logo are trademarks of the LEGO Group. ©2005 The LEGO Group.

FREE LEGO® Catalog!

Please print with a pen in capital letters.

First Name
Prénom _____

Last Name
Nom _____

Address
Adresse _____

City
Ville _____

State
Prov. _____

Zip Code
Code Postal _____

Phone (optional)
No de téléphone
(optionnel) _____

Email (optional)
Courriel (optionnel) _____

Check Below / Indiquer ci-bas

I speak English

Je parle Français

Boy/Garçon

Girl/Fille

Catalogue LEGO® Gratuit!

S.V.P. Écrire en lettres majuscules avec un stylo à bille noir.

CRBP05

Mail to/Poster à:



SHOP at HOME

P. O. Box 1221
Enfield, CT 06083-1221



U.S. and Canada only
É.-U. et Canada seulement

Please allow 2-4 weeks for delivery.

Veuillez s.v.p. allouer 2 à 4
semaines pour l'expédition.



Harry Potter

4283693

©2005 The LEGO Group.



HARRY POTTER, characters, names and related indicia are trademarks of and © Warner Bros. Entertainment Inc. HARRY POTTER, les noms des personnages, leurs représentations et leurs insignes sont des propriétés et des marques de commerce de Warner Bros. Entertainment Inc.

Los personajes, nombres y temas relacionados con HARRY POTTER son marcas registradas de la Warner Bros. Entertainment Inc. Harry Potter Publishing Rights © JKR. Droits de publication Harry Potter © JKR. Harry Potter Derechos Reservados © JKR. (s05)

WB SHIELD: TM & © Warner Bros. Entertainment Inc.

www.harrypotter.com www.LEGO.com