



STAR WARS

7263



Darth Vader™

TIE Fighter Pilot™

STAR WARS
ORIGINAL TRILOGY EDITION

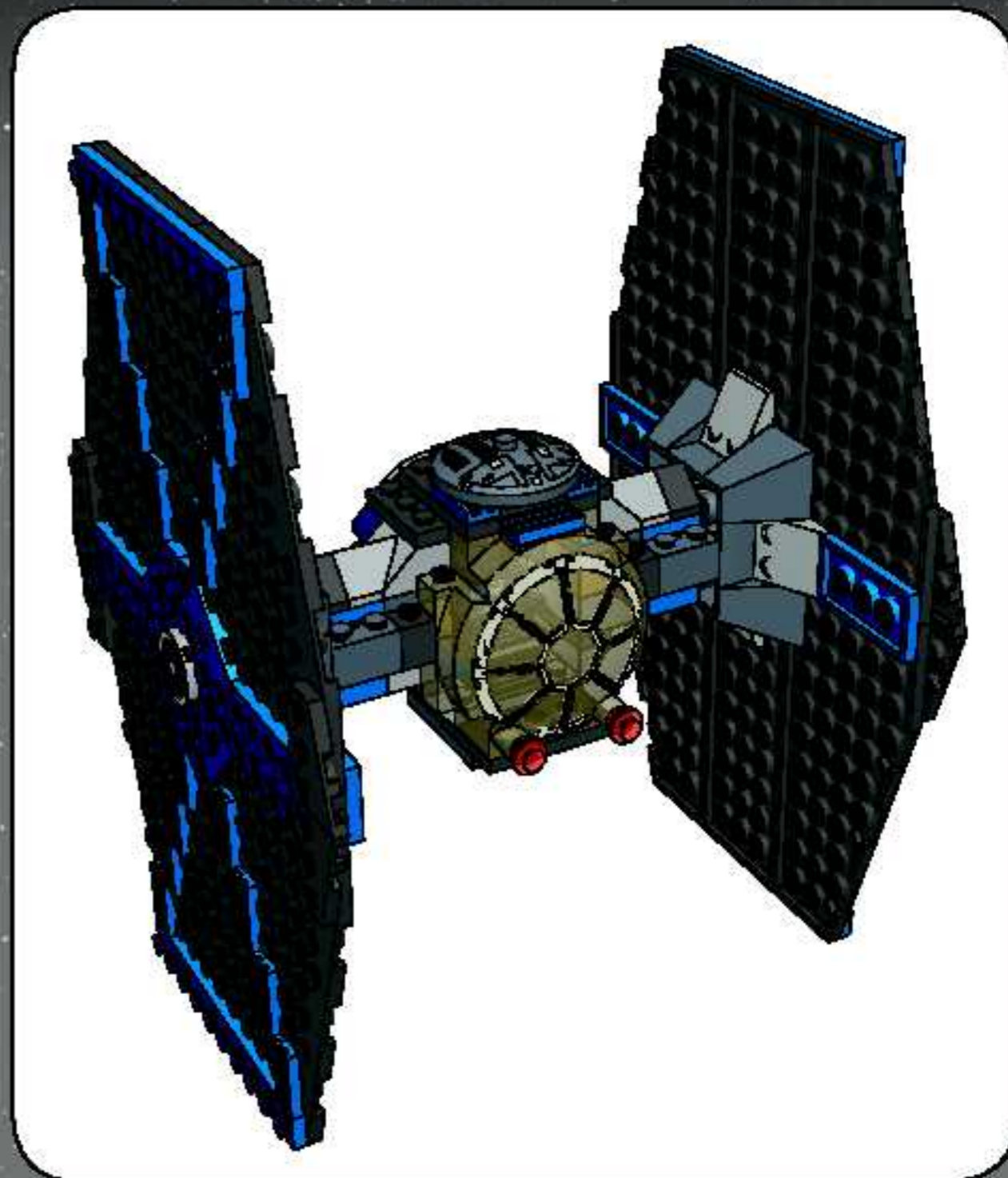
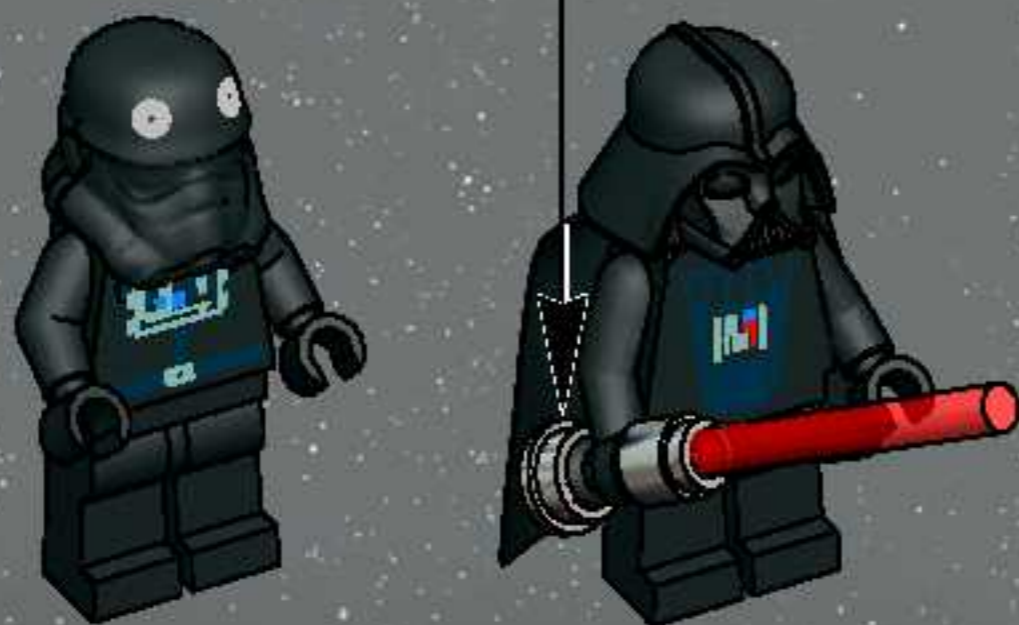

US: When no longer in use, please dispose of the element in an environmentally responsible manner.

CA: Lorsque l'élément est hors d'usage, veuillez s.v.p. le jeter d'une manière responsable sans nuire à l'environnement.

MX: Antes de arrojar a la basura, cuide las normas ambientales.

1

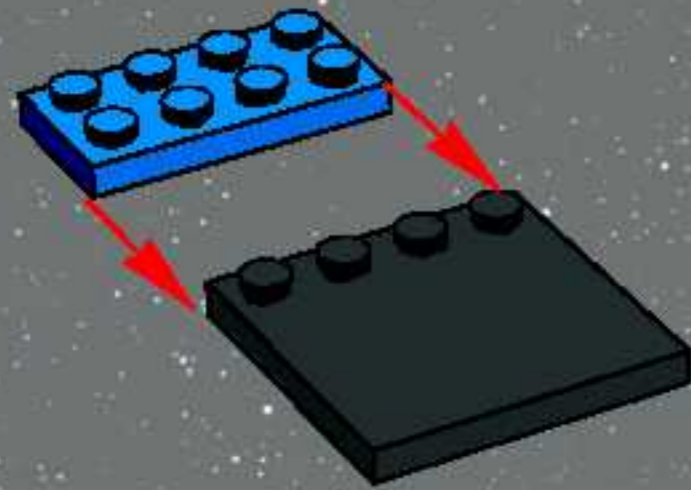

2

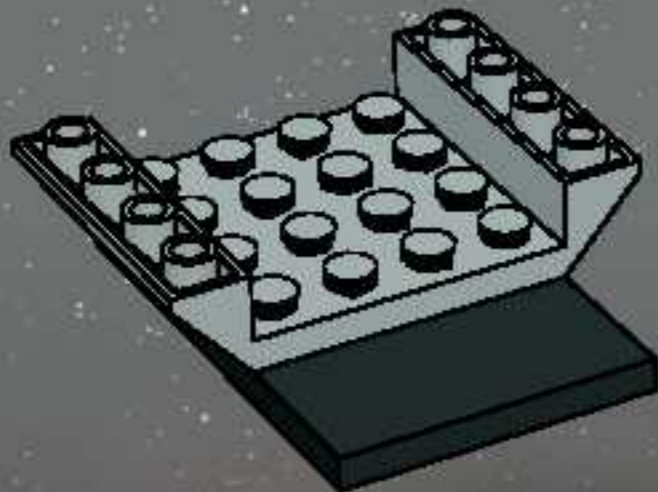

3



4



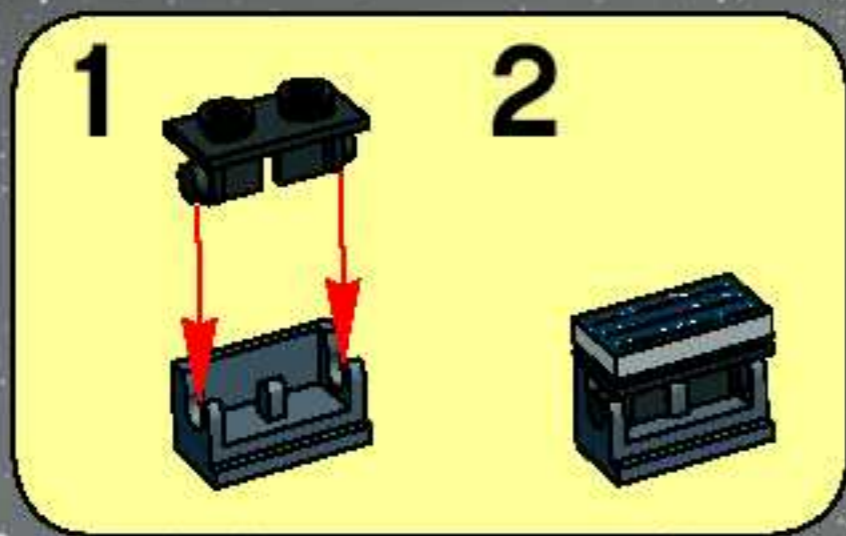

5



6



7



8

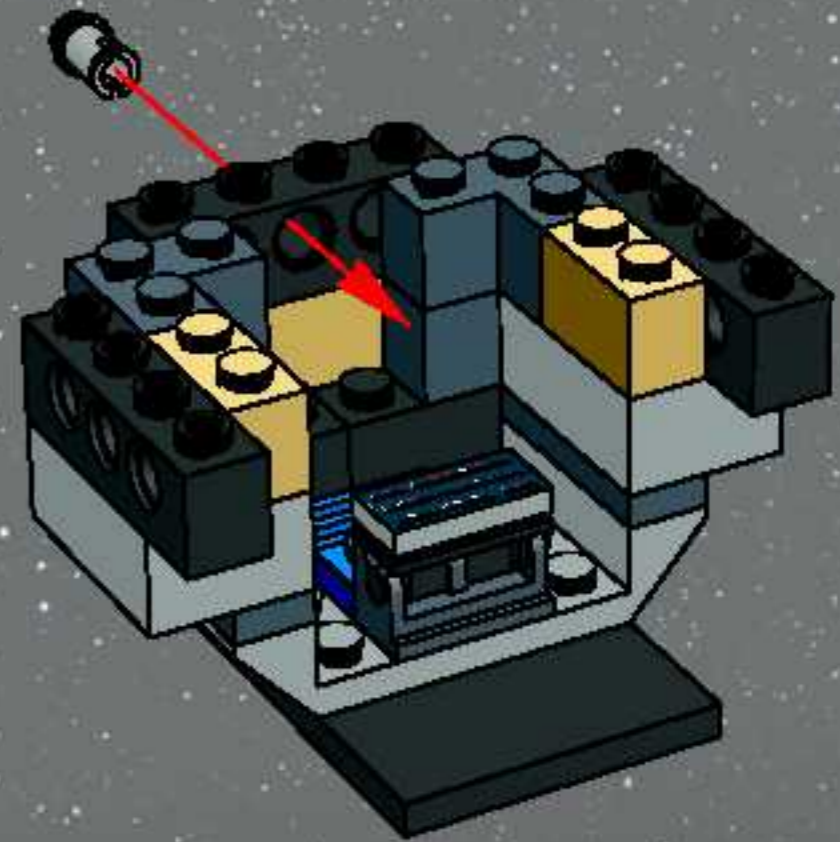

9

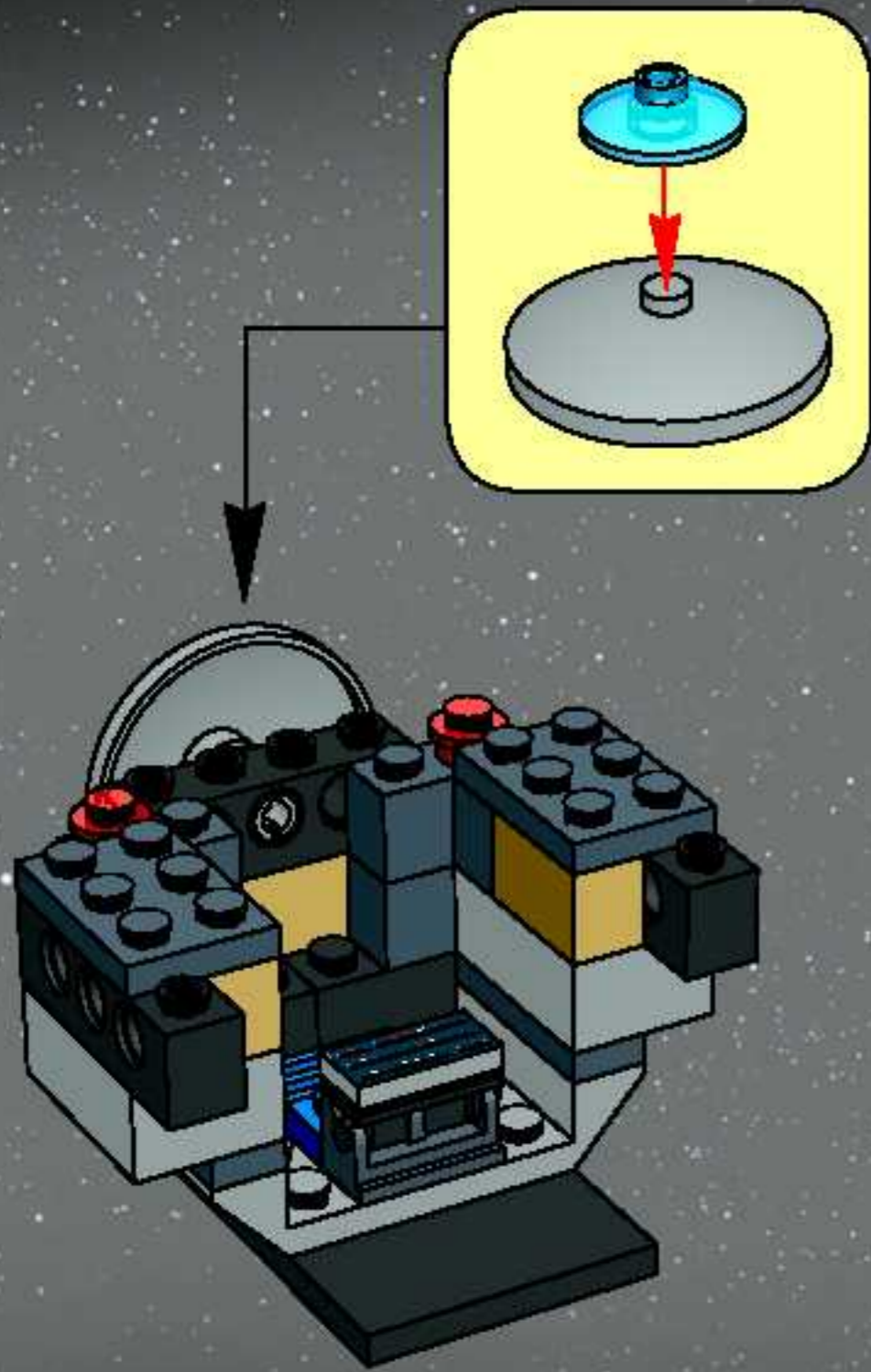

10



11

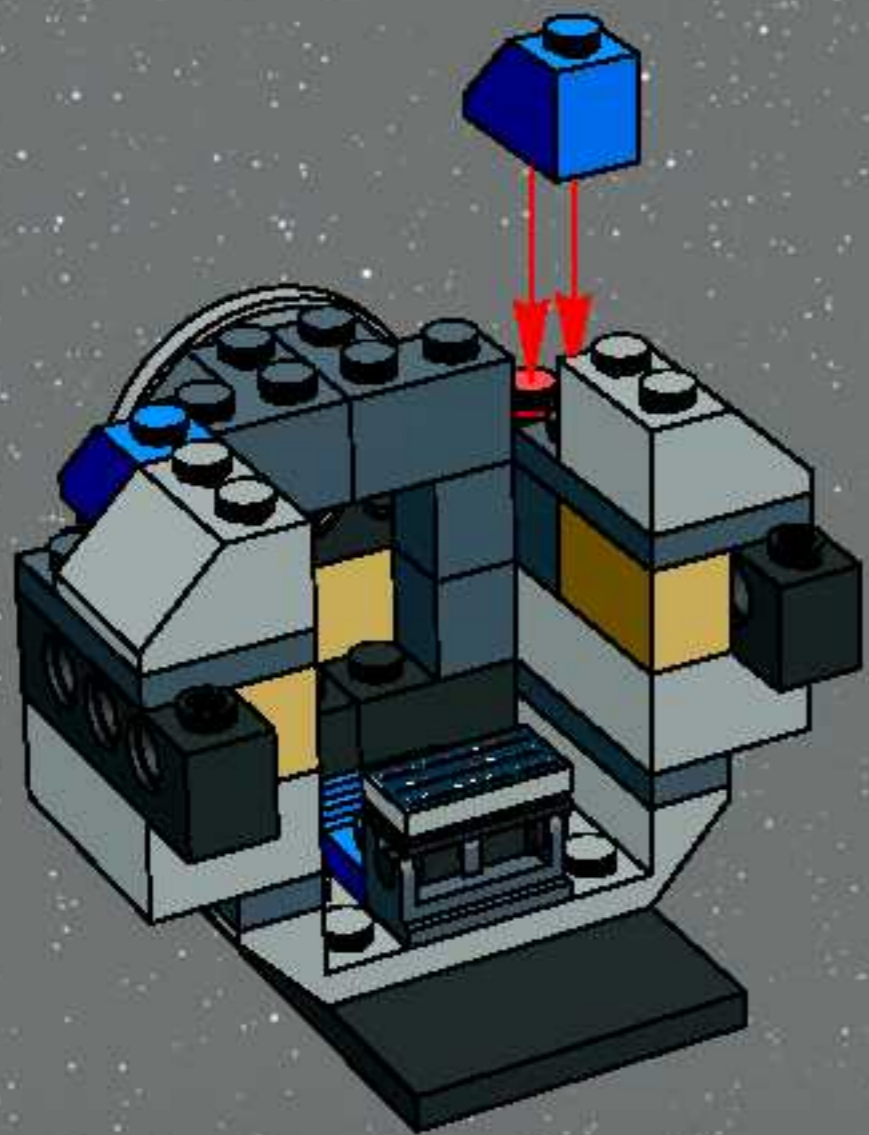

12



1



3



2



4



5

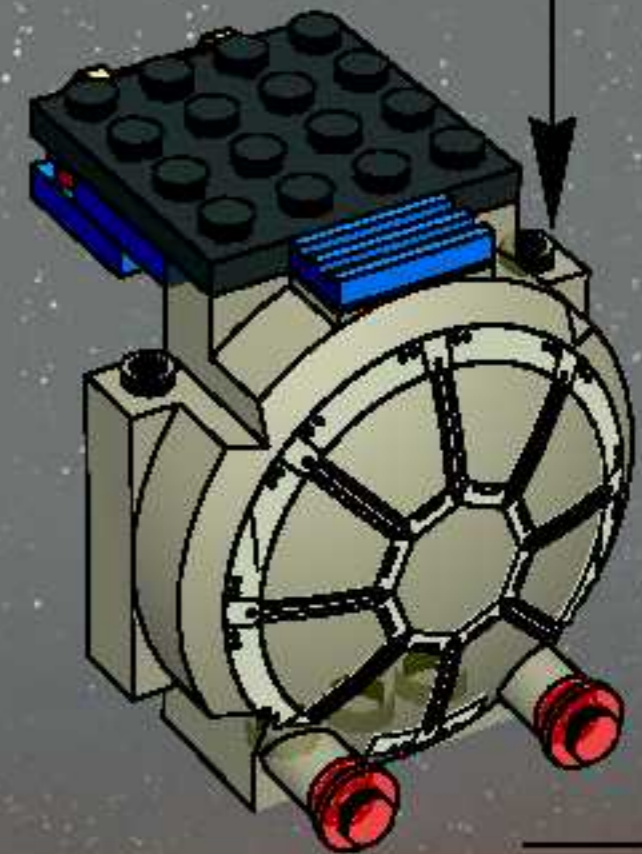
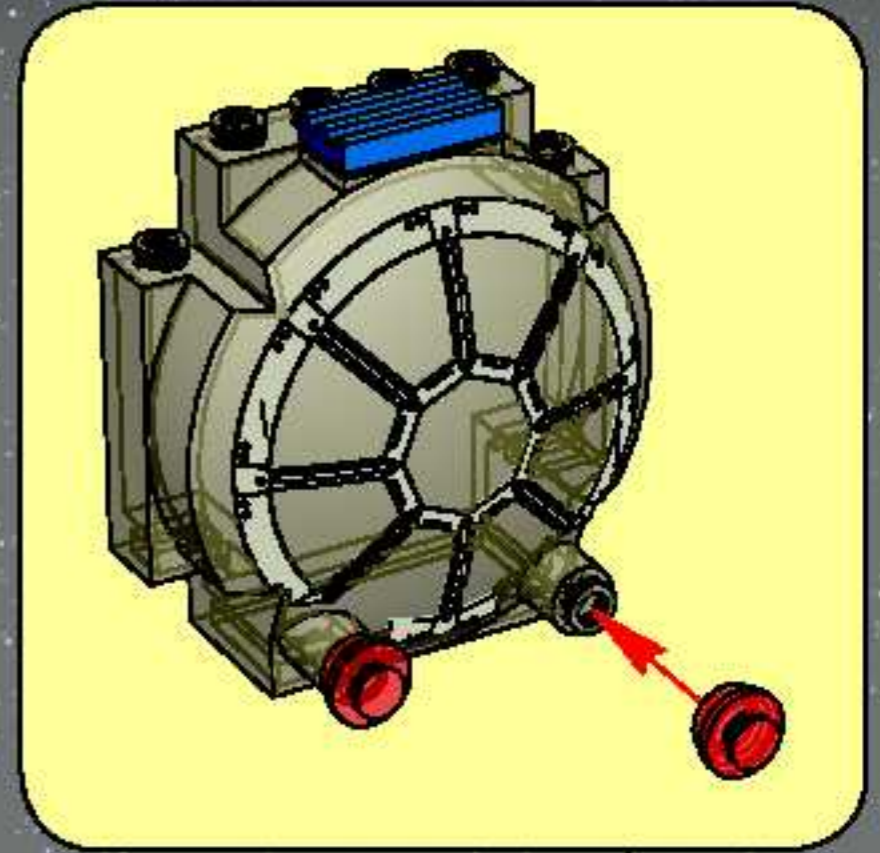

13

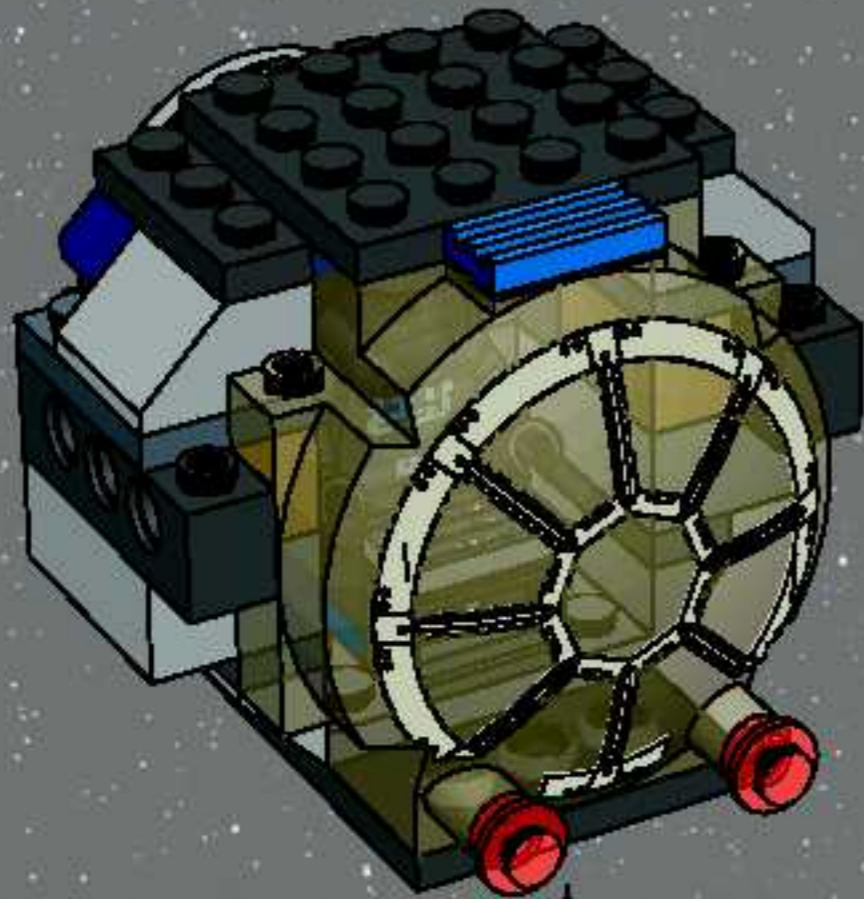

14

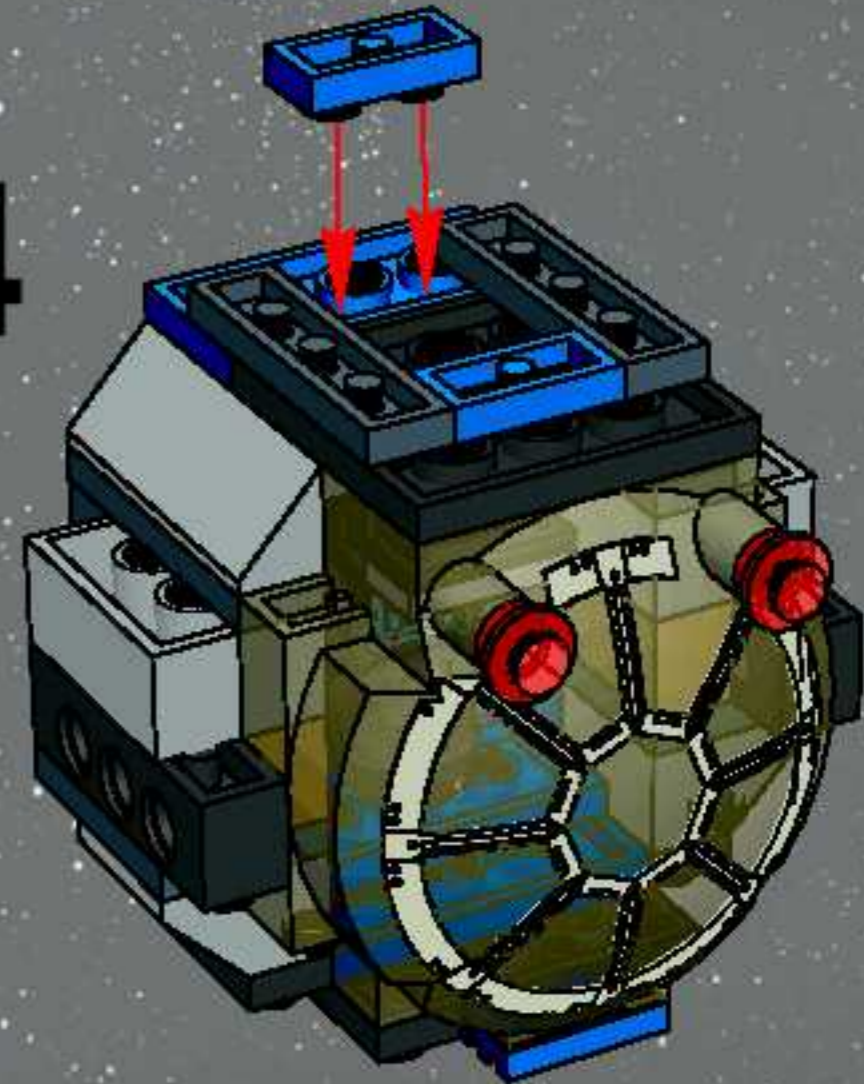

15

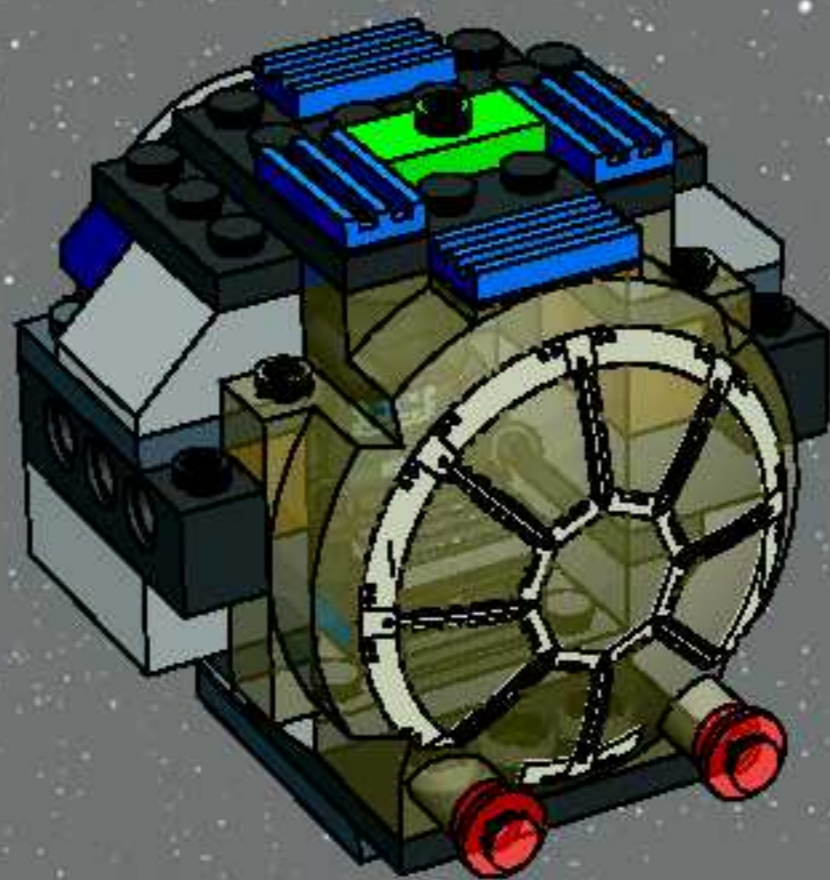

1

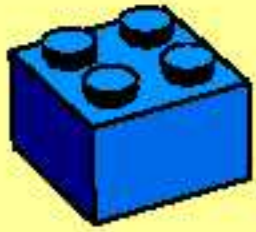

3

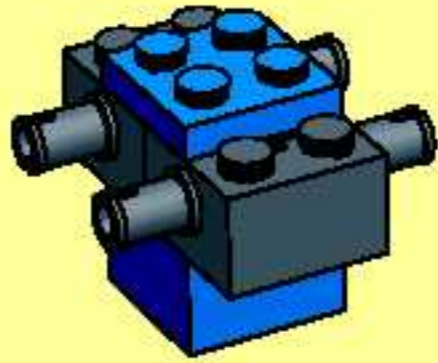

2

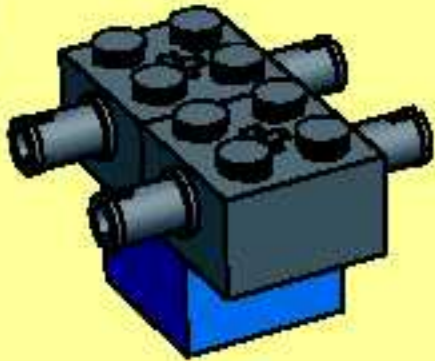

4

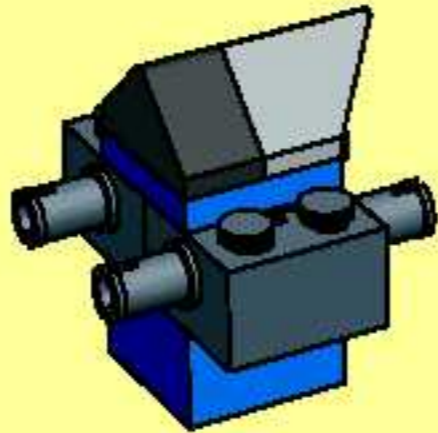

2x

16

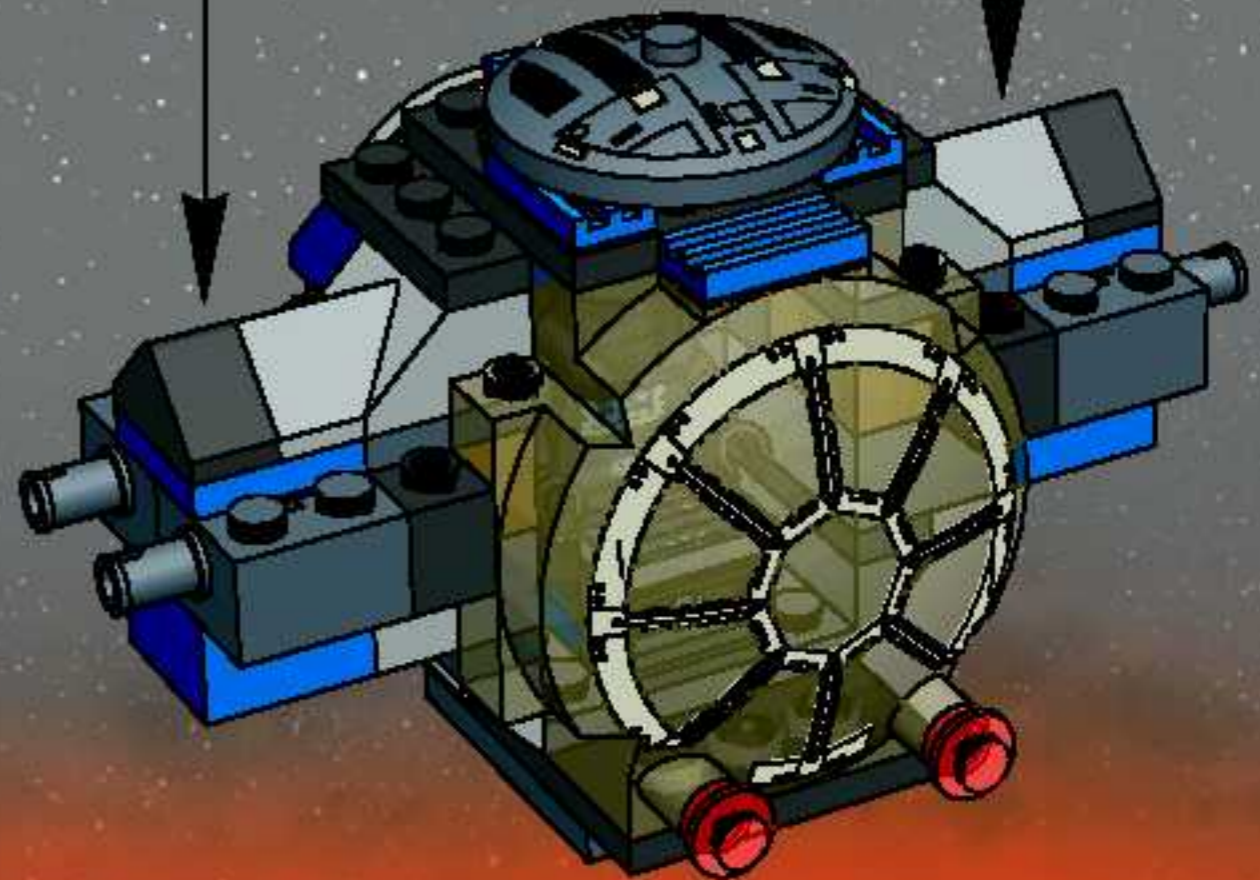

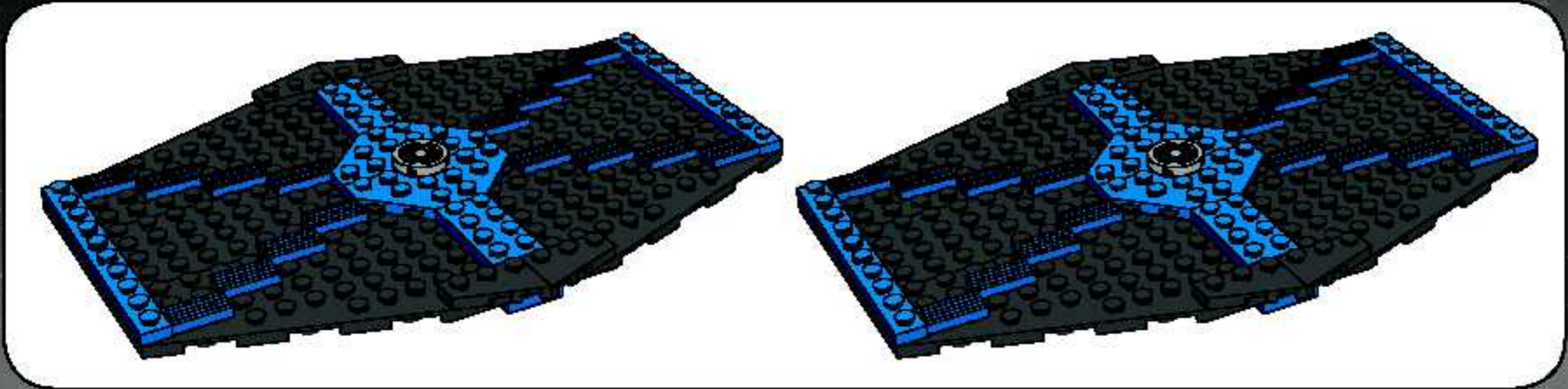

1

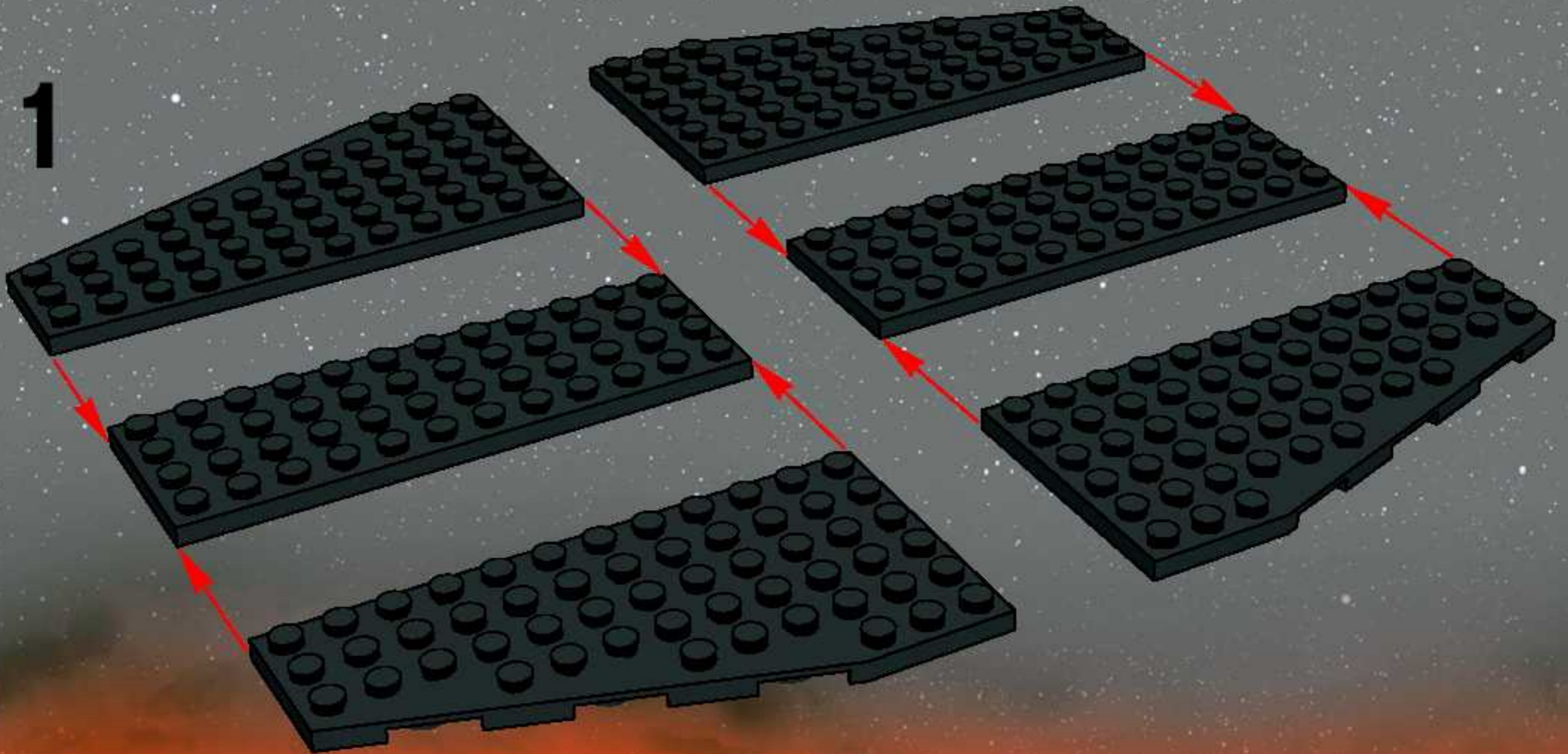

2

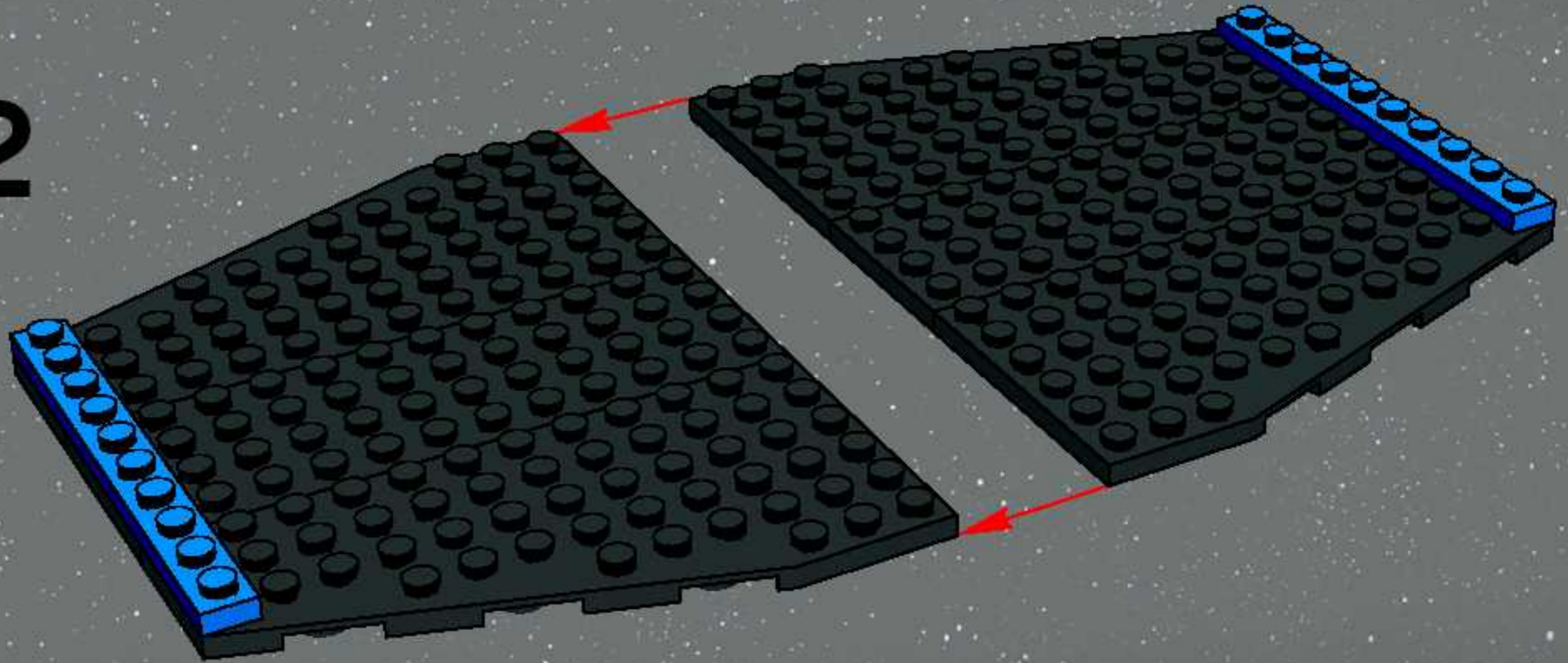

3

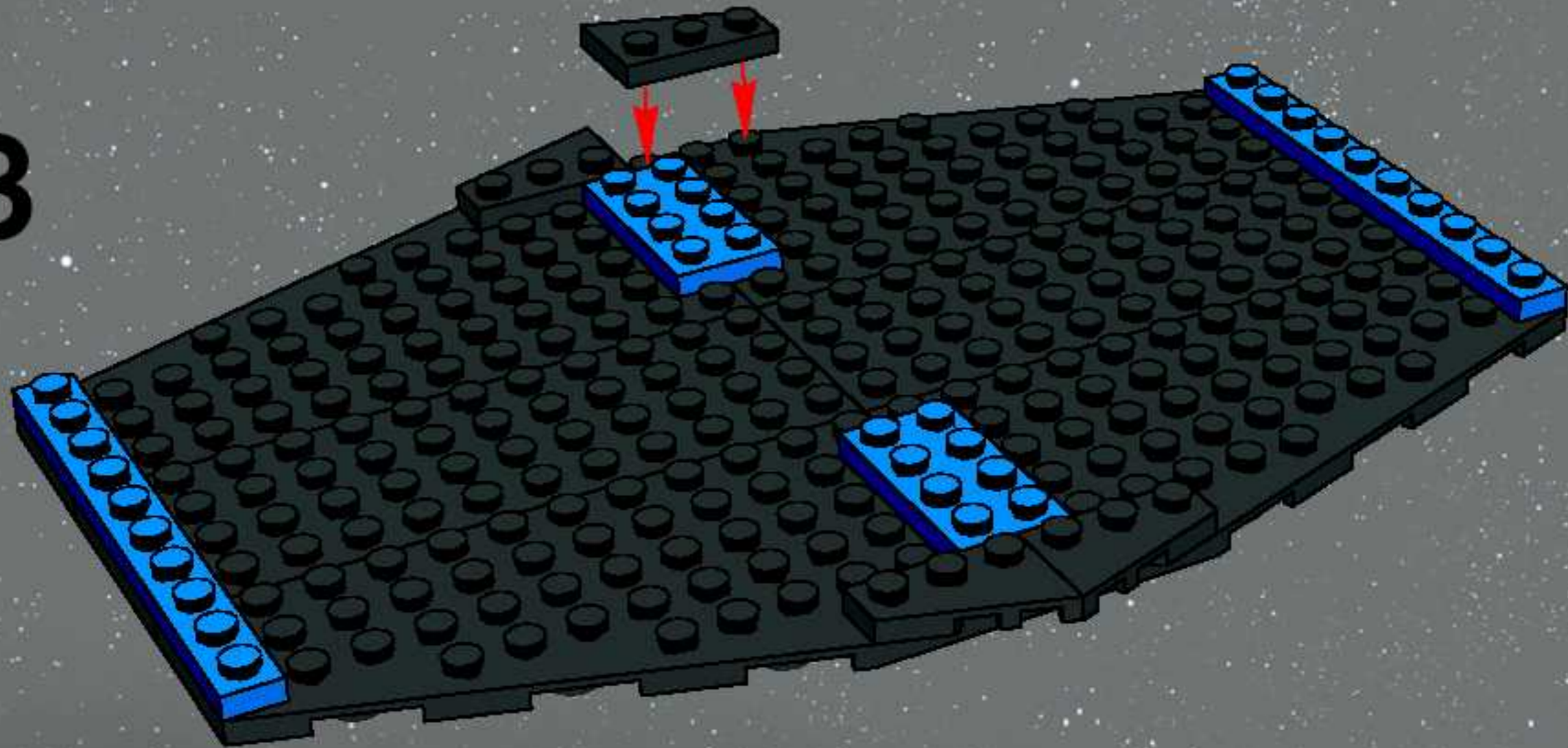

4



5

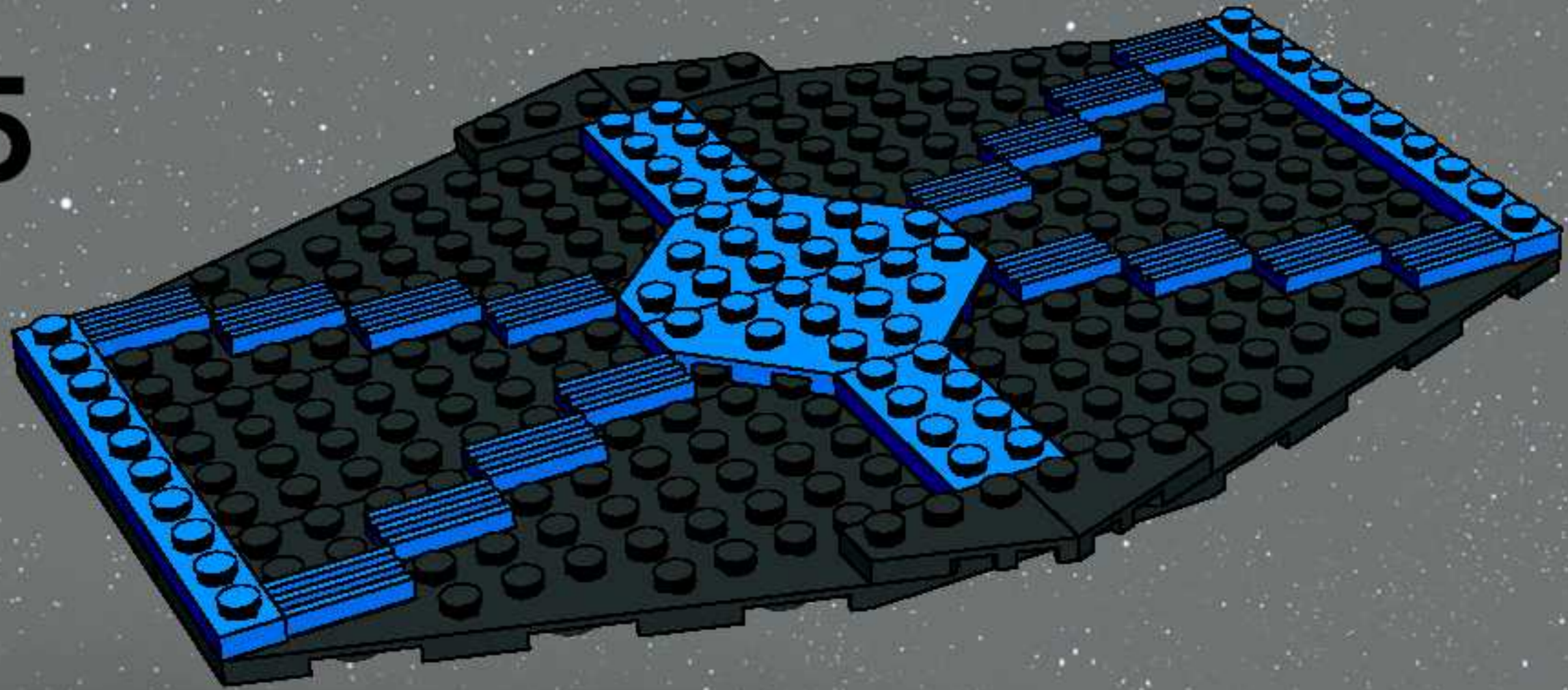

6

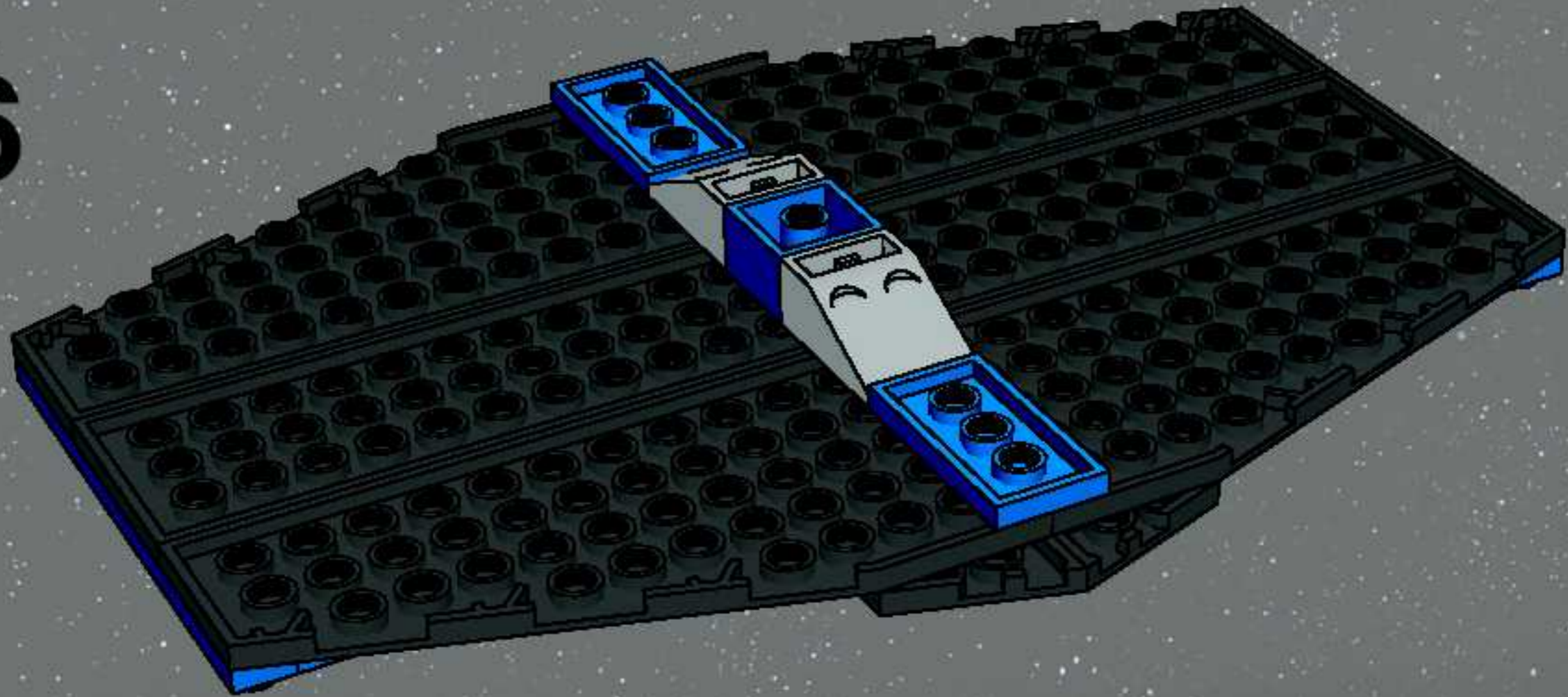

7

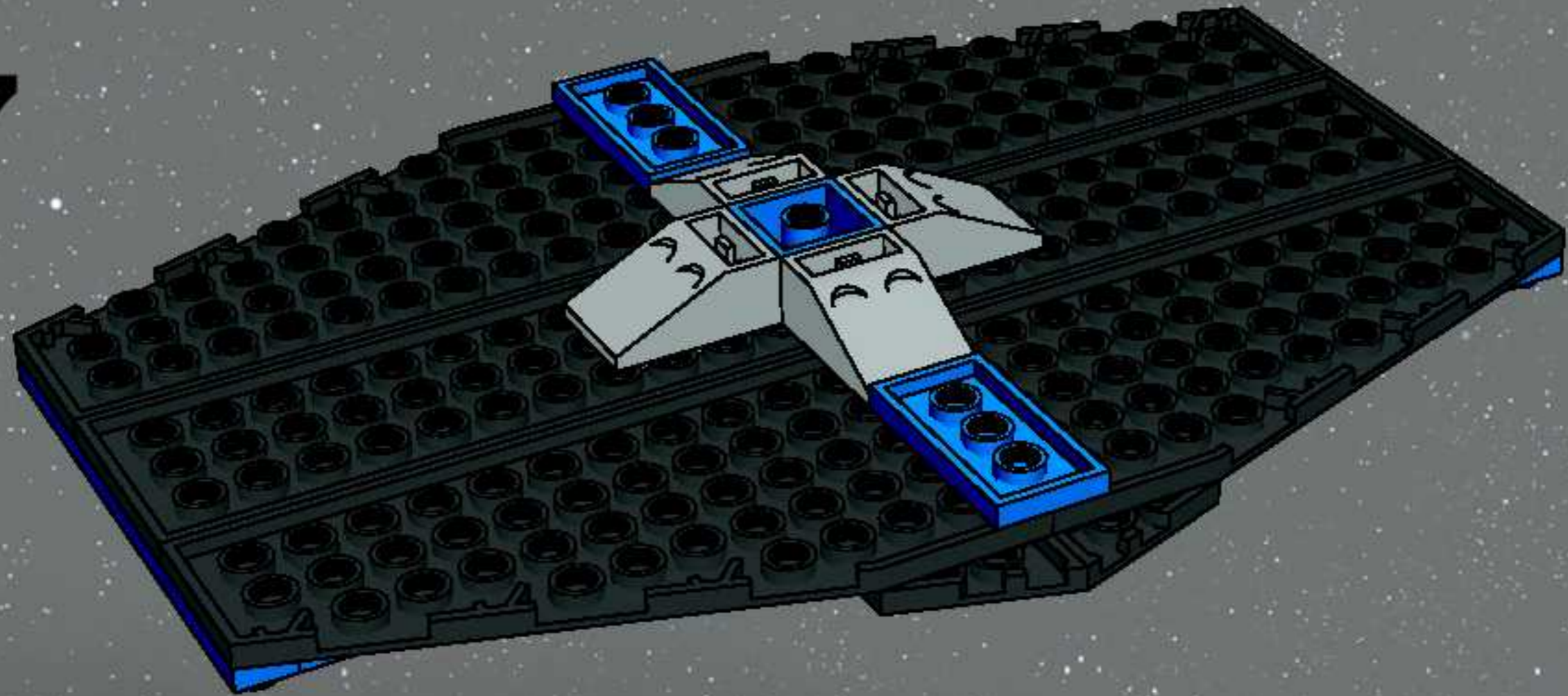

8

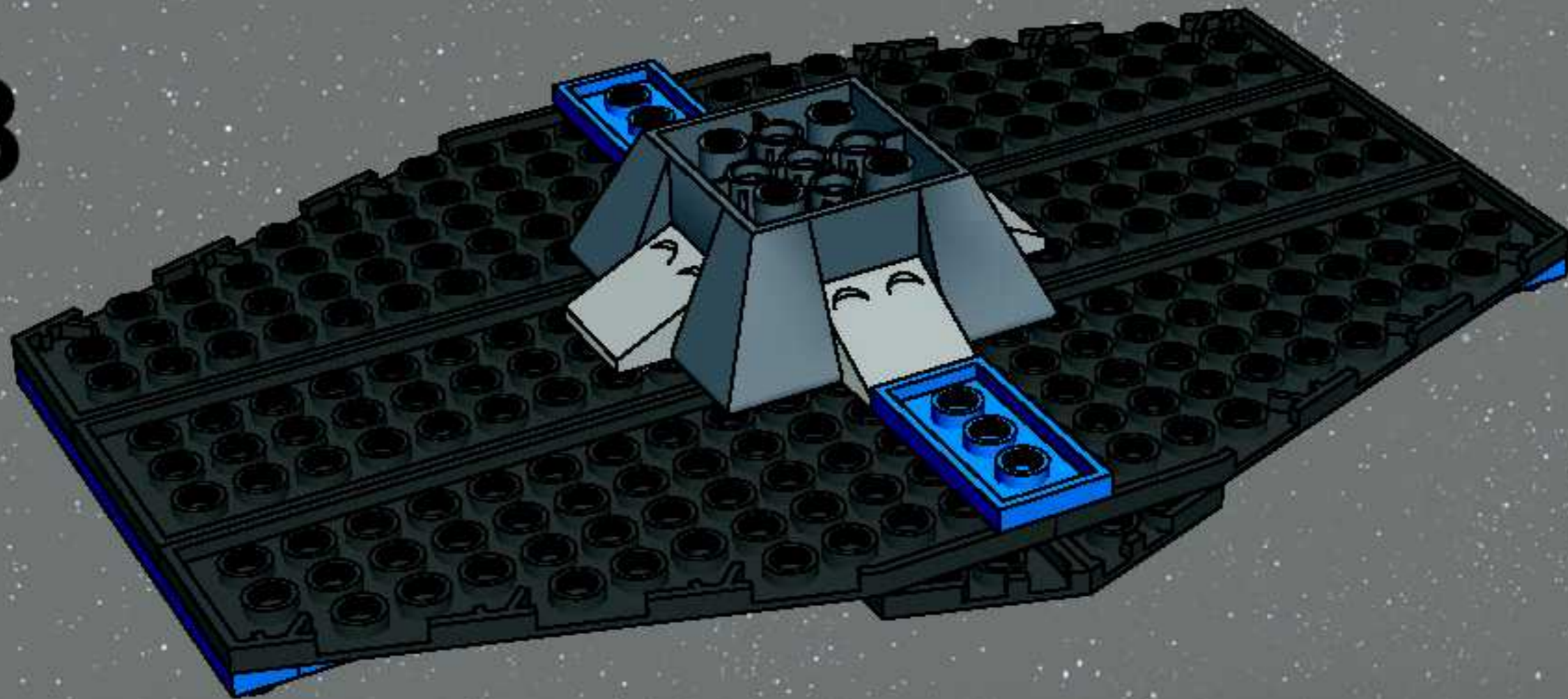

9



2x

10

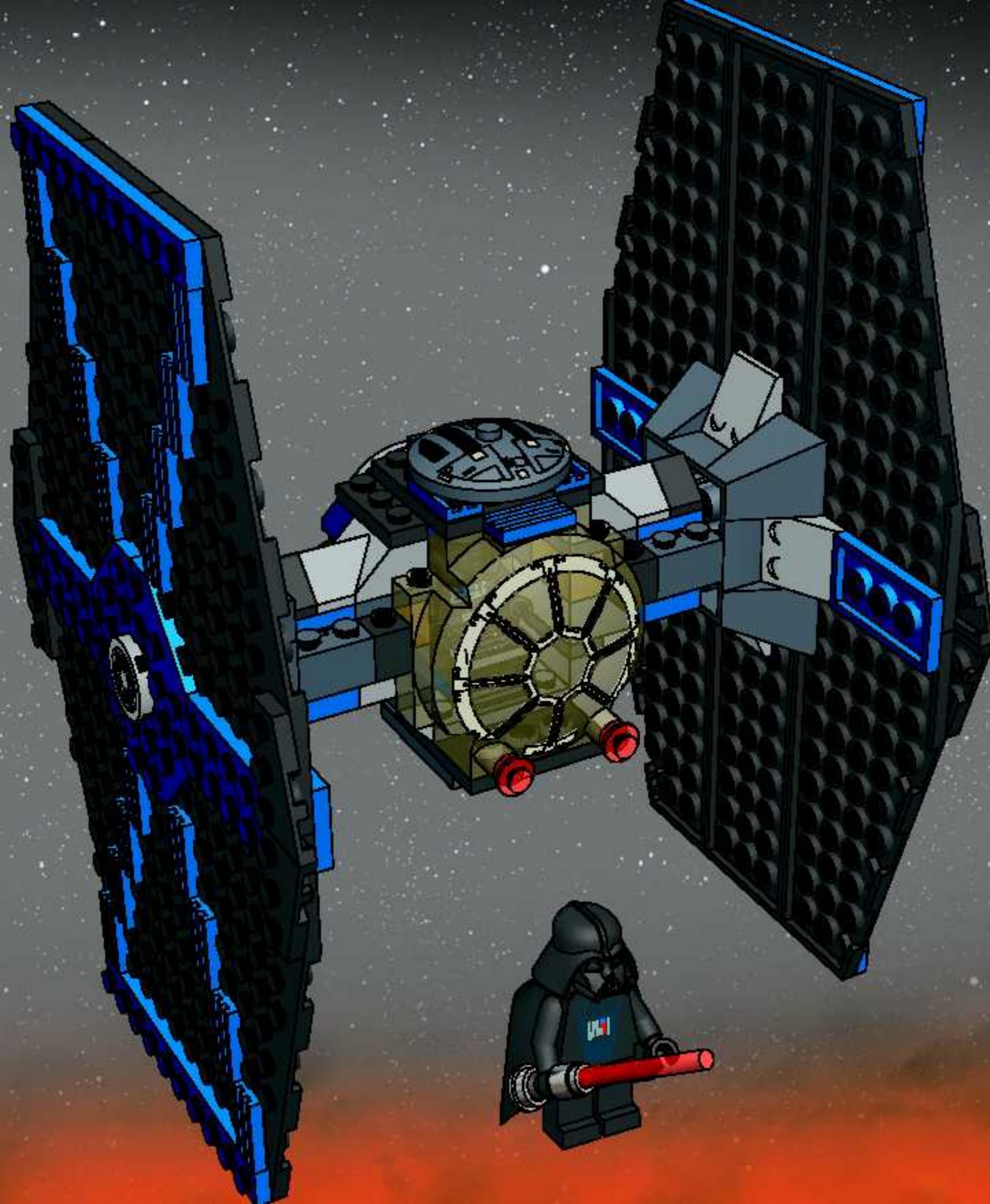



STAR WAR™



7256
Jedi Starfighter™
and Vulture Droid™

Win! Gagne! Gewinne! 当たります



WIN LEGO® PRODUCTS

We would like to know what you think about our new LEGO® product. If you could help us by answering a few questions you are in with a chance of winning an exciting LEGO prize. It will only take you about 3 minutes! Log on to the web address below for further instructions.

We would really like to hear what you think about your new LEGO product. If you'd like to help us, go to the web address below for further instructions.



Estimado usuario LEGO®

Al contestar algunas preguntas en Inglés, francés, alemán o japonés, en el sitio www.acnielsen.aim.dk/lego, podrás participar en el sorteo de algunos valiosos premios LEGO®.



純粋でレゴ®製品が当たります

私たちは、皆さんが興味あるレゴ®製品についてどんな感想をお持ちか、知りたいと思っています。質問に答えて、新しいレゴ®製品の企画に役立ってください。アンケートの回答には、ほんの少しだけしかかかりません！詳しくは、以下のウェブアドレスまでアクセスしてください。



GAGNE DES PRODUITS LEGO®

Nous aimerions savoir ce que tu penses de ton nouveau produit LEGO®. Si tu veux bien nous aider en répondant à quelques questions, tu recevras peut-être bientôt un fantastique prix LEGO. Et cela ne te prendra que 3 minutes environ ! Tu obtiendras davantage d'informations en visitant le site Internet indiqué ci-dessous.

Nous aimerions savoir ce que tu penses de ton nouveau produit LEGO. Si tu souhaites nous aider, rends-toi à l'adresse Internet ci-dessous où tu trouveras des instructions supplémentaires.



Caro Consumidor da LEGO®

Ao responder a algumas perguntas em Inglês, Francês, Alemão ou Japonês no endereço www.acnielsen.aim.dk/lego irá participar num concurso para ganhar valiosos prémios de LEGO®.



GEWINNE LEGO® PRODUKTE

Wir sind sehr an deiner Meinung über dein neues LEGO® Produkt interessiert. Wenn du uns den Gefallen tust und ein paar Fragen beantwortest, kannst du einen tollen LEGO Preis gewinnen. Das Ganze dauert nur etwa 3 Minuten! Gehe einfach zu der unten angegebenen Webadresse - dort findest du weitere Informationen.

Wir möchten gerne wissen, was Sie von Ihrem neuen LEGO Produkt halten. Wenn Sie uns helfen möchten, besuchen Sie bitte die u.a. Website, auf der Sie alles Weitere erfahren.



Kedves Új LEGO® Vásárló

Ha ellátogat az www.acnielsen.aim.dk/lego honlapra és ott angol, francia, német vagy japán nyelven megválaszolsz néhány kérdést, akkor részt veszel egy versenyben, amelyben értékes LEGO® díjakat nyerhetsz.

www.acnielsen.aim.dk/LEGO



LEGO STAR WARS™

The Videogame

April 2005



RATING PENDING
RP
Visit www.esrb.org or call
1-800-771-3372 for more info.
CONTENT RATED BY
ESRB

 PlayStation 2

 XBOX

 GAME BOY ADVANCE

 PC CD-ROM



LEGO, the LEGO logo and the Minifigure are trademarks of The LEGO Group. © 2004 The LEGO Group. © 2004 LucasFilm Entertainment Company Ltd. or LucasFilm Ltd. & ® or TM as indicated. All rights reserved. Microsoft, Xbox and the Xbox logos are either registered trademarks or trademarks of Microsoft Corporation in the U.S. and/or in other countries and are used under license from Microsoft. All rights reserved. PS2 and PlayStation are registered trademarks of Sony Computer Entertainment Inc. All rights reserved. GAME BOY ADVANCE IS A TRADEMARK OF NINTENDO. The NVIDIA logo and "The way it's meant to be played" logo are registered trademarks or trademarks of NVIDIA Corporation.

4269486

©2005 The LEGO Group.