

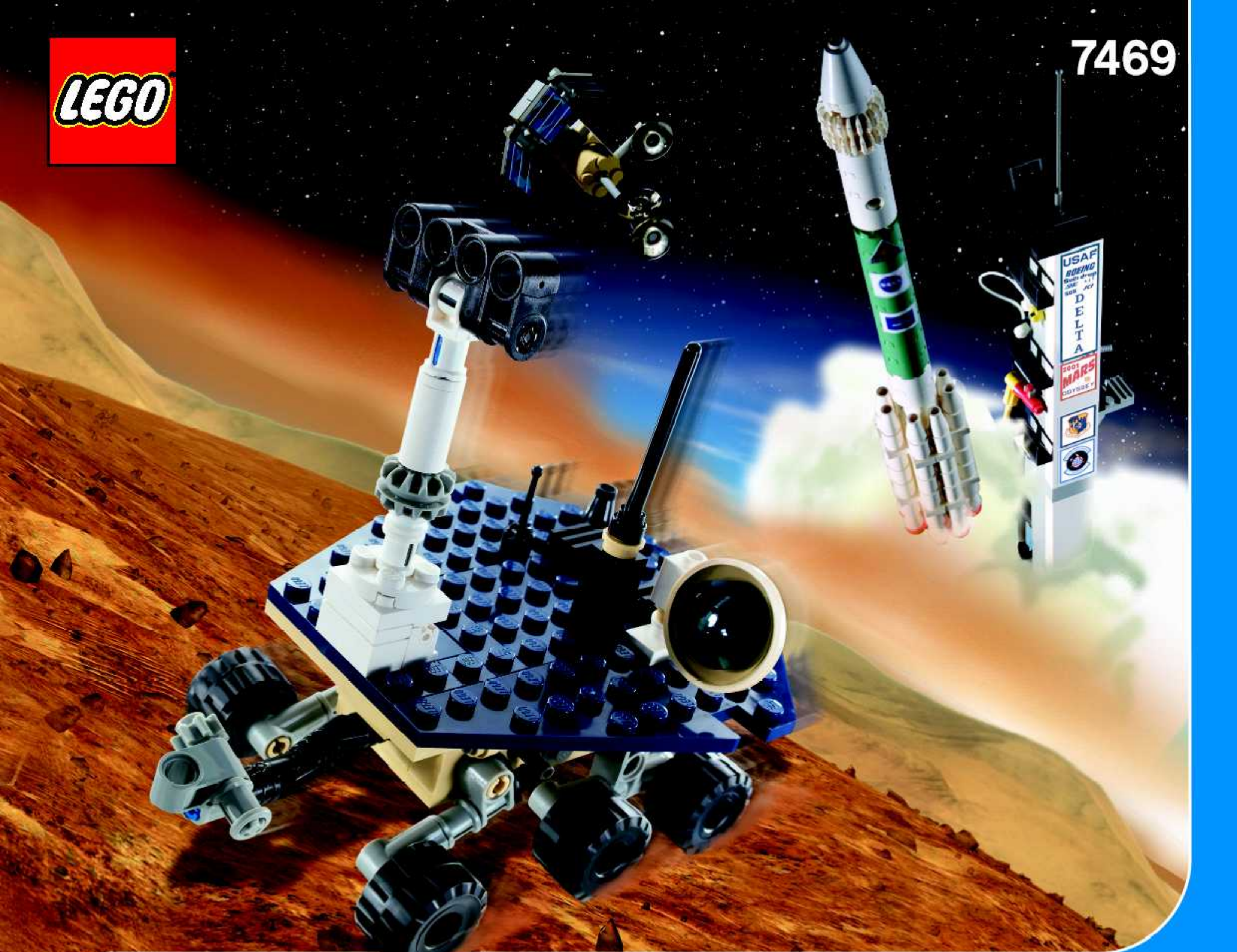

7469



4222673



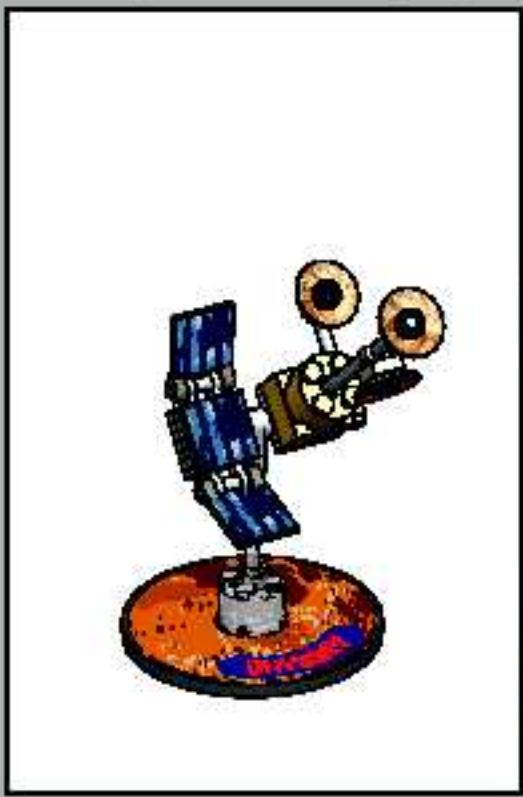

1

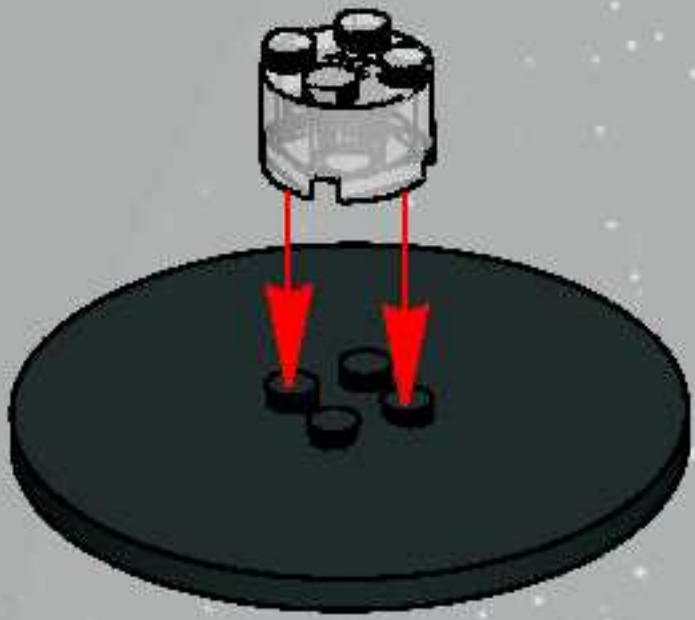

2



3

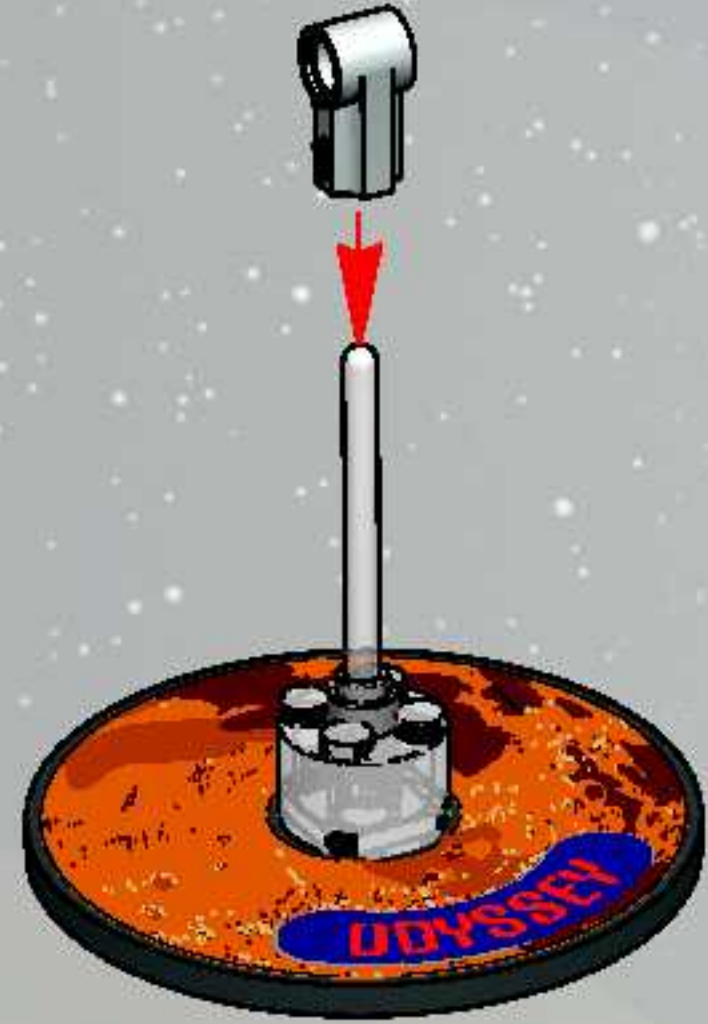

4



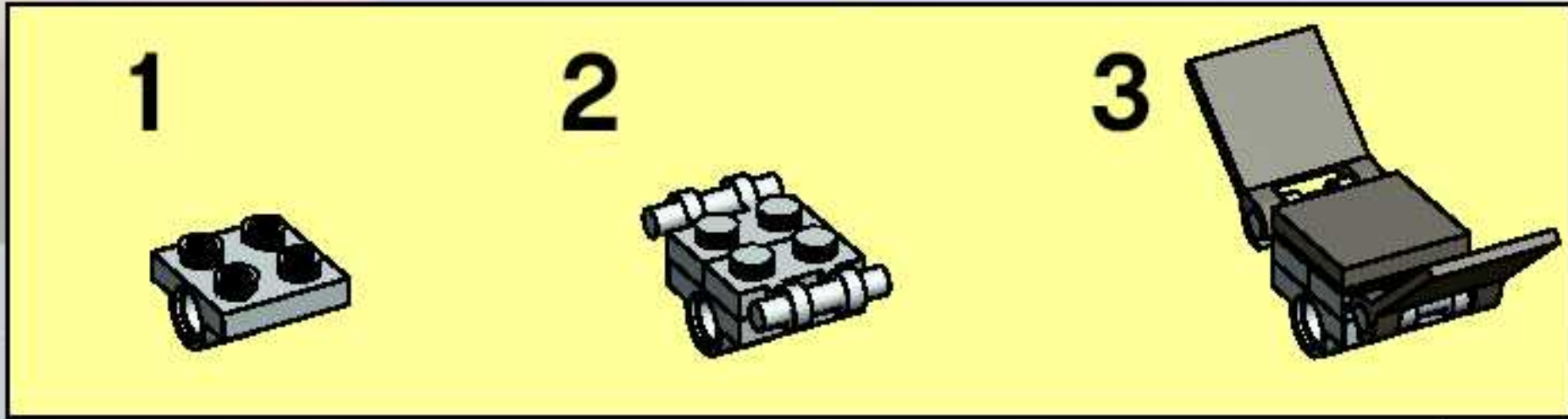

5

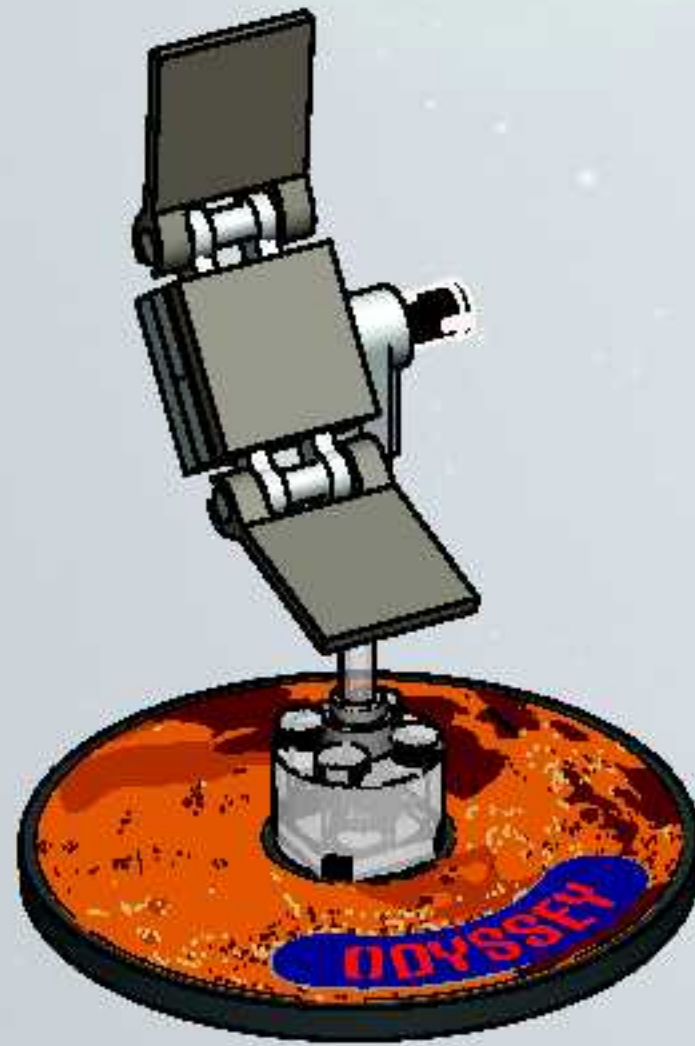

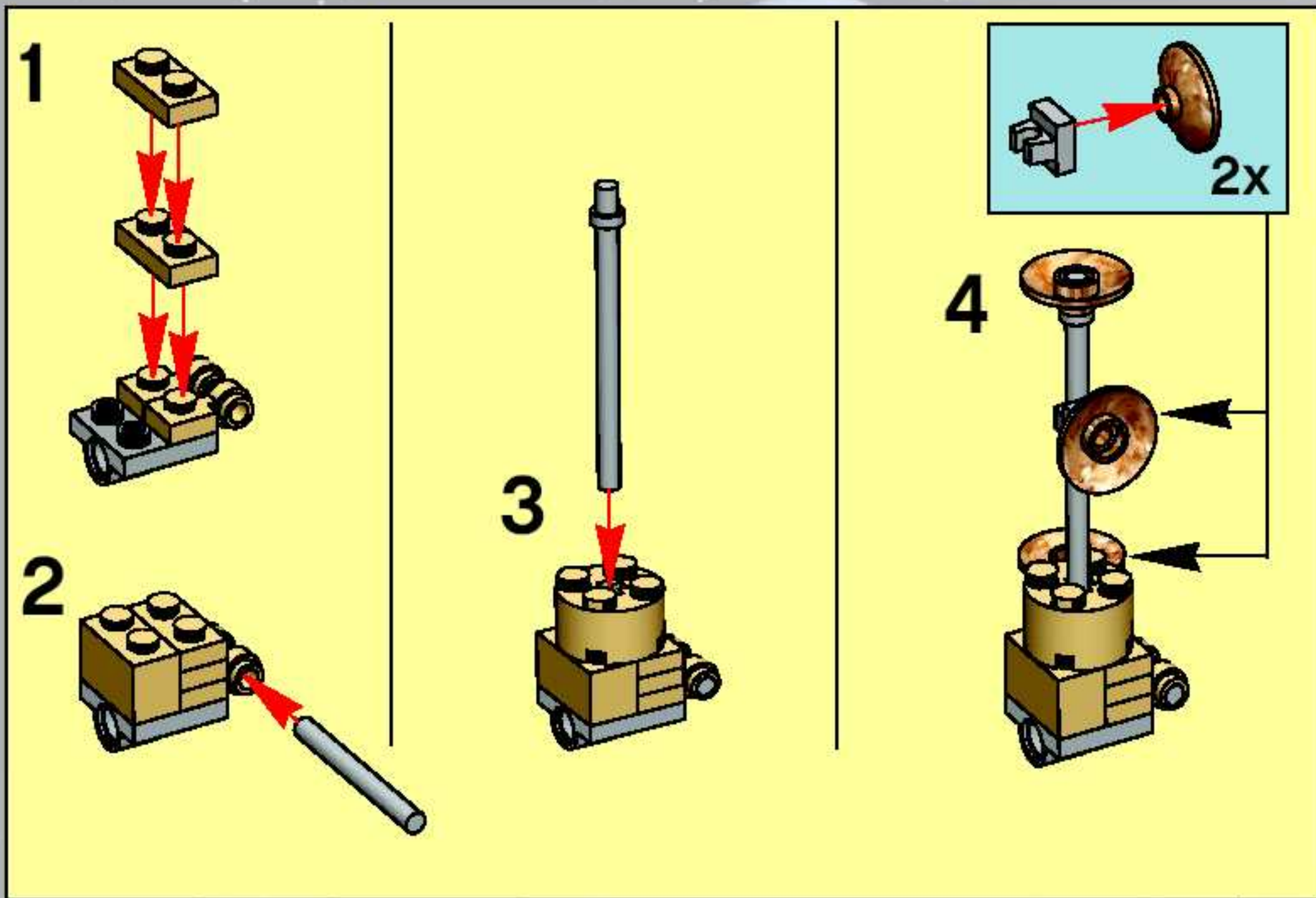

6

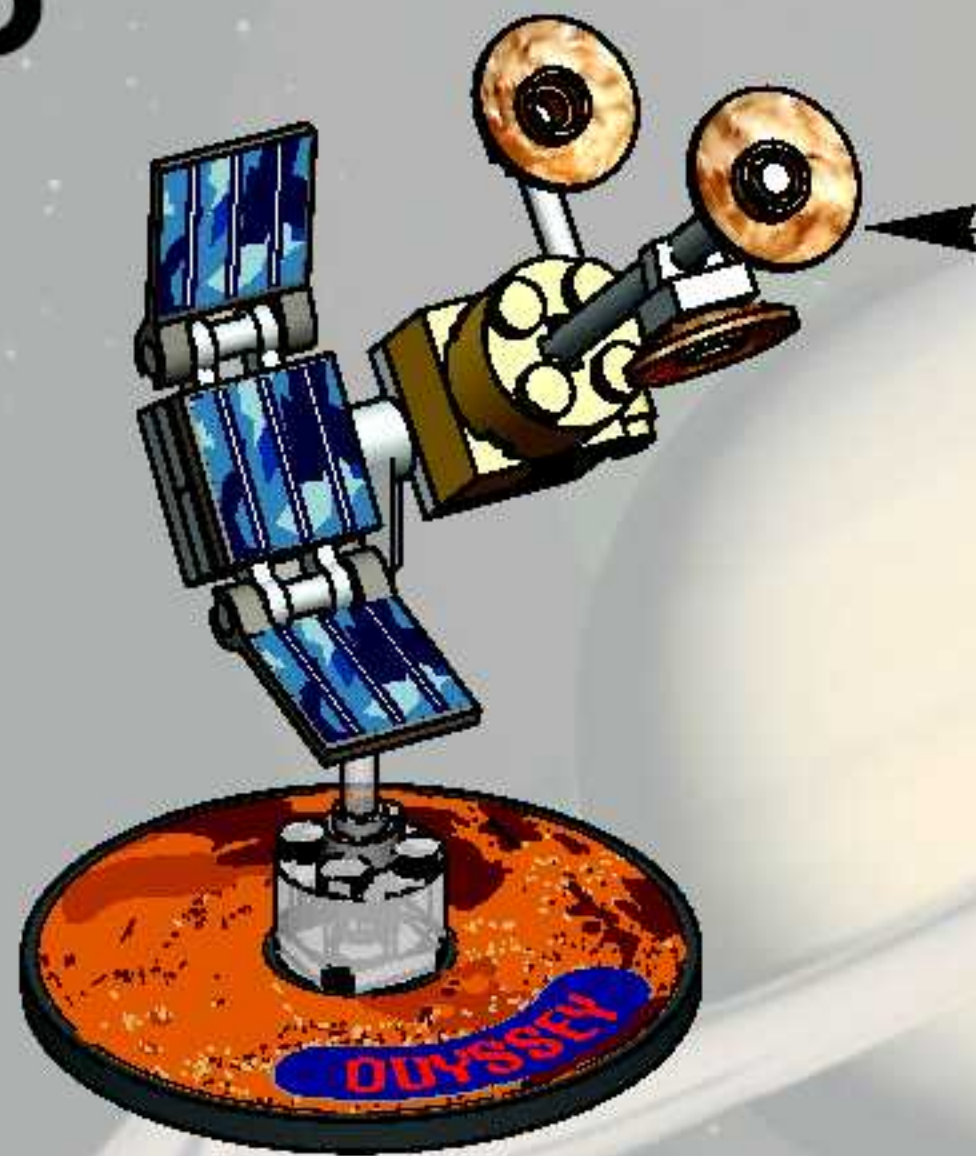

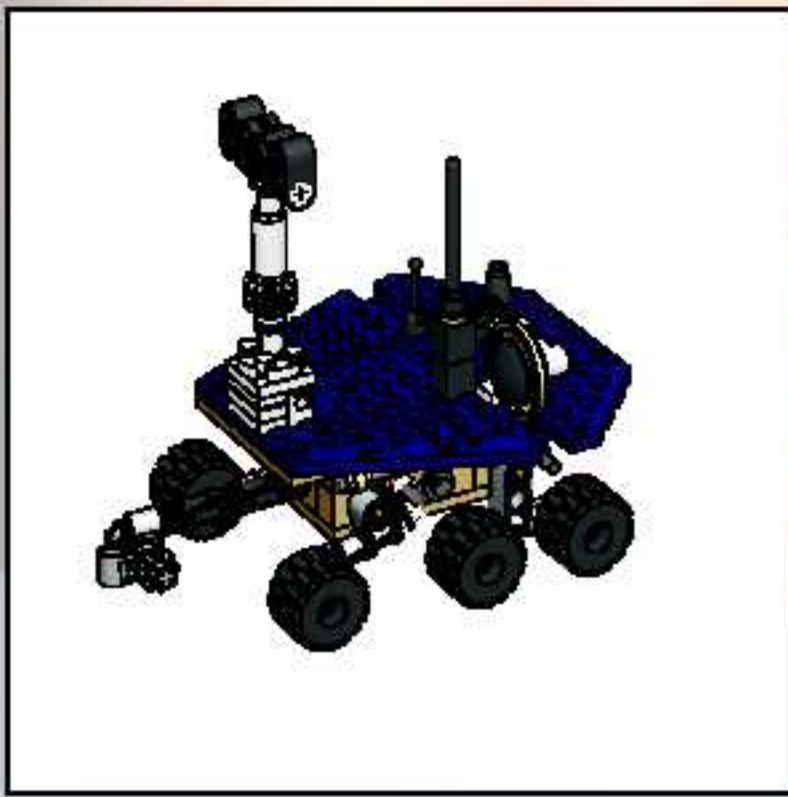

1

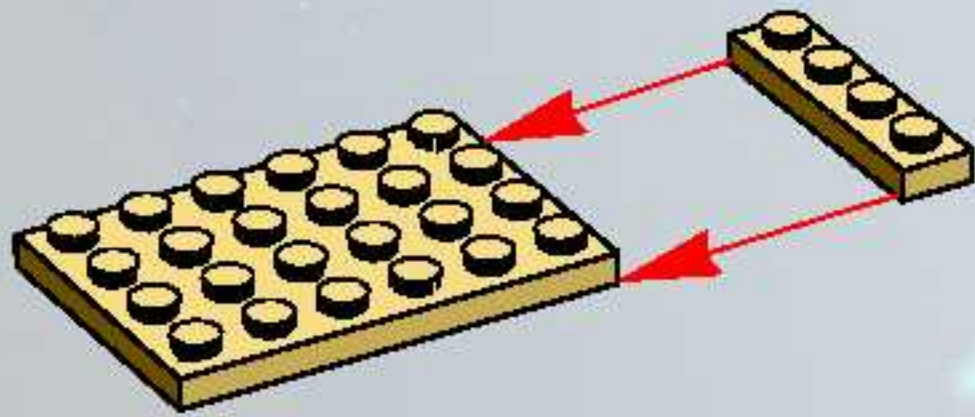

2



3

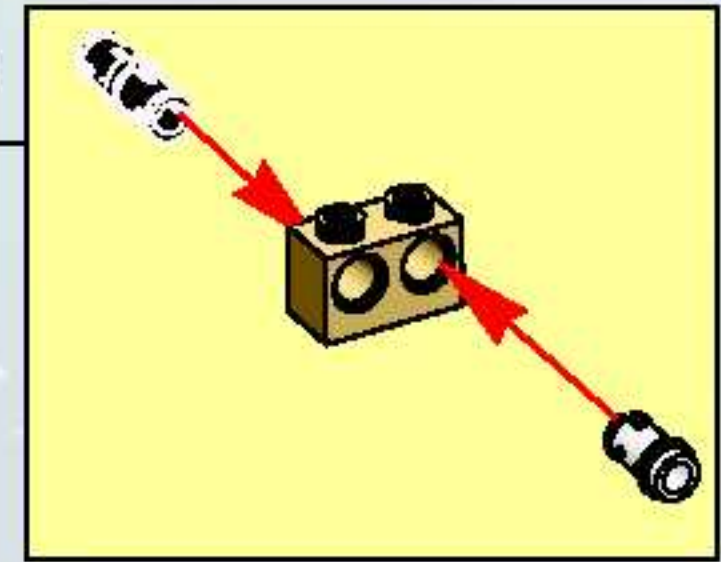
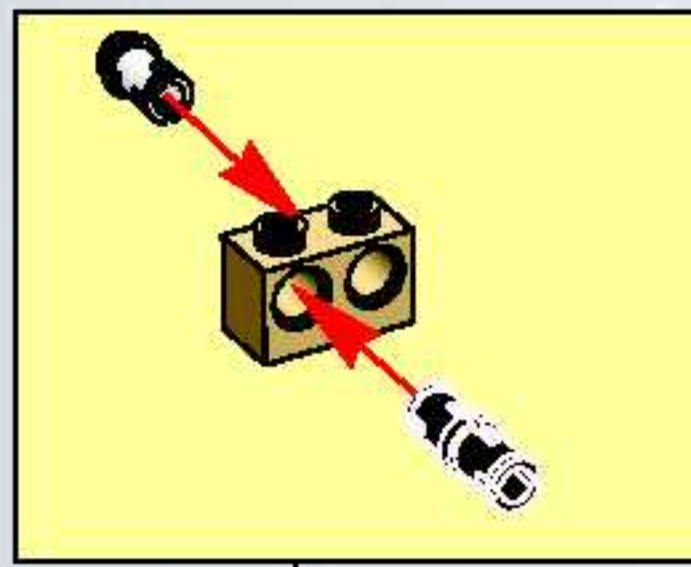

4

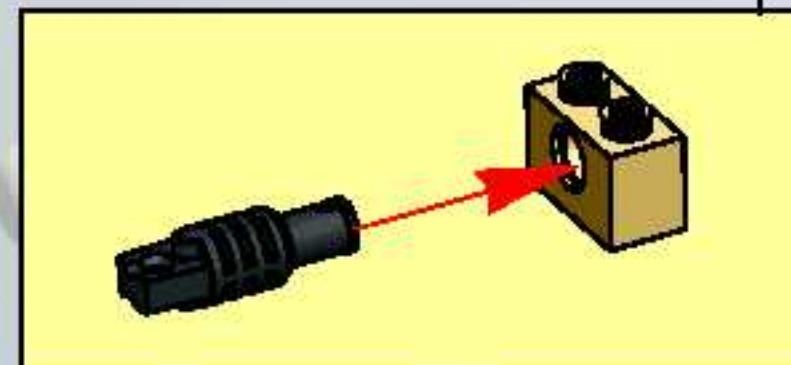
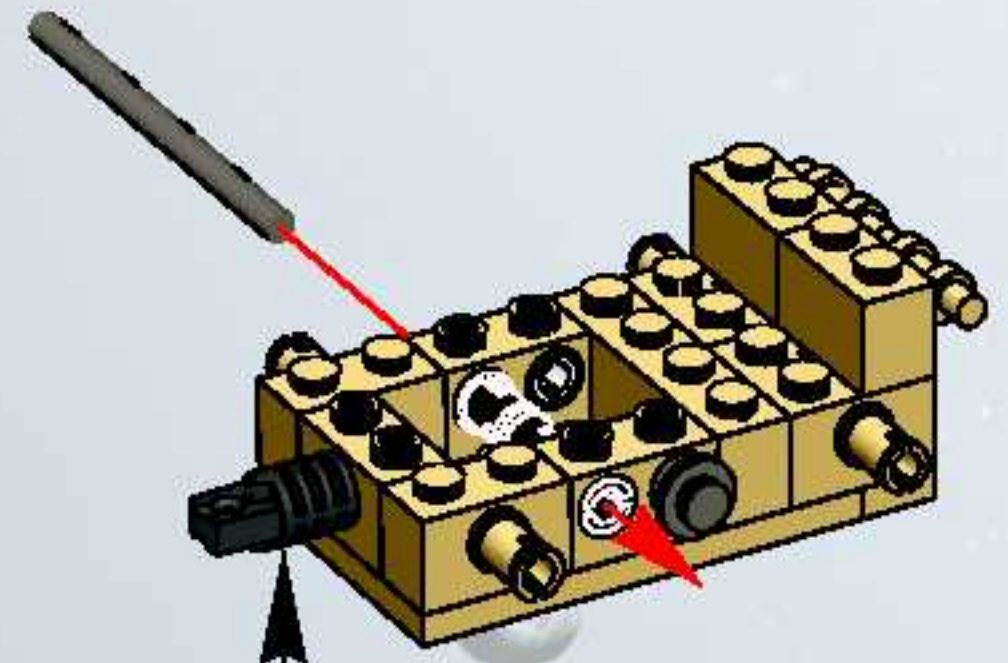

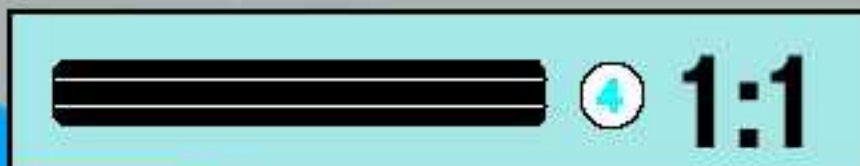
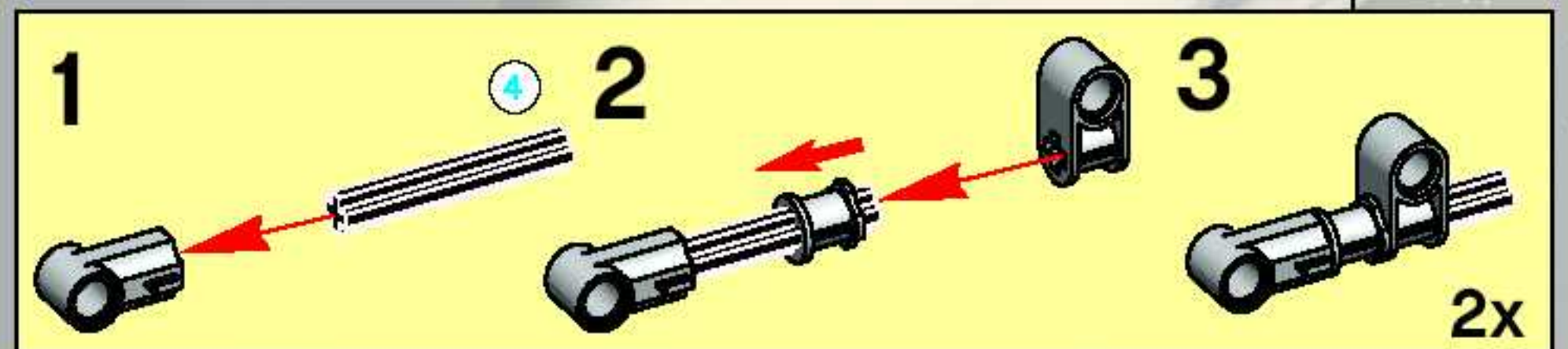
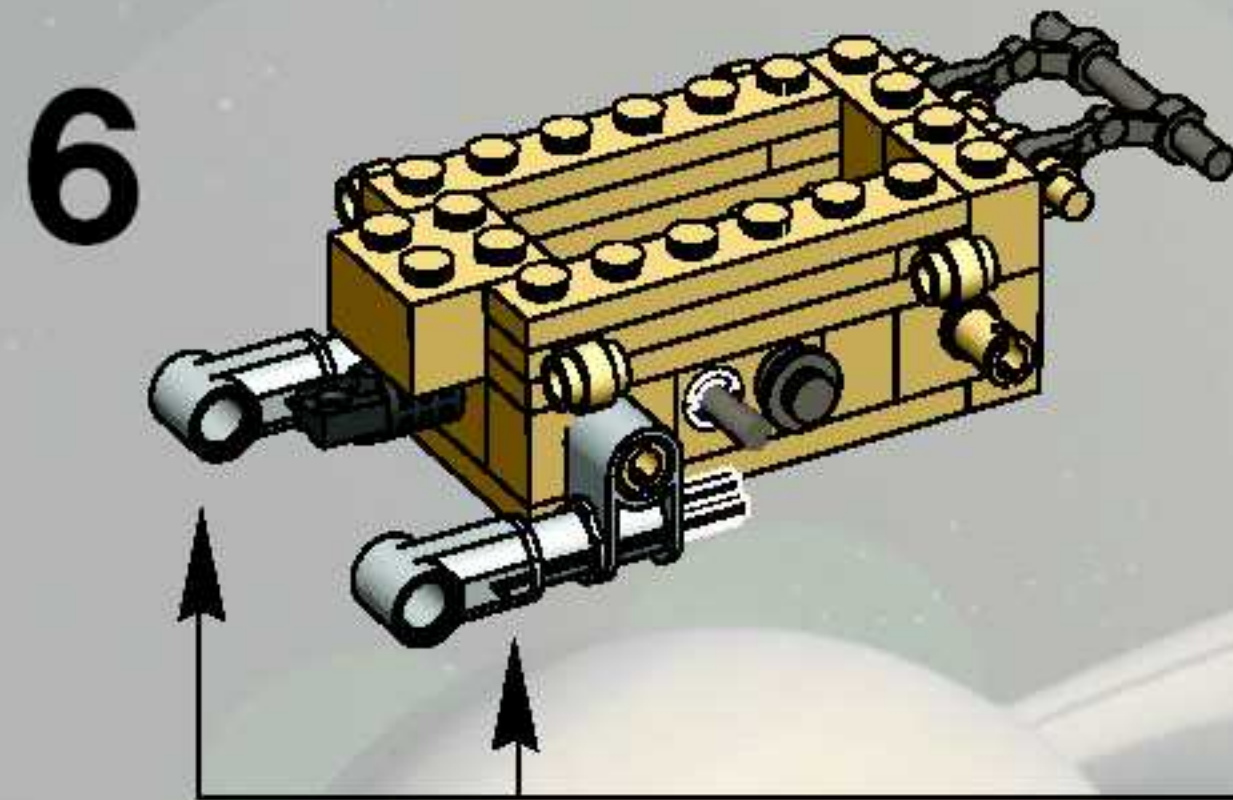
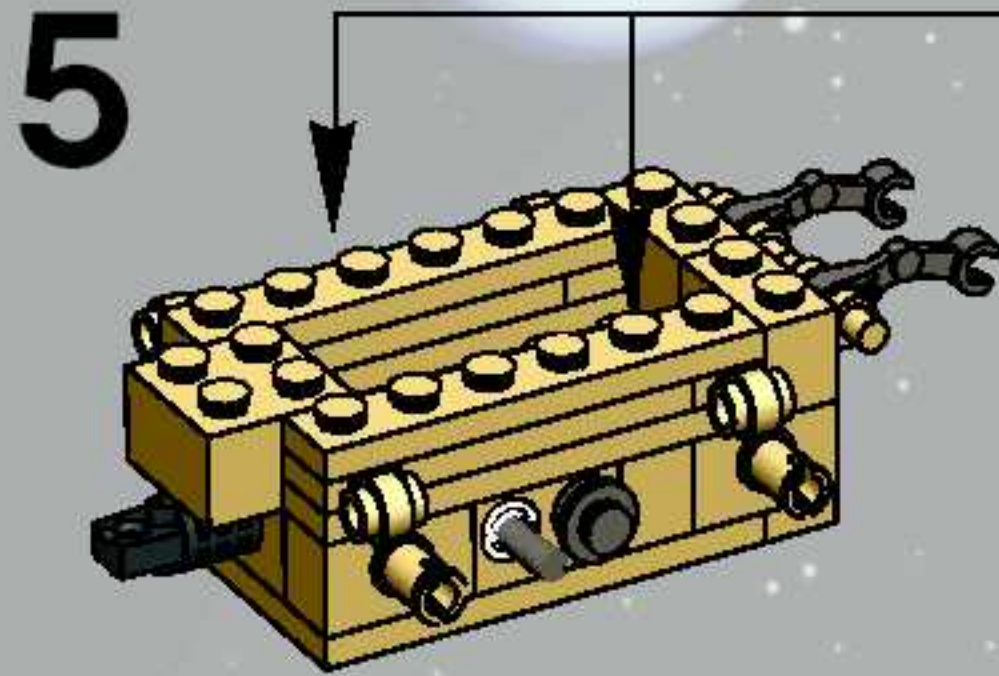
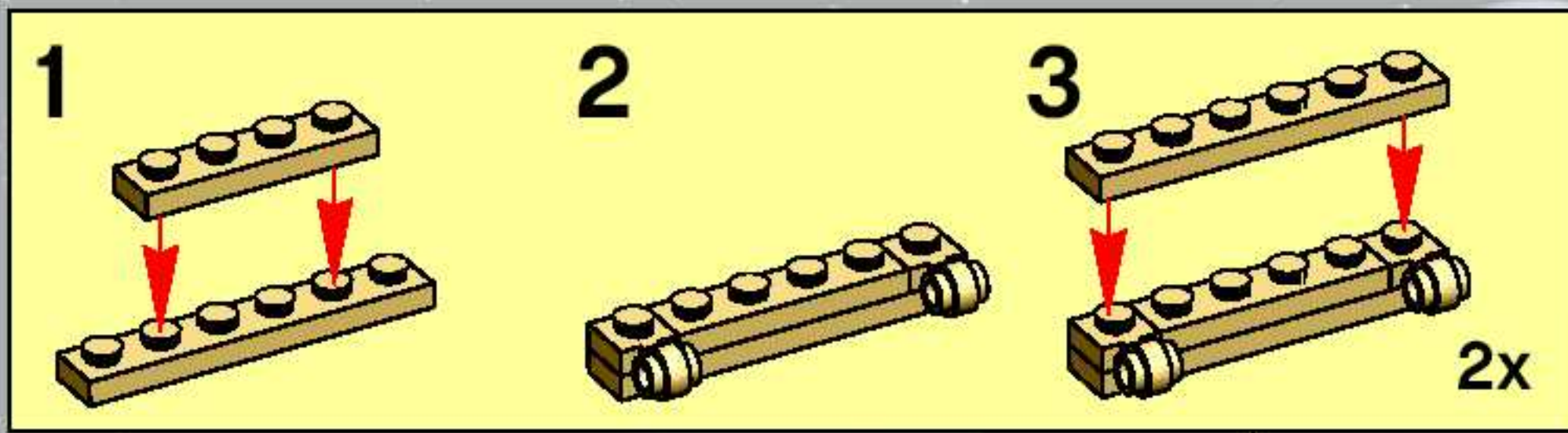

7

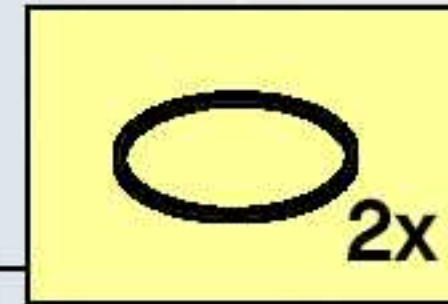
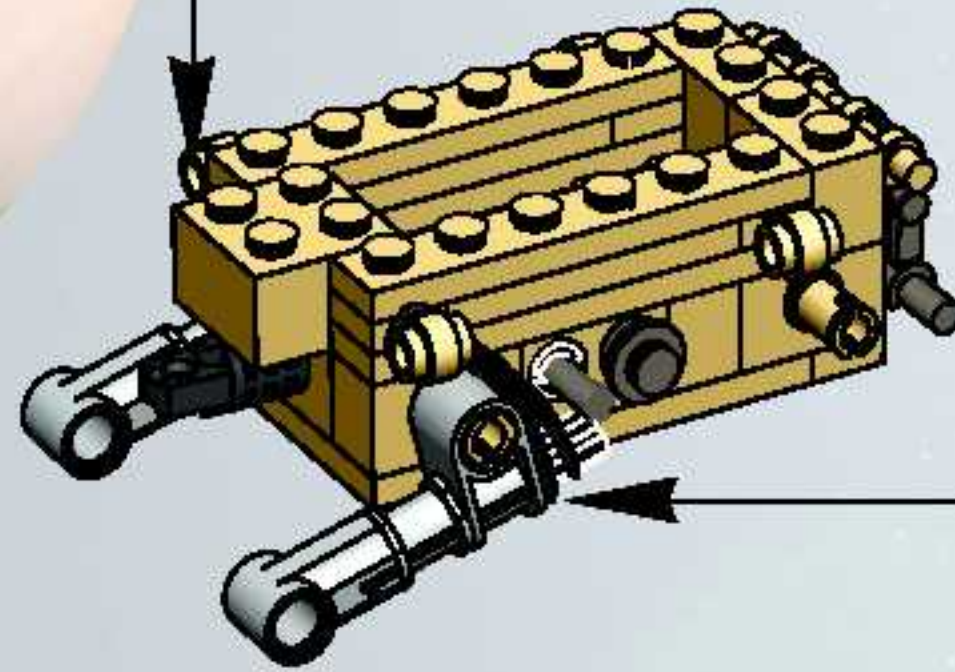
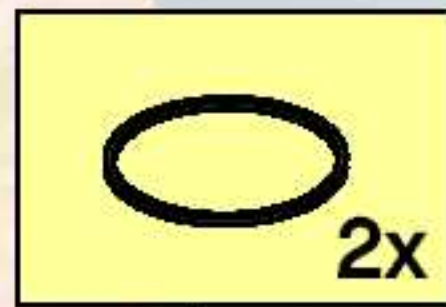

8

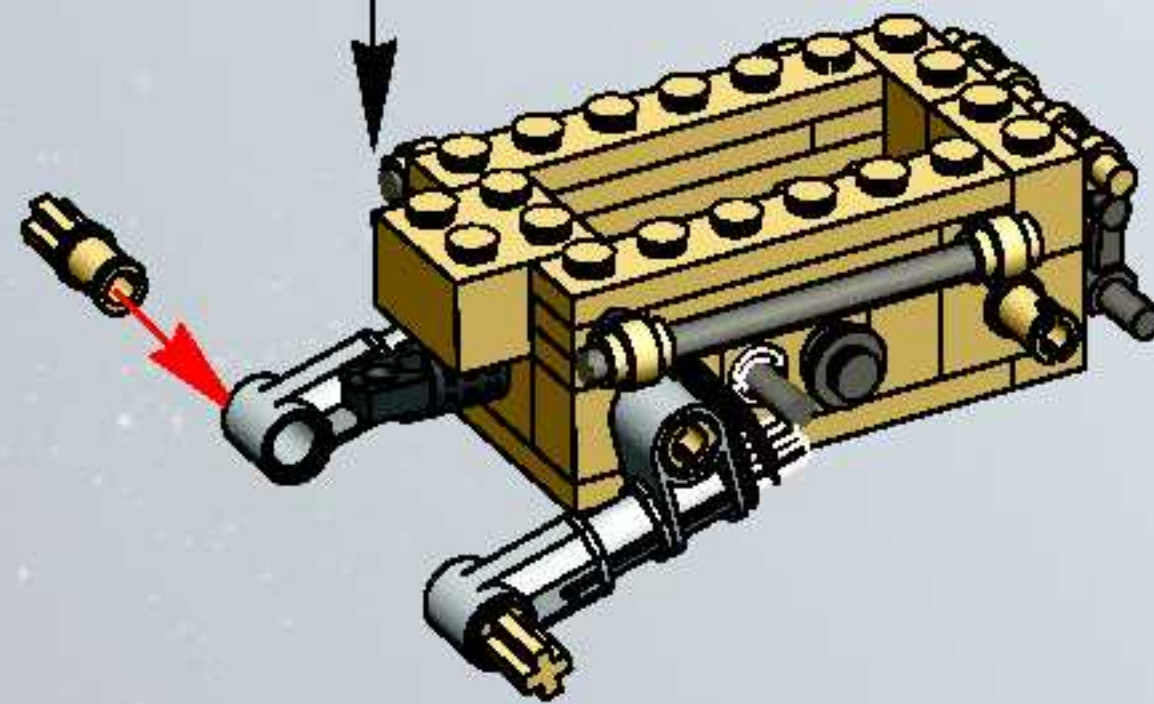
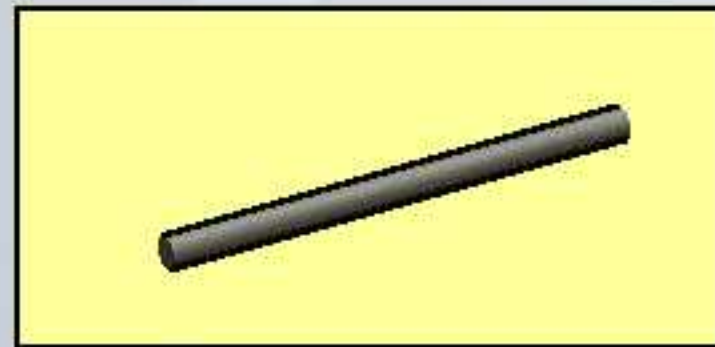

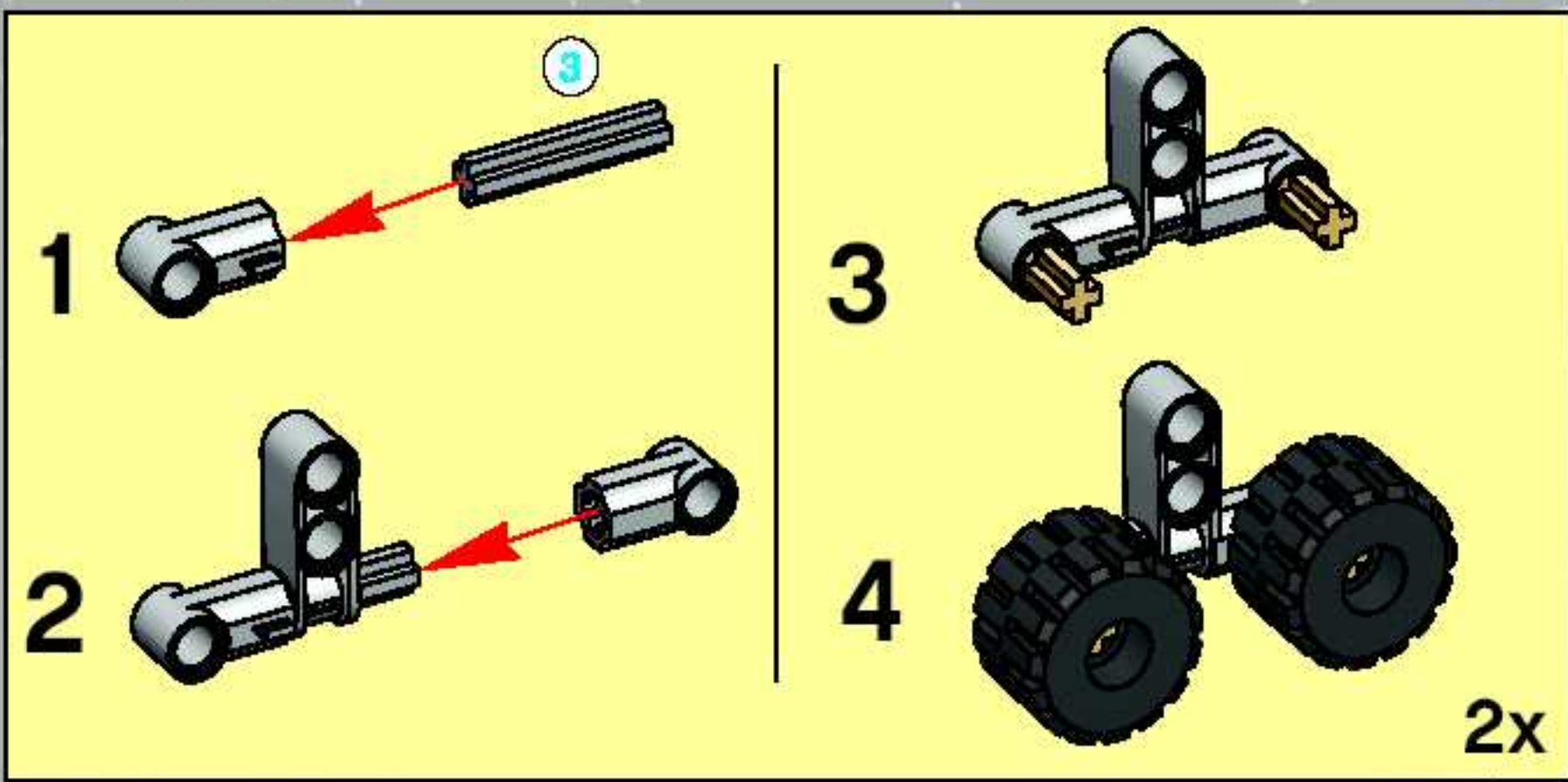

9



10

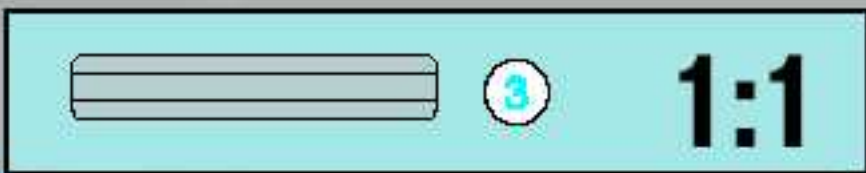
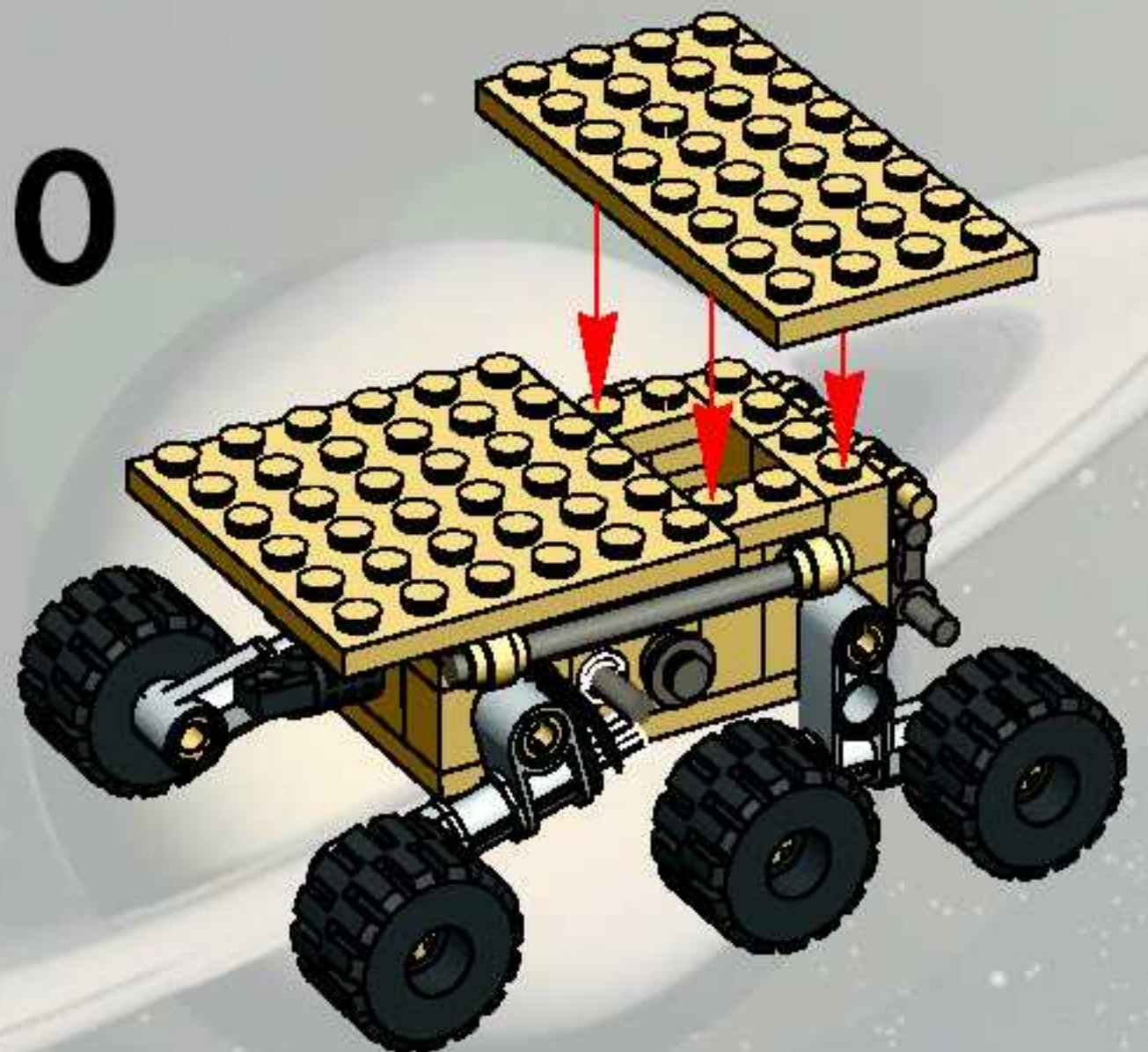

11

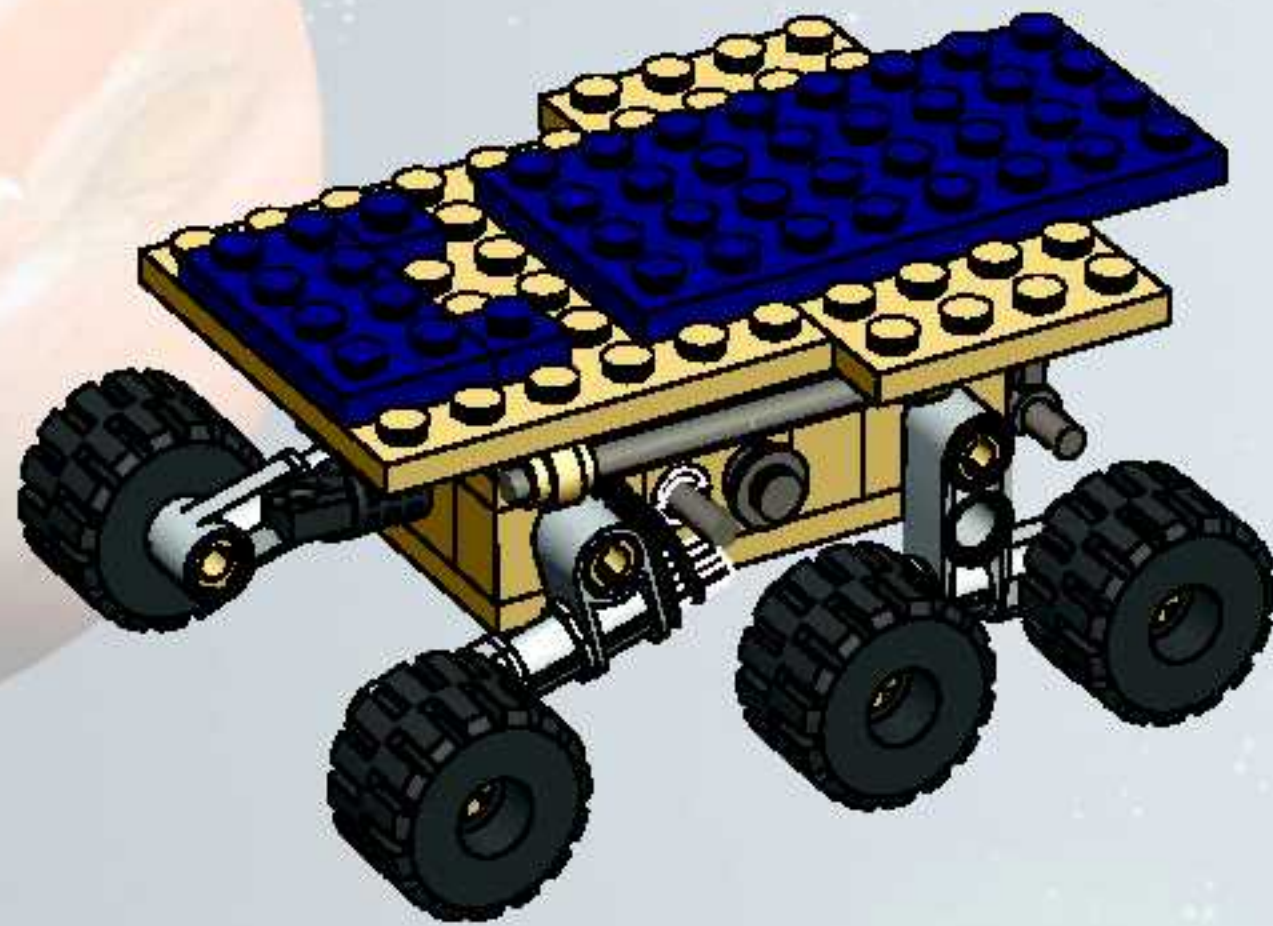

12

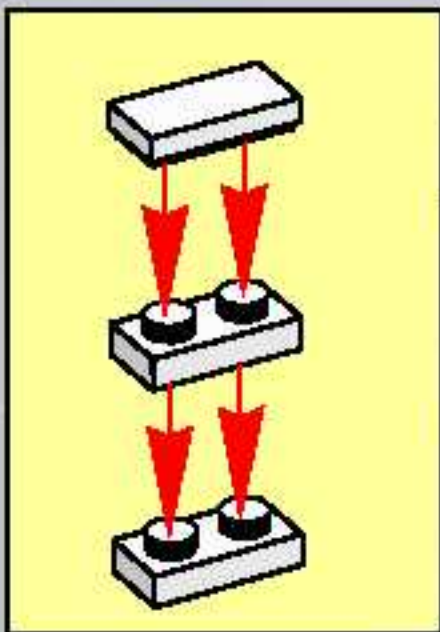
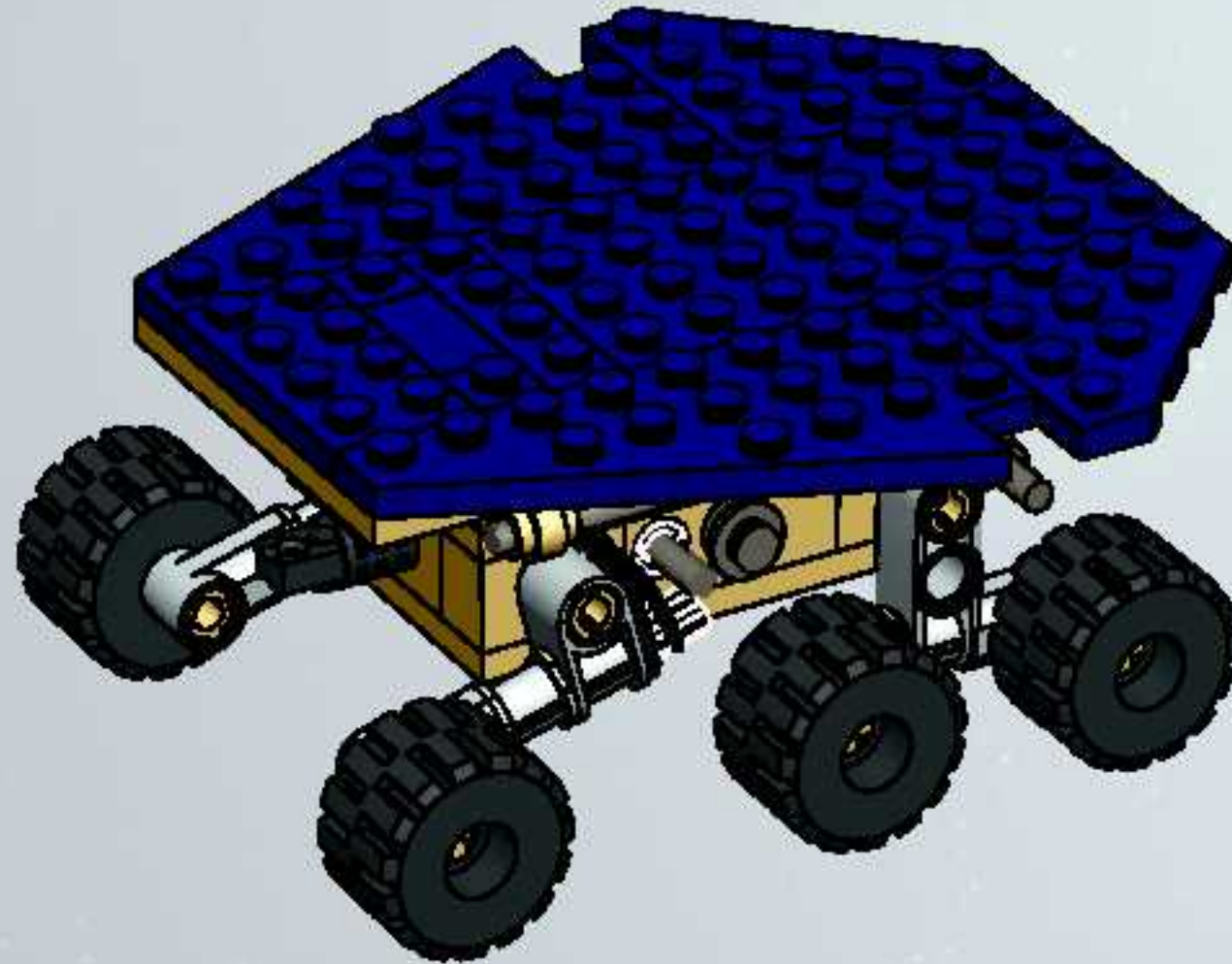

13

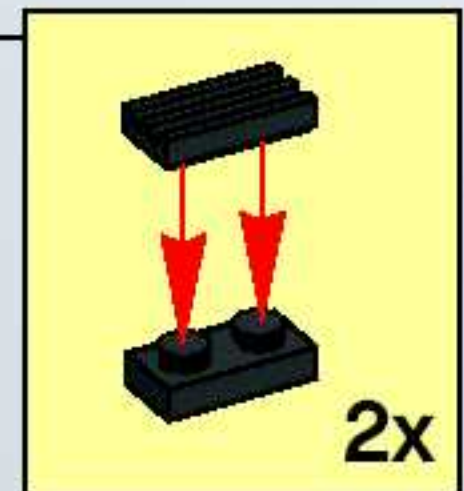
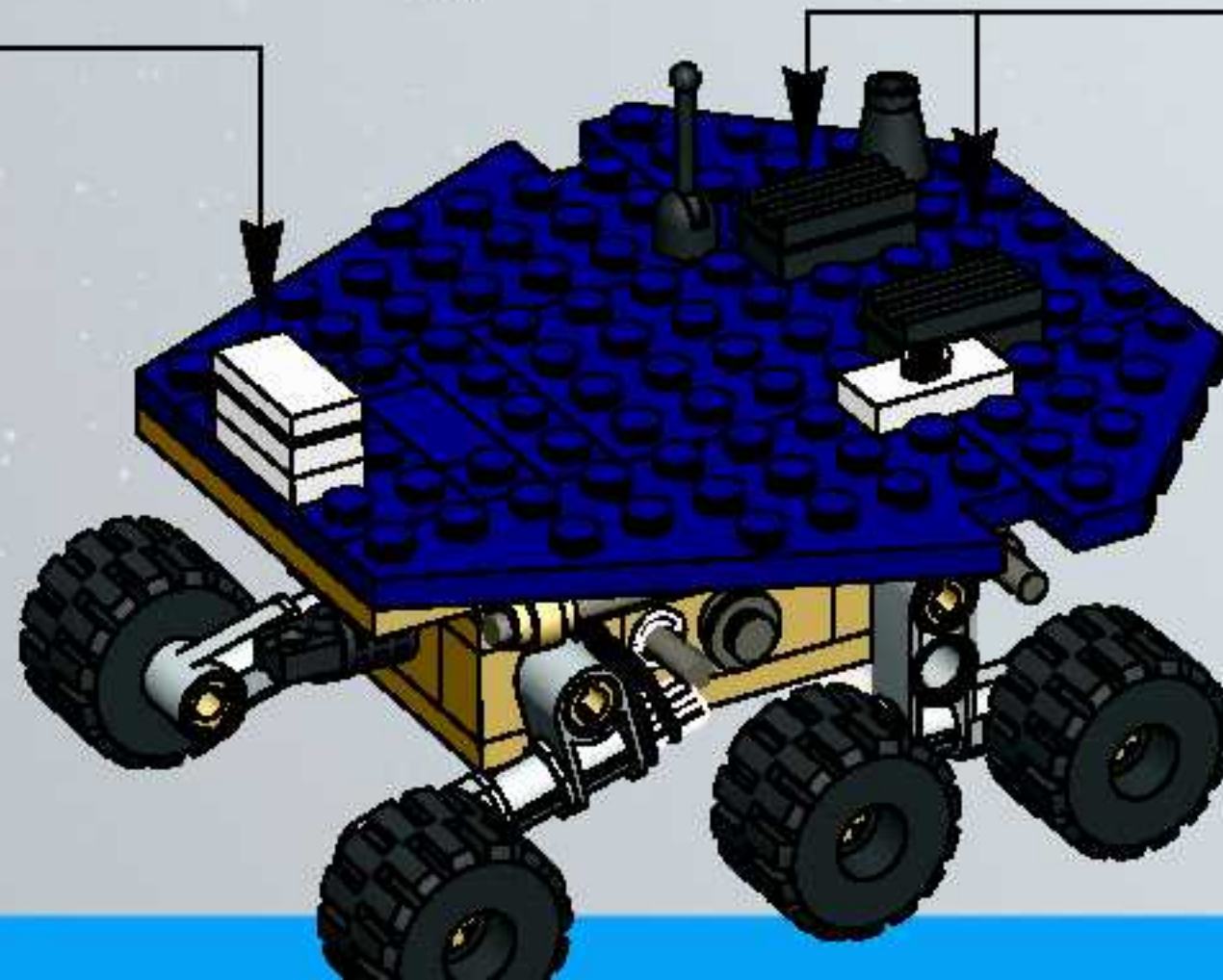

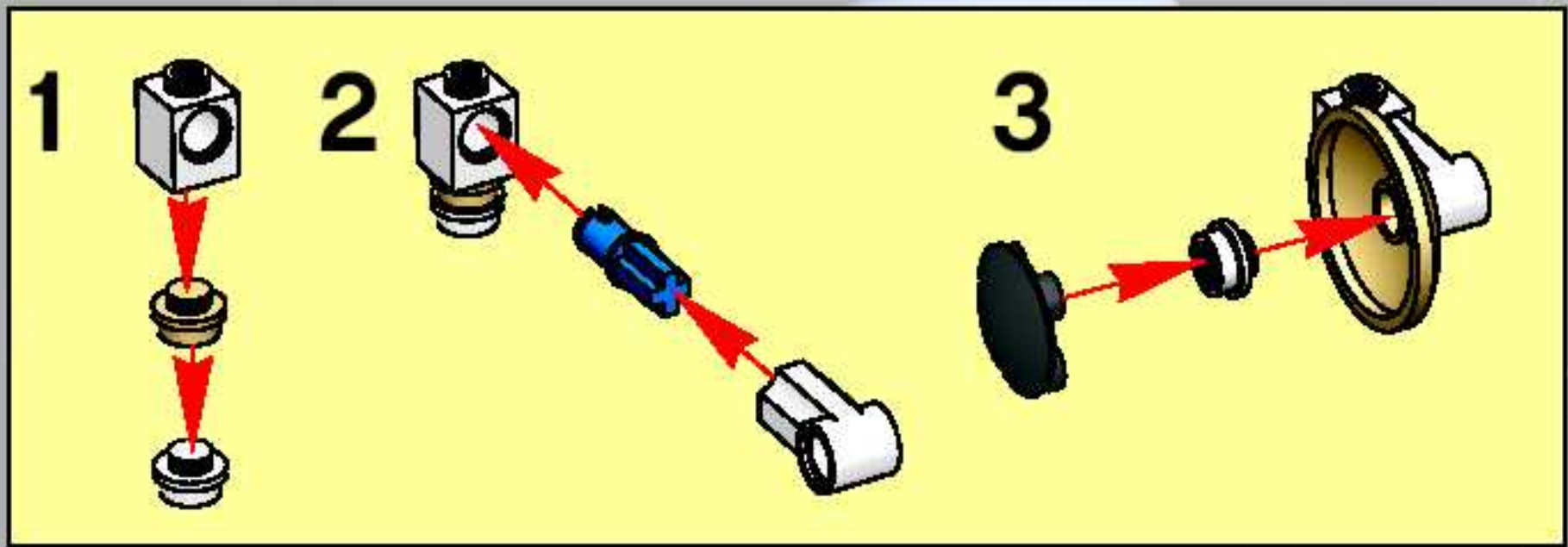

14

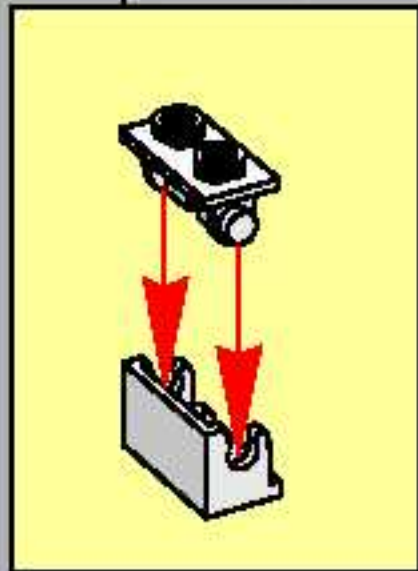
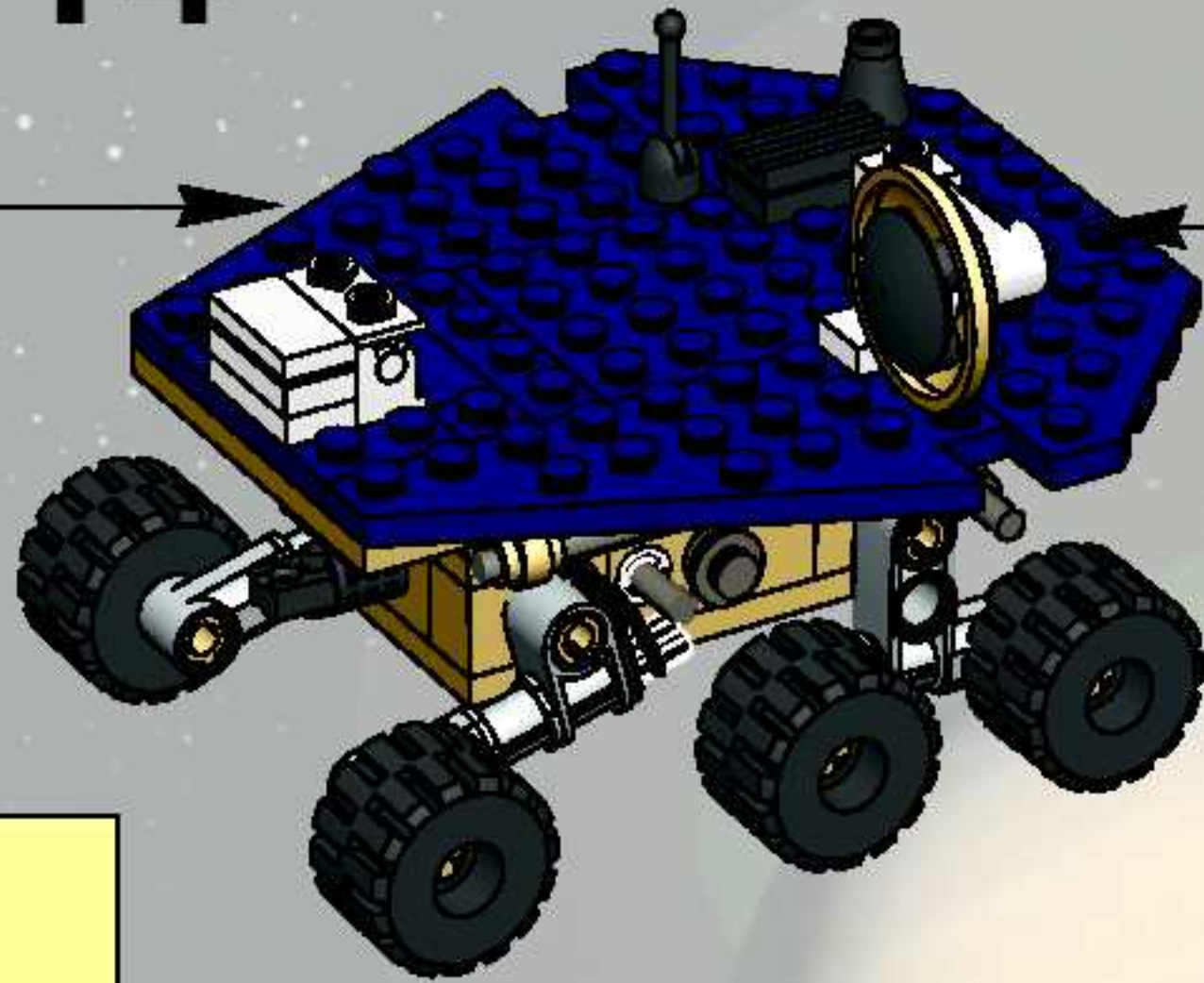

1

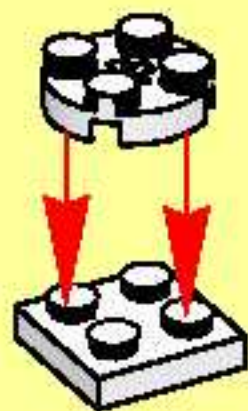

2

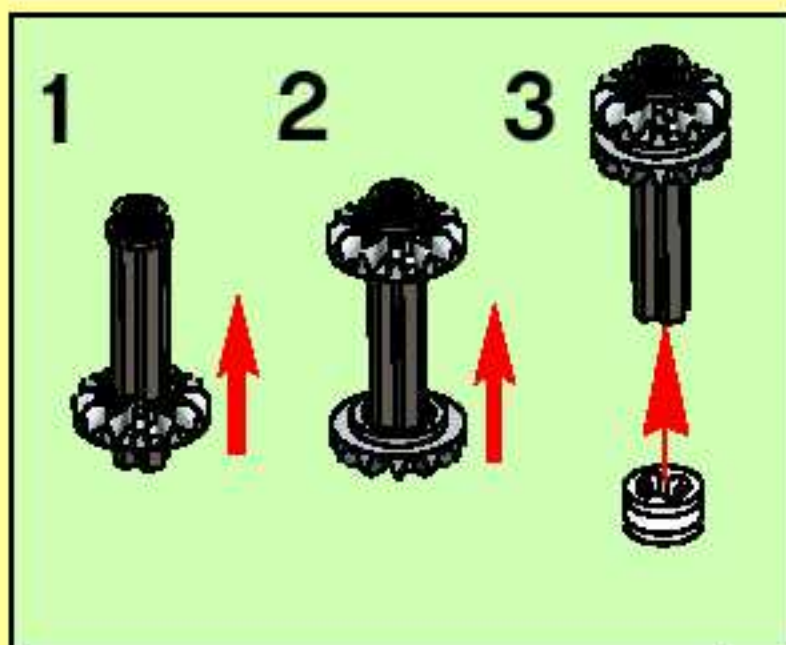

3



4

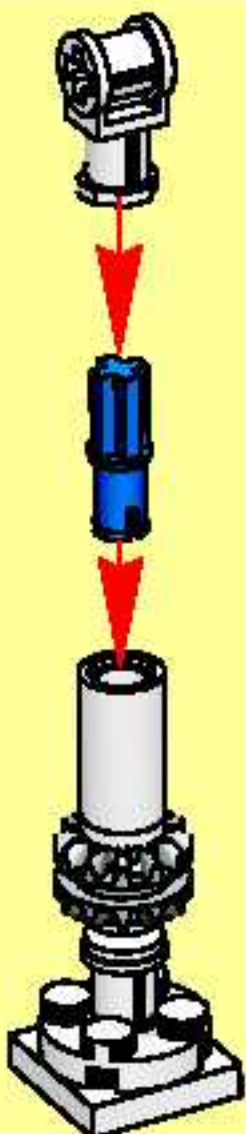

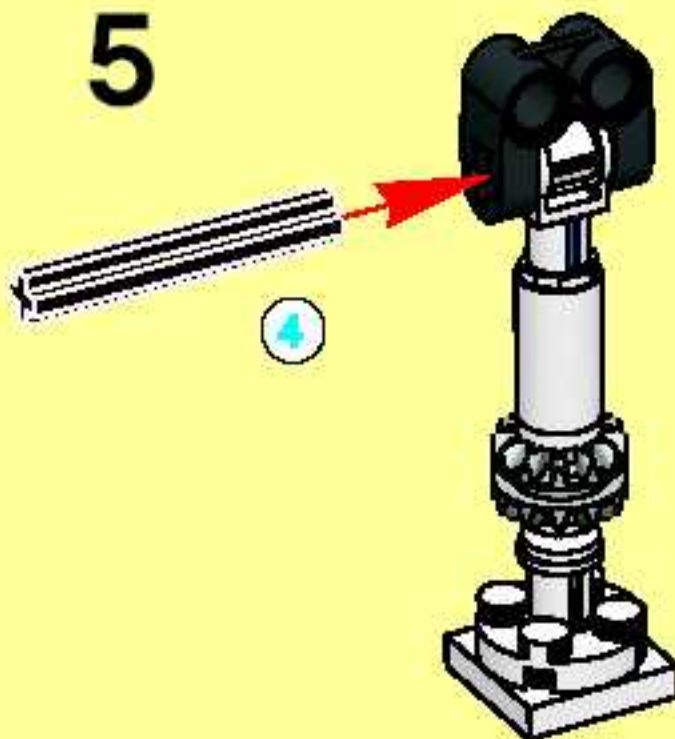

5

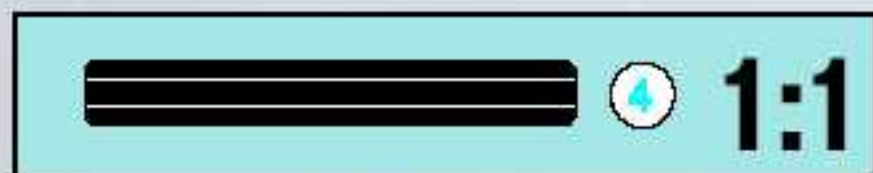
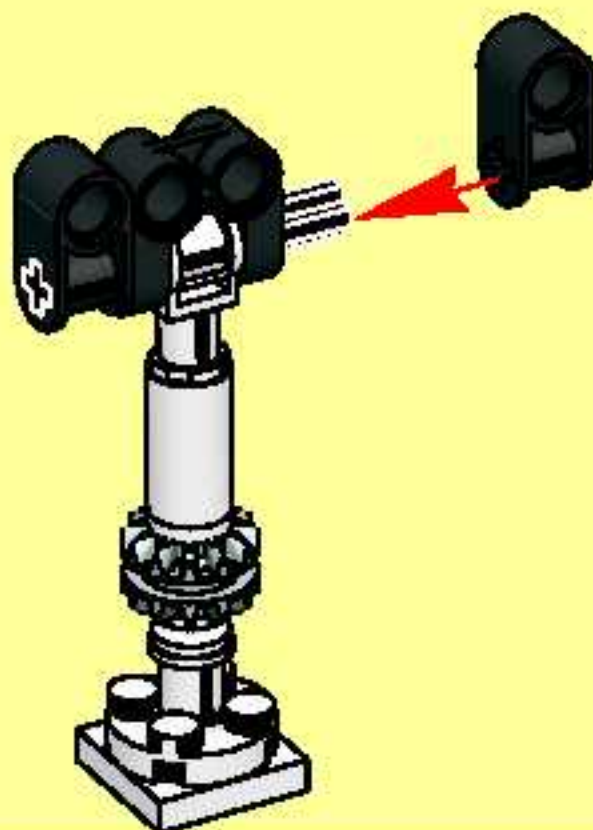

6



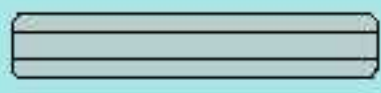

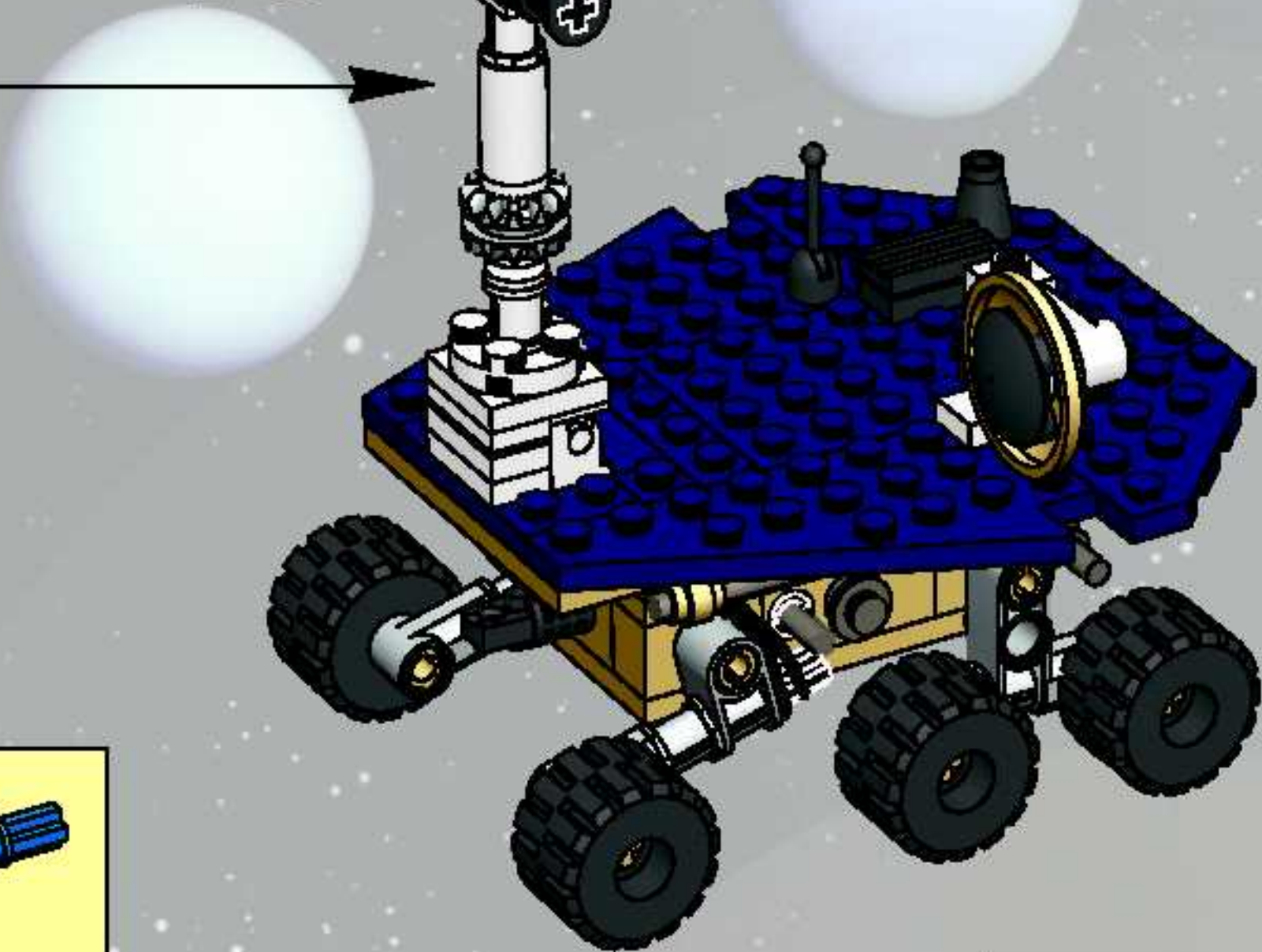

15

  **1:1**





16

1  

2  

3 



1   

2 

1

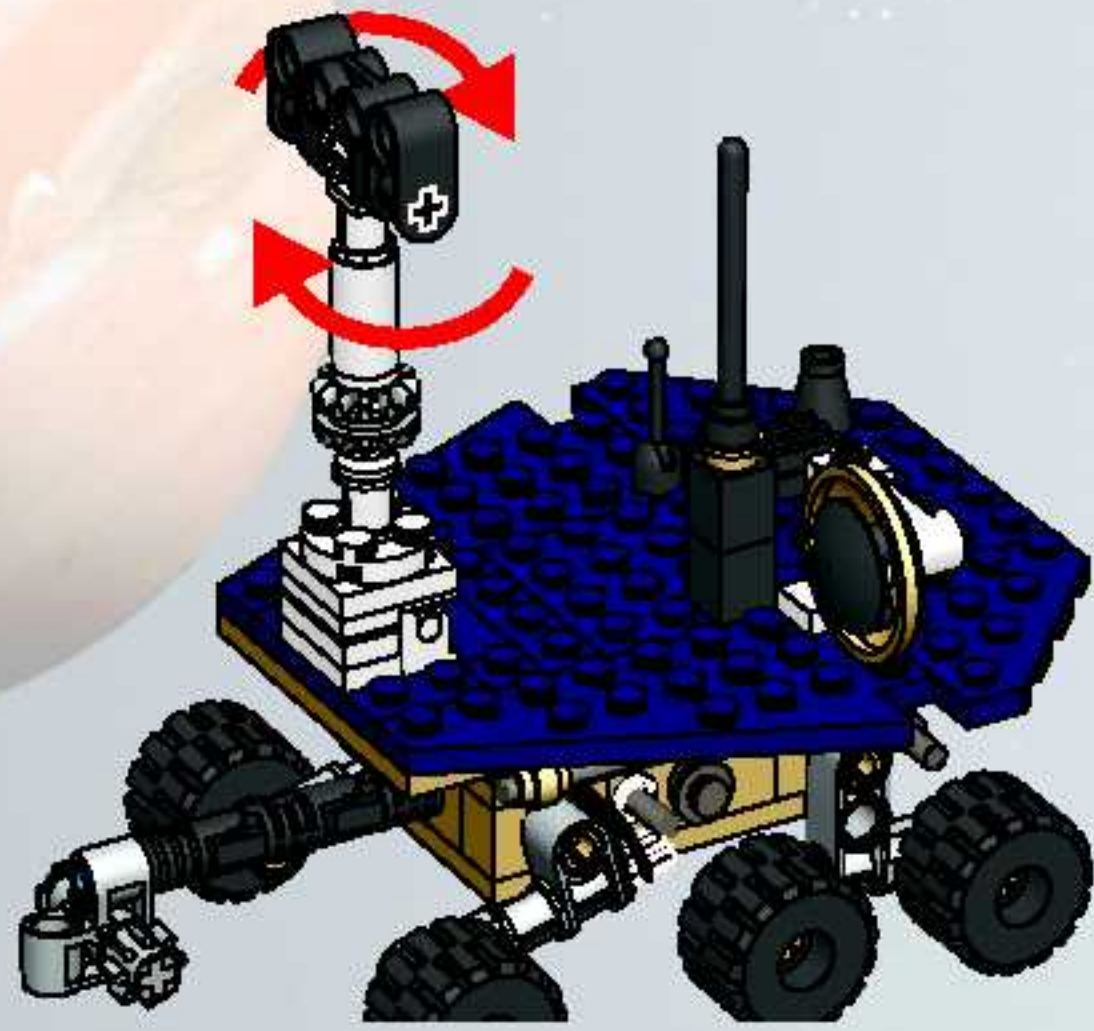

2

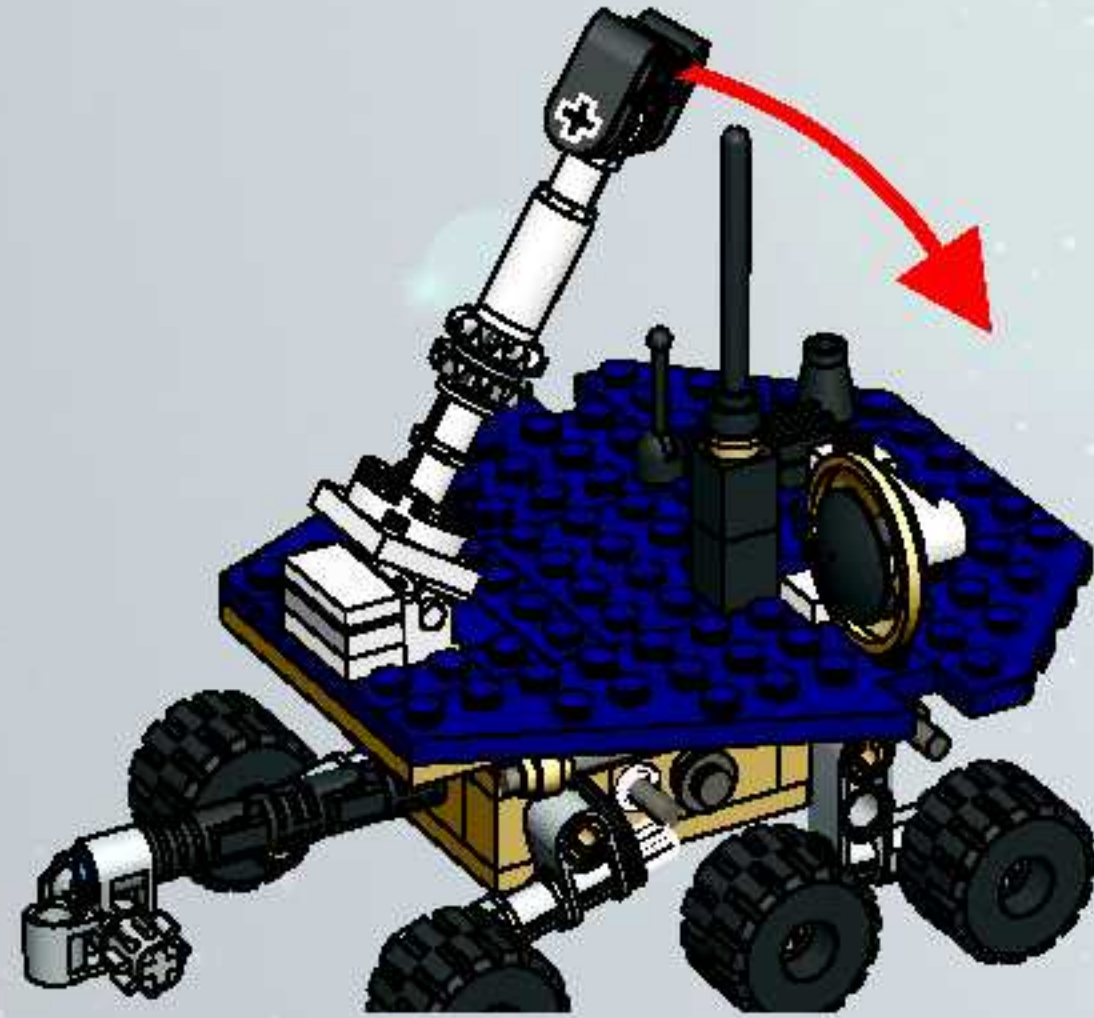

3

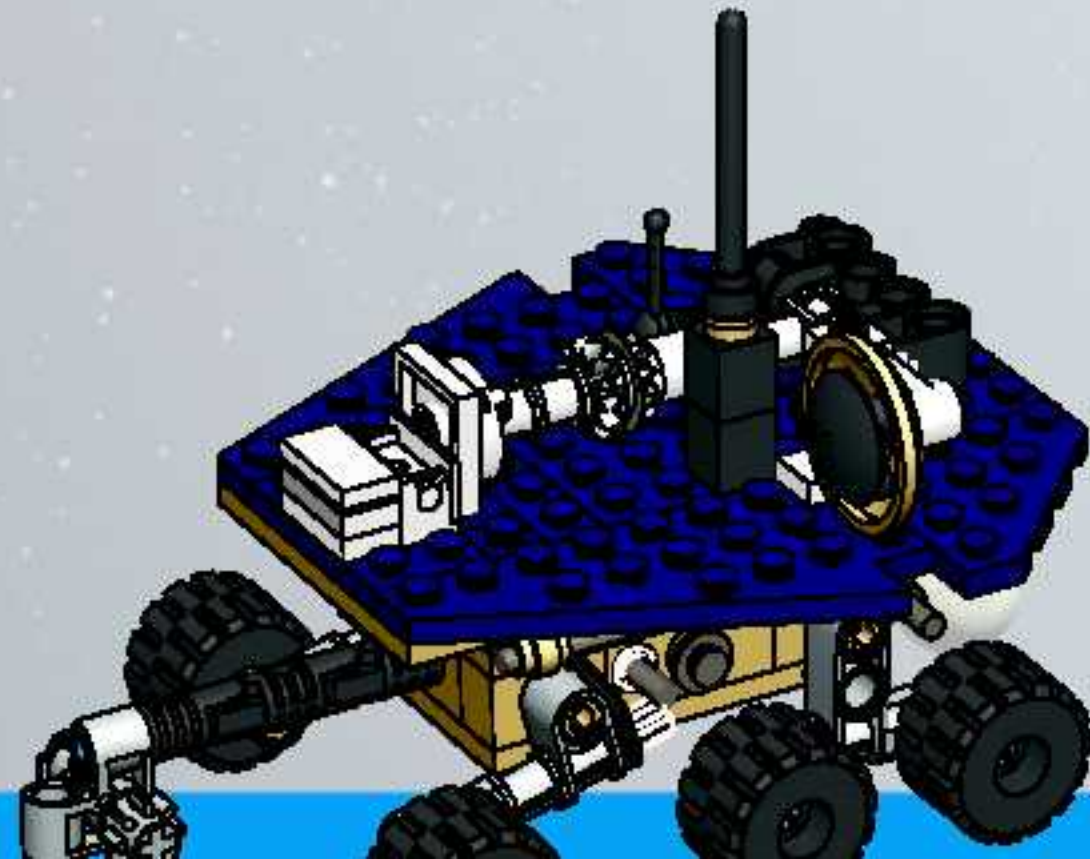

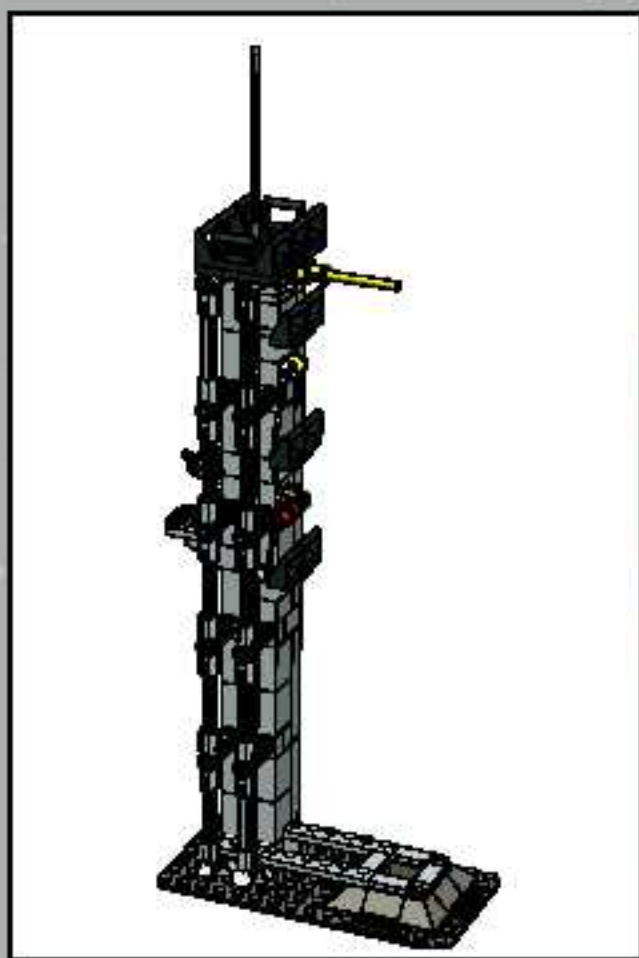

1

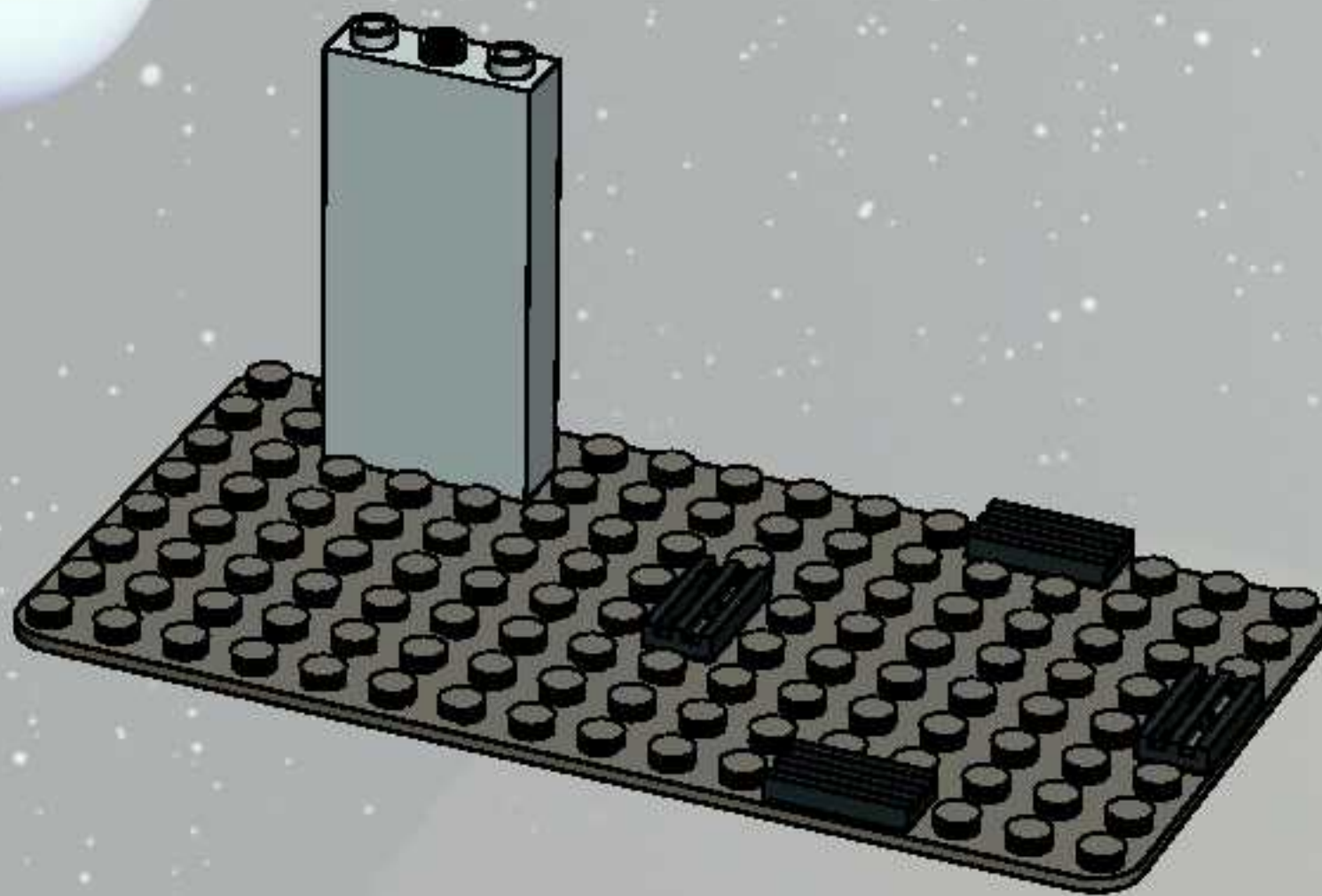

2

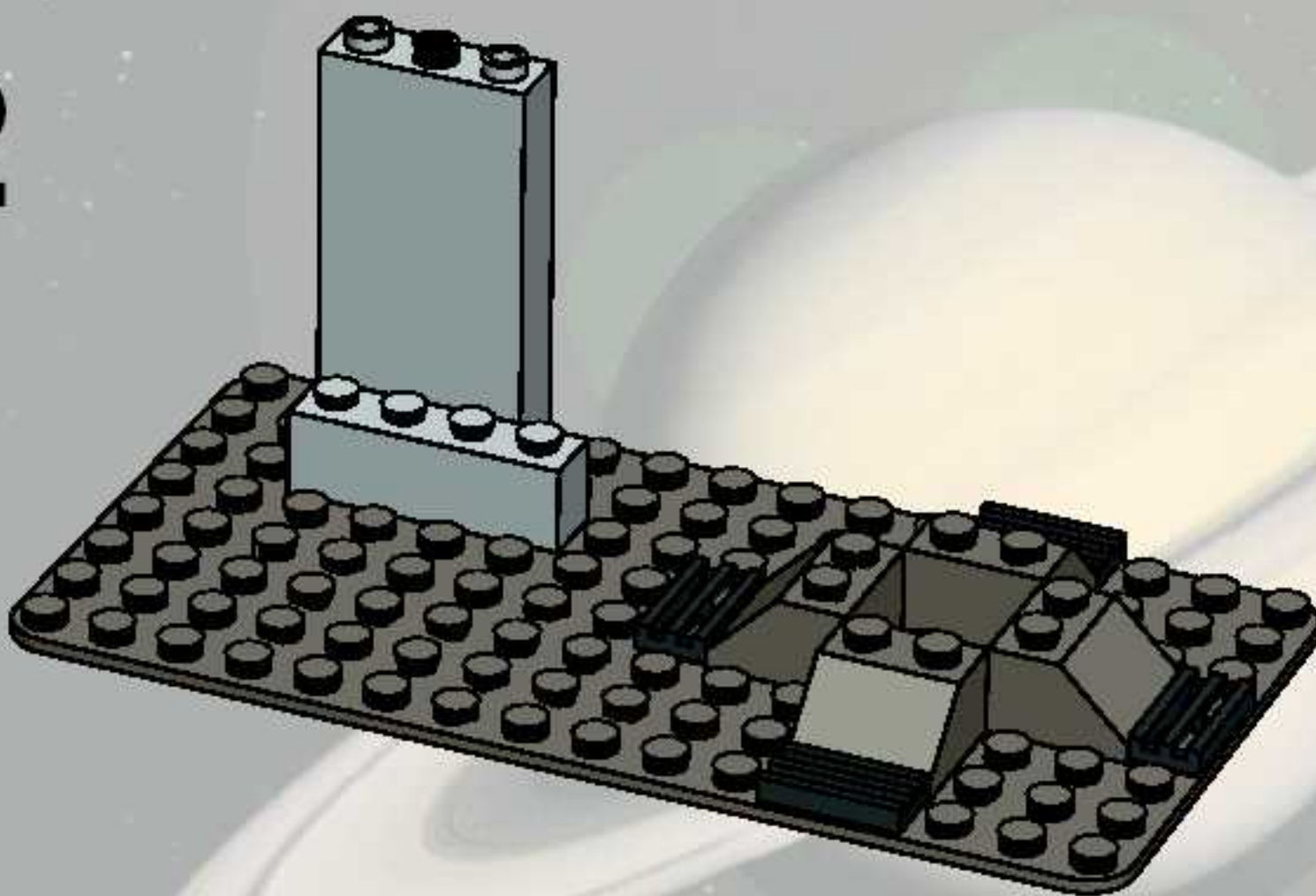

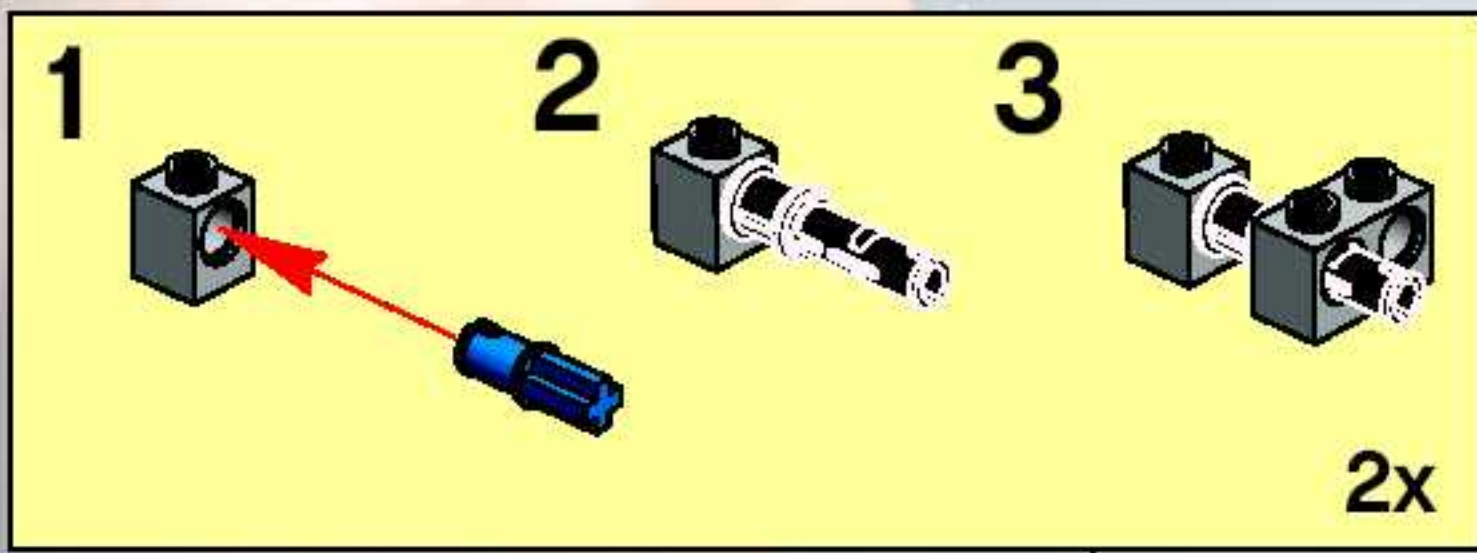

3

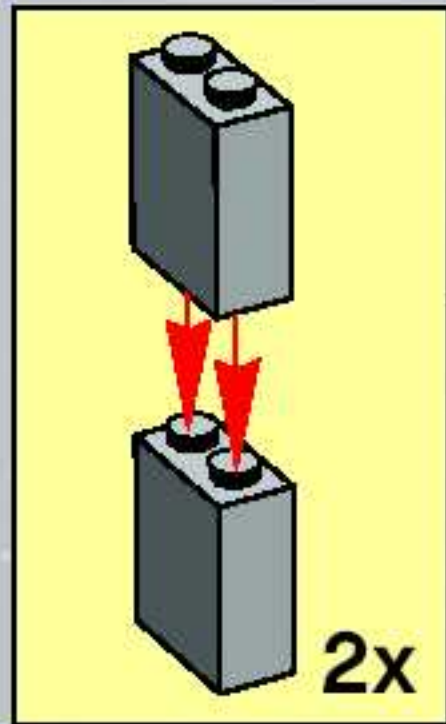
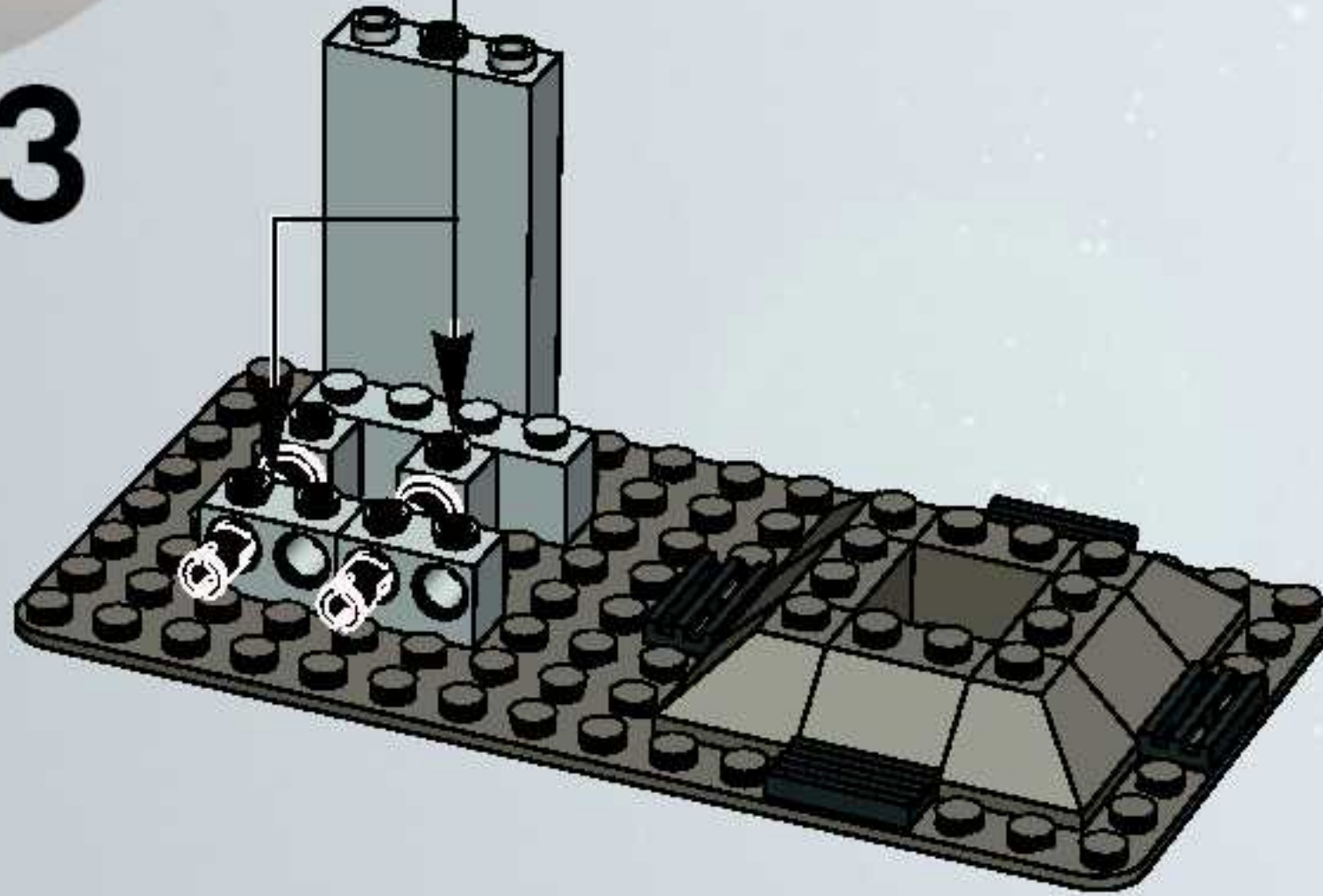

4

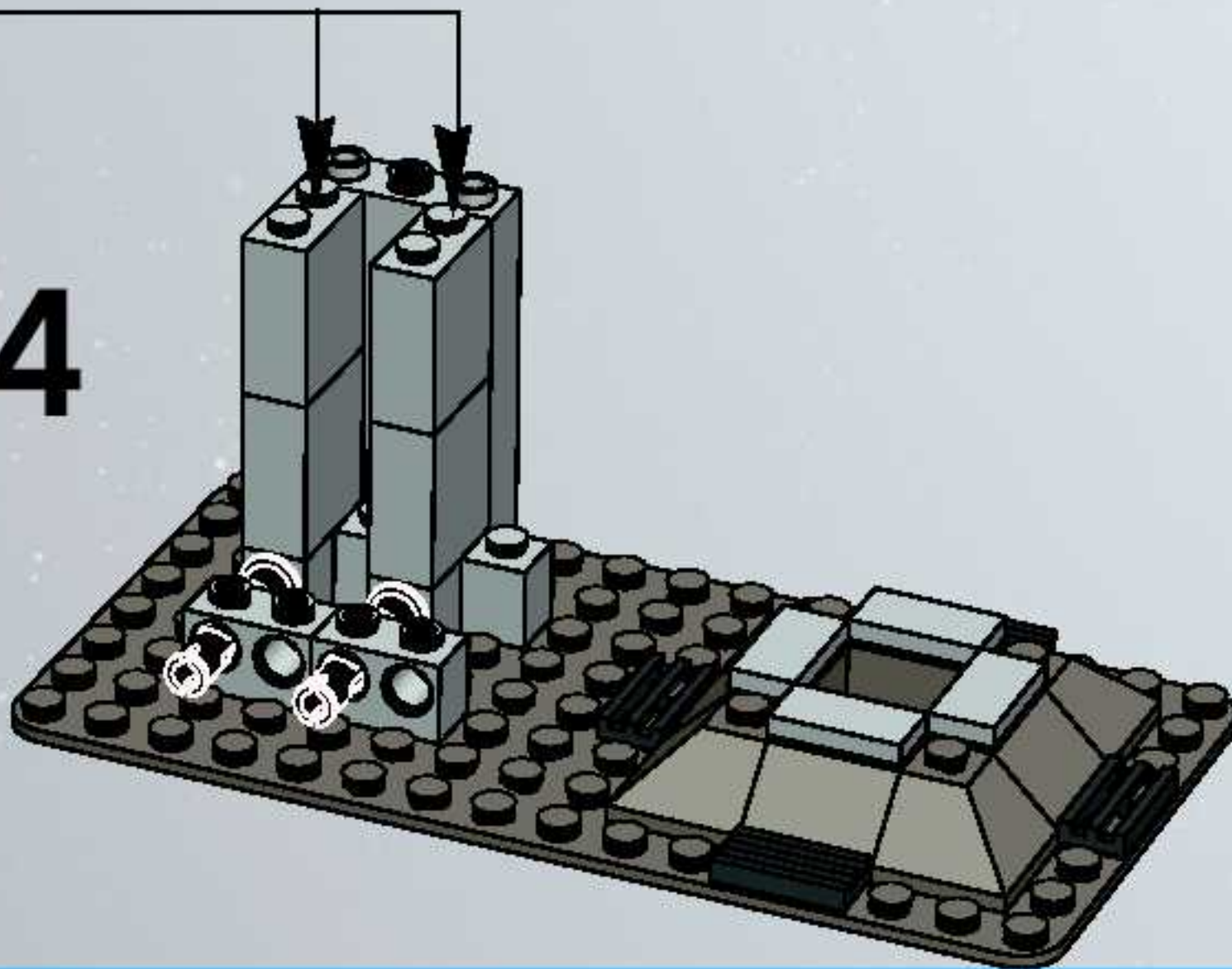

5

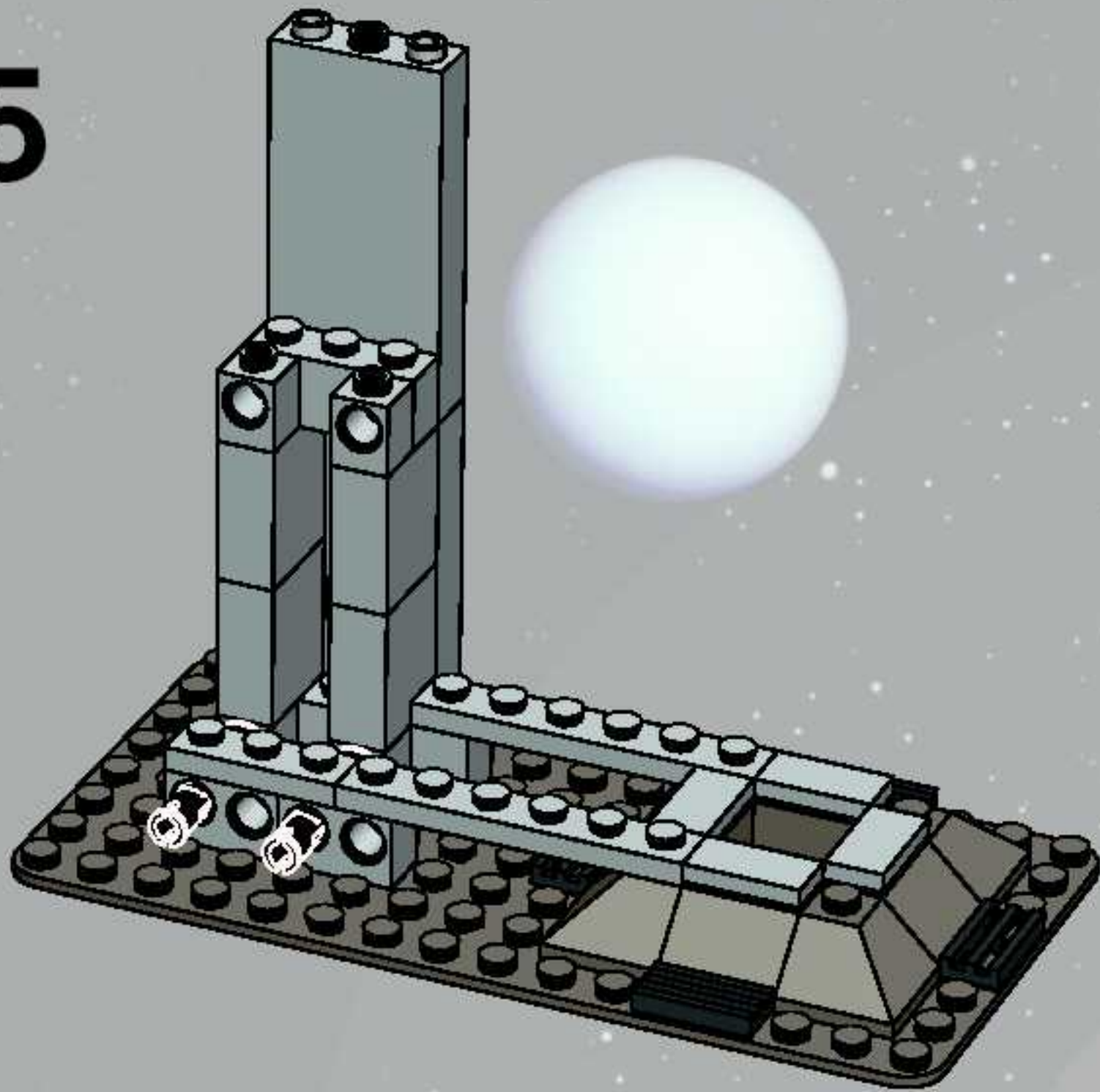

6

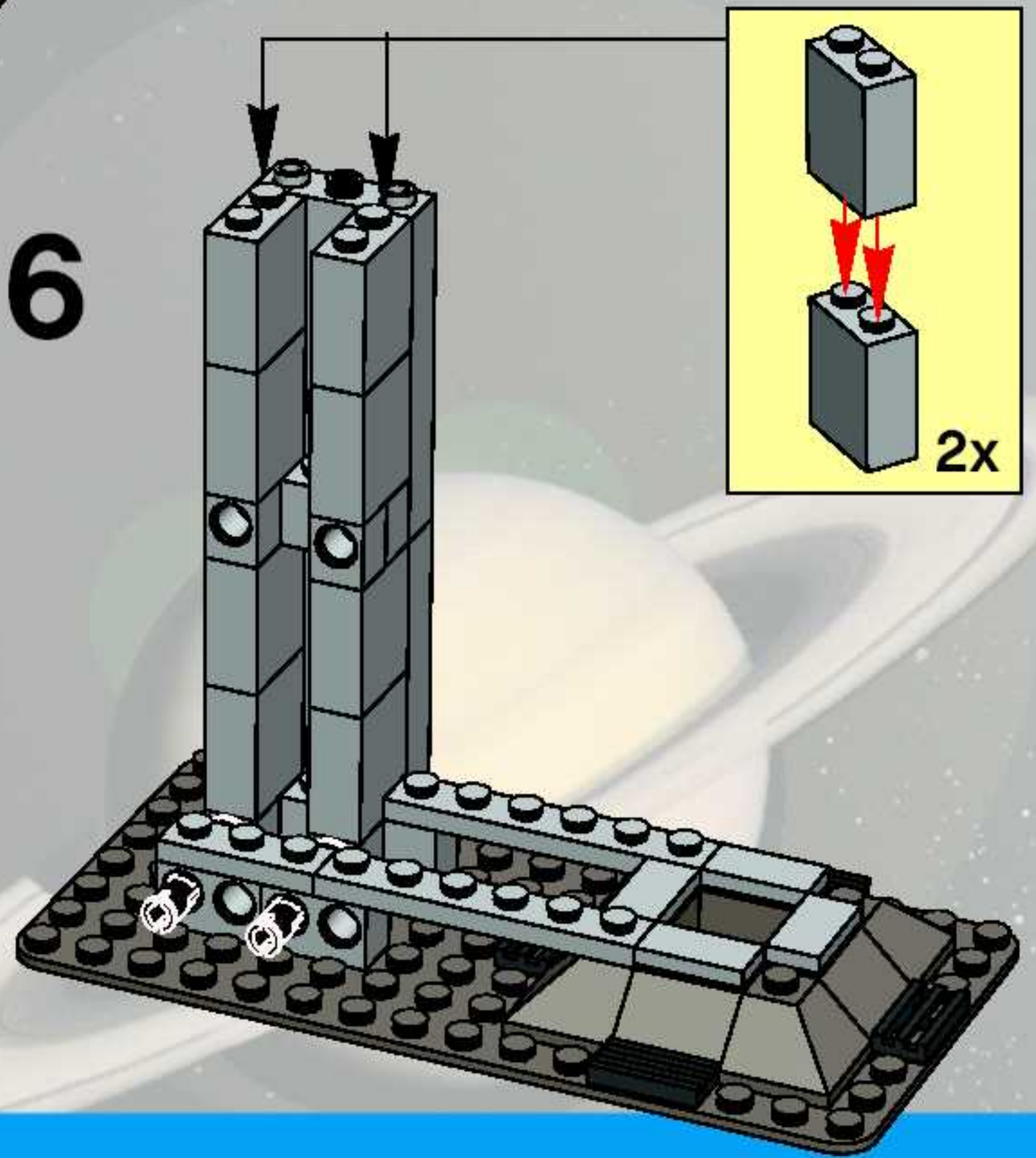



7

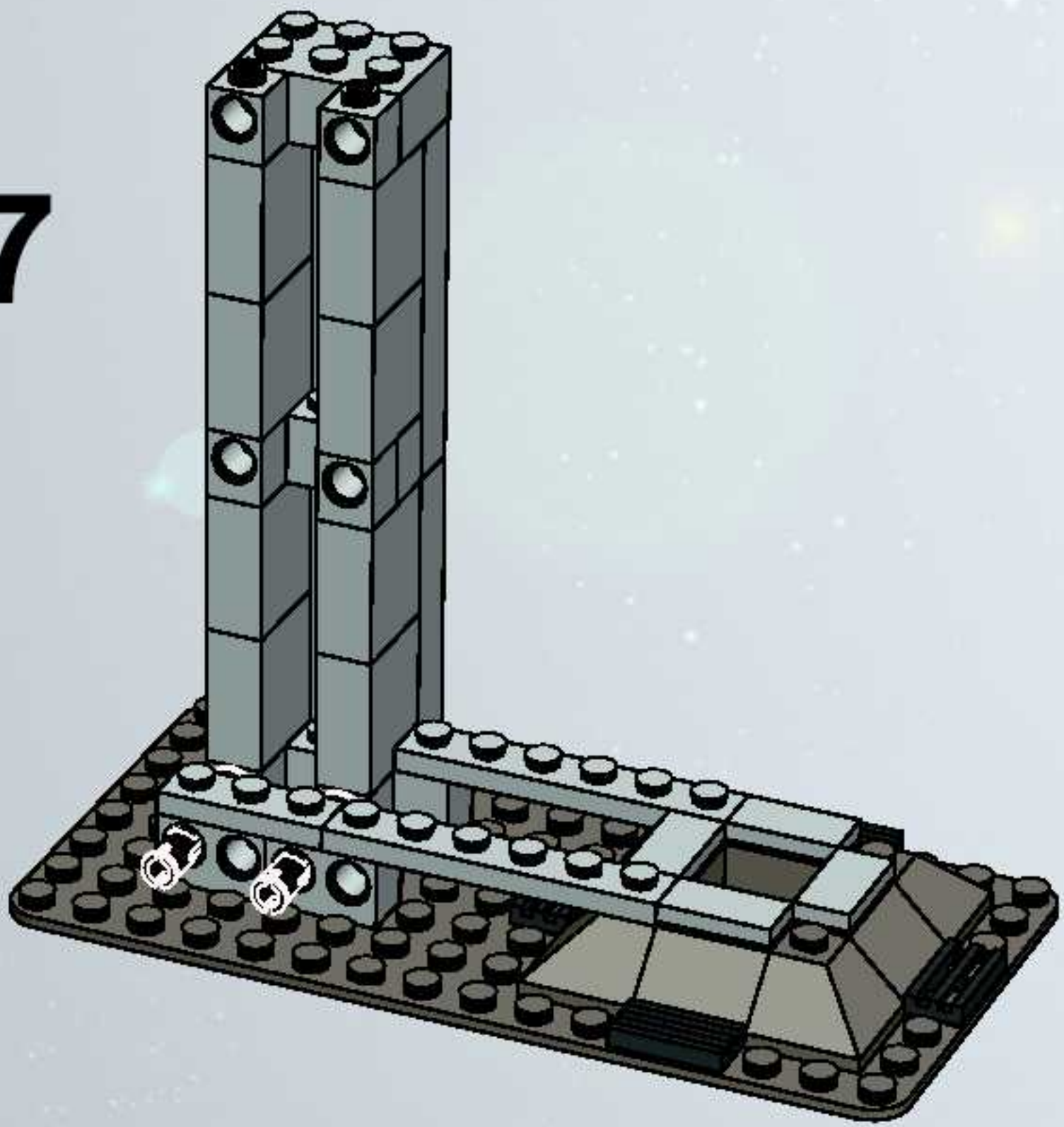

8

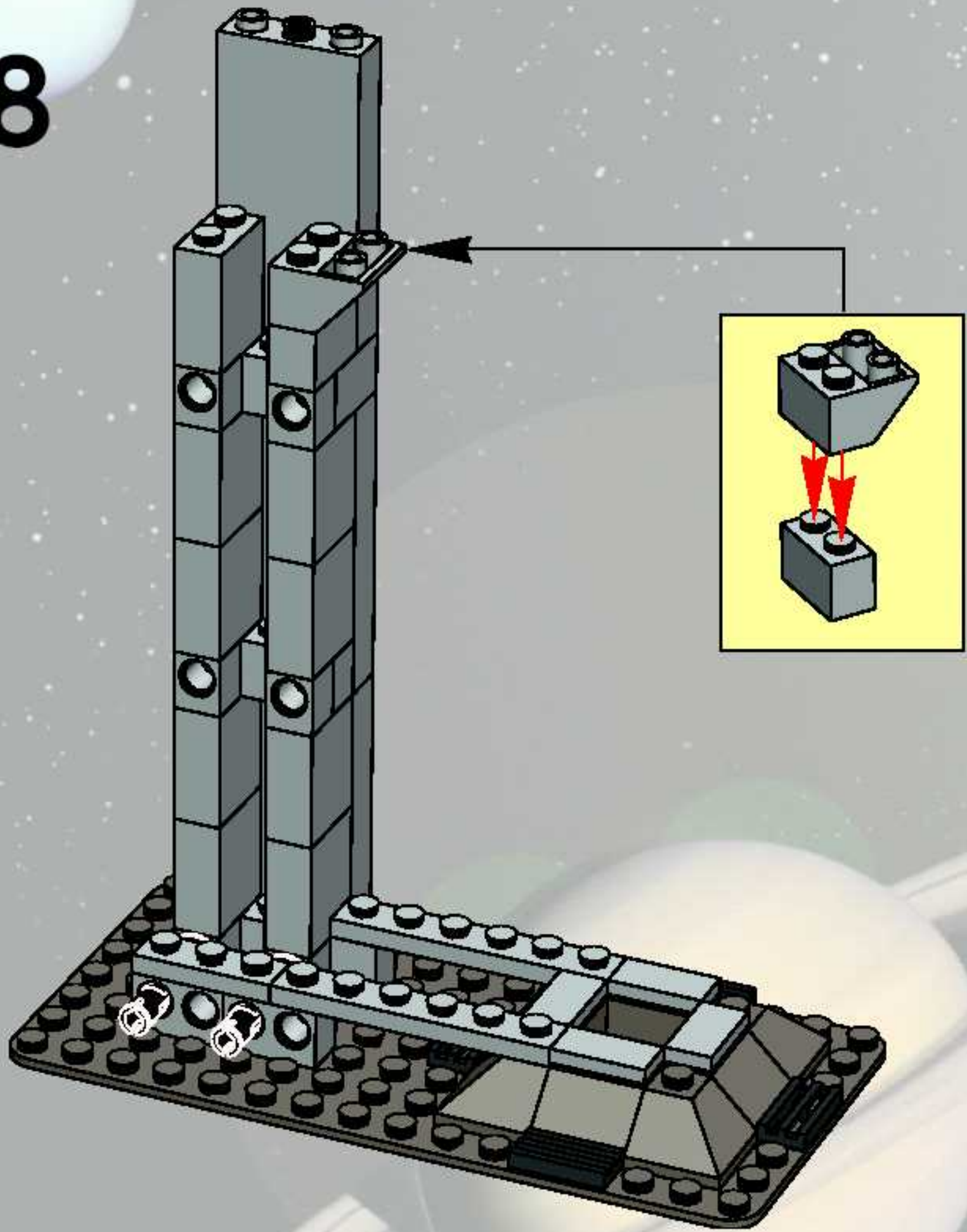

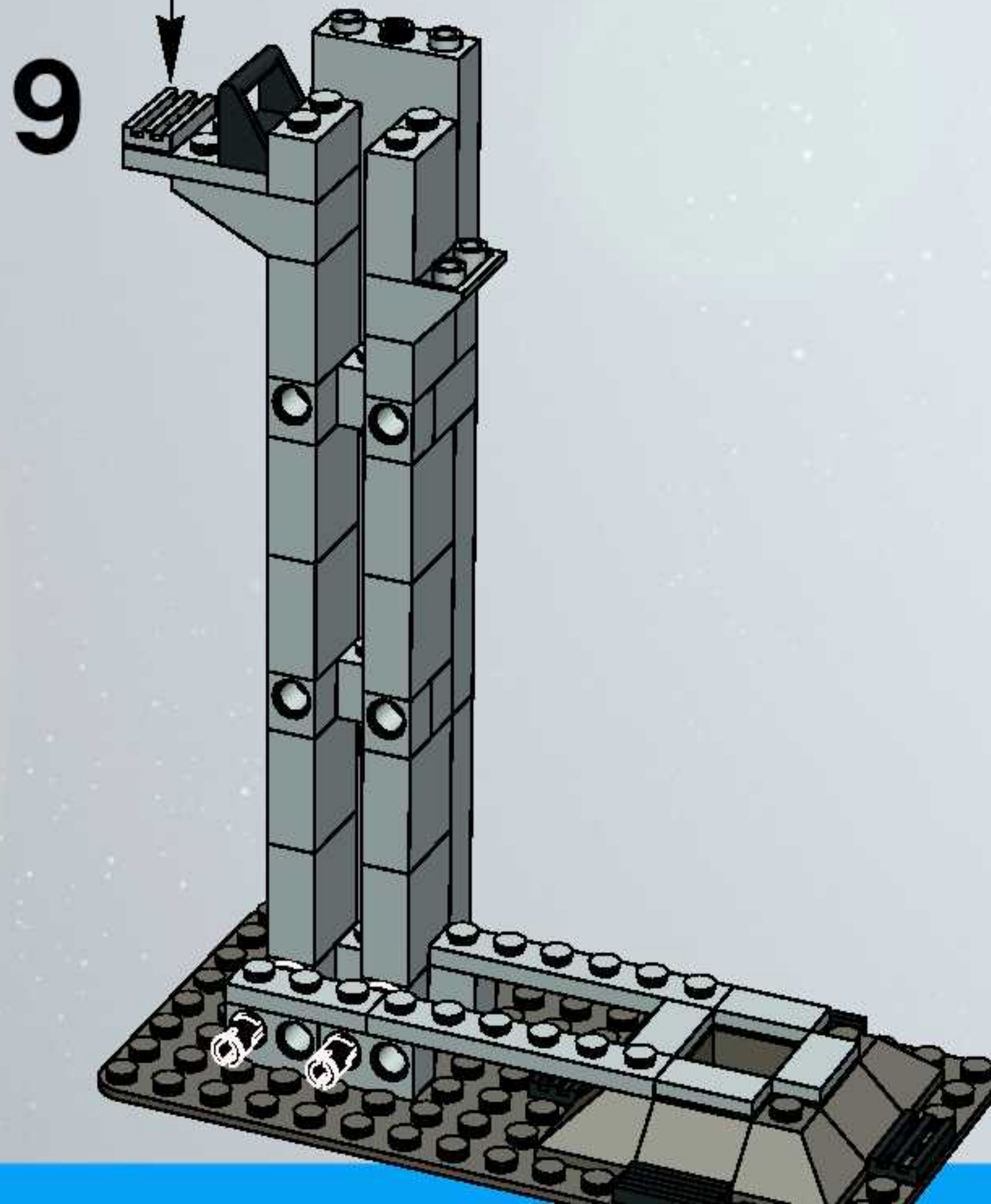
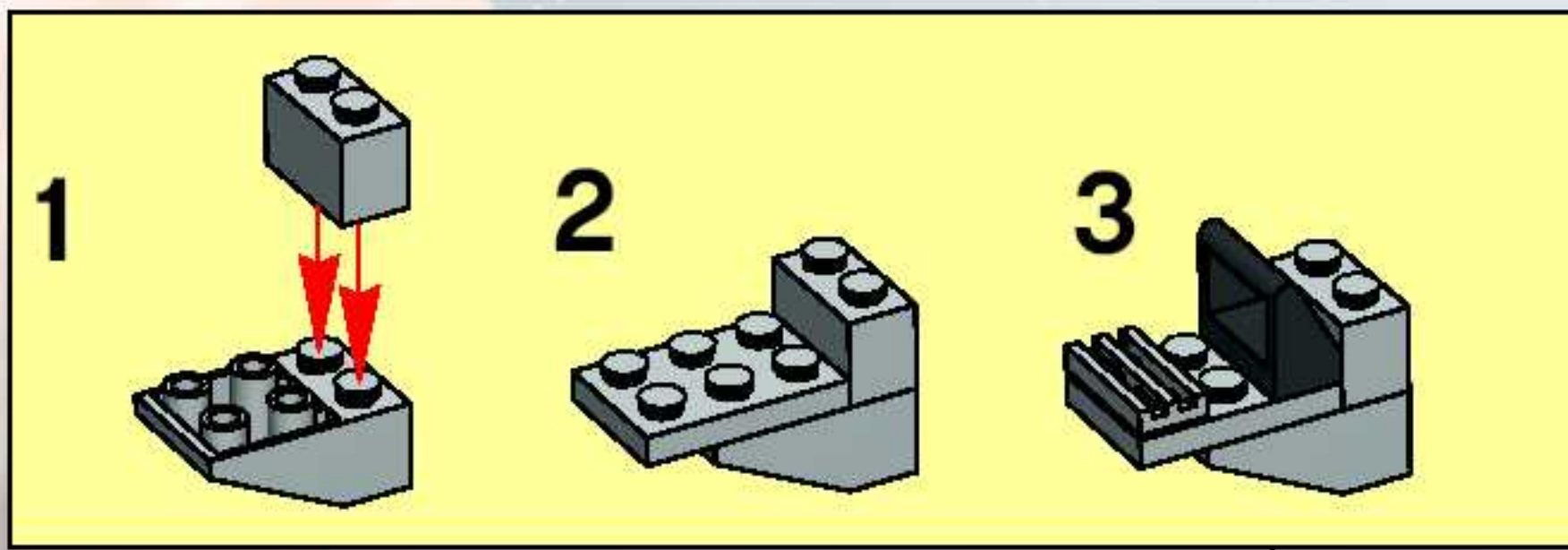

10

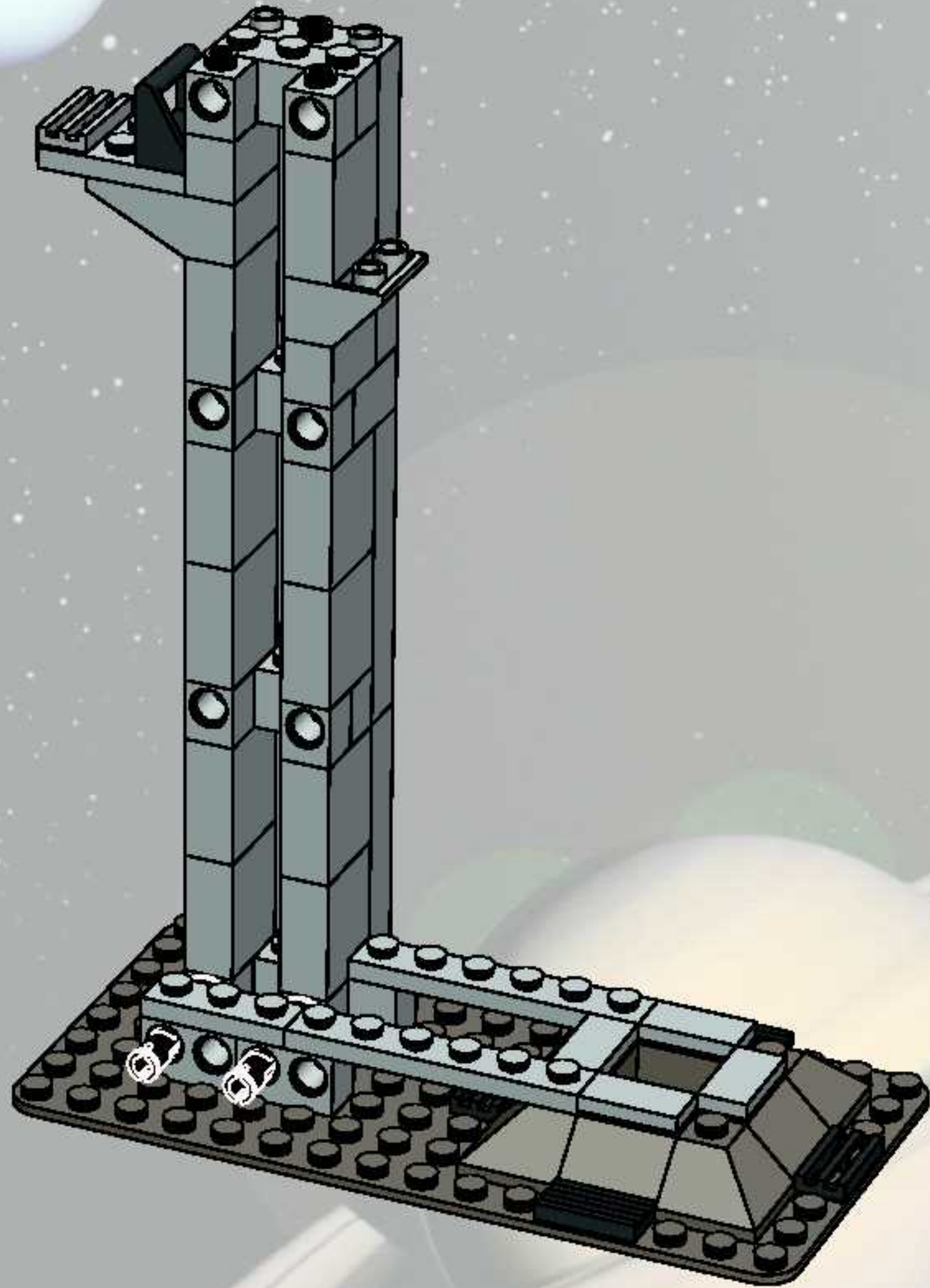

11

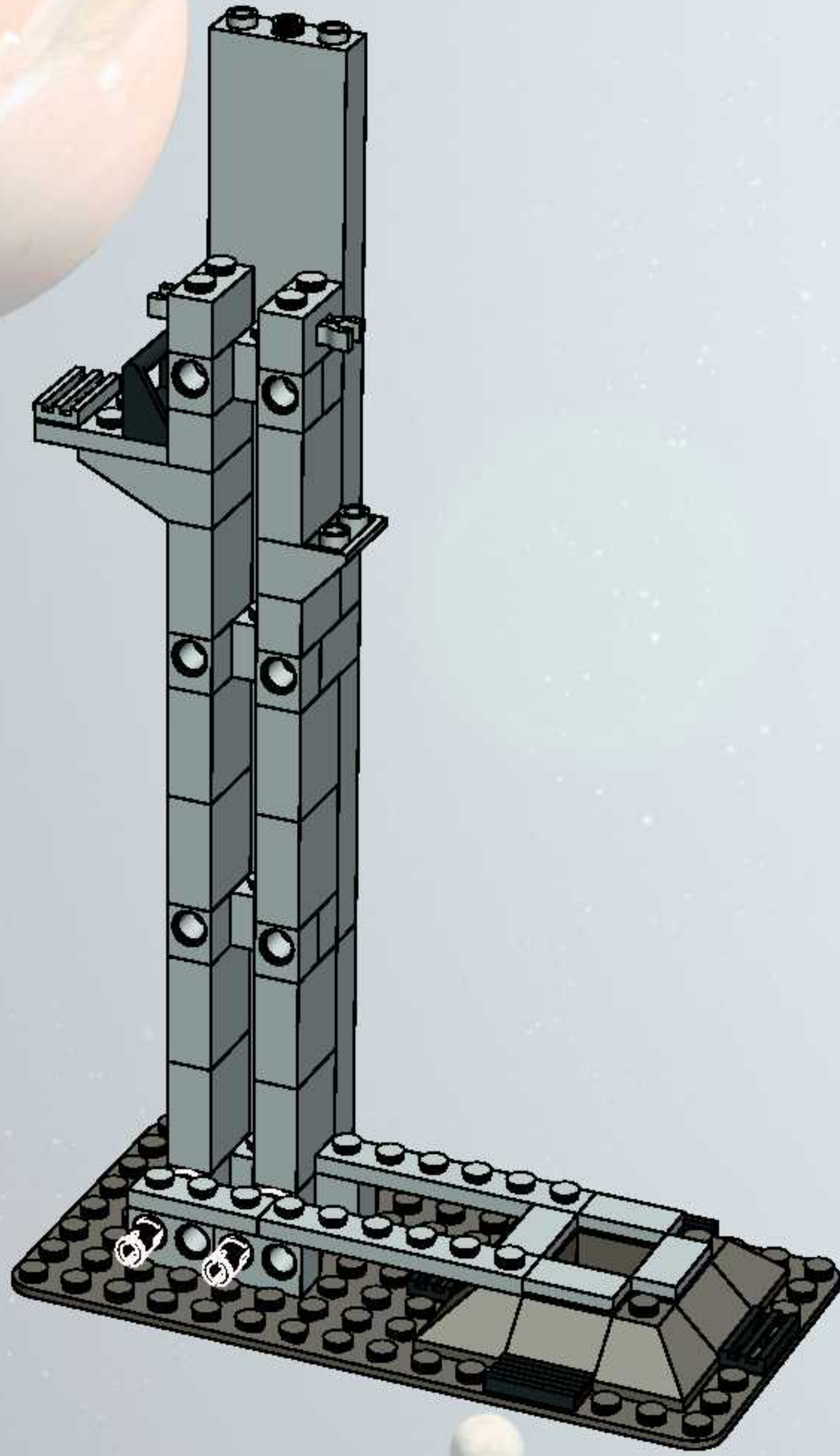

12

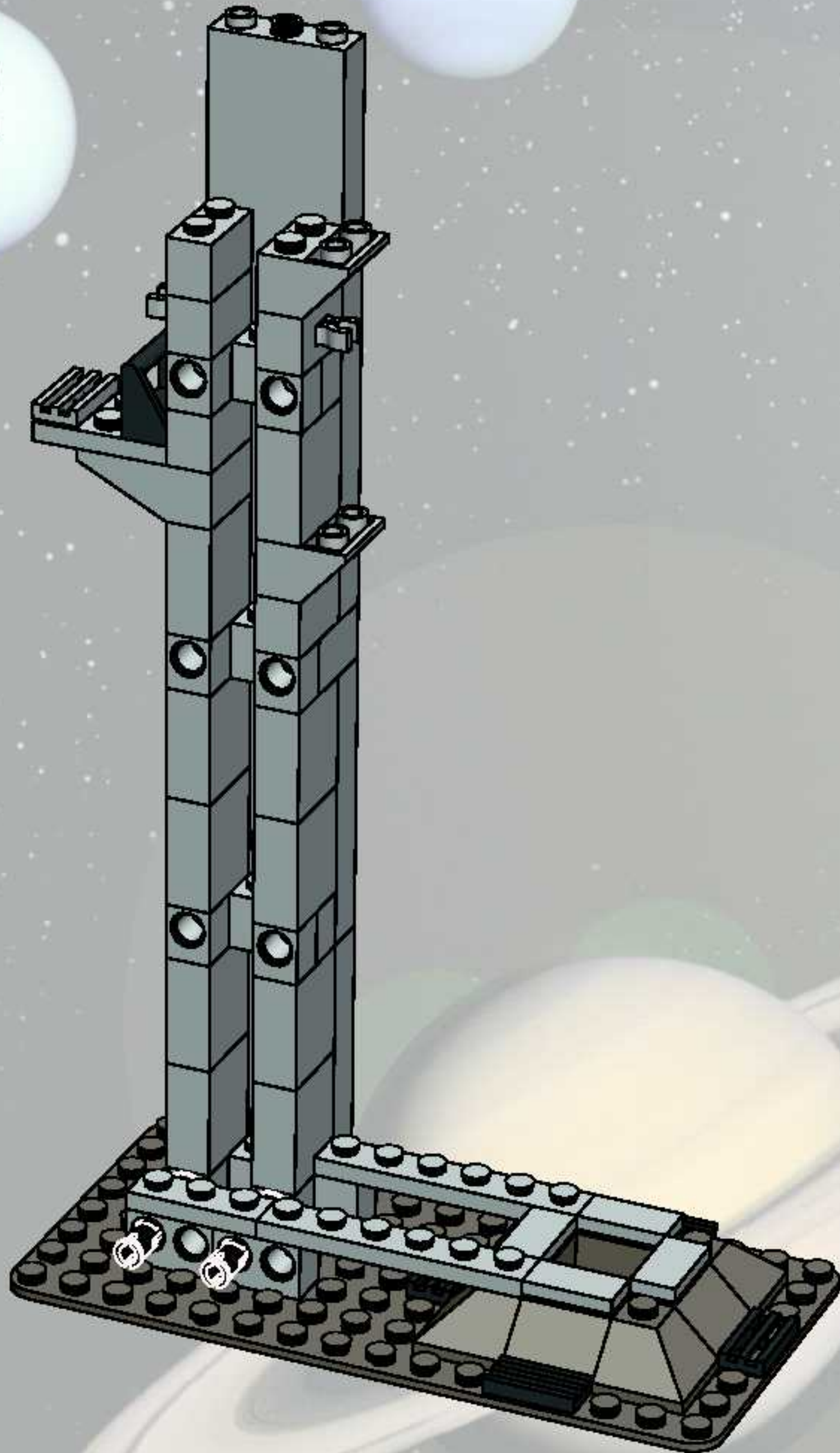

13

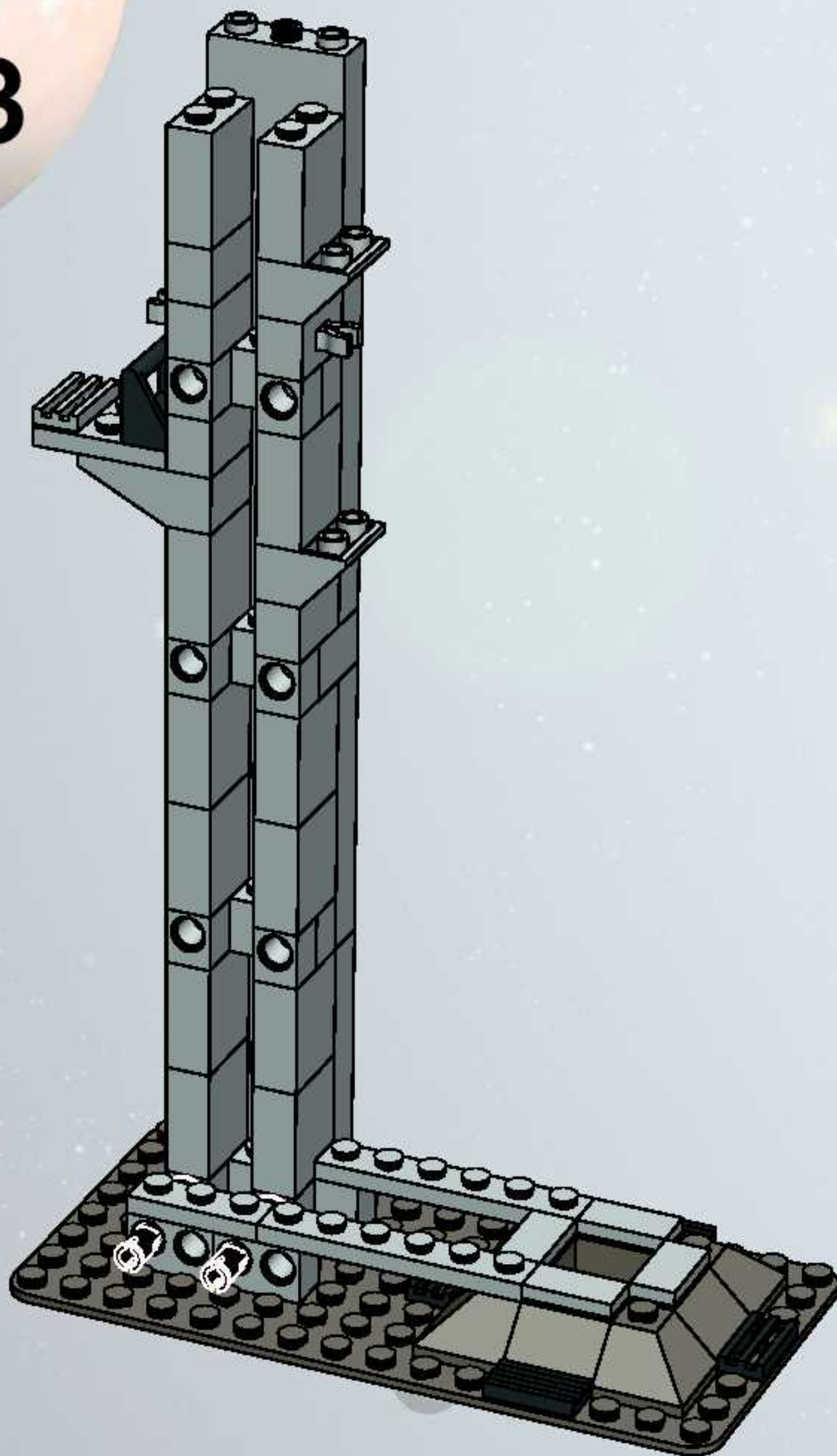

14

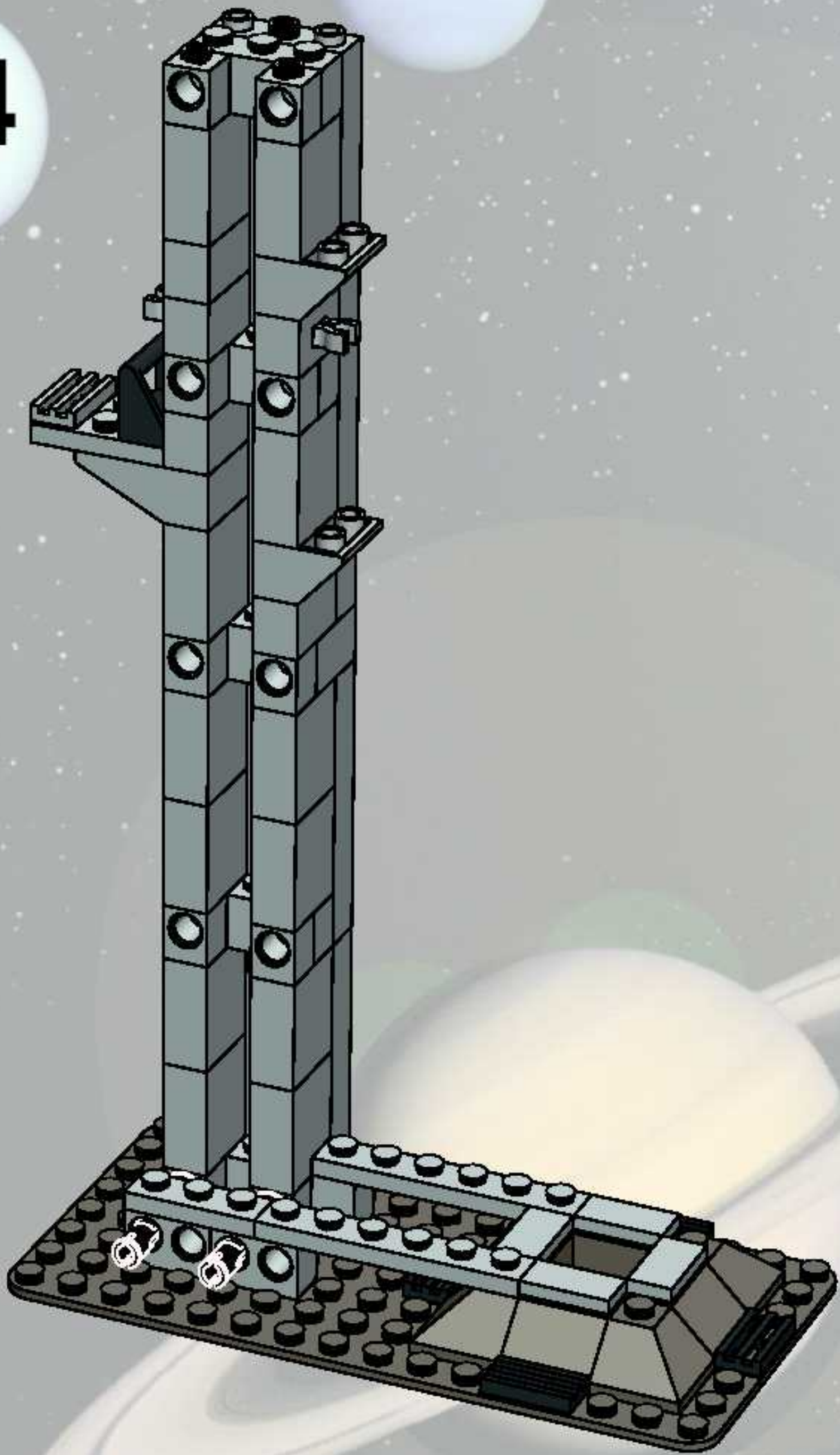

15

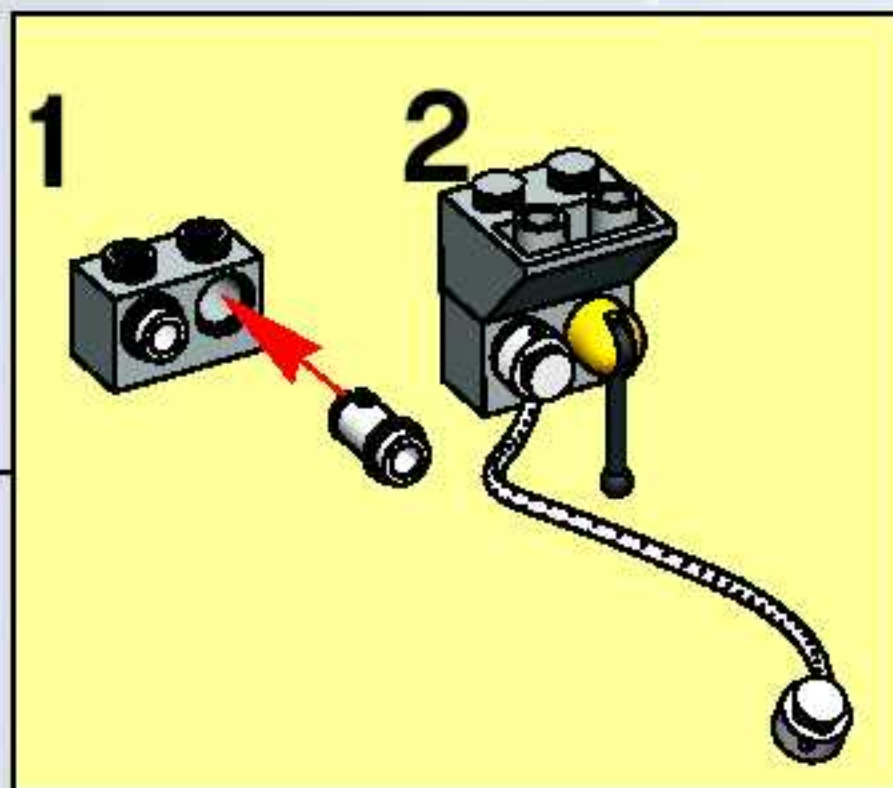
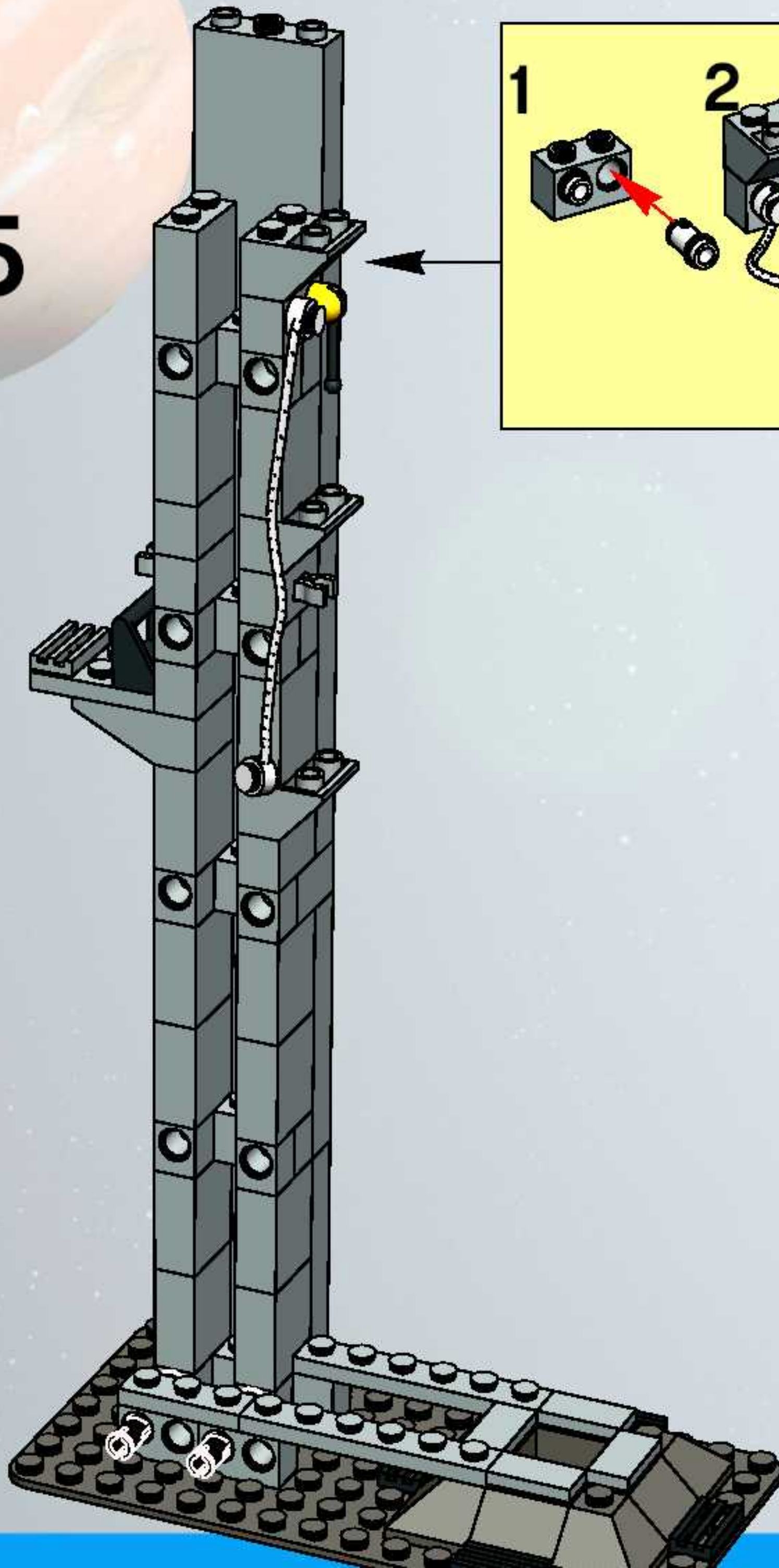

16

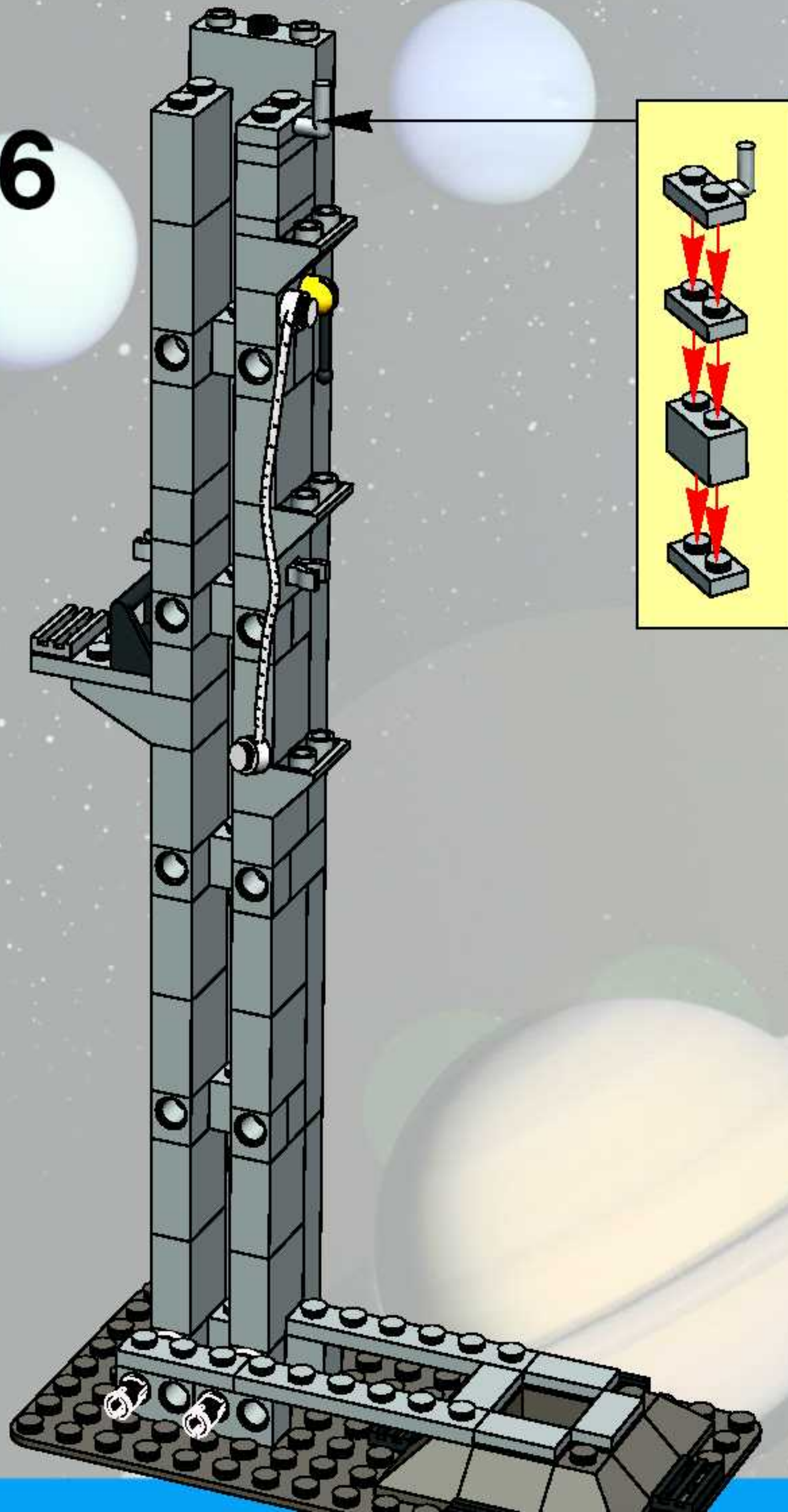

17

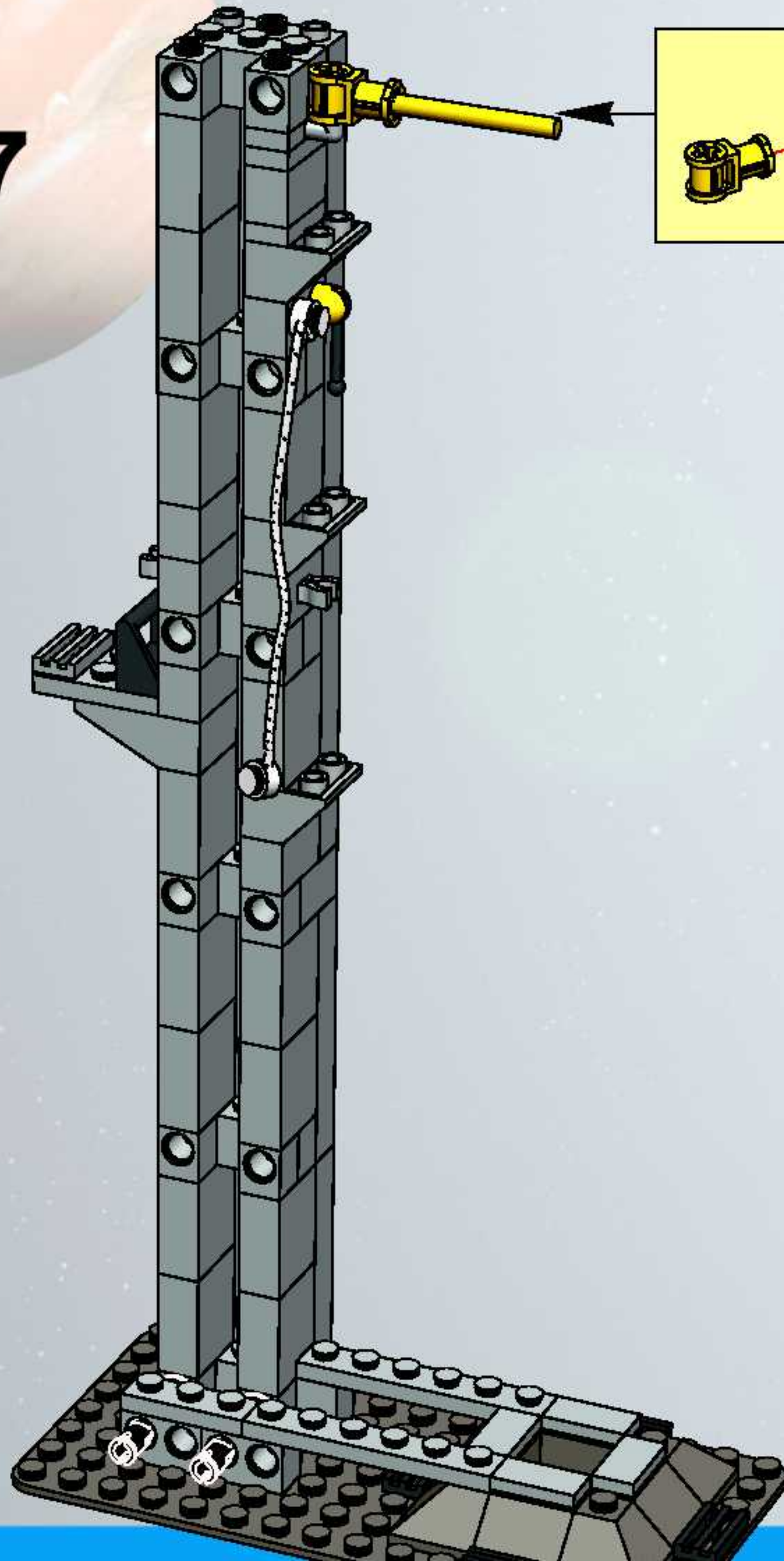

18

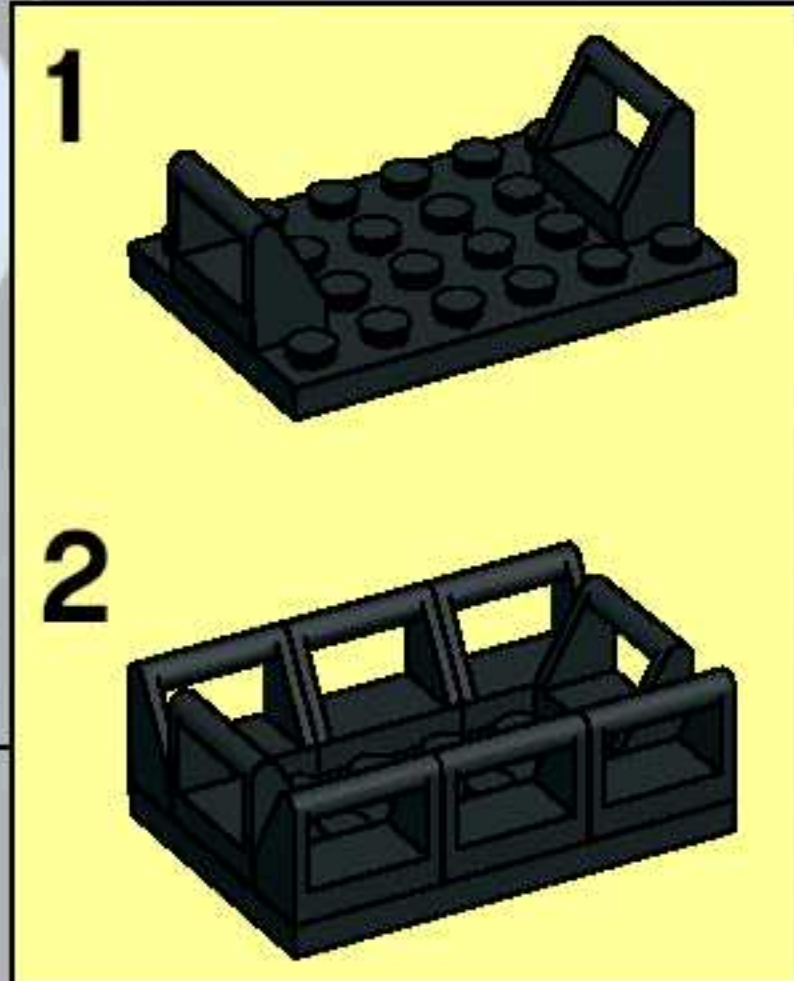
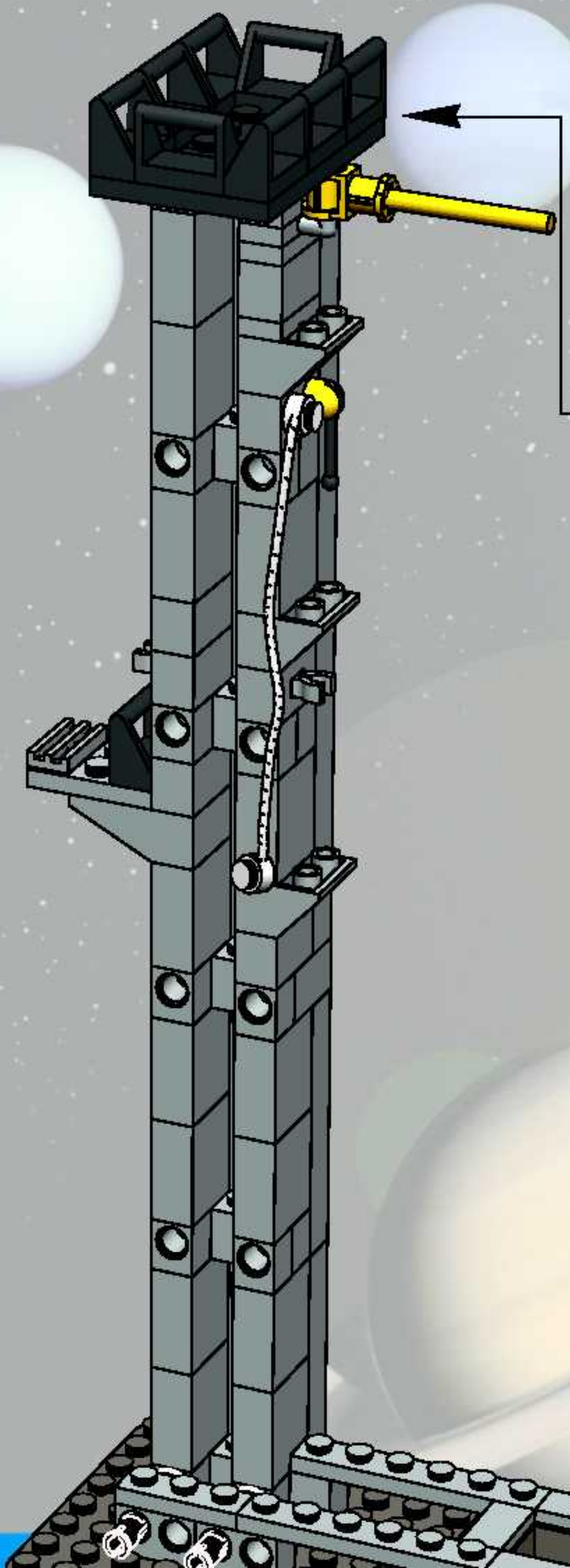

1

2

19

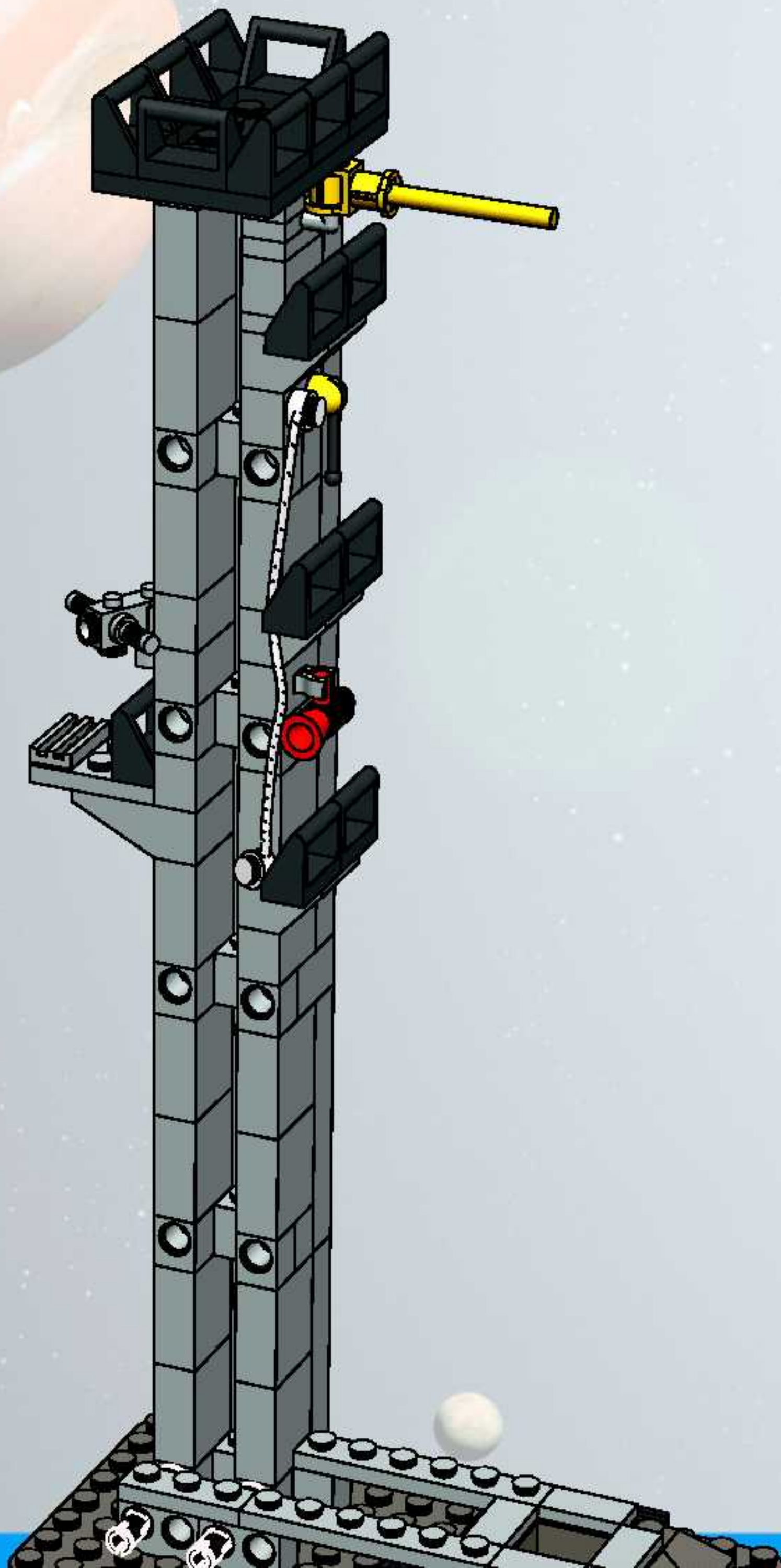

1

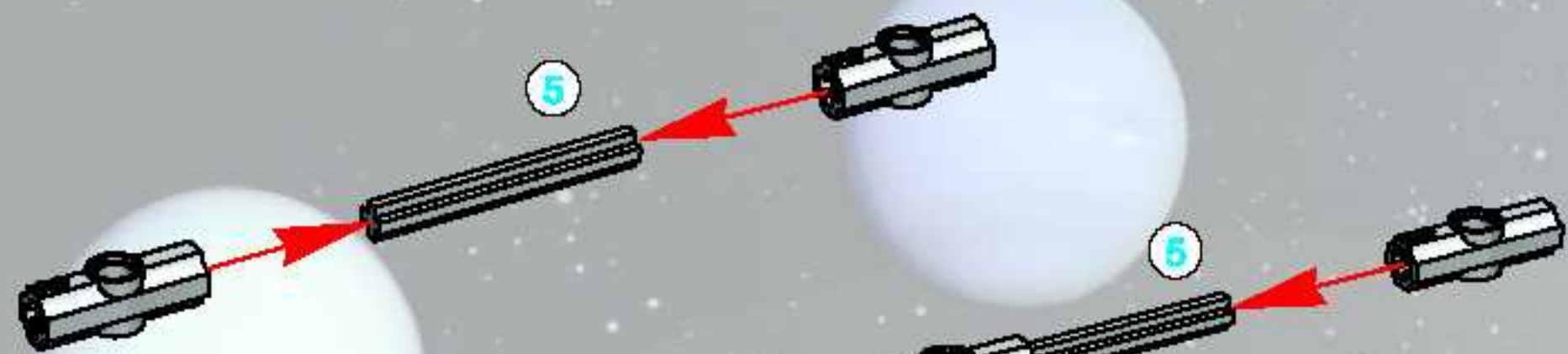

2

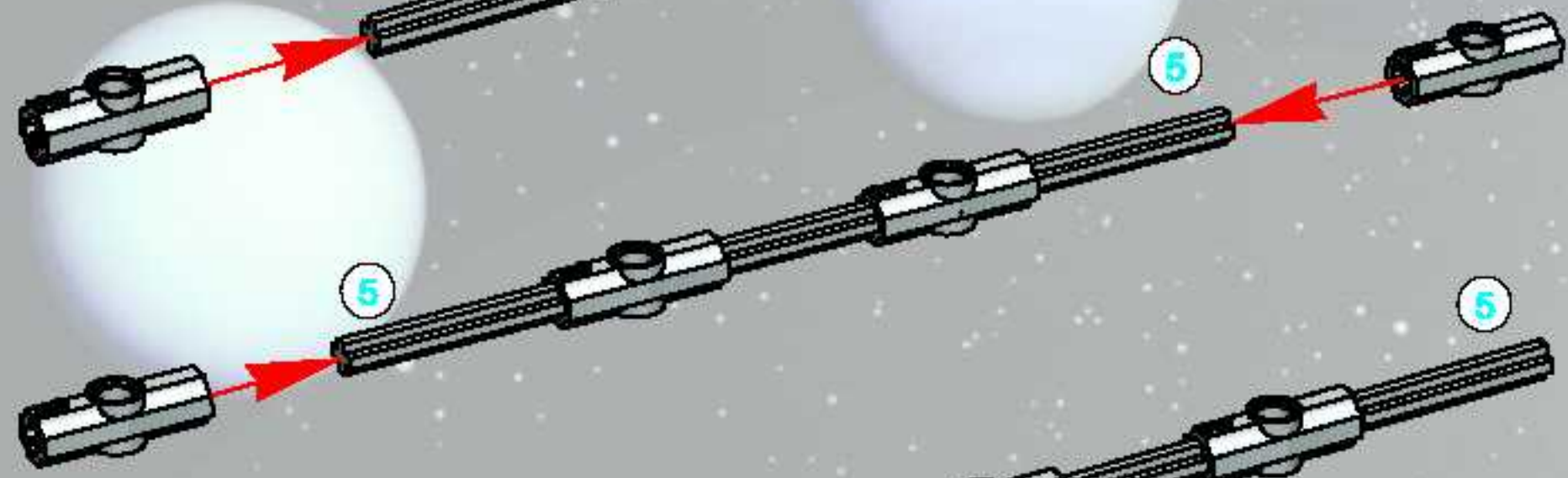

3

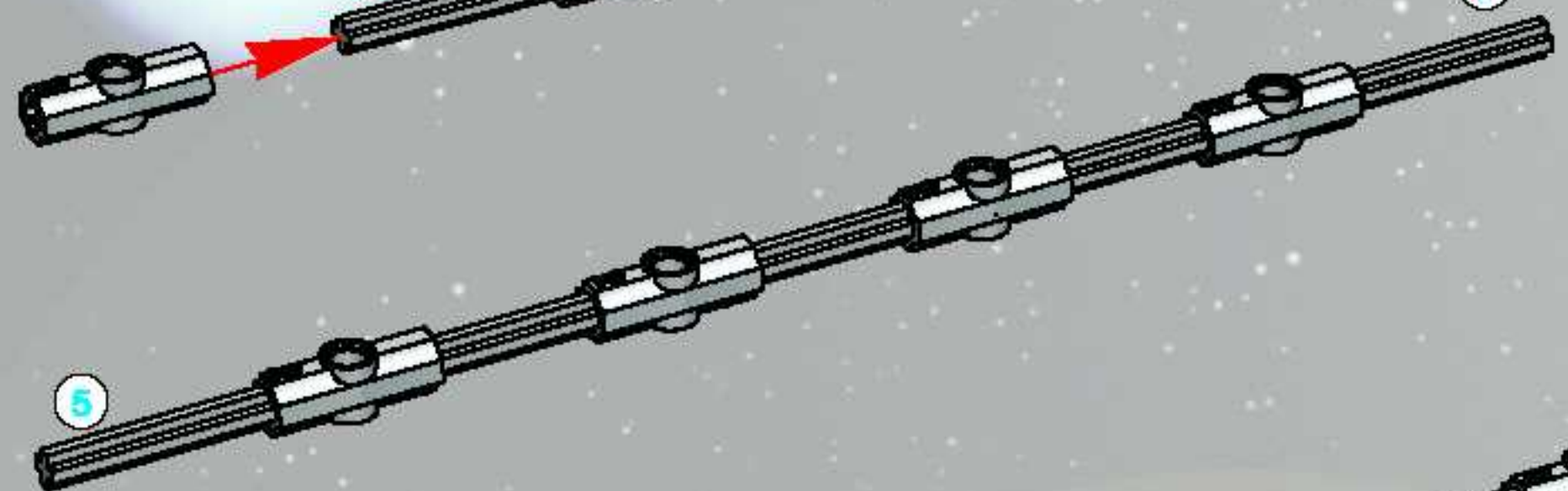

4

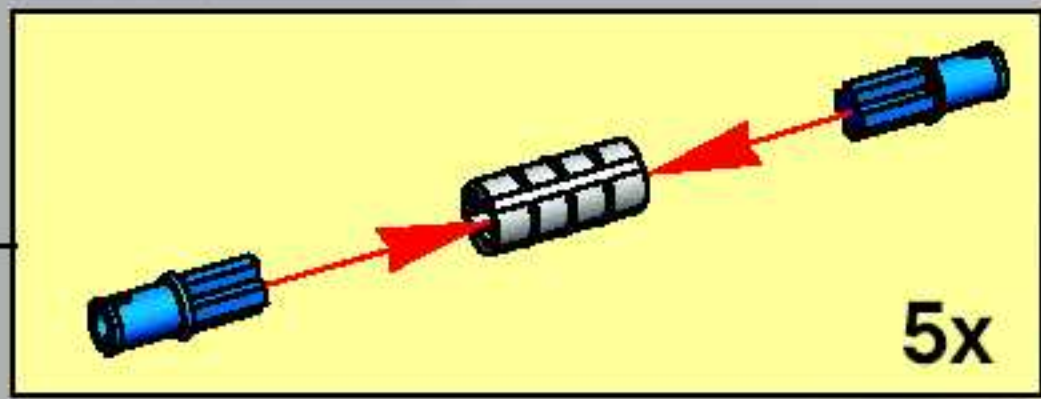
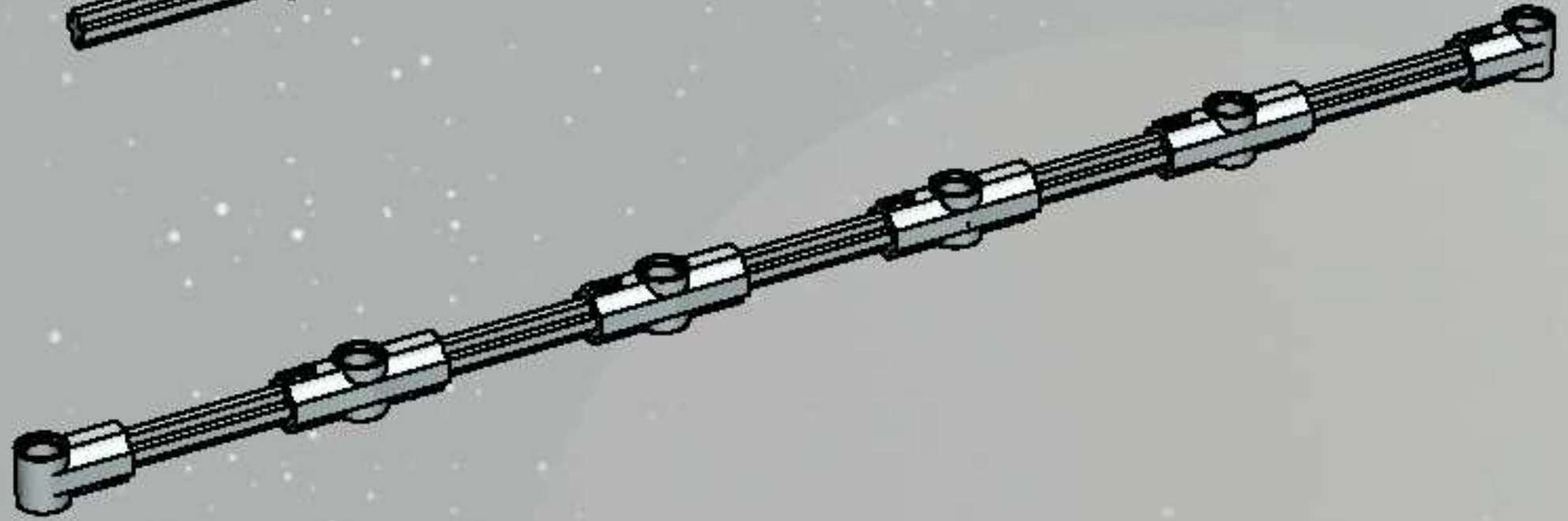

5

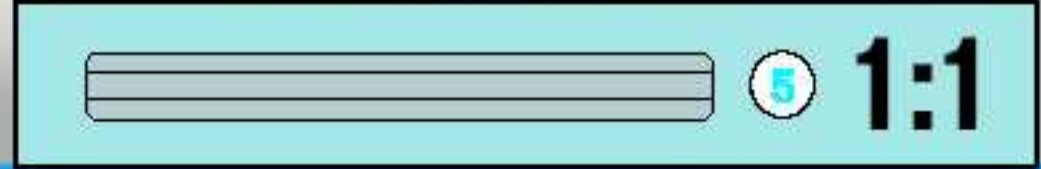
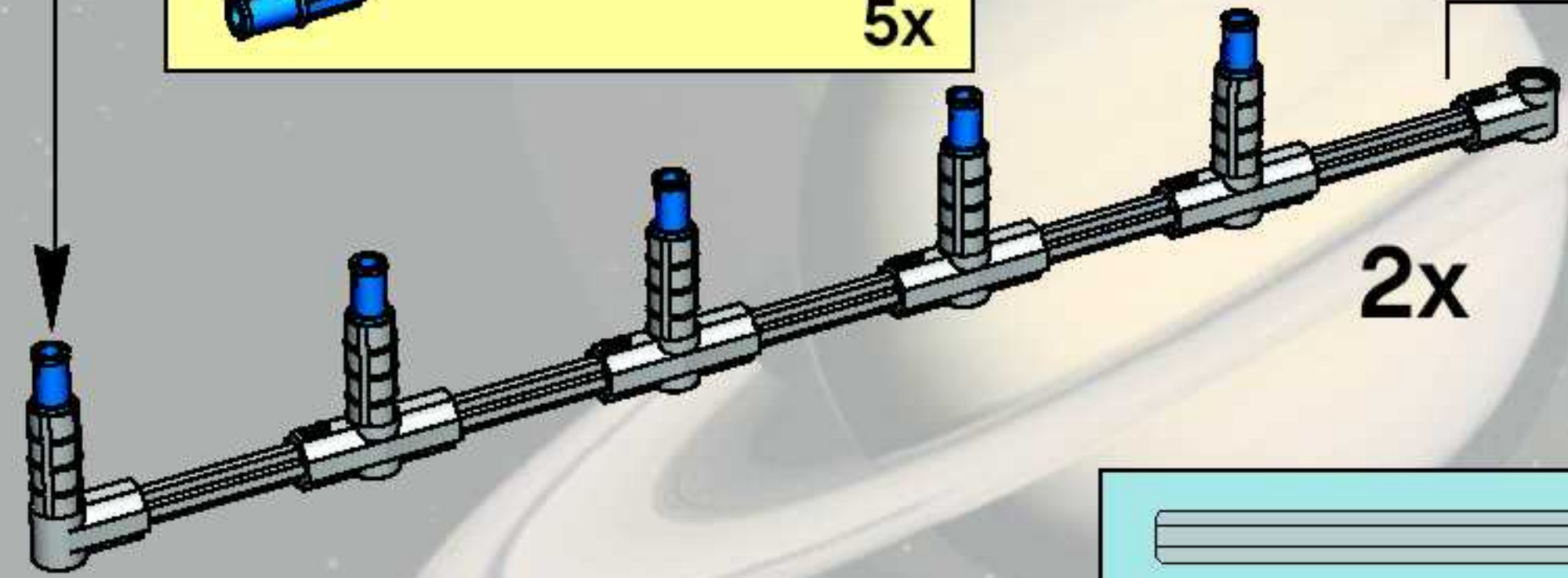

20

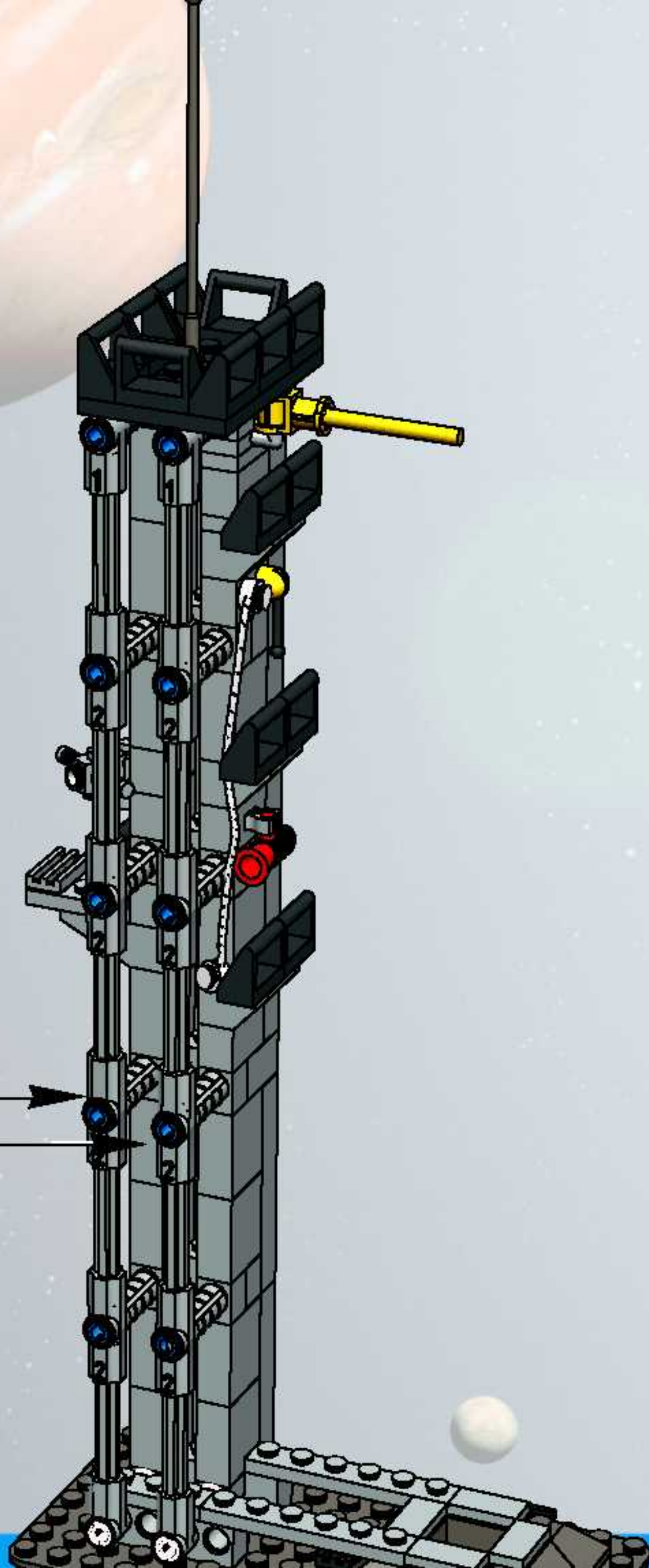

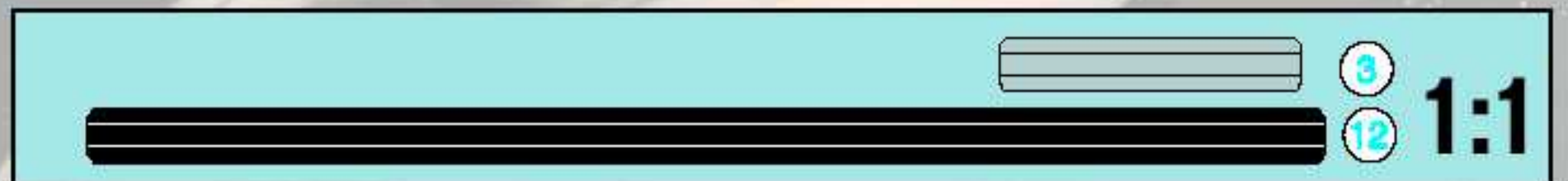
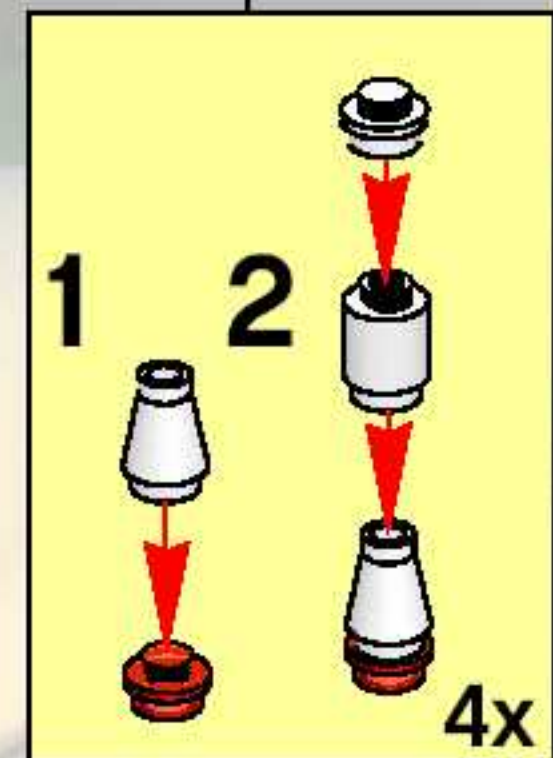
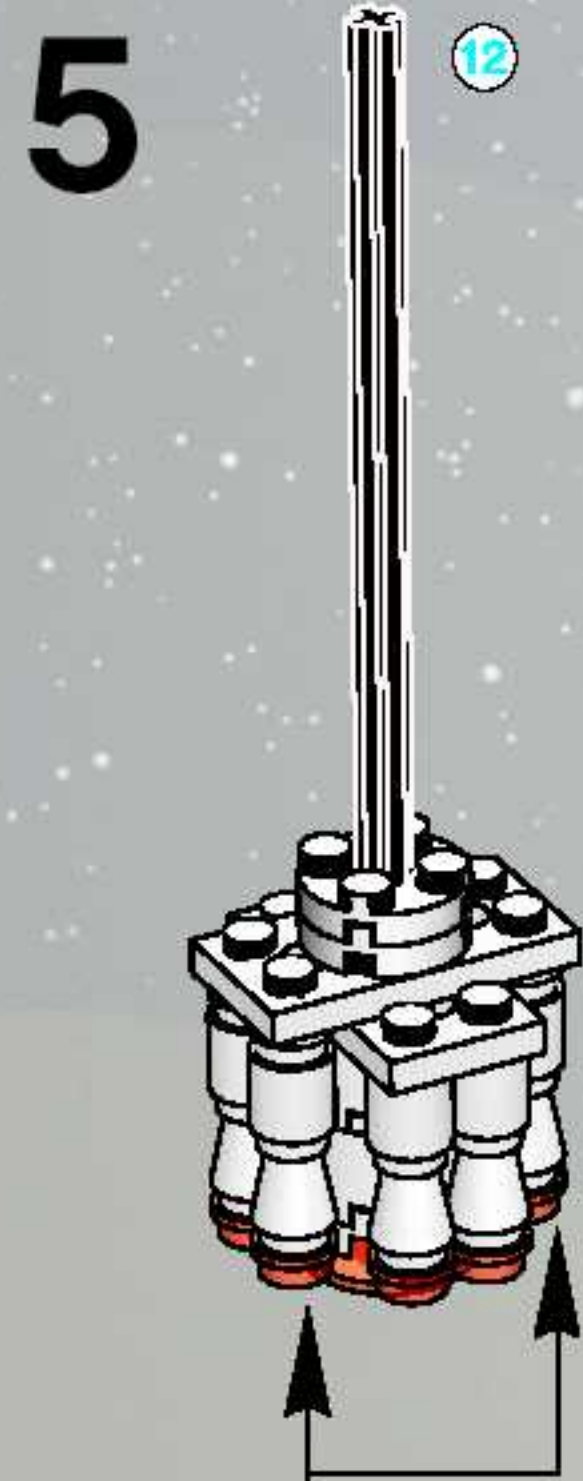
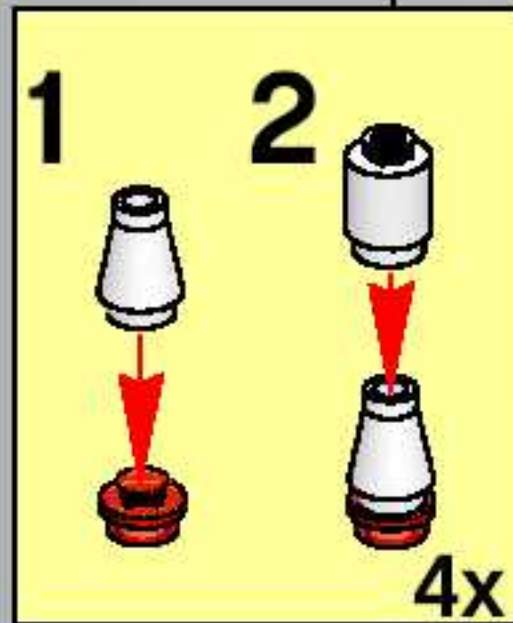
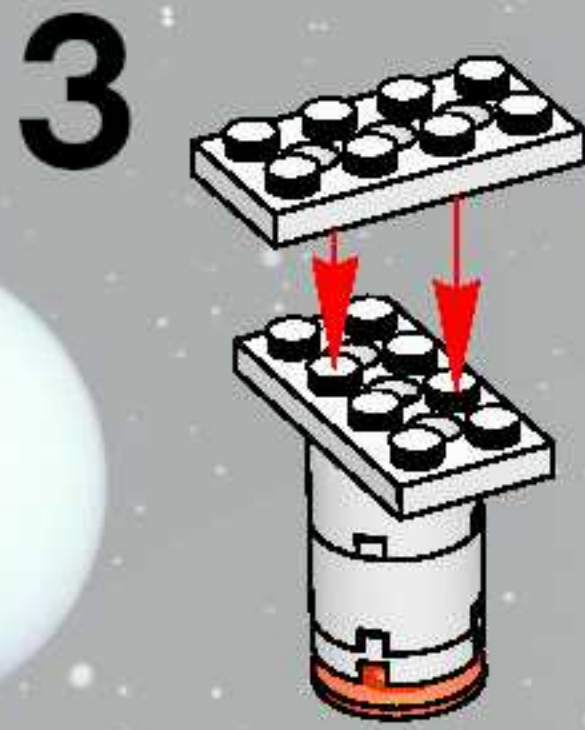
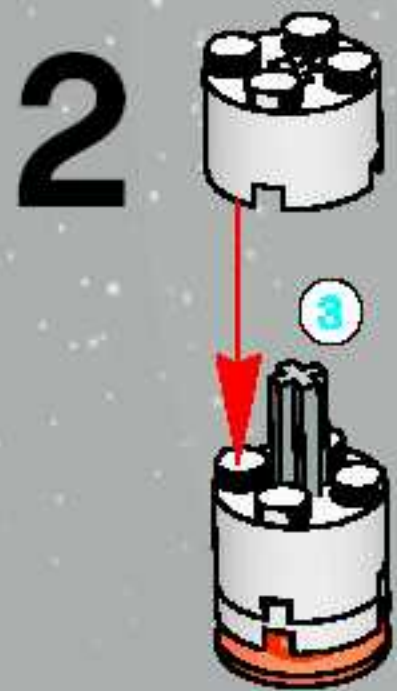
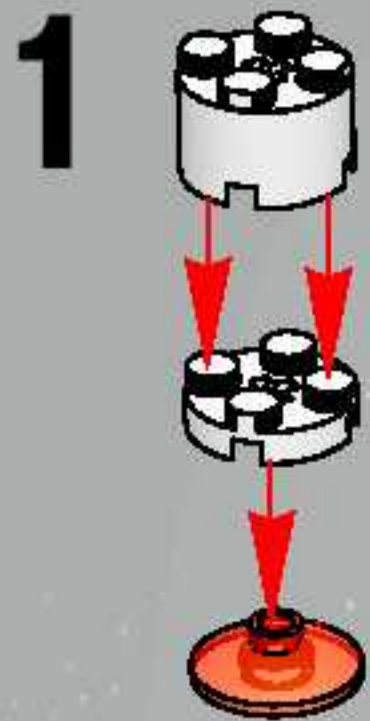
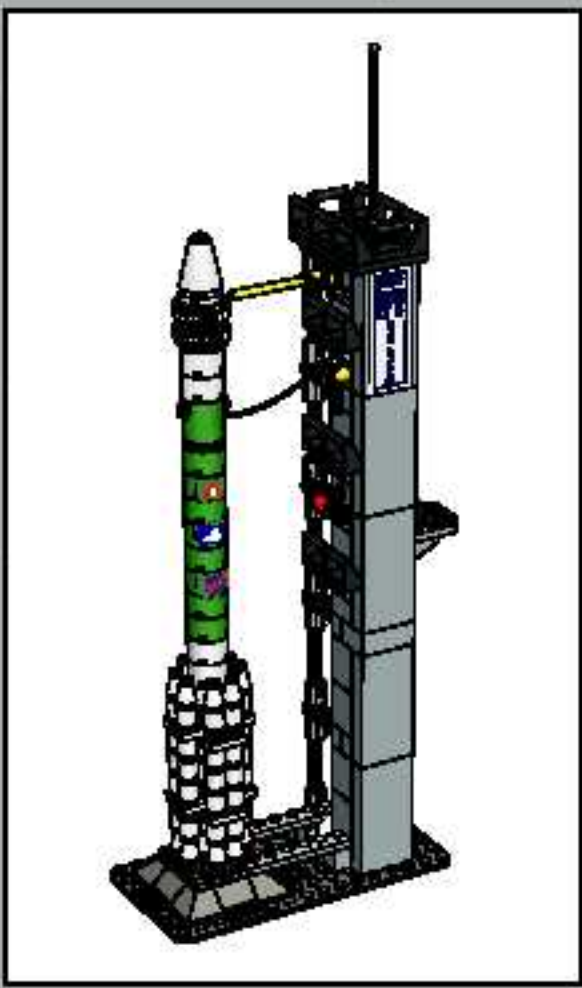

6

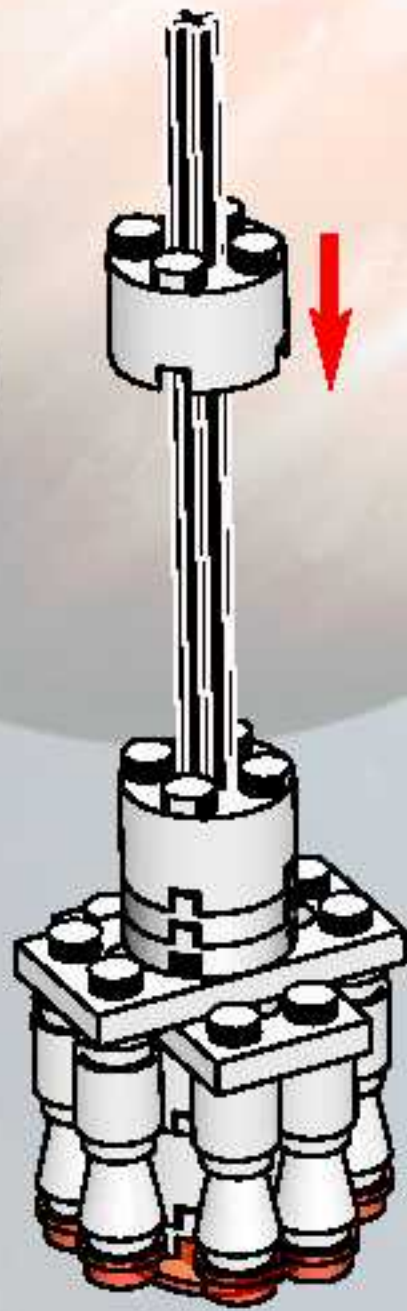

8

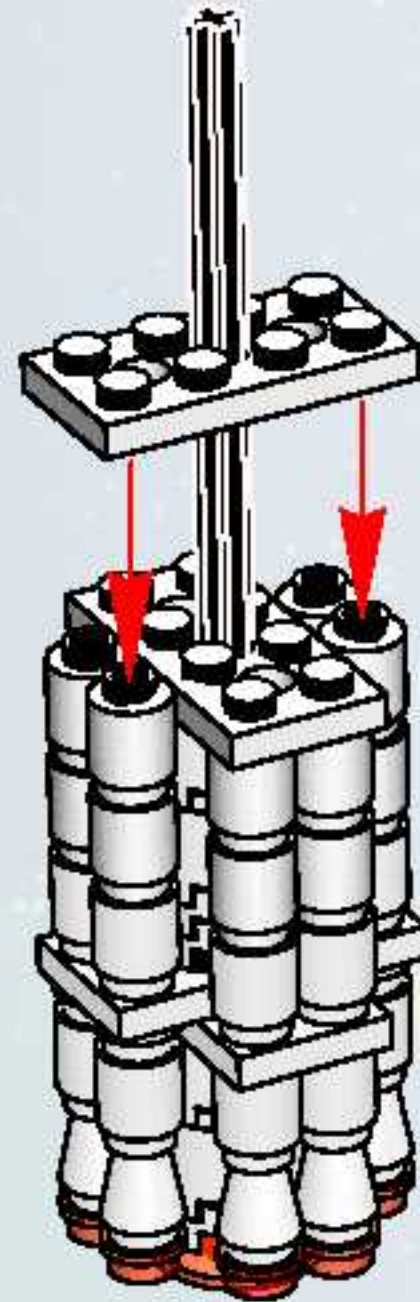

7

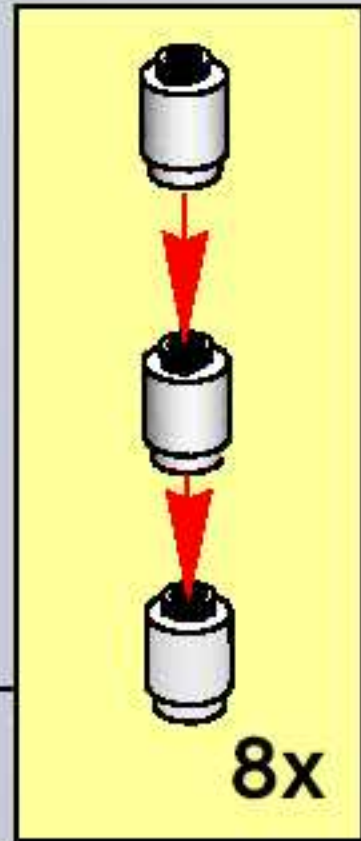
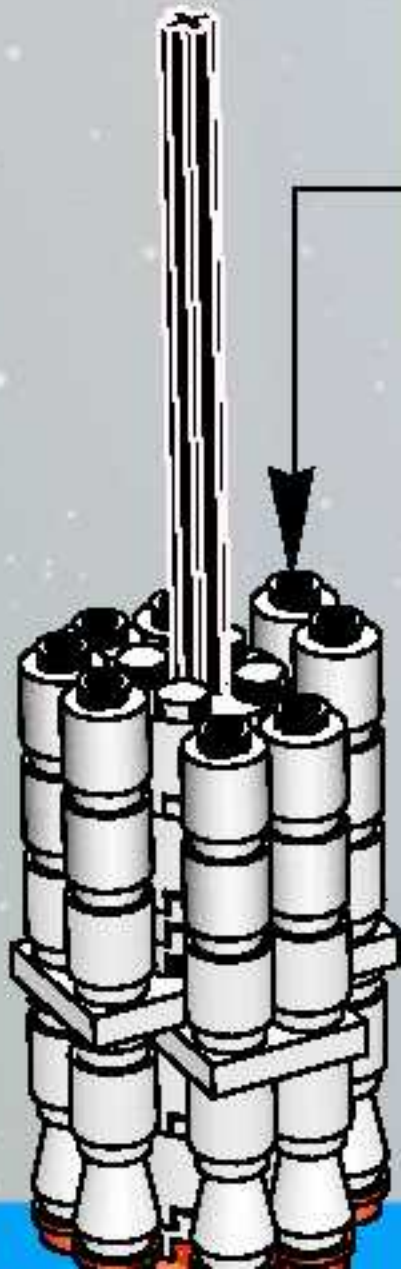

9

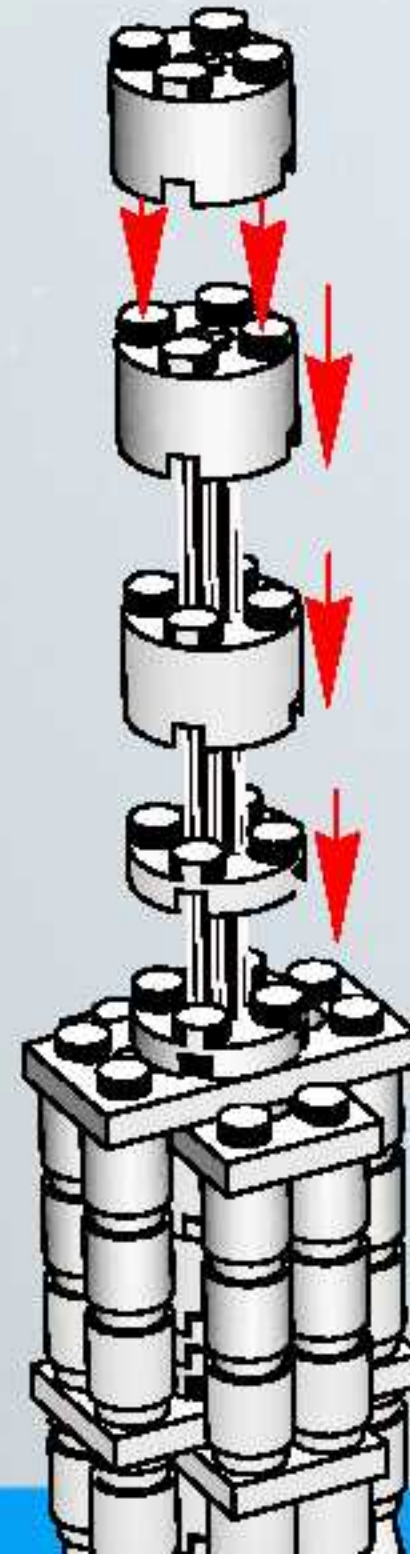

10

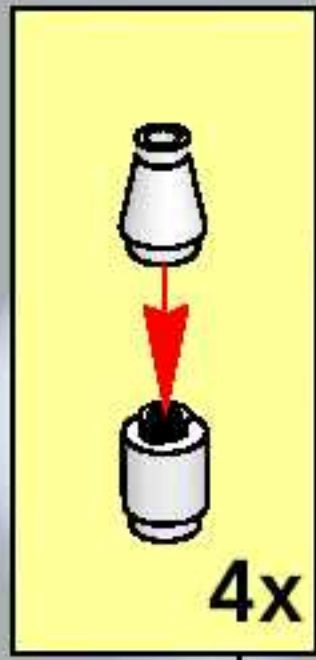
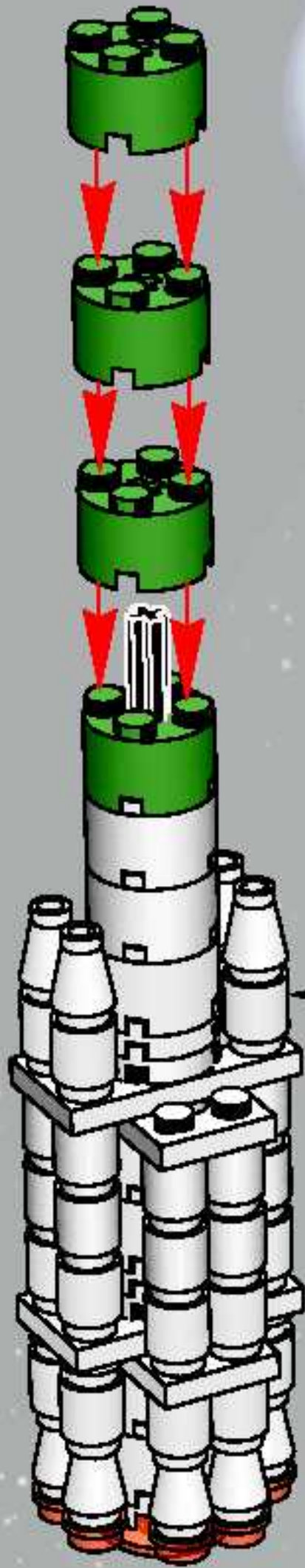

11

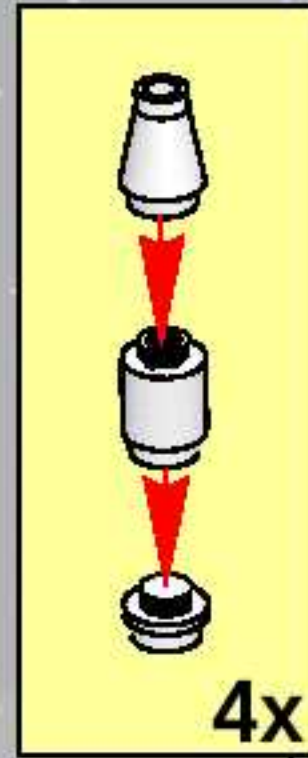

12

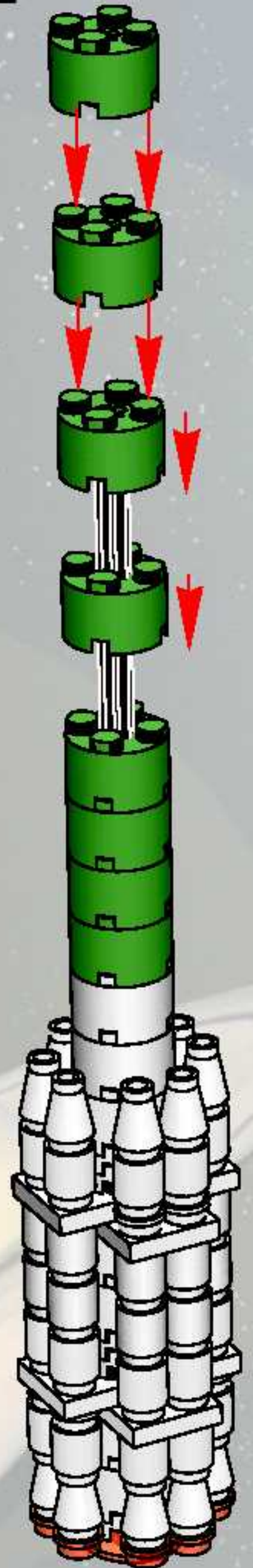

13

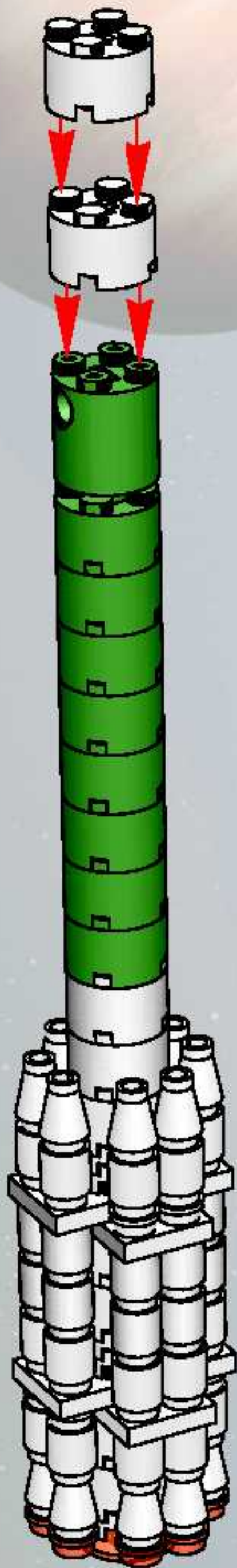

14

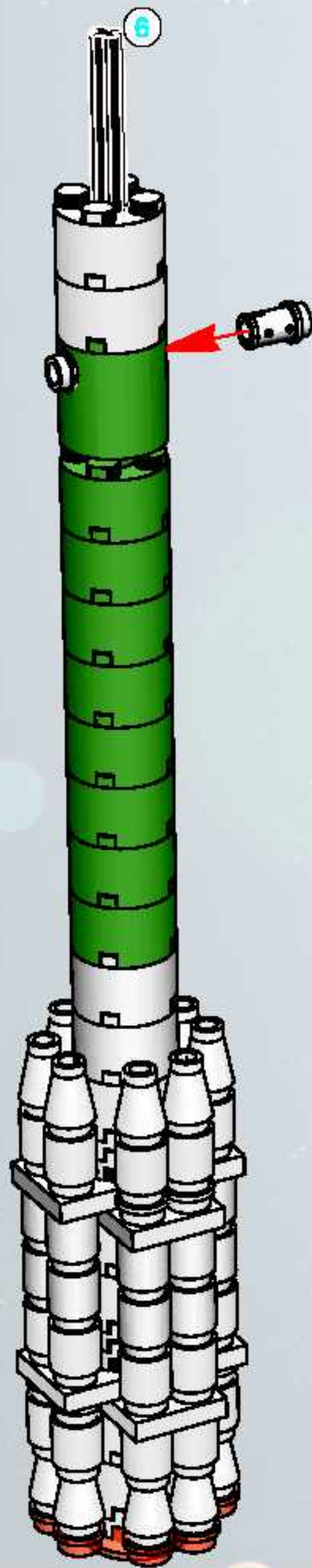

15

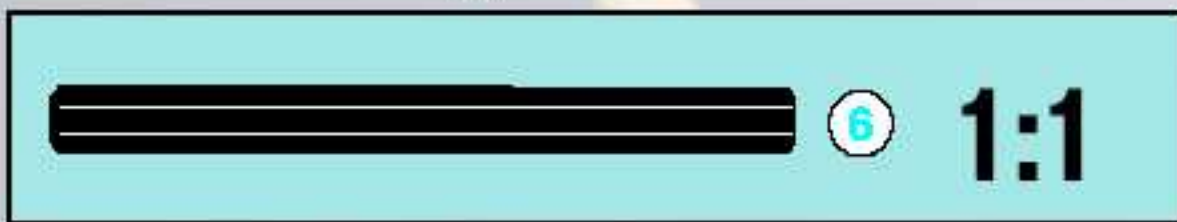
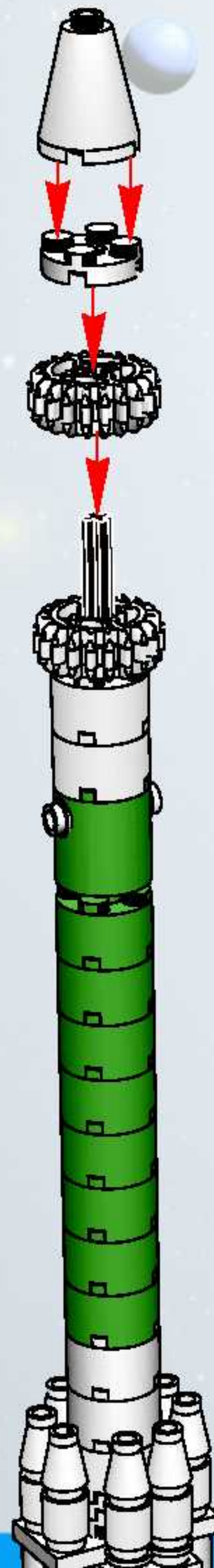

16

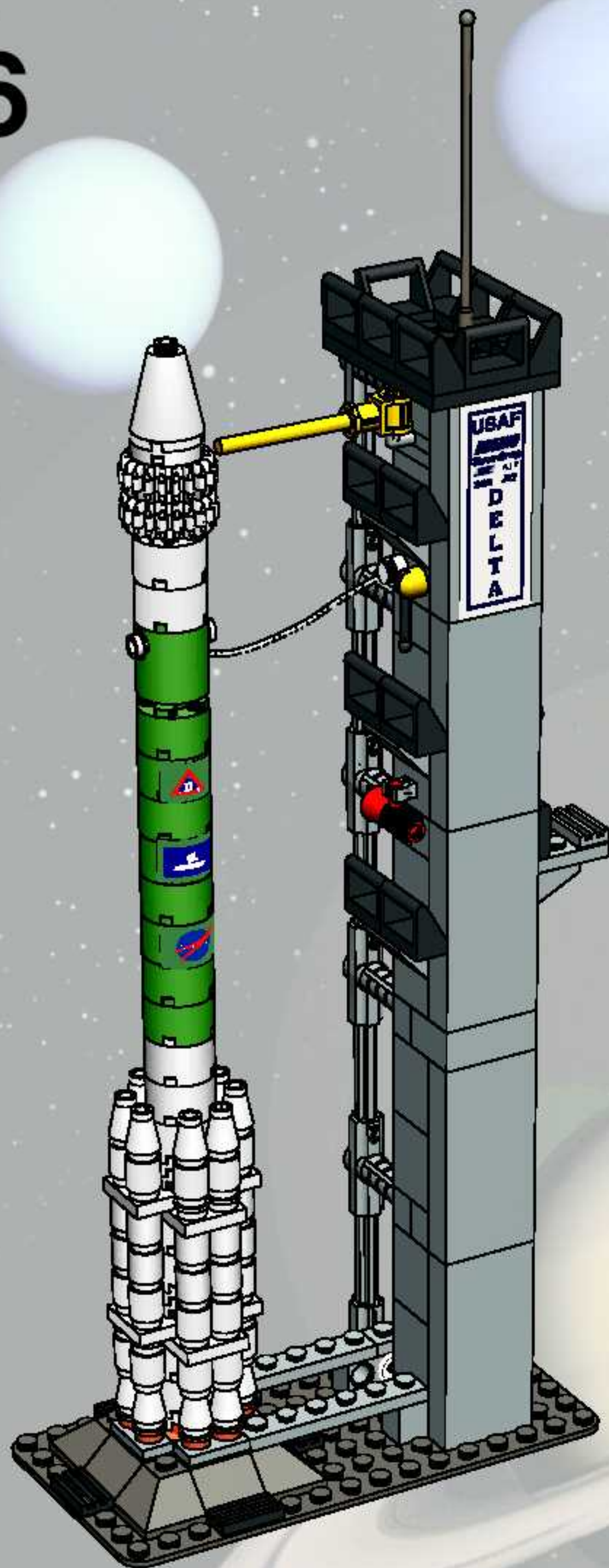



7470 SPACE SHUTTLE DISCOVERY



7468 SATURN V MOON MISSION



7469 MISSION TO MARS



7471 MARS EXPLORATION ROVER



7467 INTERNATIONAL SPACE STATION

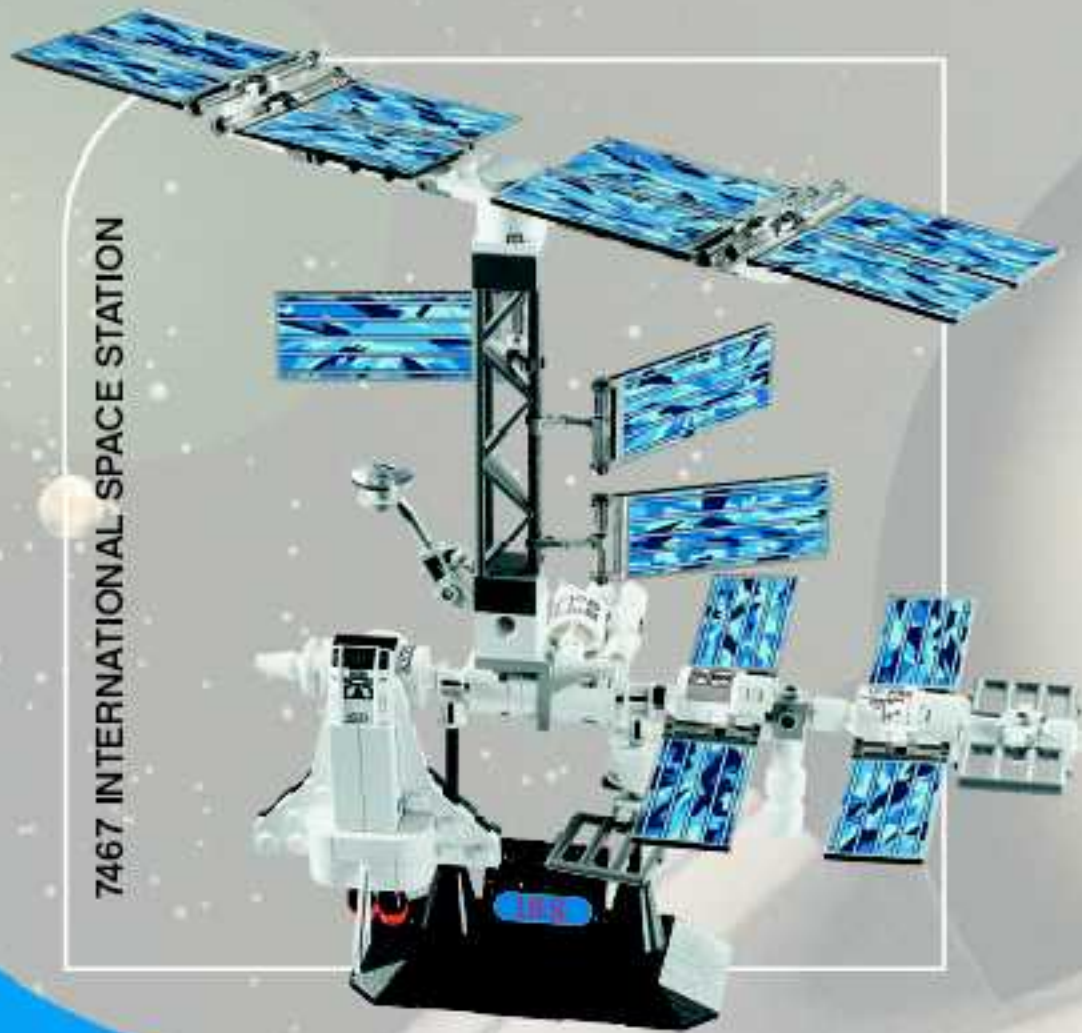

Win! Gagne! Gewinne! 当たります



Win LEGO® products

We would really like to know what you think about your new LEGO® product.

If you could help us by answering a few questions at www.acnielsen.aim.dk/lego then you are in with a chance of winning an exciting LEGO prize.

It will only take you about 3 minutes!



Estimado usuario LEGO®

Al contestar algunas preguntas en inglés, francés, alemán o japonés, en el sitio www.acnielsen.aim.dk/lego, podrás participar en el sorteo de algunos valiosos premios LEGO®.



Gagne des produits LEGO®

Nous aimerions beaucoup savoir ce que tu penses de ton nouveau produit LEGO®.

Si tu veux bien nous aider en répondant à quelques questions sur www.acnielsen.aim.dk/lego, tu recevras peut-être bientôt l'un des nombreux super-prix offerts par LEGO aux participants.

Et cela ne te prendra que 3 minutes environ !



Kedves Ifjú LEGO® Vásárló

Ha ellátogatsz a www.acnielsen.aim.dk/lego honlapra és ott angol, francia, német vagy japán nyelven megválaszolsz néhány kérdést, akkor részt veszel egy versenyben, amelyben értékes LEGO® díjakat nyerhetsz.



Gewinne LEGO® Produkte

Wir sind sehr an deiner Meinung über dein neues LEGO® Produkt interessiert.

Wenn du uns den Gefallen tust und unter www.acnielsen.aim.dk/lego Fragen beantwortest, kannst du einen tollen LEGO Preis gewinnen.

Das Ganze dauert nur etwa 3 Minuten!



Caro Consumidor da LEGO®

Ao responder a algumas perguntas em Inglês, Francês, Alemão ou Japonês no endereço www.acnielsen.aim.dk/lego irá participar num concurso para ganhar valiosos prémios da LEGO®.



抽選でレゴ製品が当たります

私たちは、皆さんがレゴ製品についてどんな感想をお持ちか、是非知りたいと思っています。

www.acnielsen.aim.dk/legoにアクセスいただき、質問にご回答いただきますと、抽選で楽しいレゴ製品が当たります。

アンケートのご回答には、ほんの3分ほどしかかかりません!

84090



LEGO and the LEGO logo are trademarks of the LEGO Group.
©2003 The LEGO Group.

 www.LEGO.com

© 2003 Discovery Communications, Inc. All rights reserved. Discovery Channel, logo and Explore Your World! are trademarks of Discovery Communications, Inc.