

LEGO

SPORTS

3584



NBA





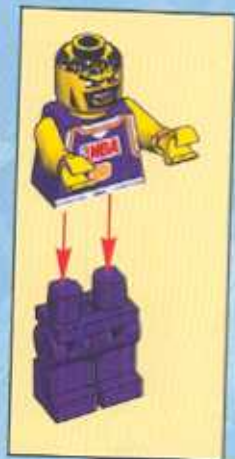

1

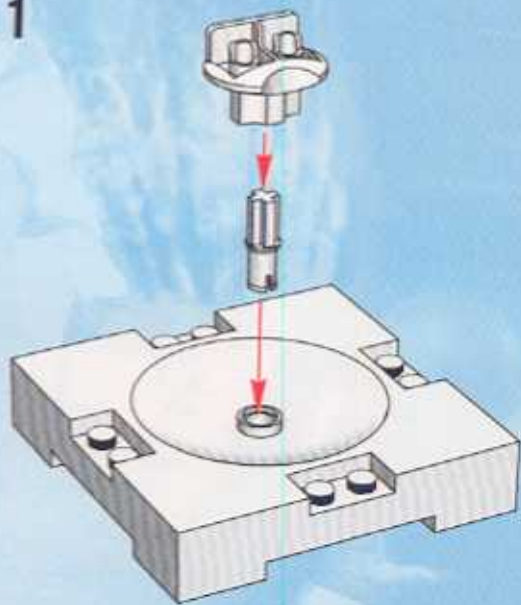

2



3



4

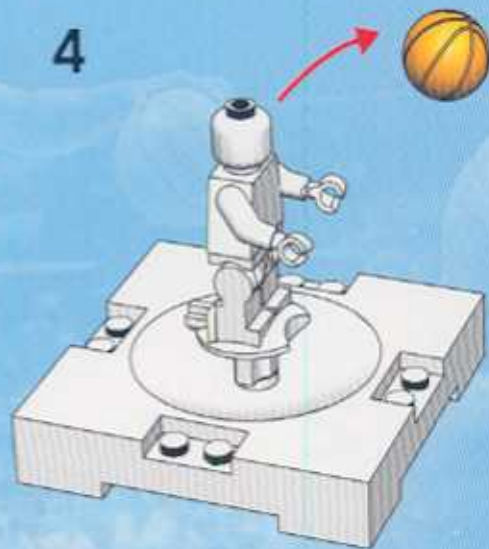

1

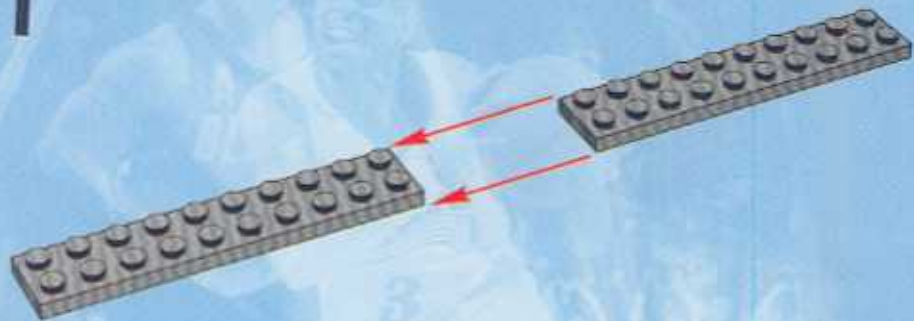

2



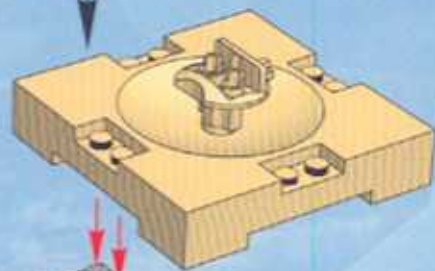
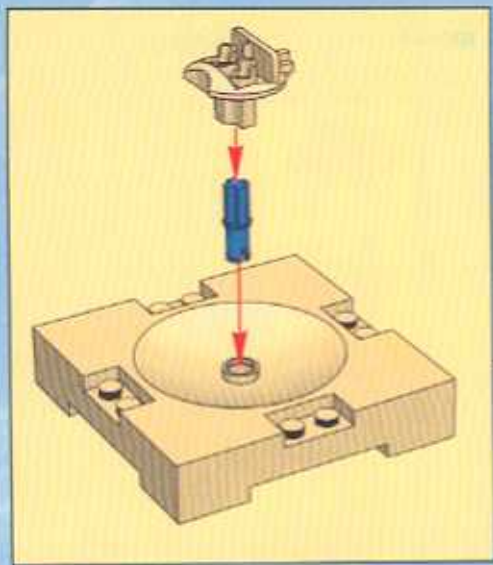

3

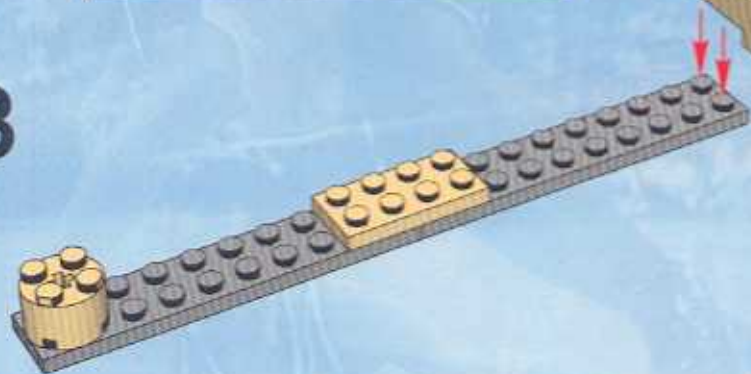

4

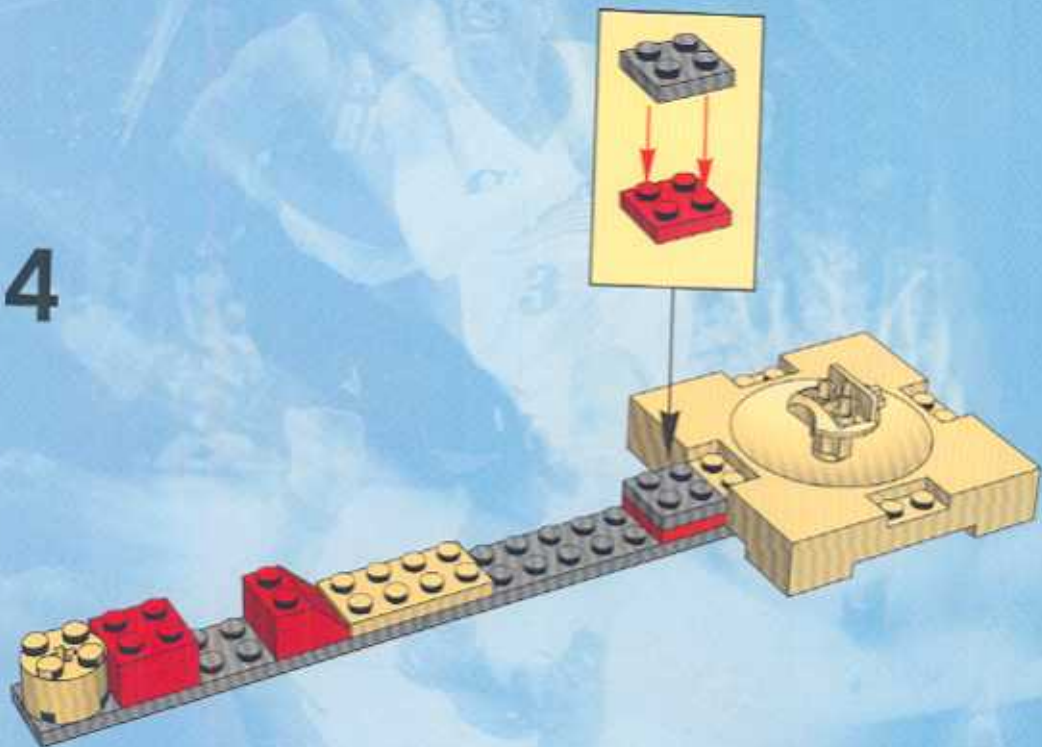

5

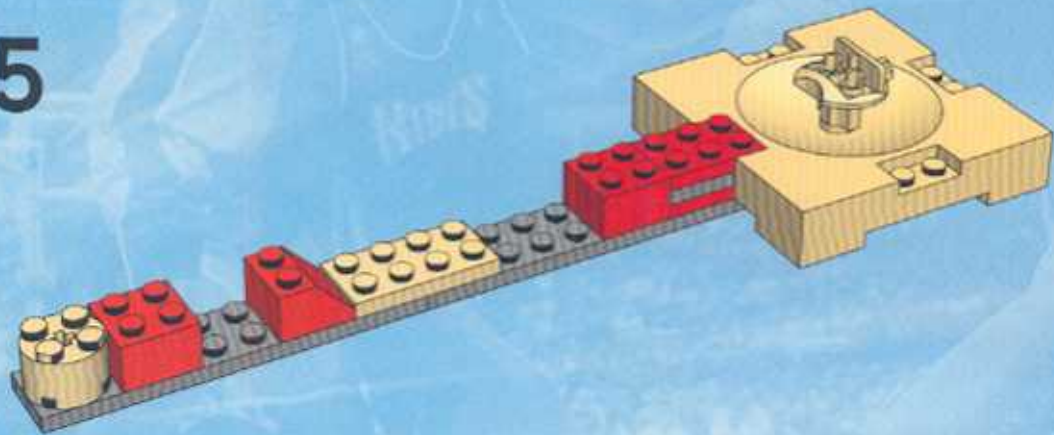

6

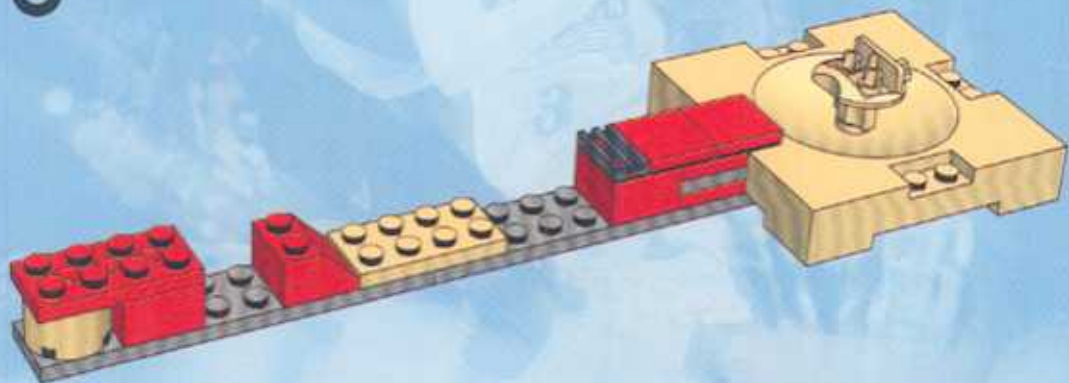

7

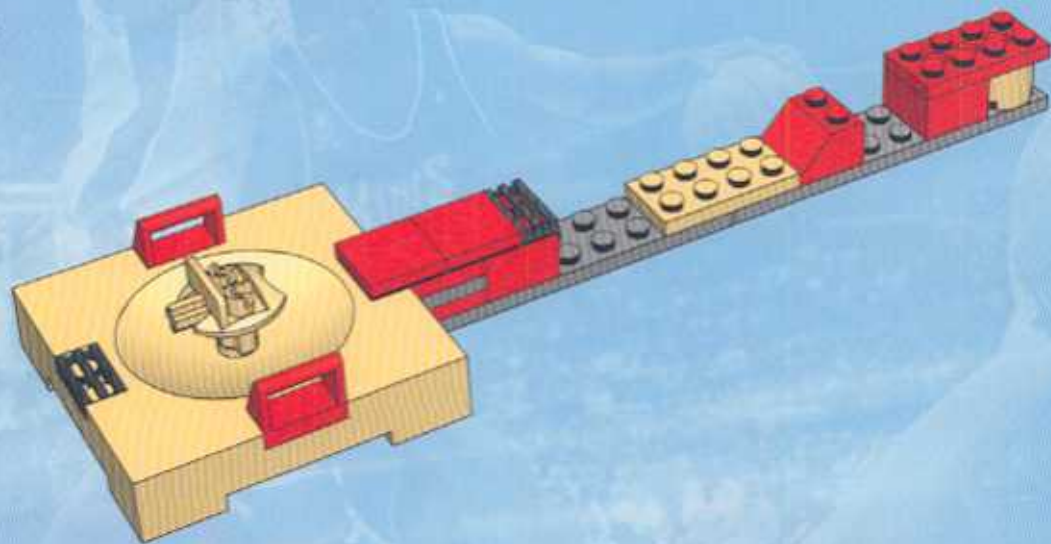

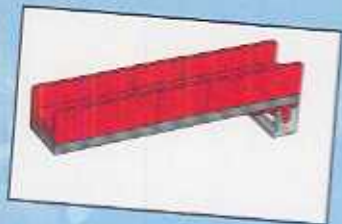

1



2

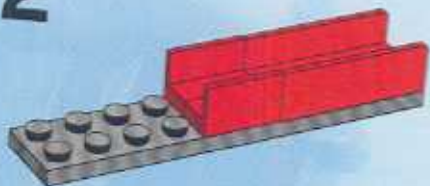

3



4



8

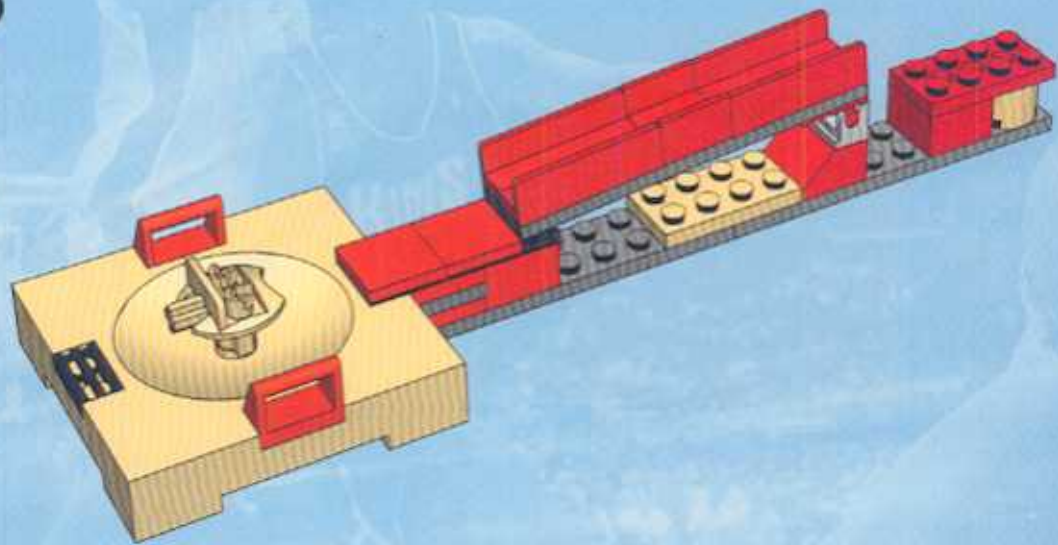

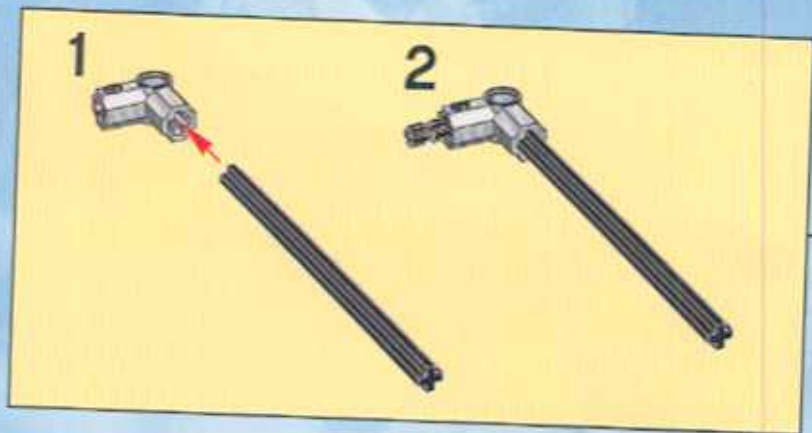

9

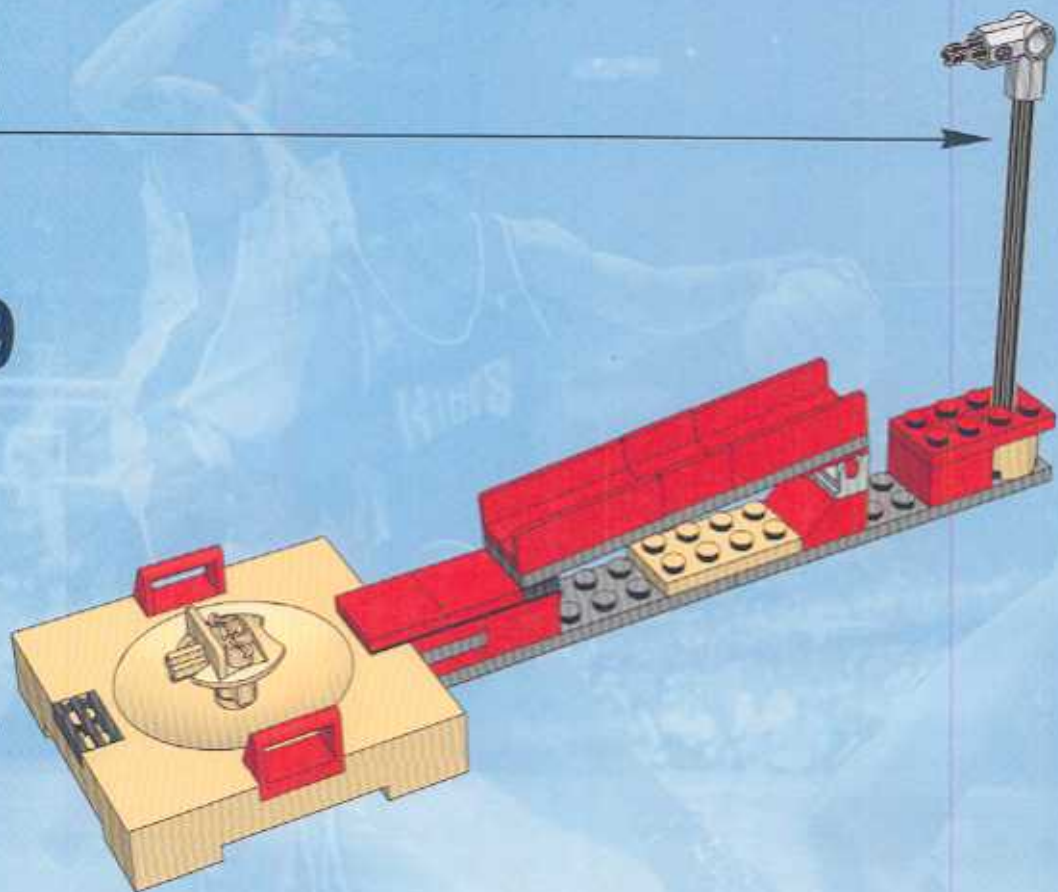

1



2



3



4



5



6

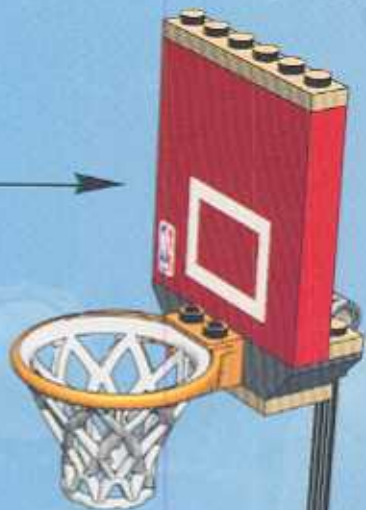

10

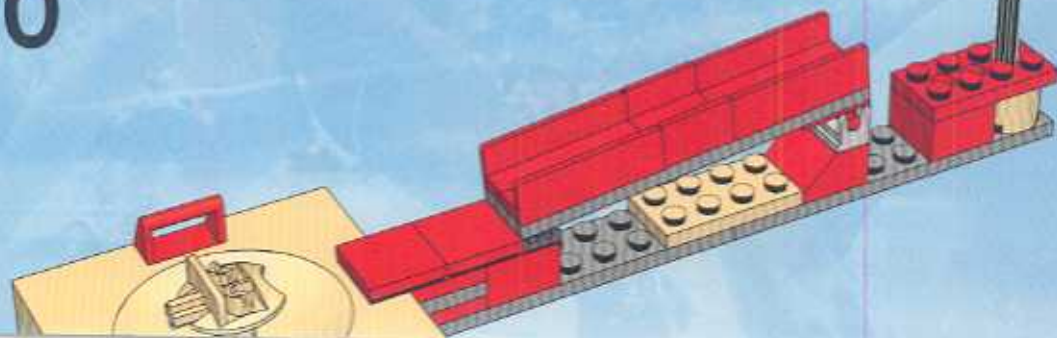

11

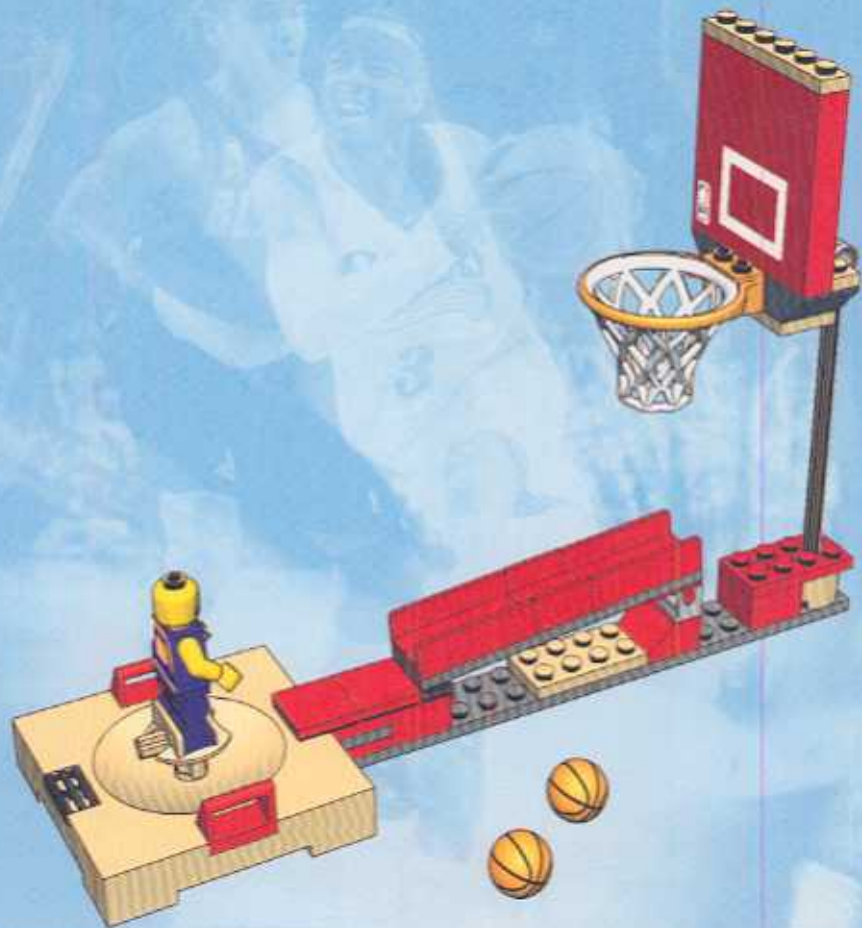



LEGO



www.LEGO.com

NBA.COM

NBA



#3428



3584+3427

1

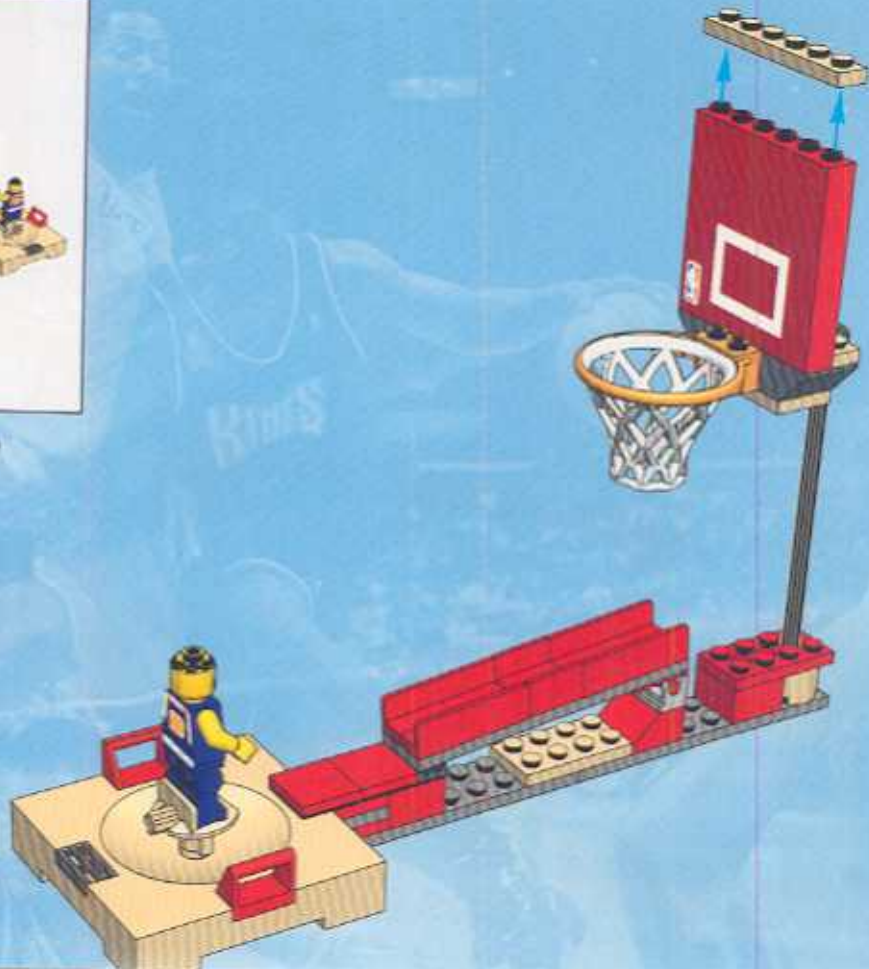

2

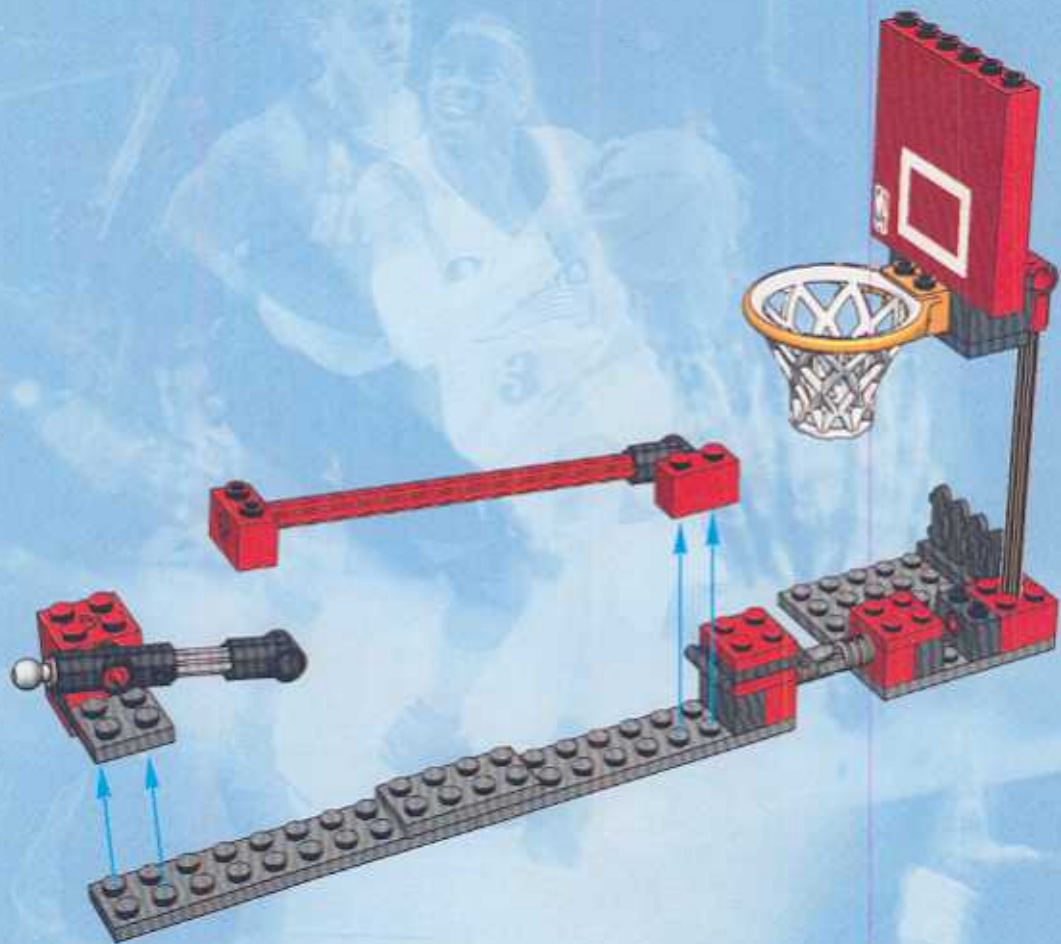

3

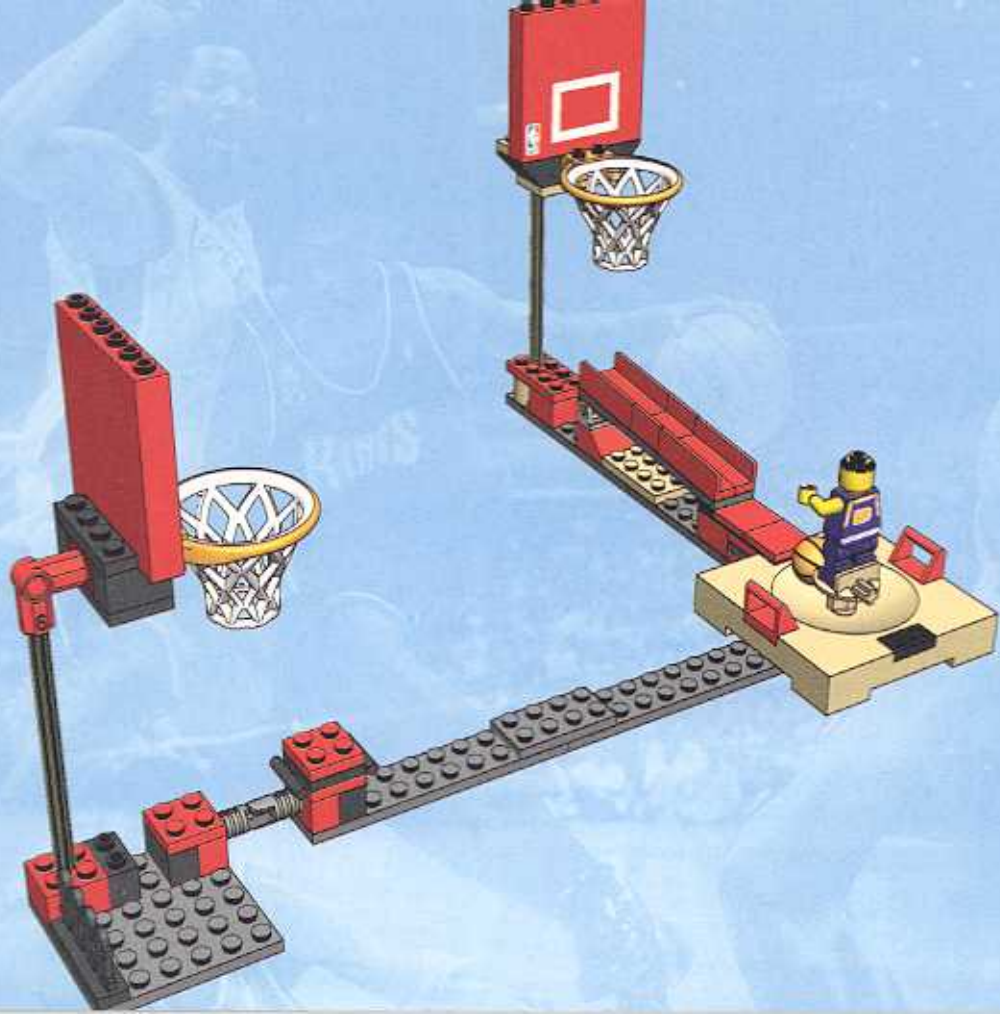

LEGO

SPORTS



adidas, the adidas logo and the three stripe trademark are registered trademarks of the adidas-Salomon group, used with permission. Fevernova and the Trigon logo are trademarks of the adidas-Salomon group, used with permission.

www.LEGO.com

SPALDING is a trademark of Spalding Sports Worldwide, Inc. or Lisco Sports, Inc., a Spalding affiliate. © Spalding Sports Worldwide, Inc. 2002

NBA identifications depicted are the exclusive property of NBA Properties, Inc. and/or the NBA Member Teams, and are used with permission.

LEGO and the LEGO logo are trademarks of the LEGO Group. ©2002 The LEGO Group.



SERVICE
www.lego.com